

BK PRECISION[®]

USER MANUAL

8500 SERIES DC ELECTRONIC LOADS

Models 8500, 8502, 8510, 8512, 8514, 8518, 8520, 8522, 8524 & 8526



Safety

The following general safety precautions must be observed during all phases of operation of this instrument. Failure to comply with these precautions or with specific warnings elsewhere in this manual violates safety standards of design, manufacture, and intended use of the instrument. B&K Precision assumes no liability for the customer's failure to comply with these requirements.

Verify that all safety precautions are taken. Note the instrument's external markings described under "Safety Symbols".

This product is a Safety Class 1 instrument, which means it is provided with a protective earth terminal. To minimize shock hazard, the instrument chassis and cover must be connected to an electrical ground. The instrument must be connected to the AC line power through a grounded power cable, with the ground wire firmly connected to an electrical ground (safety ground) at the power outlet. Note: Any interruption of the protective (grounding) conductor or disconnection of the protective earth terminal will cause a potential shock hazard that could result in personal injury.

DO NOT OPERATE THE INSTRUMENT IN AN EXPLOSIVE ATMOSPHERE OR IN THE PRESENCE OF FUMES OR FLAMMABLE GASES.

KEEP AWAY FROM LIVE CIRCUITS.

Operating personnel must not remove instrument covers. Component replacement and internal adjustments must be made only by qualified service personnel. Do not replace components with the power cable connected. Under certain conditions, dangerous voltages may exist even with the power cable removed. To avoid injuries always disconnect power, discharge circuits and capacitors, and remove external voltage sources before touching components.

DO NOT SERVICE OR ADJUST ALONE.

Do not try to perform internal service or adjustment unless another person capable of rendering first aid and resuscitation is present.

Safety Symbols

Note the instrument's external markings as follows:







	Direct current
	Alternating current
	Both direct and alternating current
	Protective earth (ground) terminal
	Caution (refer to accompanying documents)
	The WARNING sign denotes a hazard. It calls attention to a procedure, practice, or the like which, if not correctly performed or adhered to, could result in personal injury. Do not proceed beyond a WARNING sign until the indicated conditions are fully understood and met.
	The CAUTION sign denotes a hazard. It calls attention to an operating procedure, or the like, which, if not correctly performed or adhered to, could result in damage to or destruction of part or all of the product. Do not proceed beyond a CAUTION sign until the indicated conditions are fully understood and met.

Table of Contents

Safety.....	2
Safety Symbols.....	2
Notation.....	5
Quick reference.....	6
Model numbers covered by this document.....	6
Options and accessories.....	6
Overview of instrument.....	6
Typical tasks.....	7
Front panel.....	7
Standard display.....	9
Front panel keys.....	9
Rear panel.....	10
Power Requirements.....	11
Display annunciators.....	11
Menus.....	12
Specifications.....	16
Environmental Conditions	18
Internal Resistances.....	18
Operational power curve.....	19
Low Voltage Characteristics.....	20
Slew rate.....	21
Glossary.....	23
Installation.....	25
Inspection.....	25
Items you should have received.....	25
Instrument location.....	25
Outline Drawings.....	25
Bench operation.....	28
First turn-on checkout.....	29
Operational introduction.....	30
Power-on state.....	31
Constant current mode.....	32
Constant voltage mode.....	32
Constant power mode.....	32
Constant resistance mode.....	33
Timed operation.....	33
Changing display resolution.....	34
Increasing current resolution.....	34
Increasing voltage resolution.....	34
Short.....	34
Battery test.....	34
Transient operation.....	35
Continuous transient operation.....	35
Pulse transient operation.....	36
Toggled transient operation.....	37
Toggle between two test values.....	38
Lists (dynamic condition).....	38
Test files.....	40
Triggering.....	42

Voltage threshold operation.....	42
Passwords.....	43
Protection features.....	43
Over Voltage protection.....	43
Over Current protection.....	43
Over Power protection	44
Reverse voltage protection.....	44
Over Temperature protection.....	44
Remote sensing.....	44
Saving and Recalling settings.....	45
Remote operation.....	46
Communication cables.....	46
USB to TTL serial converter cable IT-E132B.....	46
USB (Virtual COM) settings.....	46
Overview of DC Load programming.....	46
Packet structure.....	46
Status packets.....	47
Chapter organization.....	50
Summary of commands.....	50
Command details.....	53
Serial number and firmware version.....	70
In case of trouble.....	71
Instrument won't turn on.....	71
Error messages during power-up.....	71
Keypad unlock procedure (Keypad was accidentally locked).....	71
Frequency Asked Questions.....	72
Appendix: Service and warranty information.....	74
Index.....	75

Notation

I-set	Represents a key on the front panel. Note that some of these may be accessed in combination with the Shift key.
OFF	Annunciator, value, or message shown on the vacuum fluorescent display.
CONFIG	Menu item
OFF	Default menu item

Quick reference

Model numbers covered by this document

The B&K Precision DC Loads covered by this manual are:

- 8500
- 8502
- 8510
- 8512
- 8514
- 8518
- 8520
- 8522
- 8524
- 8526

Unless otherwise noted, this document will refer to all of these instruments as the DC Load. Instrument differences, where appropriate, will be noted.

Options and accessories

The items included with the instrument are:

1. Power cord
2. User manual
3. Installation CD with application software PV8500 and USB driver for TTL to USB adapter
4. TTL to USB serial adapter IT-E132B
5. Test report

Optional accessories are:

6. rack mount kit IT-E151 (available for models 8500, 8502, 8510, 8512, 8514, 8518)

Overview of instrument

The DC Load is a two terminal device that can be connected to DC sources. Here, a DC source is a voltage that is always positive on the DC Load's + terminal referenced to the - terminal.

DC Electronic Loads are used for design, manufacturing and evaluation of DC power supplies, batteries, and power components. Other applications include fuel-cell and photovoltaic cell test. The DC Load can operate under the following modes:

- Draw a constant voltage from a DC source.
- Draw a constant current from a DC source.
- Draw a constant power from a DC source.
- Present a constant resistance to the DC source (this behavior simulates a perfect resistor whose resistance doesn't change as a function of current or voltage).

The DC Load can present dynamically changing loads to the DC source with millisecond switching times. The DC Load can be remotely programmed via a serial interface (USB virtual COM). Versatile triggering options allow the dynamic load behavior to be synchronized with other events.

A battery test mode is provided that will measure the ampere*hour (A*hr) characteristic of a battery. Shorts can be simulated by either the front panel or custom programming. The DC source or other components can be protected from excessive voltage, current, or power, which will cause the DC Load to shut down if excessive levels or reverse polarity are detected.

Dynamic profiles and last instrument states can be stored in non-volatile memory.

The DC Load is a versatile instrument for static and dynamic testing of power supplies, batteries, DC to DC converters, and battery chargers.

Typical tasks

To perform the following tasks, consult the indicated sections

Task	Section(s)
Manual on/off CC, CV, CW, or CR test	<i>Constant current mode</i> <i>Constant voltage mode</i> <i>Constant power mode</i> <i>Constant resistance mode</i>
Timed on/off CC, CV, CW, or CR test	<i>Constant current mode</i> <i>Constant voltage mode</i> <i>Constant power mode</i> <i>Constant resistance mode</i> <i>Timed operation</i>
Triggered CC, CV, CW, or CR test	<i>Constant current mode</i> <i>Constant voltage mode</i> <i>Constant power mode</i> <i>Constant resistance mode</i> <i>Triggering</i>
Constant load with one transient	<i>Transient operation</i>
Load with multiple transients	<i>Lists (dynamic condition)</i>
Determine A*hr characteristic of battery	<i>Battery test</i>
Run a sequence of tests	<i>Test files</i>

Front panel

The following picture is the front panel for the 8510 DC Load. All models have the same front panel, only the terminal section will vary based on the model.

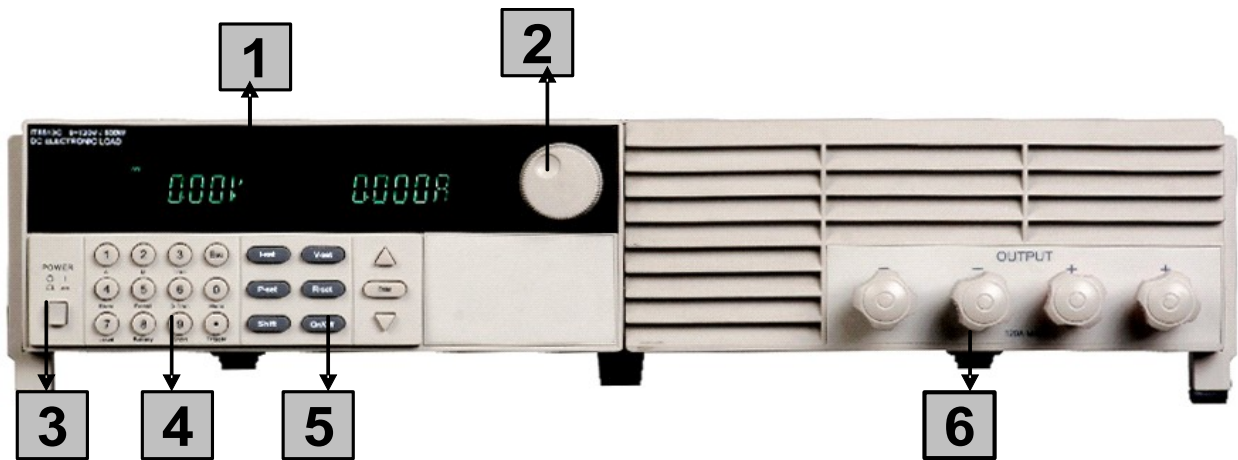

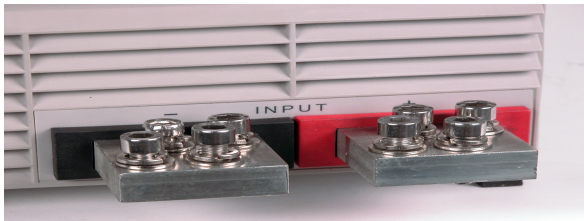
Button	Function(s)
	16-character display shows voltage and current measurements.
	Rotary knob. Turn to adjust a setting value. Press in to toggle between setting the currently-selected mode's value and reading the voltage and current, as shown in the above picture.
	Power switch to turn the instrument on or off.
	Numeric keypad: Numeric entry keys. Secondary key functions.
	Keypad: Enable/disable input. Set up the current, voltage, power, and resistance modes. Scroll through menus and options.
	<p>Input terminals. Depending on the model, you will have different types and numbers of input terminals.</p> <p><u>Models 8500/8502</u> come with one plus and one minus terminal</p> <p><u>Models 8510/8512</u> come with two positive and two negative terminals however each terminal is able to sink the maximum current supported by the instrument. Thus, it is not necessary to double up on the wires when sinking a high current unless you wish to.</p> <p><u>Models 8514/8518</u> also come with two positive and two negative terminals however it is required to double up on the wires when sinking a current exceeding 120A.</p> <p><u>Models 852x</u> come with a screw terminal block to connect the wires</p> 

Standard display

The standard display for the instrument is the voltage and current at the instrument's terminals. You may press the Δ or ∇ keys to see the instantaneous power and the mode's parameter setting.

Standard display



Front panel keys

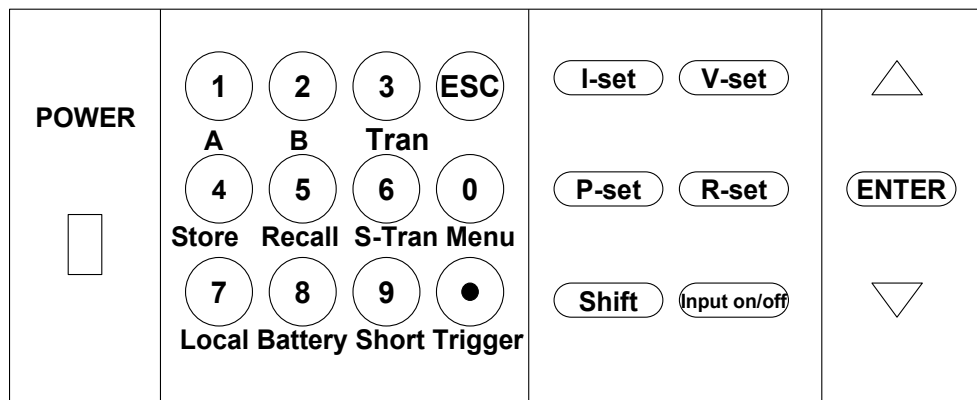

V-set	Choose constant voltage mode.
I-set	Choose constant current mode.
P-set	Choose constant power mode.
R-set	Choose constant resistance mode.
Shift + A	Set the current mode's load value from the A value of the corresponding transient operation. See the Transient operation section. This key does not work when the TRAN annunciator is on.
Shift + B	Set the current mode's load value from the B value of the corresponding transient operation. See the Transient operation section. This key does not work when the TRAN annunciator is on.
Shift + Store	Store the DC Load state in non-volatile memory. You may store 25 different states.
Shift + Recall	Recall the DC Load state from non-volatile memory. You may recall 25 different states.

Shift + Menu	Enter the instrument's menu system.
Shift + Short	Turn short circuit on or off.
Shift + Tran	Start or stop transient condition.
Shift + Trigger	Causes an immediate trigger.
Shift + Battery	Turn on or off battery testing function (measures battery capacity in ampere*hours).
Shift + S-Tran	Set transient condition parameters.
On/Off	Turns DC Load ON or OFF (OFF is high impedance state).
Shift	The shift key is used to select the alternate operation of a key, indicated by the word under the key.
▲	Scroll up key.
▼	Scroll down key.
0 to 9	Enter the digits 0 to 9.
.	Decimal point.
Esc	The escape key. It can be used to exit keyboard entry or move up a level in the menu.
Enter	Enter the selected value or setting.

Rear panel

Your instrument's rear panel may look different from the following figure, but the same functionality will be present.

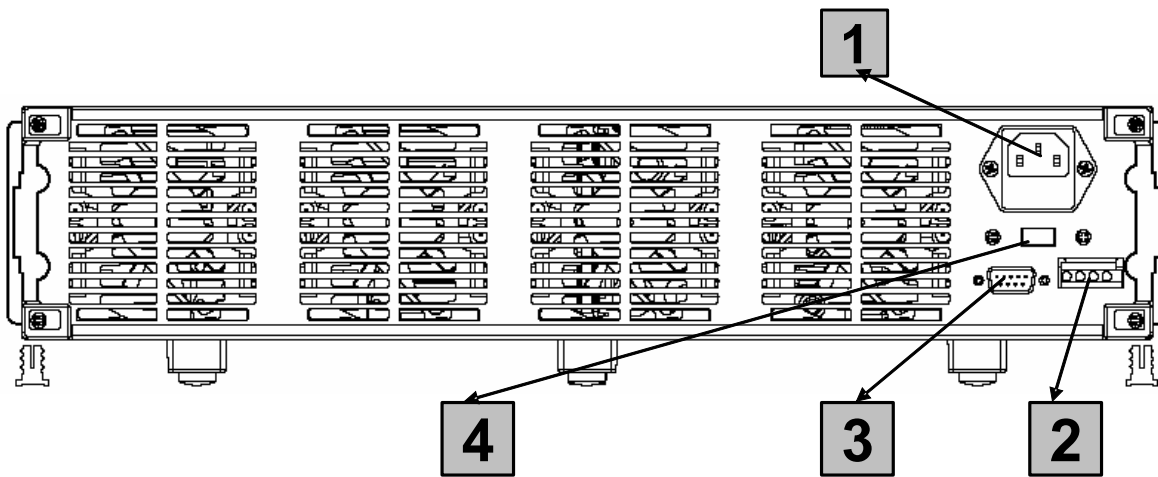

1	3 pin IEC320 AC input connector.
2	4 pin trigger and remote sensing connector.
3	9-Pin serial port interface connector. NOTE: This port's terminals utilize 5 volt TTL logic signals. <u>Do NOT connect an RS-232 cable with standard RS-232 voltages on the cables connectors.</u> Doing so may damage the instrument and is

	not covered by warranty.
4	Line voltage selection switch (110 VAC or *220 VAC) *For models 8524 and 8526, the line voltage switch is not usable and does not allow for 220VAC operation. Do not connect them directly into a 220V line. For 220V operation, please order model 8524-220V or 8526-220V.

Power Requirements

All of the models, except for models 8524 and 8526, can accept 110V or 220V line input. To switch between the two line voltage inputs:

1. Verify and change the fuse inside the fuse box beneath the AC input receptacle. See fuse section for reference to the fuse type and rating.
2. Flip the 110V/220V line selection switch in the rear panel of the instrument.

WARNING:

Models 8524 and 8526 are configured for 110 V operation only. These two models are not configurable via the line switch on the rear panel. Connecting an AC line input of a 8524 and 8526 to a 220V AC source will damage the units. If 220 V operation is desired, order model 8524-220V or 8526-220V. “-220V” denotes 220 V operation only, reconfiguration to 110 V is not possible.

Display annunciators

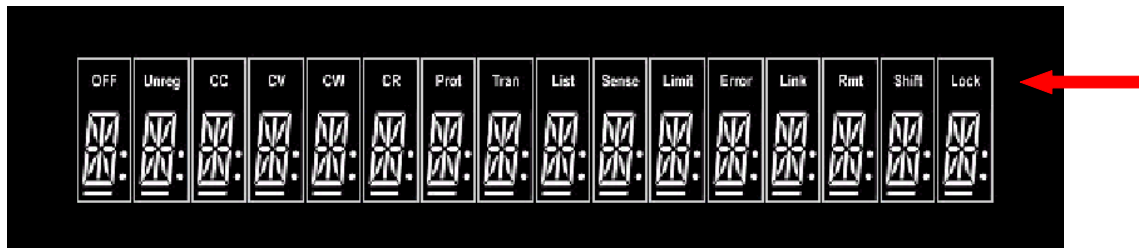

Annunciator	Meaning
OFF	The load is off.
UNREG	The input is unregulated.
CC	Constant current mode.
CV	Constant voltage mode.
CW	Constant power mode.
CR	Constant resistance mode.
PROT	Not used.
TRAN	Transient operation is enabled.
LIST	List mode is initiated or running.
SENSE	Remote sensing is on.

Annunciator	Meaning
LIMIT	Not used.
ERROR	An error has occurred.
LINK	The instrument is communicating with an IT-E132B communications adapter. This annunciator will stay lit for approximately 3 seconds after the last remote communication with the DC Load.
RMT	Instrument is in the remote state. The only active key is the Local key. This is set with the 0x20 remote command (see the Remote programming section).
SHIFT	The Shift key has been pressed.
LOCK	The keyboard is locked by a password.

Menus

Use **Shift + 0 (Menu is secondary function)** to enter the menus. “Lvl” indicates the menu level, which is also indicated by the indentation of the menu item text. Scroll through the menu items using the **▲** and **▼** keys. Return to a previous menu level by pressing the **Esc** key. Words in the heavy font such as **OFF** indicate the default menu selection.

Lvl	Menu item	Function
1	CONFIG	
2	INITIAL CONFIG	Return instrument to factory default settings.
2	POWER-ON RECALL	Power on state of instrument.
3	ON	Remembers state at last power-down.
3	OFF	Does not remember state at last power-down.
2	INPUT RECALL	Remember whether load was ON
3	ON	If load was ON prior to turning the power off, the ON state will be resumed after power on. POWER-ON RECALL must also be on for this to work.
3	OFF	After power on, the instrument will be in the OFF state.
2	KEY SOUND SET	
3	ON	Enable audible beep when key is pressed.
3	OFF	No sound when key is pressed.
2	KNOB LOCK SET	
3	ON	Rotary knob is non-functional.
3	OFF	Rotary knob is functional.
2	SHORT CUT RECALL	Quickly recall a setup register by pressing a number key.
3	ON	Allows quick recall of a setup by pressing the number key.
3	OFF	Pressing a number key does not recall a setup.
2	RANGE SELECT	Change the precision of displayed values.
3	ON	Allows the user to select the instrument's range, giving better voltage and/or current resolution. Press Shift + ▲

Lvl	Menu item	Function
		or Shift +  to toggle resolutions.
3	OFF	Current and voltage measurement resolution are fixed.
2	REMOTE SENSE	See the <i>Remote sense</i> section.
3	ON	Remote sensing is on.
3	OFF	Remote sensing is off.
2	ADC UPDATE RATE	Set the rate at which the display is updated.
3	HIGH	
3	LOW	
2	TRIGGER SOURCE	How the instrument is triggered.
3	IMMEDIATE	Triggered from the Shift + Trigger key.
3	EXTERNAL	Triggered from a TTL high signal (longer than 5 ms) at the trigger connector on rear panel.
3	BUS	Triggered from a serial bus command.
2	CONNECT MODE	
3	MAXTIPLEXING	Not supported with this hardware. (Should actually say "multiplexing".)
3	SEPARATE	
2	BAUDRATE SET	Set the serial bus connection speed.
3	4800	
3	9600	
3	19200	
3	38400	
2	COMM. PARITY SET	Serial connection parity.
3	NONE	
3	EVEN	
3	ODD	
2	ADDRESS SET	Set the instrument's address. Must be an integer between 0x00 and 0xFE inclusive.
2	KEY LOCK SET	Set the instrument's password to 1 - 4 digits. Press the Enter key without any data entry to remove the password. <u>If you accidentally locked the keyboard, follow instructions at the end of this manual, chapter "in case of trouble" to unlock the keypads.</u>
2	EXIT	Return to prior menu level.
1	SYSTEM SET	
2	MAX CURRENT SET	Set the maximum allowed current. Exceeding this value will cause the load to shut off. This value also becomes the maximum current you can set.
2	MAX POWER SET	Set the maximum allowed power. Exceeding this value will cause the load to shut off. This value also becomes the maximum power you can set.

Lvl	Menu item	Function
2	MAX VOLTAGE SET	Set the maximum allowed voltage. Exceeding this value will cause the load to shut off. This value also becomes the maximum voltage you can set.
2	VOLTAGE ON SET	Used to set an ON voltage threshold. See the Voltage threshold section. Default: 0.00 V
2	VOLTAGE OFF SET	Used to set an OFF voltage threshold. See the Voltage threshold section. Default: 0.00 V
2	EXIT	Return to prior menu level.
1	LIST SET	Lists are programmed sequences of load values.
2	MODE SET	
3	FIXED MODE	Load characteristics set by front panel.
3	LIST MODE	Load characteristics are dynamic and controlled by a list stored in memory.
2	CALL LIST FILE	Recall an existing list from nonvolatile memory.
3	RECALL N	N is list number.
2	EDIT LIST FILE	Note that each list file has four lists, one for each operation mode (CC, CV, CW, CR).
3	CURRENT LIST	
4	ONCE	List is executed once per trigger.
4	REPEAT	List is repeatedly executed after the trigger is received.
3	VOLTAGE LIST	
4	ONCE	List is executed once per trigger.
4	REPEAT	List is repeatedly executed after the trigger is received.
3	POWER LIST	
4	ONCE	List is executed once per trigger.
4	REPEAT	List is repeatedly executed after the trigger is received.
3	RESISTANCE LIST	
4	ONCE	List is executed once per trigger.
4	REPEAT	List is repeatedly executed after the trigger is received.
2	CALL TEST FILE	Recalls a stored test file (see Test files section).
3	RECALL N	N is file number.
2	EDIT TEST FILE	See Test files section for more details.
2	LIST STORE MODE	Set how the nonvolatile memory is partitioned to store lists. You can choose between numerous short lists or fewer longer lists.
3	8 X 120 STEPS	
3	4 X 250 STEPS	
3	2 X 500 STEPS	
3	1 X 1000 STEPS	
2	EXIT	Return to prior menu level.
1	LOAD ON TIMER	Enable a timed load.
2	TIMER STATE	

Lvl	Menu item	Function
3	ON	When the load timer is enabled by this menu element, the load is turned on when the On/Off key is pressed. After the set time period has elapsed, the load is turned off.
3	OFF	When the load is turned on via the On/Off key, the load stays ON indefinitely.
2	TIMER SET	Set the time period from 1 to 60000 s for the load to be on.
2	EXIT	Return to prior menu level.
1	EXIT	Return to standard display.

Specifications

Models 8500 & 8502 (300 W)

Parameter		8500	8502
Input rating	Voltage	0 – 120 V	0 – 500 V
	Current	0 – 30 A	0 – 15 A
	Power	300 W	

8500/8502 common characteristics				
Parameter	Range		Accuracy	Resolution
	8500	8502		
CV Mode Regulation	0.1-18 V		$\pm(0.05\%+0.02\% \text{ FS})$	1 mV
	0.1 – 120 V	0.1 – 500 V	$\pm(0.05\%+0.025\% \text{ FS})$	10 mV
CC Mode Regulation	0 – 3 A	0 – 3 A	$\pm(0.1\%+0.1\% \text{ FS})$	0.1 mA
	0 – 30 A	0 – 15 A	$\pm(0.2\%+0.15\% \text{ FS})$	1 mA
Current Measurement	0 – 3 A	0 – 3 A	$\pm(0.1\% + 0.1\% \text{ FS})$	0.1 mA
	0 – 30 A	0 – 15 A	8500: $\pm(0.2\%+0.15\% \text{ FS})$ 8502: $\pm(0.2\%+0.3\% \text{ FS})$	1 mA
Voltage Measurement	0-18 V		$\pm(0.02\% + 0.02\% \text{ FS})$	1 mV
	0-120 V	0 – 500 V	$\pm(0.02\% + 0.025\% \text{ FS})$	10 mV

Models 8510/8512/8514/8518 (1200 & 2400 W)

Parameter		8510	8512	8514	8518
Input rating	Voltage	0 – 120 V	0 – 500 V	0 – 120 V	0 – 60 V
	Current	0 – 120 A	0 – 30 A	0 – 240 A	0 – 240 A
	Power	600 W		1200 W	

8510/8512/8514/8518 common characteristics						
Parameter	Range				Accuracy	Resolution
	8510	8512	8514	8518		
CV Mode Regulation	0.1-18 V				$\pm(0.05\%+0.02\% \text{ FS})$	1 mV
	0.1 V to Vmax				$\pm(0.05\%+0.025\% \text{ FS})$	10 mV
CC Mode Regulation	0-12 A	0-3 A	0-24 A		$\pm(0.1\%+0.1\% \text{ FS})$	1 mA
	0 – max Current				$\pm(0.2\%+0.15\% \text{ FS})$	10 mA
Current Measurement	0-12 A	0-3 A	0-24 A		$\pm(0.1\% + 0.1\% \text{ FS})$	1 mA
	0 – max. Current				$\pm(0.2\%+0.15\% \text{ FS})$	10 mA
Voltage Measurement	0 – 18 V				8510/8514: $(0.02\% + 0.025\% \text{ FS})$ 8512/8518: $(0.02\% + 0.02\% \text{ FS})$	1 mV
	0 - Vmax				$\pm(0.02\% + 0.025\% \text{ FS})$	10 mV

Models 8520/8522/8524/8526 (2400W & 5000W)

Parameter		8520	8522	8524	8526
Input rating	Voltage	0 – 120 V	0 – 500 V	0 – 60 V	0 – 500 V
	Current	0 – 240 A	0 – 120 A	0 – 240 A	0 – 120 A
	Power	2400 W		5000 W	

8520/8522/8524/8526 common characteristics						
Parameter	Range				Accuracy	Resolution
	8520	8522	8524	8526		
CV Mode Regulation	0.1-18 V				±(0.05%+0.02% FS)	1 mV
	0.1 V to Vmax				±(0.05%+0.025% FS)	10 mV
CC Mode Regulation	0-24 A	0-12 A	0-24 A	0-12 A	±(0.1%+0.1% FS)	1 mA
	0 – max Current				±(0.2%+0.15% FS)	10 mA
Current Measurement	0-24 A	0-12 A	0-24 A	0-12 A	±(0.1% + 0.1% FS)	1 mA
	0 – max. Current				±(0.2%+0.15% FS)	10 mA
Voltage Measurement	0 – 18 V				8522/8526: (0.02% + 0.02% FS)	1 mV
	0 - Vmax				8520/8524: (0.02% + 0.025% FS)	10 mV

All DC load models

common characteristics for all DC load models			
Parameter	Range	Accuracy	Resolution
CR Mode Regulation Input current ≥FS 10% Input Voltage≥FS 10%	0.1 -10 Ω	±(1%+0.3% FS)	0.001 Ω
	10-99 Ω	±(1%+0.3% FS)	0.01 Ω
	100-999 Ω	±(1%+0.3% FS)	0.1 Ω
	1K-4 KΩ	±(1%+0.8% FS)	1 Ω
CW Mode Regulation Input current ≥FS 10% Input Voltage≥FS 10%	0-100 W	±(1%+0.1% FS)	1 mW
	100 W – max Power	±(1%+0.1% FS)	100 mW
Power Measurement Input current ≥ FS 10% Input Voltage ≥ FS 10%	0-100 W	±(1%+0.1% FS)	1 mW
	100-max Power	±(1%+0.1% FS)	100 mW
Battery testing function	Input=0.1 V – 120 V Max measurement capacity= 999 A/H Resolution =10 mA Timer range=1~60000 sec		
Transition Mode	Range of Frequency 0.1 Hz-1 kHz Frequency error rate < 0.5%		

NOTE: Specifications and information are subject to change without notice. Please visit www.bkprecision.com for the most current product information.

Environmental Conditions

This instrument is intended for indoor use in a pollution degree 2 environment. Operating environmental limits are as follows:

Parameter	Specification
Humidity	≤ 95% relative humidity, non-condensing
Altitude	≤ 2000 m
AC Input	*220 ACV ± 10% , 47 ~ 63 Hz 110 ACV ± 10% , 47 ~ 63 Hz
Operating temperature	0 – 40 °C
Storage temperature	-10 – 60 °C

*For 220V operation on models 8524 and 8526, please order model 8524-220V and 8526-220V respectively.

Internal Resistances

The internal resistances of the DC load models are less than or equal to the following values:

Model	Internal Resistance(mΩ)
8500	≤ 35
8502	≤ 200
8510	≤ 15
8512	≤ 100
8514	≤ 8
8518	≤ 5
8520	≤ 45
8522	≤ 30
8524	≤ 6.5
8526	≤ 15

Operational power curve

The DC load's output follows a power curve illustrated below:

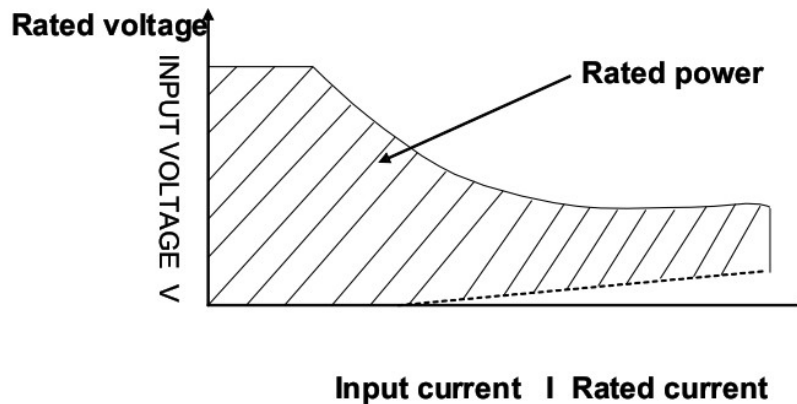

The curved portion is where the dissipated power is at the rated power of the instrument (and is actually a hyperbolic shape). When you use the menu to set lower-than-maximum power or current, the operating region may look like the following:

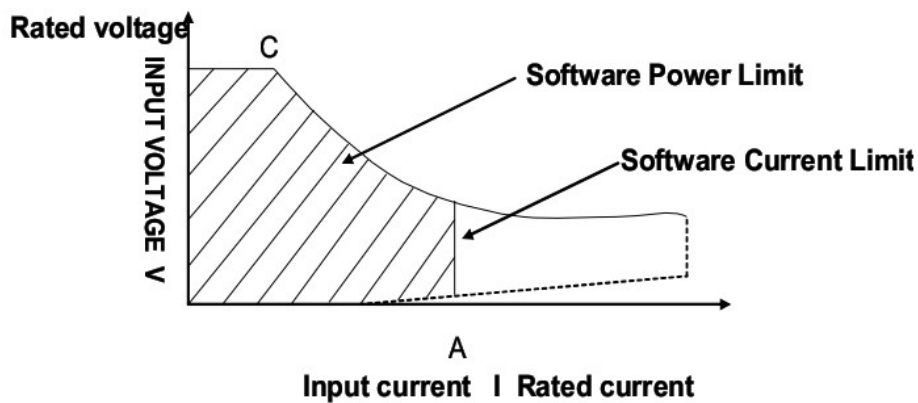

Note the gap between the operating region and the current axis for lower voltages. More detail is described in the following section.

Low Voltage Characteristics

The following graphs show the voltage/current relationships for low voltages:

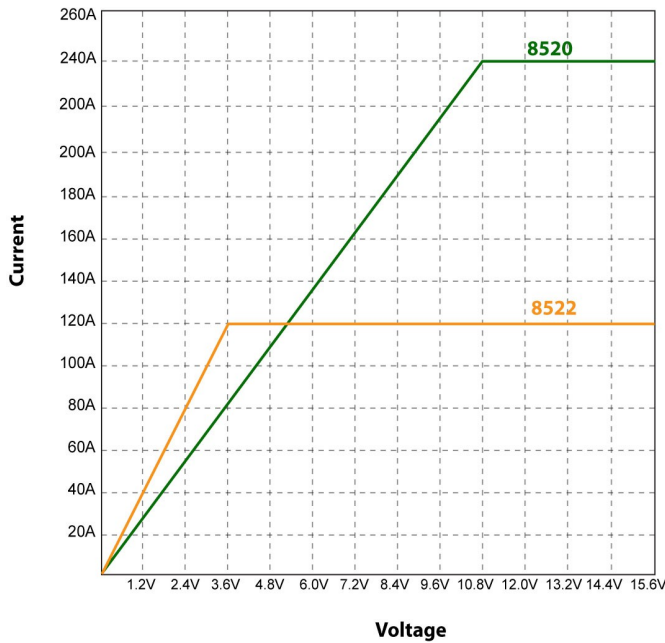
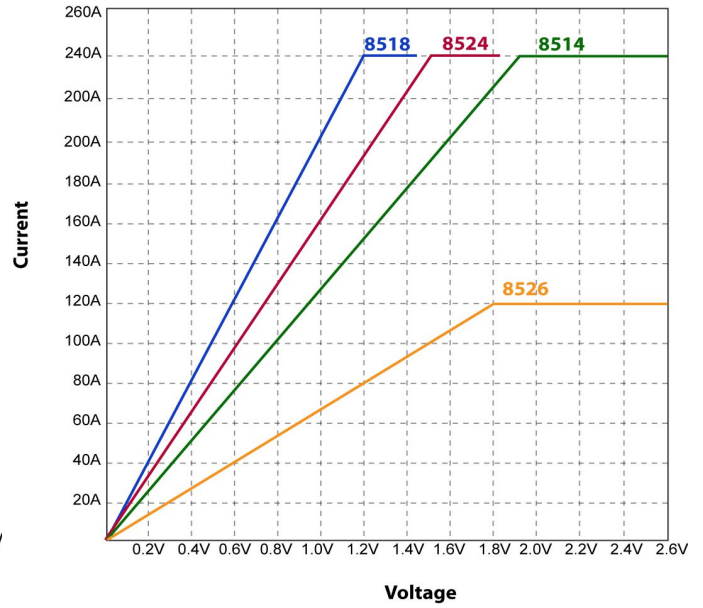
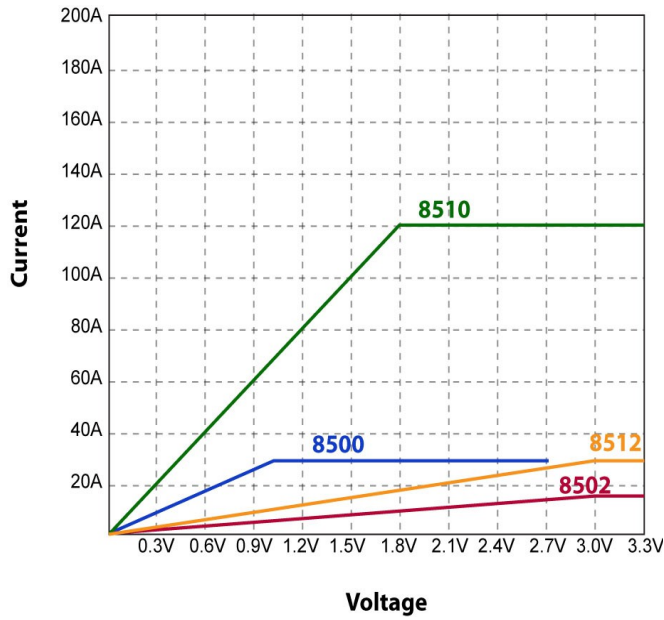

Slew rate

The slew rate for each DC load varies from model to model. The variations are also dependent on the different regions measured for each individual load. In general, the slew rate for low current transitions, say 0 to 0.5 A, is significantly lower than slew rate for current transitions from 30 to 70 A. The provided table below indicates measured slew rates based on the maximum range of current transition of the models are capable of. For example, model 8500's slew rate would be measured with current transition from 0 A to 30 A.

Note: The graph below illustrates slew rate measurements. In general, the indicated slew rates in the table below are measured based on the maximum current range each model is able to handle. Between the 10% and 90% region, the slew rate can be measured by observing the steepest slope portion. The indicated measured time would be used to calculate the slew rate. Hence, the slew rate calculation is simply $(\text{rated max. current} - 0 \text{ A}) / T$, where T is the measured time from 10% to 90% region and rated max. current is the specified maximum current of each load.

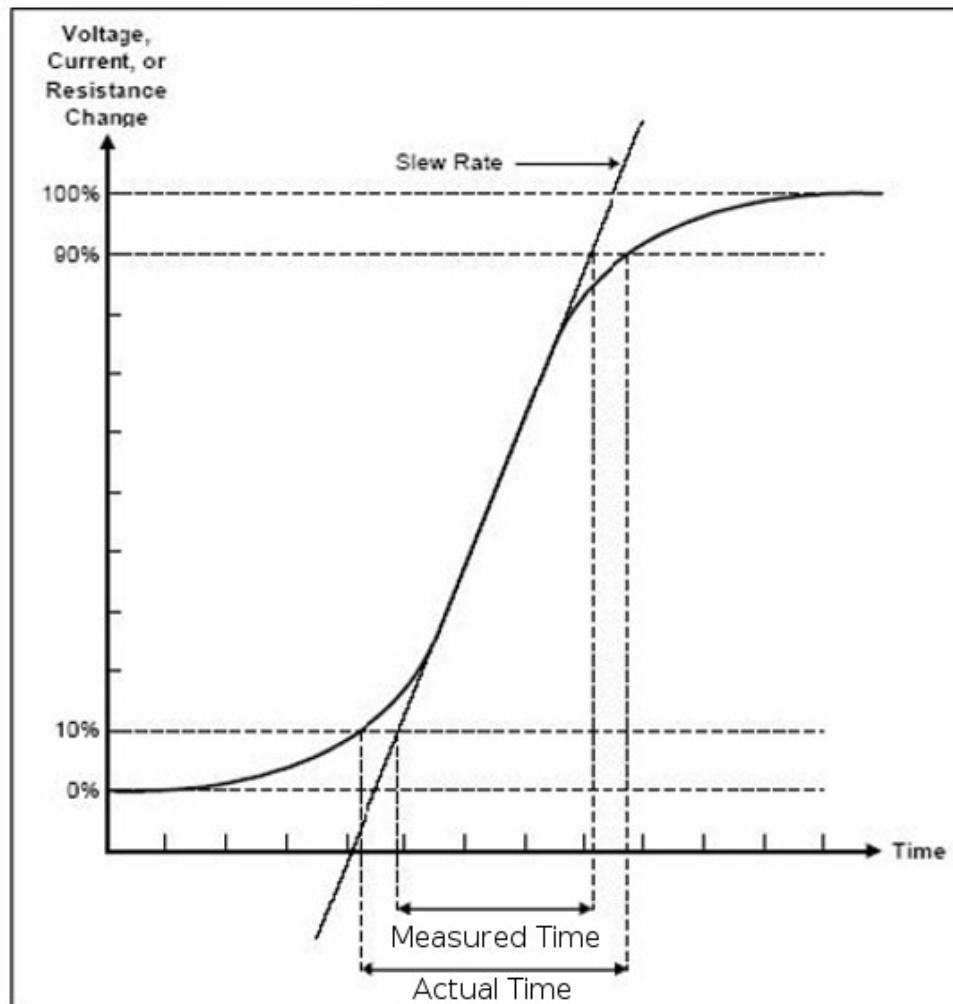

As a reference, below is a table of slew rates for their respective models:

Model	Slew rate
8500	$0.5A/\mu S$
8502	$0.5A/\mu S$
8510	$1A/\mu S$
8512	$0.5A/\mu S$
8514	$1A/\mu S$
8518	$1A/\mu S$
8520	$1A/\mu S$
8522	$1A/\mu S$
8524	$1A/\mu S$
8526	$1A/\mu S$

Glossary

△	Up arrow key. Used to scroll through the menu or cause the temporary display of the alternate standard display.
▽	Down arrow key. Used to scroll through the menu or cause the temporary display of the alternate standard display.
A	Value for first setting of transient mode.
B	Value for second setting of transient mode.
Battery	Select battery testing mode. See Battery test section.
CC	Constant current
Condition	Steady state, transient, or dynamic. Steady state condition means the load mode is operated in a steady state. Transient condition means the load mode is switched between two values with user-selectable timing. Dynamic means multiple levels and timings are available (and are gotten by using lists).
CR	Constant resistance
CV	Constant voltage
CW	Constant power
Dynamic condition	See Condition.
Enter	Choose the indicated value or setting.
Esc	Stop current entry and go to previous menu level.
I-set	Configure the instrument for constant current mode.
Knob click	Press the knob in until it clicks. This is an alternate method for changing settings.
Link	This annunciator will light up when communications are coming in across the serial interface. It will stay lit for approximately 3 seconds after the last command was received.
List	A list is a stored sequence of test parameter and test duration values. These are used for dynamic load profiles.
Local	Returns control to the front panel.
Menu	Show the top level item of the instrument's menus.
Mode	Mode of operation of the instrument. The four modes are CC, CV, CW, and CR.
Mode settings	Parameter values for CC, CV, CW, and CR modes.
On/Off	Manually toggle the instrument between its set mode and an infinite impedance state.
P-set	Configure the instrument for constant power mode.
Power	Power switch to turn the instrument on and off.

R-set	Configure the instrument for constant resistance mode.
Recall	Recall instrument state from non-volatile memory.
Remote sensing	Allows the instrument to measure the load power properly in case of large currents by sensing the voltage at the source, rather than at the instrument's terminals. This removes the effect of the resistance of long leads.
S-Tran	Set parameters (A, B, and transition times) for transient mode.
Shift	Shift key, which allows access to the functions written beneath the number keys.
Short	Toggles between normal operation and a low resistance short.
Store	Allows the user to save the instrument state in non-volatile memory.
Test file	A sequence of different test modes used for automated testing.
Tran	Set to transient condition.
Transient condition	See Condition.
Trigger	The key that causes an immediate trigger.
V-set	Configure the instrument for constant voltage mode.
VFD	Vacuum fluorescent display, the technology used for the instrument's display.

Installation

Inspection

Items you should have received

When you open the box containing the instrument, you should find the following items:

1. The DC Load instrument
2. Power cord
3. User manual
4. Installation CD with application software PV8500
5. TTL to USB converter
6. Calibration report

Instrument location

This instrument is intended for indoor use in a pollution degree 2 environment. Please refer to the specifications table for the allowable environment operating limits.

Significant power may be dissipated in the DC Load, which includes one or more thermostatically-operated fans. The fans draw air through the bottom and sides and exhaust it out the back. It is important to allow at least 25 mm (1 inch) of clearance on all sides of the instrument so adequate cooling airflow can be maintained.

CAUTION

Do not block the fan exhaust at the rear of the load.

Outline Drawings

All dimensions are in millimeters (mm).

Models: 8500& 8502

Dimension :214.5mmW x 88.2mm H x 254.6mm D

Terminal length: 29.4mm

Feet height:17.5mm

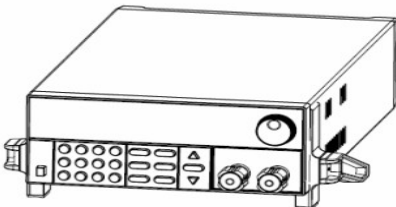
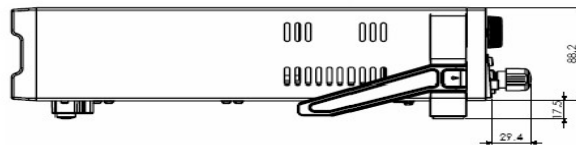
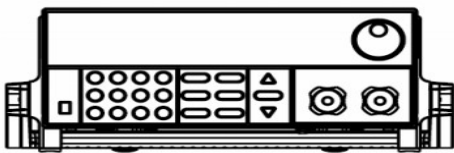

Outline Diagram Unit (mm)

Models 8510, 8512, 8514 & 8518

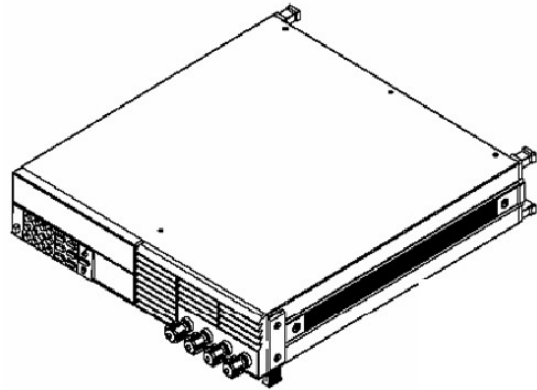
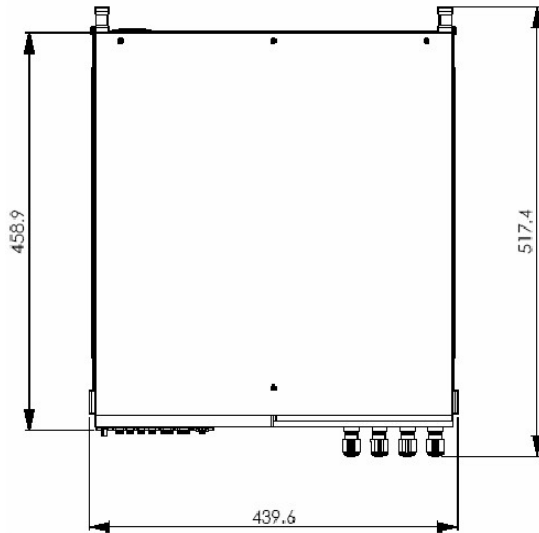
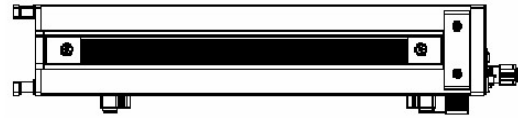
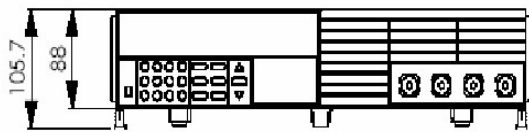

Outline Diagram Unit (mm)

Models 8520, 8522

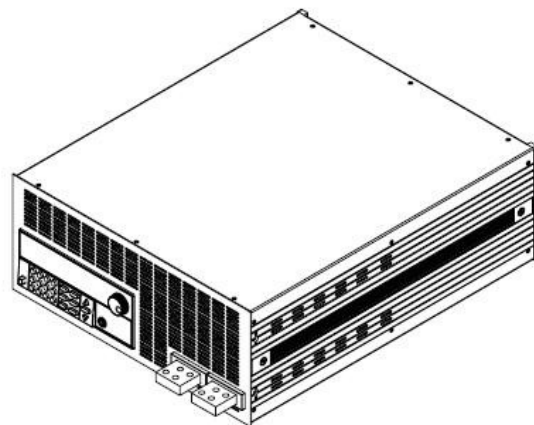
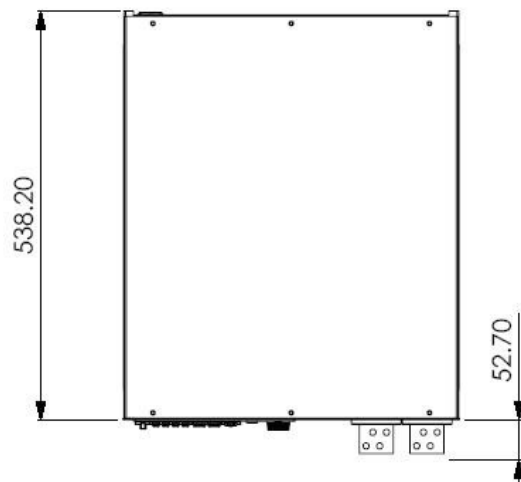
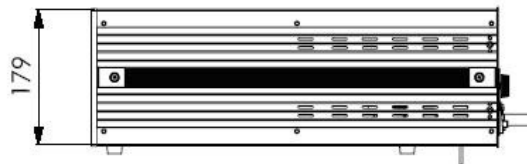
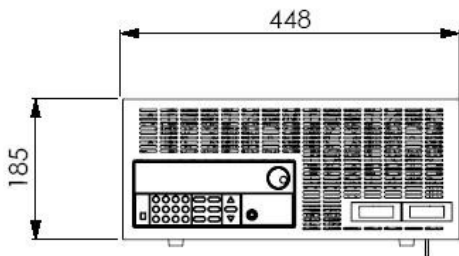

Models 8524 & 8526
Unit (mm)

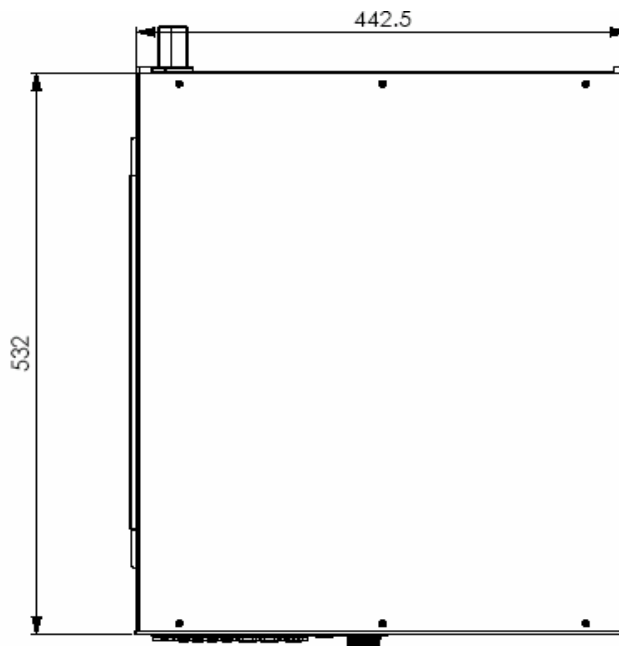
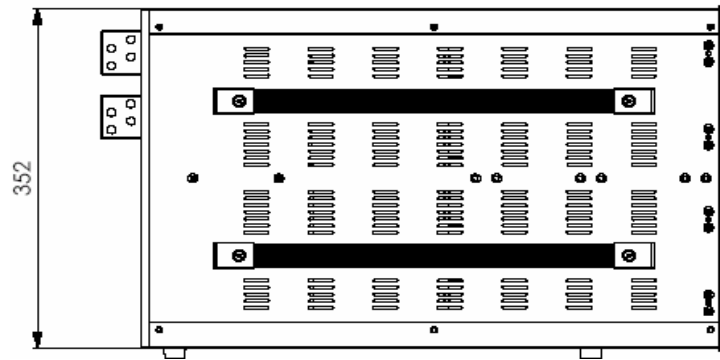
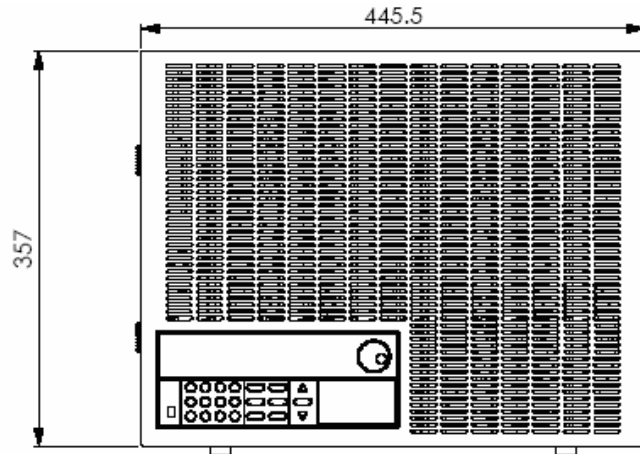

Model number	Dimensions in mm	Mass in kg
8500	215W×88H×359D	5.2
8502	215W×88H×359D	5.2
8510	439.6W×88H×459D	14
8512	439.6W×88H×459D	14
8514	439.6W×88H×459D	14
8518	439.6W×88H×459D	14
8520	448W×185H×538.2D	30
8522	448W×185H×538.2D	30
8524	445.5W×357H×532D	67
8526	445.5W×357H×532D	67

Bench operation

The 8500 DC Load is provided with a carrying handle. The following pictures demonstrate various ways to use the handle.

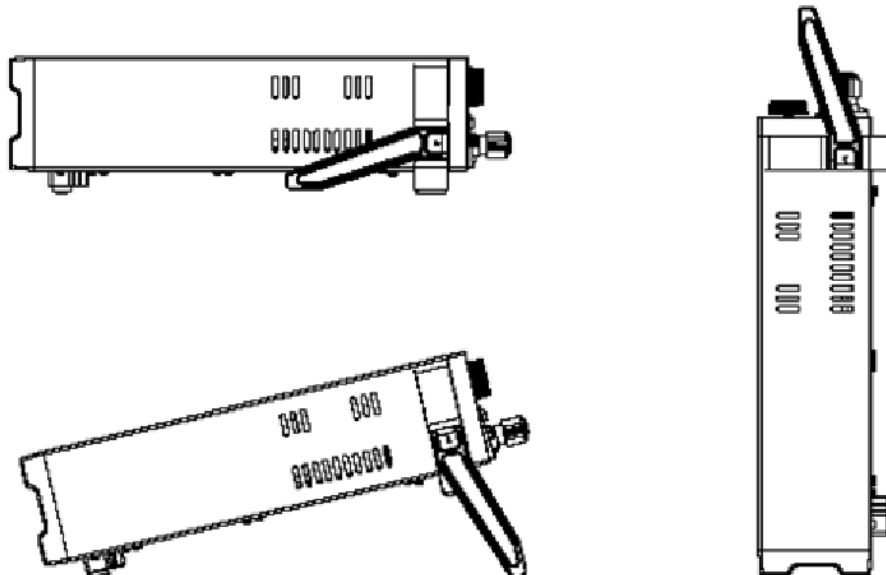

The handle may be removed if desired. A rack mounting kit (IT-E151) is also available for models 8500, 8502, 8510, 8512, 8514, and 8518.

First turn-on checkout

Ensure that the line voltage selector switch on the back panel is set to match your line voltage. Failure to do so could result in damage to the instrument.

CAUTION

Note: For models 8524 and 8526, the line voltage switch is not usable and does not allow for 220VAC operation. Do not connect them directly into a 220V line. For 220V operation, please order model 8524-220V or 8526-220V.

Connect an appropriate IEC power cord to the DC Load and plug the power cord into an AC power outlet. Ensure that nothing is connected to the INPUT terminals. Turn the instrument on by pushing the Power button in. The instrument should display **SYSTEM SELFTEST**, then display **0.00V 0.000A**. A small annunciator will display **OFF** in the upper left corner of the display. If you do not see this display, please consult the *In case of trouble* chapter.

The following test will verify the DC Load can operate properly in constant current mode. Press the **I-set** button (you may have to press it twice) and use the numeric keypad to set the current to 0.1 A. To do this, press **.** (the decimal point), **1**, **Enter**. Alternatively, you can adjust the current level with the knob, then click the knob or press **Enter**.

Connect a power supply or battery to the DC Load, observing the polarity. Turn the power supply on and set a voltage of 1 volt. On the DC Load, press the **On/Off** button. You should see approximately 0.1 A of current flowing as shown by the instrument's ammeter and approximately 1 volt. The **CC** annunciator should be displayed, showing that the instrument is in the constant current mode.



The instrument's voltage display may read a bit less than the power supply's output -- this may be due to a voltage drop in the wires connecting the power supply to the DC Load. Press the Δ or ∇ keys to see the power that is being consumed by the load.



Press the **V-set** button (you may have to press it twice). Note the load is turned off. Set the power supply to 10V and the supply's current to a very low level, e.g. 0.1 A. Set the DC Load voltage level well below the supply voltage level, e.g. 1 V. Press the **On/Off** key. Verify the proper voltage level (1 V) is shown on the display. Press the Δ or ∇ keys to see the power being dissipated.

Press the **P-set** button (you may have to press it twice). Note the load is turned off. Set the power level to 0.1 watt. Press the **On/Off** key. Press the Δ or ∇ keys to verify that the power is about 0.1 watt.

Press the **R-set** button (you may have to press it twice). Set the resistance to 100 Ω . Press the **On/Off** key. Verify that the current is approximately the displayed voltage in V divided by 100.

You can cycle between the four modes by pressing the **I-set**, **V-set**, **P-set**, and **R-set** buttons. Note that the previously-set values are remembered.

If the instrument worked as explained above, you've demonstrated that the four operating modes of the instrument are working. Please refer to the next section for detailed operation instructions.

Operational introduction

There are four operational modes of the instrument: constant current, constant voltage, constant power, and constant resistance (we will abbreviate these as CC, CV, CW, and CR, respectively). These are selected by the **I-set**, **V-set**, **P-set**, and **R-set** buttons, respectively. If you press a mode button different than the currently set mode, the load will be set to **OFF** and the newly selected mode's setting will be displayed for about 3 seconds. Pressing the same mode button again will prompt for the new constant value for the selected mode.

There are three operational conditions for the instrument in these modes: steady state, transient, and dynamic.

Condition	Behavior
Steady state	The selected mode parameter is maintained at a constant value. For example, if you selected constant current mode and set the current value to 1 A, the instrument would maintain this current indefinitely when the load is ON .
Transient	There are two mode parameters and the load switches between these two settings with user-specified timing. An example of a transient load in constant resistance mode would be a load of 10 Ω for 1 second and 20 Ω for 3 seconds.
Dynamic	Similar to the transient condition, but capable of emulating more complex time-dependent loads. The dynamic condition uses lists to specify the time-dependent behavior.

Examples of the three conditions of operation are illustrated in the following diagram:

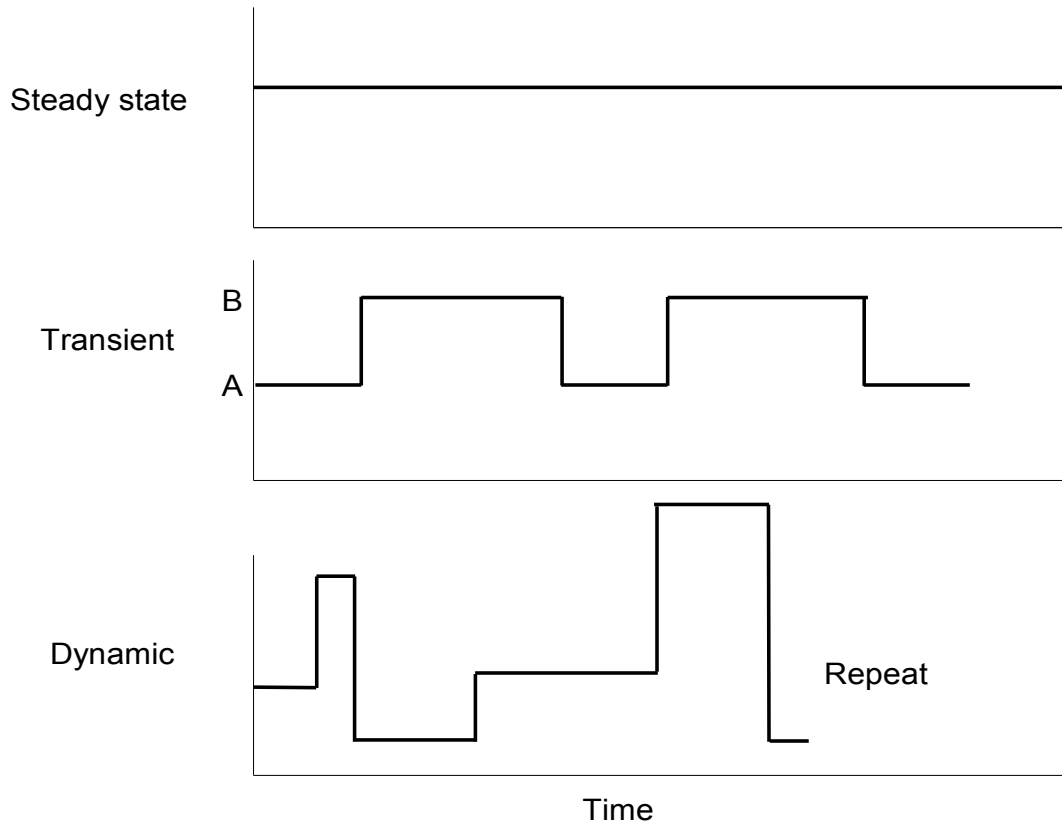

Power-on state

The default power-on instrument state is to not remember the instrument mode settings before the last power-down. If you wish to have the mode settings remembered across a power-down, power-up cycle, use the following keystrokes:

Key	Display
Shift + Menu	:CONFIG
Enter	:INITIAL CONFIG
▽	:INPUT RECALL
▽	:POWER-ON RECALL
Enter	:OFF <DEFAULT>
▽	:ON
Enter	:POWER-ON RECALL
Esc	:CONFIG

Key	Display
Esc	Standard voltage/current display

Constant current mode

In constant current mode, the DC load will sink a constant current, regardless of the voltage at its terminals. To set up the DC Load to operate in constant current mode and in the steady state condition, use the following keystrokes:

Key	Display
I-set	If you press this key after powering up and there is no currently-stored constant current value, you'll be prompted for the desired current level. If there was a current value already stored, it will be momentarily displayed and the instrument will be in CC mode. If you wish to change the current setting, press I-set again. The OFF annunciator will be displayed.
On/Off	Turns the constant current load on. The CC annunciator will be on.
Δ or ▾	Momentarily display the power level and the set current value.
On/Off	Turns the load off.

To operate the DC Load in CC mode in a transient condition, see the **Transient operation** section. To operate the DC Load in CC mode in a dynamic condition, see the **Lists** section.

Constant voltage mode

In constant voltage mode, the DC load will cause a constant voltage to appear at its terminals. To set up the DC Load to operate in constant voltage mode and in the steady state condition, use the following keystrokes:

Key	Display
V-set	If you press this key after powering up and there is no currently-stored constant voltage value, you'll be prompted for the desired voltage level. If there was a voltage value already stored, it will be momentarily displayed and the instrument will be in CV mode. If you wish to change the voltage setting, press V-set again. The OFF annunciator will be displayed.
On/Off	Turns the constant voltage load on. The CV annunciator will be on.
Δ or ▾	Momentarily display the power level and the set voltage value.
On/Off	Turns the load off.

To operate the DC Load in CV mode in a transient condition, see the **Transient operation** section. To operate the DC Load in CV mode in a dynamic condition, see the **Lists** section.

Constant power mode

In constant power mode, the DC load will cause a constant power to be dissipated in the load. To set up the DC Load to operate in constant power mode and in the steady state condition, use the following keystrokes:

Key	Display
P-set	If you press this key after powering up and there is no currently-stored constant power value, you'll be prompted for the desired power level. If there was a power value already stored, it will be momentarily displayed and the instrument will be in CW mode. If you wish to change the power setting, press P-set again. The OFF annunciator will be displayed.
On/Off	Turns the constant power load on. The CW annunciator will be on.
△ or ▽	Momentarily display the power level and the set power value.
On/Off	Turns the load off.

To operate the DC Load in CW mode in a transient condition, see the *Transient operation* section. To operate the DC Load in CW mode in a dynamic condition, see the *Lists* section.

Constant resistance mode

In constant resistance mode, the DC load will behave as a fixed resistance value. To set up the DC Load to operate in constant resistance mode and in the steady state condition, use the following keystrokes:

Key	Display
R-set	If you press this key after powering up and there is no currently-stored constant resistance value, you'll be prompted for the desired resistance. If there was a resistance value already stored, it will be momentarily displayed and the instrument will be in CR mode. If you wish to change the resistance setting, press R-set again. The OFF annunciator will be displayed.
On/Off	Turns the constant resistance load on. The CR annunciator will be on.
△ or ▽	Momentarily display the power level and the set resistance value.
On/Off	Turns the load off.

To operate the DC Load in CR mode in a transient condition, see the *Transient operation* section. To operate the DC Load in CR mode in a dynamic condition, see the *Lists* section.

Timed operation

The DC Load can be set to allow timed operation. When you turn the load on, it stays on for the specified time, then turns itself off.

To set up timed operation, use the following keystrokes:

Key	Display
Shift + Menu	:CONFIG
Δ Δ	:LOAD ON TIMER
Enter	:TIMER STATE
Enter	Use arrow keys to set to :ON .
▽	:TIMER SET
Enter	TIMER=XXXXXS Enter desired time interval. Valid values are 1 to 60000 seconds (1000 minutes).
Enter	:TIMER SET
Esc Esc	Standard display

Now, when you turn a load on, it will stay on for the designated time, then turn off.

To turn off timed operation, enter the menu **:CONFIG:LOAD ON TIMER:TIMER STATE** and set it to **:OFF**.

Changing display resolution

The DC Load has two ranges of current and voltage (see the specifications). You can enable higher resolution for voltages and currents on the lower range. Enter the menu with **Shift + Menu** and set the menu element **:CONFIG:RANGE SELECT** to **ON**.

Increasing current resolution

To increase the current resolution (and change to the lower range), press **Shift + ▽**. If the DC Load is sinking a current higher than the top end of the lower range, it will be reset to the top end of the lower range. To change back to the lower current resolution, press **Shift + ▽** again.

Increasing voltage resolution

To increase the voltage resolution (and change to the lower range), press **Shift + Δ**. You may see **OVERVOLTAGE** message on the display if the voltage is too high. To change back to the lower voltage resolution, press **Shift + Δ** again.

Short

When a test mode is on, you may press **Shift + Short** to emulate a short. This will draw maximum current from the DC supply in any of the four operation modes (CC, CV, CW, or CR). In CC, CV, or CR mode, you may press **Shift + Short** to stop the short. The DC Load will return to its previous operation. However, in CW mode, the short current will continue to be drawn; to stop the short, you must press the **On/Off** key

Note: When emulating a Short while in CV mode, the current software limit may trigger the DC load Input to turn Off, provided the current limit is reached. This does not affect the programmed settings and the DC load will restore the previously programmed values once the Short condition is removed.

Battery test

The battery test feature measures the time it takes for a battery voltage to drop to a specified value while drawing a constant current from the battery. When the voltage at the DC Load's terminals reaches the specified voltage, the test is ended and the integrated current (i.e., charge supplied by the battery) in ampere*hours (A*hrs) of the battery is calculated and displayed. To run a battery test, follow these steps:

Key presses	Display
I-set , enter current value with numerical keys, then press Enter .	Set the DC Load to constant current mode and set the current you want to draw from the battery. (You may have to press the I-set key twice to be able to set the current value.)
Shift + Battery	MIN VOLT= 0.10V This indicates you're being asked for the voltage level where the battery test will be over.
Enter voltage level and press Enter .	When you press Enter, the test will start. The CC annunciator will be on.
Δ or ∇	Shows the power level and the ampere*hours (A*hrs) accumulated so far.
When the battery voltage drops below the specified value, the test will turn off and you will see the OFF annunciator.	
Δ or ∇	Display the total charge delivered by the battery in ampere*hours (A*hrs).
Shift + Battery	Turns battery testing mode off.

NOTE: you must make sure that you press **Shift + Battery** at the end of the test. Otherwise, the instrument will not respond to any key presses except Δ or ∇ .

Transient operation

The transient condition allows switching between two different load values. There are three different types of transient operation.

Continuous transient operation

In continuous transient operation, the load is continuously switched between two load values. An example is shown in the following figure:

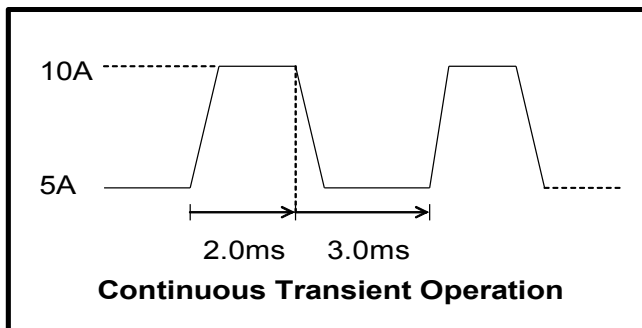

Note that this transient behavior works with any of the operation modes CC, CV, CW, or CR. Here are the keystrokes used to setup this continuous transient condition:

Keys	Display
I-set	Standard display of voltage and current (or, you'll be asked to enter a current value).
Shift + S-Tran	LEVEL A= X.XXXA You are being prompted for the first current value. Press the 5 key for 5 A.
Enter	Enters the 5 A value, then displays WIDTH A = X.XMS . You're being prompted for the duration of the 5 A load -- press the 3 key for 3 ms.
Enter	Enters the 3 ms value, then displays LEVEL B= X.XXXA . You are being prompted for the second current value. Press the 1 and 0 keys to enter 10 A.
Enter	Enters the 10 A value, then displays WIDTH B = X.XMS . You're being prompted for the duration of the 10 A load -- press the 2 key for 2 ms.
Enter	Enters the 2 ms duration, then displays :CONTINUOUS , :PULSE , or :TOGGLED . Use the ▲ or ▼ arrow keys to display :CONTINUOUS .
Enter	Returns to the standard display of voltage and current.

To activate this continuous transient condition, press **Shift + Tran**, then press **On/Off**. The load will begin switching between the two Tran values with the timing you entered.

Pulse transient operation

In pulse transient operation, the load operates at the A value that has been entered until a trigger is received. At the trigger, the load switches to the B value and stays at that level for the B timing value. Then the load switches back to the A value and stays there until another trigger is received. Here's an example:

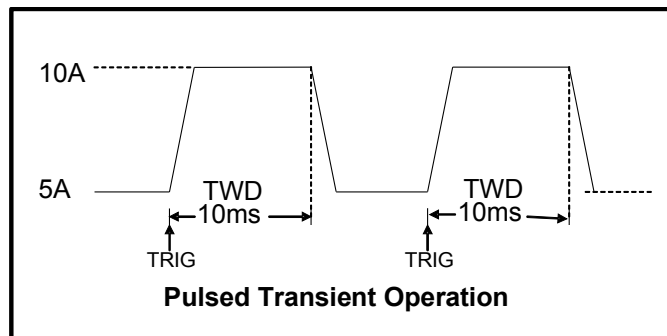

Here are the keystrokes needed to set up this example:

Keys	Display
I-set	Standard display of voltage and current (or, you'll be asked to enter a current value).
Shift + S-Tran	LEVEL A= X.XXXA You are being prompted for the first current value. Press the 5 key for 5 A.
Enter	Enters the 5 A value, then displays WIDTH A = X.XMS . You're being prompted for the duration of the 5 A load. In the pulse mode of operation,

Keys	Display
	this width is ignored, so enter any convenient value.
Enter	Displays LEVEL B= X.XXXA . You are being prompted for the second current value. Press the 1 and 0 keys to enter 10 A.
Enter	Enters the 10 A value, then displays WIDTH B = X.XMS . You're being prompted for the duration of the 10 A load -- press the 1 and 0 key for 10 ms.
Enter	Enters the 10 ms duration, then displays :CONTINUOUS , :PULSE , or :TOGGLED . Use the Δ or ∇ arrow keys to display :PULSE .
Enter	Returns to the standard display of voltage and current.

To activate this pulse transient condition, press **Shift + Tran**, then press **On/Off**. The load will start at the A level of current you entered (5 A). Press **Shift + Trigger** to cause the load to switch to the B level of current (10 A). The 10 A current will last for the designated 10 ms, then switch back to the A level (5 A).

NOTE: This example requires the **:CONFIG:TRIGGER** menu item be set to **:IMMEDIATE**. If set to **:EXTERNAL**, you'd trigger the instrument with a high TTL level signal on the trigger terminals on the rear panel. If set to **:BUS**, you'd trigger the instrument with a software trigger.

Toggled transient operation

In toggled transient operation, the load starts at the stored parameter for the mode. When a trigger is received, the load switches to the B value. When another trigger is received, the load switches to the A value. It stays at the A value until another trigger is received, at which point it switches to the B value. Further triggers cause the load to switch between the A and B values. Here's an example:

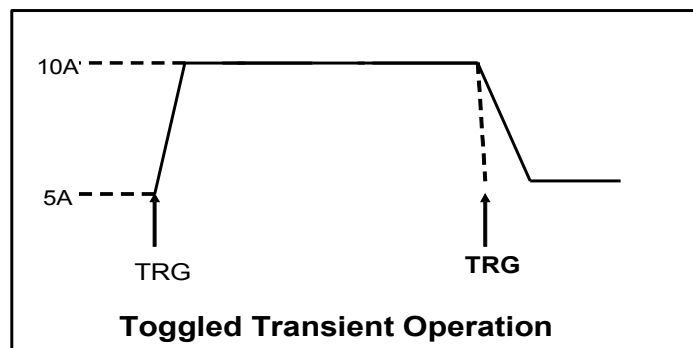

Here are the keystrokes needed to setup this example:

Keys	Display
I-set	Standard display of voltage and current. Enter a value of 5 A (you may need to press the I-set key again). Press Enter.
Enter	Enters the CC mode's value. The standard display is shown.
Shift + S-Tran	LEVEL A= X.XXXA You are being prompted for the first current value. Press the 5 key for 5 A.
Enter	Enters the 5 A value, then displays WIDTH A = X.XMS . You're being

Keys	Display
	prompted for the duration of the 5 A load. In the toggled mode of operation, this width is ignored, so enter any convenient value.
Enter	Displays LEVEL B= X.XXXA . You are being prompted for the second current value. Press the 1 and 0 keys to enter 10 A.
Enter	Enters the 10 A value, then displays WIDTH B = X.XMS . You're being prompted for the duration of the 10 A load. . In the toggled mode of operation, this width is ignored, so enter any convenient value
Enter	Displays :CONTINUOUS , :PULSE , or :TOGGLED . Use the ▲ or ▼ arrow keys to display :TOGGLED .
Enter	Returns to the standard display of voltage and current.

To activate this toggled transient condition, press **Shift + Tran**, then press **On/Off**. The load will start at the value you entered for A (5 A). Then press **Shift + Trigger** to cause the load to switch to the B level of current (10 A). The next trigger will cause the load to shift back to the A level (5 A). Subsequent triggers repeat this behavior.

NOTE: This example requires the **:CONFIG:TRIGGER** menu item be set to **:IMMEDIATE**. If set to **:EXTERNAL**, you'd trigger the instrument with a high TTL level signal on the trigger terminals on the rear panel. If set to **:BUS**, you'd trigger the instrument with a software trigger.

Toggle between two test values

When you have entered A and B values through the **Shift + S-Tran** menu, those values are available to you at the front panel. Suppose you set the instrument to operate in CC mode at a current of 1 A. If the transient A level was 5 A and the transient B level was 10 A, you can set the instrument to the A level by pressing **Shift + A**. The load has to be on and cannot be in transient condition (i.e., the **TRAN** annunciator must not be lit). Otherwise, the A value will be stored as the CC mode's current. Similarly, **Shift + B** causes the B value to be stored as the CC mode's current. The load can be on or off for this to work.

Lists (dynamic condition)

Transient operation is used for simple step changes in load values. More complicated dynamic behavior of the load can be obtained through the use of lists. Lists are a sequence of load value and duration pairs. Lists are the logical extension of transient operation.

Note: Resolution of the step values defined in list mode varies depending on the mode of operation. In CW, CR, and CV list mode, resolution defined for each list step is maximum at 10 mW, 10 mΩ, and 10 mV respectively. For example, a CW list step can be configured as 10.23 W. For CC list mode, maximum resolution is 1 mA for the step values. For example, a CC list step can be configured as 1.234 A.

To illustrate the use of a list, we'll create a list that runs the following constant current profile on a power supply:

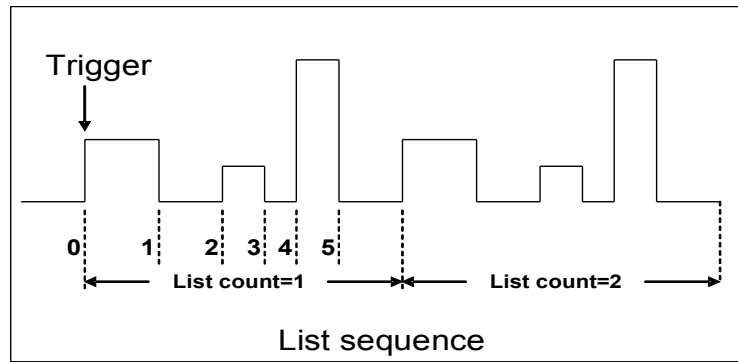

This list is characterized by the following current/duration pairs

Current, A	Duration, ms	Between times
3	1000	0 and 1
0	800	1 and 2
2	500	2 and 3
0	300	3 and 4
6	500	4 and 5

This list has 5 steps, located at the transitions 1 through 5. The first duration, 1000 ms, occurs after the triggered event. Subsequent durations are from the previous transition to the current transition.

Here are the keystrokes to set up this list:

Keys	Display
Shift + Menu	:CONFIG
▼ ▼	:LIST SET
Enter	:MODE SET
Enter	Select :LIST mode. This will cause the LIST annunciator to turn on.
Enter	:MODE SET
▼ ▼	:EDIT LIST FILE
Enter	:CURRENT LIST
Enter	Select :REPEAT .
Enter	LIST COUNT= N How many steps this list has. Enter the number 5.
5 Enter	COUNT 1= X.XXA Set the current for the first step. Enter 3.
3 Enter	COUNT 1= X.XXMS Set the duration for the first step. Enter 1000.
1000 Enter	Repeat the current and duration entry for the following 4 steps.
Enter	STORE LIST FILE 1 The 1 is underlined, indicating you can enter a number to specify the "file" (i.e., block of EEPROM) to store this list to. Choose a number via the keypad or the knob. You can choose any number between 1-8.
Enter	:EDIT LIST FILE

Keys	Display
Esc Esc	Standard display

First, press the **On/Off** key. The load will sink the current that is stored as the CC mode parameter (set it to 0 A if you don't want an initial current). Then press Shift + Trigger to have the list start executing.

Should you wish to have the list only execute once after the trigger, you can edit the list to use **:ONCE** instead of **:REPEAT**.

To exit List mode press the **Shift** and **Trigger** key

Test files

Test files are a generalization of lists -- they let you generate a sequence of tests using different modes, mode parameters, and durations. They are useful for executing a set of tests on a device, then displaying whether the tests passed or failed. We will illustrate how to use test files by a short example.

Suppose we have a small AC to DC power supply (a "wall-wart") and we want to set up an acceptance test for a number of these devices. Our test will consist of two steps:

1. Set the DC load to constant current mode to draw the rated current of 0.35 A from the device. The output voltage of the device at the rated current must be between 4.4 volts and 4.6 volts.
2. When the device operates into a short, the supplied current must be larger than 2.0 A.

Keys	Display
Shift + Menu	:CONFIG
▽ ▽	:LIST SET
Enter	:MODE SET
▽ ▽ ▽ ▽	:EDIT TEST FILE
Enter	MAX CURR= 3.000A Set the maximum current to 2.5 A
2.5 Enter	MAX VOLT= 18.00V Set the maximum voltage to 5 V
5 Enter	MAX POWER= 150.00W Set the maximum power to 15 W
15 Enter	TEST COUNT= 6 Our test will consist of two steps, so we enter 2. You can enter up to 20 steps.
2 Enter	CONST CURRENT Since our first test is in constant current mode, we'll just press Enter to select this mode.
Enter	SET 1= 0.210A This is the prompt for the constant current value. We set it to 0.35 A.
.35 Enter	SHORT OFF We can turn a short on or off at this step. Here, we want short off, so we just press Enter.
Enter	READBACK V We're being prompted for what parameter to read back and check. We want voltage, so we press Enter.

Keys	Display
Enter	MIN 1= 5.80V We want the minimum voltage read back to be at least 4.4 V.
4.4 Enter	MAX 1= 6.15V The maximum value we'll allow is 4.6 V.
4.6 Enter	DELAY 1= 1.0<S> This delay time is how long to wait before making the readback measurement. If you set it to 25.5 seconds, the test will halt at this point, requiring you to press Shift + Trigger to continue the test. We'll use 1 second.
1 Enter	CONST CURRENT We're being prompted for the mode to use for the next step. We'll again use constant current, so we'll press Enter (this step will also be a short, so the mode doesn't really matter).
Enter	SET 2= 5.000A We'll set the current to 2.5 A, which is the maximum current we've allowed for this test..
2.5 Enter	SHORT OFF We select short on and then press Enter.
▽ Enter	READBACK A We want to readback the current, so we press Enter.
Enter	MIN 2= 4.950A Our minimum value is 2.0 A.
2 Enter	MAX 2= 5.050A We choose 2.5 A as the maximum value.
2.5 Enter	DELAY 2= 3.0<S> We'll wait 2 seconds for the maximum current.
2 Enter	STORE TEST FILE1 The 1 is underlined, meaning you can choose which test file number to store this test to. You can choose any number between 1-8. Here, we will use 1, so just press Enter.
Enter	EDIT TEST FILE
Esc Esc	Exit the menu. The normal display is shown (V and A).

The test file has been created and saved in file position 1. Now we will run the test on the device.

Keys	Display
Shift + Menu	:CONFIG
▽ ▽	:LIST SET
Enter	:MODE SET
▽ ▽ ▽	:CALL TEST FILE
Enter	RECALL 1 We're being prompted for which file number to recall. Since we saved to file number 1, we just press Enter.
Enter	CALL TEST FILE The test file is now loaded, so we return to the normal display.
Esc Esc	Exit the menu. The normal display is show (V and A).
Shift I-set	NAME:TEST FILE 1 We've entered automatic testing mode. The display is showing which test file we're using.
Shift Trigger	This starts the test. You'll see the values sequentially displayed. Then you'll either see PASS or FAULT . You can press Shift Trigger again for

Keys	Display
	another test run or press Esc to return to the normal display.
Esc	Return to the normal display.

Triggering

Triggering is used with the transient and dynamic conditions to allow synchronization of the DC Load's behavior with other events. There are three types of triggers you may use (set in the **CONFIG:TRIGGER SOURCE** menu):

Trigger Type	Explanation
IMMEDIATE	An immediate trigger is created by pressing Shift + Trigger on the front panel keys.
EXTERNAL	An external trigger is a TTL high signal applied to the Trigger connection on the back panel. This TTL signal must last for more than 5 ms. A trigger applied to this input can be used to change settings (voltage, current, resistance), toggle between settings in transient-toggle mode, or generate a pulse in pulse mode.
BUS	The instrument will be triggered if a 5AH command is sent via the USB (Virtual COM) interface. See the Remote operation section for more details.

Voltage threshold operation

The DC Load can be set to only turn on if the voltage is at or above a set value. Additionally, the load will turn off if the voltage drops below a second set value. This feature works for any mode.

Note: Voltage threshold operation has a minimum time requirement of 500 ms for it to detect the set conditions and respond accordingly. Therefore, when operating in modes (i.e. transient mode, list mode) in which timing between load changes can be set to < 500 ms, this operation will not function.

An example of use would be to ensure an electronic system under test will not have power applied unless the supply voltage is above a certain value. The DC Load would be put in series with the power supply. Remote sensing would be turned on and the remote sensing connector on the back would be used to connect to the power supply's output voltage.

Use the menu items **SYSTEM SET:VOLTAGE ON SET** and **SYSTEM SET:VOLTAGE OFF SET** to set the on and off voltage thresholds, respectively.

Example 1: set the **VOLTAGE ON SET** and **SYSTEM SET:VOLTAGE OFF SET** both to 1.0 V. Set the instrument to constant current mode with the **I-set** key and set the current level to 0.1 A. Turn the load on by pressing the **On/Off** key. When power is applied to the DC Load, the voltage must rise above 1.0 V before the load draws current from the source. If the voltage drops below 1.0 V on the load's terminals, the load will stop drawing current from the source.

Example 2: Same as the previous example, except set the **VOLTAGE ON SET** to 1.0 V and the **SYSTEM SET:VOLTAGE OFF SET** 0.0 V. As before, the load will turn on only when the voltage exceeds 1.0 V, but once it is "triggered" on, it will now stay on, even if the voltage drops to zero.

Passwords

If you enter the menu **CONFIG:KEY LOCK SET**, you can set a one to four digit password. This password will be required when changing settings from the front panel. The only operations allowed without entering the password are:

Shift + A
Shift + B
Shift + Short
Shift + Tran
Shift + Trigger
On/Off

To remove the password, enter the menu **CONFIG:KEY LOCK SET** and do not press any number keys, then press **Enter**.

Protection features

To protect external hardware when using the DC Load, you can set the maximum allowed values for current, voltage, and power. These settings will override any settings subsequently made from the front panel using the **I-set**, **V-set**, **P-set**, or **R-set** keys.

To set these protection values, use the following keystrokes:

Keys	Display
Shift + Menu	:CONFIG
▽	:SYSTEM SET
Enter	Select between: :MAX CURRENT SET :MAX POWER SET :MAX VOLTAGE SET using the △ and ▽ arrow keys, then press Enter . Enter the desired value, then press Enter to accept it.
Esc Esc	Exit from the menu.

Example: Suppose you are measuring current vs. voltage characteristics of a 1 watt resistor. You could set the maximum allowed power to 1.1 watts to test the resistor's rating, yet not go over the maximum rating by more than 10% to ensure you don't destroy the resistor. If you tried to use the **P-set** key to set the power to more than 1.1 W, the instrument will limit the set value to 1.1 W.

Over Voltage protection

If input voltage exceeds the voltage limit set by the user, the **DC load** will turn the input OFF and the buzzer will sound. The display will show **OVER VOLTAGE**. The maximum voltage limit value is equal to the maximum rated voltage for each model. For the over voltage protection state to be activated, the voltage level presented to the load terminal must exceed the limit set value by approximately 5%.

Over Current protection

When operating in CR, CC or CW mode, the load current will be limited by a current limit value set by the user. The maximum current limit value is equal to the maximum rated current for each model.

Once the maximum current limit is reached, the DC Load will enter the over current protection state and the current will be limited to the set value. (The input will not turn off). If the DC load previously operated CR or CW mode, the DC load will automatically revert to CC mode and the VFD display will indicate CC. When the DC load operates in a combined CV / transition mode or CV / List mode, the buzzer will sound if the input current exceeds the current limit and the display will show a flashing current value.

Over Power protection

If the input power exceeds the power limit in the normal operation mode, the DC load will enter the over power protection state. The display will show CW.

If the input power exceeds the limit when in transition mode or list mode, the buzzer will sound and the display will flash the current value and voltage value.

Reverse voltage protection

This feature protects the load module in case the DC input terminals are connected to a power source with reversed polarity. If a reverse voltage condition is detected, the buzzer will sound and **REVERSE VOLTAGE** will be displayed on screen.

Over Temperature protection

If internal temperature exceeds safety limits (80°C, 176°F), the Over temperature circuitry will be activated. The DC Load will turn off the input, the buzzer will sound, and the display will show **OVERHEAT**.

Remote sensing

Remote sensing is used to counteract the effect of lead resistance. For example, if you connect a power supply to the DC Load, the voltage at the power supply's terminals will not be the same as the voltage at the DC Load's terminals if there is a current flowing because of the finite resistance from the wires. Using remote sensing, you can sense the voltage at the power supply's terminals, effectively removing the effect of the voltage drop in the connection wire.

When using remote sensing, the power displayed by the instrument includes both the power dissipated inside the instrument and the power dissipated in the leads from the power supply to the DC Load's input terminals.

To turn remote sensing on:

Keys	Display
Shift + Menu	:CONFIG
Enter	:INITIAL CONFIG
▼ 8 times	:REMOTE SENSE
Enter	:OFF DEFAULT
▼	:ON
Enter	:REMOTE SENSE and annunciator shows Sense .
Esc Esc	Exit from the menu.

The following diagram shows the remote sensing terminals on the back of the instrument:

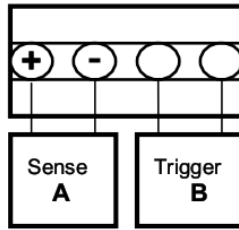

The following shows a wiring diagram for remote sensing:

Wiring diagram for remote sense

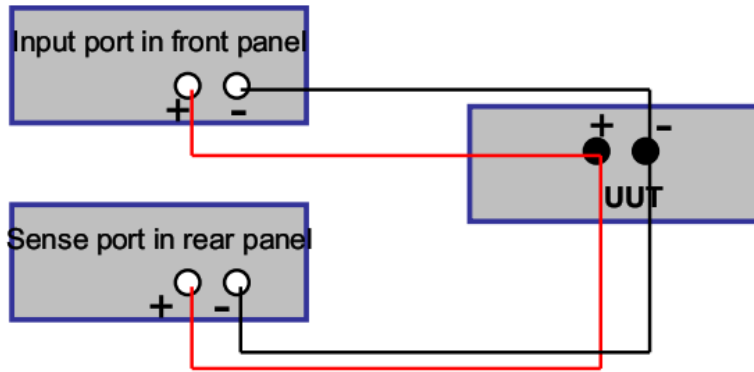

Example: A power supply is connected to the DC load with 72.5 cm of 20-gauge solid copper wires. The constant current i is set to 5 A. The power supply's output meter reads 27.0 V and the DC Load's voltage display reads 26.71 V with a power dissipation of 133.70 W. This is without remote sensing enabled. With remote sensing turned on and the remote sensing terminals connected to the power supply output terminals, the DC Load reads 26.98 V and indicates 134.95 W of power dissipation. This demonstrates that $(134.95 - 133.70) = 1.25$ W is dissipated in the 20-gauge wires. From the resistance per unit length of 20-gauge wires, the expected dissipated power at 5 A can be calculated as 1.21 W.

Saving and Recalling settings

The DC Load provides 25 non-volatile registers to save instrument settings for recall later.

To save the instrument's settings to a register, press **Shift + Store**. You'll be prompted for a register number. Enter a number between 1 and 25, then press the **Enter** key. The settings are saved. Note that this will overwrite any values previously saved in that register.

To recall the instrument's settings from a register, press **Shift + Recall**. You'll be prompted for a register number. Enter a number between 1 and 25, then press the **Enter** key. The stored settings are saved. Note that this will overwrite all values currently set in the instrument.

If you try to recall a register with no data in it, you will get a **NO EEPROM DATA** error message.

Remote operation

Communication cables

The DC Load has a DB9 connector on the rear panel that allows remote communication.

WARNING

Do not connect the DC Load's DB9 connector to a standard RS-232 instrument. Doing so may damage the instrument, as the instrument requires TTL logic signals, not standard RS-232 voltages.

Two adapters are available to perform the correct level shifting.

USB to TTL serial converter cable IT-E132B

The IT-E132B adapter allows you to talk to the DC load via your Windows® computer's USB interface. To use this interface, you must install the software driver that came with the IT-E132B adapter.

To install the driver, run the **PL-2303 Driver Installer.exe** file that comes on the CD. This will install the driver. After installation, right click on **My Computer** and select **Manage**. Click on Device Manager in the left-hand pane, then click on Ports in the right hand pane. You should see an entry named **Prolific USB-to-Serial Comm Port**.

Once the driver software is installed on your system, it will appear as if you have a new COM port. This COM port can then be accessed as if it were a regular RS-232 port.

The LEDs in the adapter will blink when information is being sent through the adapter. This is a good way to tell if your communication link is active.

USB (Virtual COM) settings

In order for the computer to communicate with the DC Load, both must be set to the same serial settings. These communication settings are:

1. Baud rate must be one of 4800, 9600, 19200, or 38400.
2. 8 data bits.
3. One stop bit.
4. No parity.

NOTE: DTR and RTS signal lines must be enabled/asserted.

Overview of DC Load programming

Packet structure

The DC Load is programmed using packets of bytes. A packet always contains 26 bytes, either going to or coming from the instrument. The basic programming rule is:

You send a **26 byte** packet to the instrument. You then read a **26 byte** packet back from the DC Load to either

- Get the status of your submitted packet, or
- Get the data you requested.

The following are conventions we will follow in this chapter:

1. Hexadecimal integers will be represented by the prefix 0x.
2. Numbers are in base 10 number system unless otherwise indicated.
3. Byte numbering is zero-based, meaning numbering starts with 0.

The structure of each 26 byte packet is:

Byte 0	Byte 1	Byte 2	Byte 3 to 24	Byte 25
0xAA	Address	Command	Command's data	Checksum

Thus, the first byte of any command packet or returned packet is always 0xAA.

Address must be a byte that is between 0x00 and 0xFE. Setting of the address is optional. It is not required to communicate with the instrument. The address can be set from the front panel and is stored in non-volatile memory. This feature is useful when communicating via USB, and connecting several instruments, e.g. via a USB hub. In this scenario, Windows assigns a virtual COM port to each device which is unknown prior to establishing communications with the instrument (could be different each time). In this case, the user can correlate each virtual COM port randomly assigned by Windows with a user defined address.

Command is a byte that identifies which DC Load command is used.

The area for the command's data contains parameter information for the command or the data that is requested via a previous command. Some commands have no data at all. It is a good programming practice to set all unused bytes to 0x00.

The checksum number is the arithmetic sum of each of the bytes modulo 256.

Status packets

When you send a command that does not cause the DC Load to send requested information back to you, you will receive a status packet back. The structure of a status packet is

Byte 0	Byte 1	Byte 2	Byte 3	Byte 4 to 24	Byte 25
0xAA	Address	0x12	Status byte	Reserved	Checksum

The meaning of the return status byte is defined below:

0x90	Checksum incorrect
0xA0	Parameter incorrect
0xB0	Unrecognized command
0xC0	Invalid command
0x80	Command was successful

Even for commands that request for data to be read back, if the command is incorrect, the status packet will also be received with one of the above status bytes.

Example program

As you have seen, the native programming interface to the DC loads is fairly low-level. It involves sending 26 byte commands and receiving 26 byte responses from the instrument. To demonstrate how to write your own source code to remotely control the DC load, we provide a custom program written in python which translates well into other text based languages like C/C++

About Python: Python is a dynamic object-oriented programming language that can be used for various kinds of software development. It offers strong support for integration with other languages and tools, comes with extensive standard libraries, and is easy to learn in a few days time. Python is distributed under an OSI-approved open source license that makes it free to use.

You can download a complete python program along with detailed documentation from our website at www.bkprecision.com. Also available under the download area is a high level library which will make programming much easier as it does the low level bit manipulation for you. Instead of sending a 26 byte string, you can send a high level command such as SetMaxCurrent(current)

Example script:

```
# Set DC load to remote mode.

import serial
length_packet = 26 # Number of bytes in a packet

def DumpCommand(bytes):
    assert(len(bytes) == length_packet)
    header = " " * 3
    print header,
    for i in xrange(length_packet):
        if i % 10 == 0 and i != 0:
            print
            print header,
        if i % 5 == 0:
            print " ",
        s = "%02x" % ord(bytes[i])
        if s == "00":
            s = chr(250)*2
        print s,
    print

def CalculateChecksum(cmd):
    assert((len(cmd) == length_packet - 1) or (len(cmd) ==
length_packet))
    checksum = 0
    for i in xrange(length_packet - 1):
        checksum += ord(cmd[i])
    checksum %= 256
    return checksum

def main():
    port = 3 # COM4 for my computer
    baudrate = 38400
    sp = serial.Serial(port, baudrate) # Open a serial connection
    # Construct a set to remote command
    cmd = chr(0xaa) + chr(0x00) + chr(0x20) # First three bytes
```



```

cmd += chr(0x01) + chr(0x00)*(length_packet - 1 - 4)
cmd += chr(CalculateChecksum(cmd))
assert(len(cmd) == length_packet)

# Send command to DC load
sp.write(cmd)
print "Set to remote command:"
DumpCommand(cmd)

# Get response from DC load
response = sp.read(length_packet)
assert(len(response) == length_packet)
print "Response:"
DumpCommand(response)

main()

```

The first three lines of the `main()` function set up a serial port to talk to. The next five lines construct the string that we will send to the DC load. The `chr()` function creates a single character that has the ASCII value of the argument. The `+` symbols allow strings to be concatenated. The expression `chr(0)*a_number` creates a string of ASCII `0x00` characters whose length is `a_number`. The last character is the checksum of the previous 25 characters, calculated for us by the `CalculateChecksum()` function.

When a command is sent to the instrument, you must always request for return data, which will always be another 26 bytes. This is also dumped to the screen.

You can download a complete python program along with detailed documentation from our website at www.bkprecision.com

Here are the printed results when the above script is ran:

```

Set to remote command:
  aa ·· 20 01 ·· ·· ·· ·· ··
  ·· ·· ·· ·· ·· ·· ·· ·· ··
  ·· ·· ·· ·· ·· ·· ·· ·· ··
Response:
  aa ·· 12 80 ·· ·· ·· ·· ··
  ·· ·· ·· ·· ·· ·· ·· ·· ··
  ·· ·· ·· ·· ·· ·· ·· ·· ··

```

The `·` characters represent the bytes with a value of `0x00`. This makes it easier to see the nonzero bytes in the string.

The first byte of a command is always `0xaa` and the second byte is the address of the DC load. The address should be set to 0. The third byte identifies the command "set to remote" and the fourth byte is a 1, which means enable remote mode. If the fourth byte was 0, this command would set the DC load to local mode.

The third byte of the response string is `0x12`, which means this is a packet that gives the status of the last command sent. The fourth byte is `0x80`, which means the command completed successfully.

On the DC load, you should see the `Rmt` annunciator turned on immediately after running the script.

You will also see the **Link** annunciator light up while communications are going on, then blink out after a few seconds.

Press **Shift + Local** to set the DC load back to local mode.

We've learned two key things about the DC load:

1. Commands are always sent as 26 byte packets.
2. For any command you send to the DC load, you must also request the return of a 26 byte packet. This returned packet will either be a status packet or an information packet containing data you requested -- for example, the power level currently set.

Get in the habit of looking at the LEDs on the IT-E132B interfaces. Every command you send to the DC load should result in both the RX and TX LEDs blinking once. If this does not happen, something is wrong with the code, interface, or instrument.

Chapter organization

The remainder of this chapter contains a reference on the syntax of DC Load commands and some example programs. The **Summary of commands** section is a list of the commands, but without details. The **Command details** section explains how to use each command.

Summary of commands

The Byte values in the following table are used to identify the commands to be sent in the command packet (byte 2).

Command Group	Byte	Action
Return data	0x12	Indicates a packet that returns the status of the last command you sent to the DC Load
Remote	0x20	Set the DC Load to remote operation
ON/OFF	0x21	Turn the load ON or OFF
Maximum parameter values	0x22	Set the maximum voltage allowed
	0x23	Read the maximum voltage allowed
	0x24	Set the maximum current allowed
	0x25	Read the maximum current allowed
	0x26	Set the maximum power allowed

Command Group	Byte	Action
	0x27	Read the maximum power allowed
Operation mode	0x28	Set CC, CV, CW, or CR mode
	0x29	Read the mode being used (CC, CV, CW, or CR)
Mode parameters	0x2A	Set CC mode current
	0x2B	Read CC mode current
	0x2C	Set CV mode voltage
	0x2D	Read CV mode voltage
	0x2E	Set CW mode power
	0x2F	Read CW mode power
	0x30	Set CR mode resistance
	0x31	Read CR mode resistance
Transient parameters	0x32	Set CC mode transient current and timing
	0x33	Read CC mode transient parameters
	0x34	Set CV mode transient voltage and timing
	0x35	Read CV mode transient parameters
	0x36	Set CW mode transient power and timing
	0x37	Read CW mode transient parameters
	0x38	Set CR mode transient resistance and timing
	0x39	Read CR mode transient parameters
List operations	0x3A	Select the list operation (CC/CV/CW/CR)
	0x3B	Read the list operation (CC/CV/CW/CR)
	0x3C	Set how lists repeat (ONCE or REPEAT)
	0x3D	Read how lists repeat
	0x3E	Set the number of list steps
	0x3F	Read the number of list steps
	0x40	Set one of the step's current and time values
	0x41	Read one of the step's current and time values
	0x42	Set one of the step's voltage and time values
	0x43	Read one of the step's voltage and time values
	0x44	Set one of the step's power and time values
	0x45	Read one of the step's power and time values
	0x46	Set one of the step's resistance and time values
	0x47	Read one of the step's resistance and time values
	0x48	Set the list file name

Command Group	Byte	Action
	0x49	Read the list file name
	0x4A	Set the memory partitioning for storing lists
	0x4B	Read the memory partitioning for storing list steps
	0x4C	Store the list file
	0x4D	Recall the list file
Battery testing	0x4E	Set minimum voltage in battery testing
	0x4F	Read minimum voltage in battery testing
LOAD ON	0x50	Set timer value of for LOAD ON
	0x51	Read timer value for LOAD ON
	0x52	Disable/enable timer for LOAD ON
	0x53	Read timer state for LOAD ON
Address	0x54	Set communication address
LOCAL	0x55	Enable/disable LOCAL control
Remote sensing	0x56	Enable/disable remote sensing
	0x57	Read the state of remote sensing
Triggering	0x58	Select trigger source
	0x59	Read trigger source
	0x5A	Trigger the electronic load
Store/Recall	0x5B	Store DC Load's settings
	0x5C	Recall DC Load's settings
Function	0x5D	Select FIXED/SHORT/TRAN/LIST/BATTERY function
	0x5E	Get function type (FIXED/SHORT/TRAN/LIST/BATTERY)
Read display values	0x5F	Read input voltage, current, power and relative state
Calibration	0x60	Enter instrument calibration state
	0x61	Get the instrument calibration state
	0x62	Set voltage calibration point index
	0x63	Send the actual voltage to the calibration program
	0x64	Set current calibration point index
	0x65	Send the actual current to the calibration program
	0x66	Store the calibration data to EEPROM
	0x67	Set calibration information
	0x68	Read calibration information
	0x69	Restore the factory default calibration data
Product information	0x6A	Get product's model, serial number, and firmware version

Command Group	Byte	Action
	0x6B	Read the bar code information

Command details

In the following, please remember that the word *mode* only refers to one of the four operational modes of the DC Load: constant current (CC), constant voltage (CV), constant power (CW), or constant resistance (CR).

Notation for tables

In the following sections, we abbreviate the details of the commands. Since the first three bytes of a command are i) the constant 0xAA, ii) the instrument address, and iii) the command, we will not show those for each command. In addition, the 26th byte, the checksum, will also not be shown.

The table includes a column for **Byte offset**. This is the zero-based index of the byte in the packet. Note the offset numbers are in decimal.

A table entry of “Reserved” means the data are currently unused or reserved for future use. Good programming practice is to set these bytes to 0x00.

Some commands require two byte and four byte integers to represent parameter settings. These integers are stored in the command packet in **little-endian** format. Little-endian is a byte ordering format in which bytes with lower addresses have lower significance. We will refer to the individual bytes as follows:

For a two byte integer, the least significant byte will be called the low byte and the most significant byte will be called the high byte.

For a four byte integer, we will use the following notation:

Least significant two bytes, least significant byte	Lower low byte
Least significant two bytes, most significant byte	Lower high byte
Most significant two bytes, least significant byte	Higher low byte
Most significant two bytes, most significant byte	Higher high byte

As an example, for the integer 0x23A749F5, we'd have

1st byte	0xF5 Lower low byte
2nd byte	0x49 Lower high byte
3rd byte	0xA7 Higher low byte
4th byte	0x23 Higher high byte

0x12 Indicates a return packet for a command sent to the DC Load

Byte offset	Meaning
3	Status byte (i.e., status of last command sent to DC Load).
4-24	Reserved

Below is a table of all possible status byte values and their corresponding indication.

0x90	Checksum incorrect
0xA0	Parameter incorrect

0xB0	Unrecognized command
0xC0	Invalid command
0x80	Command was successful

0x20 Set the DC Load to remote operation

Byte offset	Meaning
3	0 means front panel operation. 1 means remote operation.
4-24	Reserved

0x21 Turn the load ON or OFF

Byte offset	Meaning
3	0 is OFF. 1 is ON.
4-24	Reserved

0x22 Set the maximum voltage allowed

Byte offset	Meaning
3	Lower low byte of maximum voltage. 1 represents 1 mV.
4	Lower high byte of maximum voltage.
5	Upper low byte of maximum voltage.
6	Upper high byte of maximum voltage.
7-24	Reserved

Example: Suppose you want to set the maximum voltage to 16.23V. Since 1 represents 1mV, therefore 16.23V translates to 16,230 in decimal. With 4 bytes in Hex, that would be 0x0003F66. Since the bytes are ordered in little-endian format, 0x66 would be the 3rd byte, 0x3F the 4th byte, 0x00 as 5th byte, and 0x00 as the 6th byte.

0x23 Read the maximum voltage allowed

Byte offset	Meaning
3	Lower low byte of maximum voltage. 1 represents 1 mV.
4	Lower high byte of maximum voltage.
5	Upper low byte of maximum voltage.
6	Upper high byte of maximum voltage.

Byte offset	Meaning
7-24	Reserved

0x24 Set the maximum current allowed

Byte offset	Meaning
3	Lower low byte of maximum current. 1 represents 0.1 mA.
4	Lower high byte of maximum current.
5	Upper low byte of maximum current.
6	Upper high byte of maximum current.
7-24	Reserved

Example: Suppose you want to set the maximum current to 3.12A. Since 1 represents 0.1mA, 3.12A translates to 31,200 in decimal. With 4 bytes in Hex, that would be 0x000079E0. Since the bytes are ordered in little-endian format, 0xE0 would be the 3rd byte, 0x79 the 4th byte, 0x00 as 5th byte, and 0x00 as the 6th byte.

0x25 Read the maximum current allowed

Byte offset	Meaning
3	Lower low byte of maximum current. 1 represents 0.1 mA.
4	Lower high byte of maximum current.
5	Upper low byte of maximum current.
6	Upper high byte of maximum current.
7-24	Reserved

0x26 Set the maximum power allowed

Byte offset	Meaning
3	Lower low byte of maximum power. 1 represents 1 mW.
4	Lower high byte of maximum power.
5	Upper low byte of maximum power.
6	Upper high byte of maximum power.
7-24	Reserved

Example: Suppose you want to set the maximum power to 213.45W. Since 1 represents 1mW, 213.45W translates to 213,450 in decimal. With 4 bytes in Hex, that would be 0x000341CA. Since the bytes are ordered in little-endian format, 0xCA would be the 3rd byte, 0x41 the 4th byte, 0x03 as 5th

byte, and 0x00 as the 6th byte.

0x27 Read the maximum power allowed

Byte offset	Meaning
3	Lower low byte of maximum power. 1 represents 1 mW.
4	Lower high byte of maximum power.
5	Upper low byte of maximum power.
6	Upper high byte of maximum power.
7-24	Reserved

0x28 Set CC, CV, CW, or CR mode

Byte offset	Meaning
3	Mode: 0 is CC 1 is CV 2 is CW 3 is CR
4-24	Reserved

0x29 Read the mode being used (CC, CV, CW, or CR)

Byte offset	Meaning
3	Mode: 0 is CC 1 is CV 2 is CW 3 is CR
4-24	Reserved

0x2A Set CC mode current

Byte offset	Meaning
3	Lower low byte of current. 1 represents 0.1 mA.
4	Lower high byte of current.
5	Upper low byte of current.
6	Upper high byte of current.
7-24	Reserved

0x2B Read CC mode current

Byte offset	Meaning
3	Lower low byte of current. 1 represents 0.1 mA.
4	Lower high byte of current.
5	Upper low byte of current.
6	Upper high byte of current.
7-24	Reserved

0x2C Set CV mode voltage

Byte offset	Meaning
3	Lower low byte of voltage. 1 represents 1 mV.
4	Lower high byte of voltage.
5	Upper low byte of voltage.
6	Upper high byte of voltage.
7-24	Reserved

0x2D Read CV mode voltage

Byte offset	Meaning
3	Lower low byte of voltage. 1 represents 1 mV.
4	Lower high byte of voltage.
5	Upper low byte of voltage.
6	Upper high byte of voltage.
7-24	Reserved

0x2E Set CW mode power

Byte offset	Meaning
3	Lower low byte of power. 1 represents 1 mW.
4	Lower high byte of power.
5	Upper low byte of power.
6	Upper high byte of power.
7-24	Reserved

0x2F Read CW mode power

Byte offset	Meaning
3	Lower low byte of power. 1 represents 1 mW.

Byte offset	Meaning
4	Lower high byte of power.
5	Upper low byte of power.
6	Upper high byte of power.
7-24	Reserved

0x30 Set CR mode resistance

Byte offset	Meaning
3	Lower low byte of resistance. 1 represents 1 mΩ.
4	Lower high byte of resistance.
5	Upper low byte of resistance.
6	Upper high byte of resistance.
7-24	Reserved

0x31 Read CR mode resistance

Byte offset	Meaning
3	Lower low byte of resistance. 1 represents 1 mΩ.
4	Lower high byte of resistance.
5	Upper low byte of resistance.
6	Upper high byte of resistance.
7-24	Reserved

0x32 Set CC mode transient current and timing

Byte offset	Meaning
3 to 6	Value A of current in units of 0.1 mA. Little-endian 4 byte number.
7 to 8	Time for A current in units of 0.1 ms. Little-endian 2 byte number.
9 to 12	Value B of current in units of 0.1 mA. Little-endian 4 byte number.
13 to 14	Time for B current in units of 0.1 ms. Little-endian 2 byte number.
15	Transient operation: 0 is CONTINUOUS 1 is PULSE 2 is TOGGLED
16-24	Reserved

0x33 Read CC mode transient parameters

Byte offset	Meaning
3 to 6	Value A of current in units of 0.1 mA. Little-endian 4 byte number.
7 to 8	Time for A current in units of 0.1 ms. Little-endian 2 byte number.
9 to 12	Value B of current in units of 0.1 mA. Little-endian 4 byte number.
13 to 14	Time for B current in units of 0.1 ms. Little-endian 2 byte number.
15	Transient operation: 0 is CONTINUOUS 1 is PULSE 2 is TOGGLED
16-24	Reserved

0x34 Set CV mode transient voltage and timing

Byte offset	Meaning
3 to 6	Value A of voltage in units of 1 mV. Little-endian 4 byte number.
7 to 8	Time for A voltage in units of 0.1 ms. Little-endian 2 byte number.
9 to 12	Value B of voltage in units of 1 mV. Little-endian 4 byte number.
13 to 14	Time for B voltage in units of 0.1 ms. Little-endian 2 byte number.
15	Transient operation: 0 is CONTINUOUS 1 is PULSE 2 is TOGGLED
16-24	Reserved

0x35 Read CV mode transient parameters

Byte offset	Meaning
3 to 6	Value A of voltage in units of 1 mV. Little-endian 4 byte number.
7 to 8	Time for A voltage in units of 0.1 ms. Little-endian 2 byte number.
9 to 12	Value B of voltage in units of 1 mV. Little-endian 4 byte number.
13 to 14	Time for B voltage in units of 0.1 ms. Little-endian 2 byte number.
15	Transient operation: 0 is CONTINUOUS 1 is PULSE 2 is TOGGLED
16-24	Reserved

0x36 Set CW mode transient power and timing

Byte offset	Meaning
3 to 6	Value A of power in units of 1 mW. Little-endian 4 byte number.
7 to 8	Time for A power in units of 0.1 ms. Little-endian 2 byte number.
9 to 12	Value B of power in units of 1 mW. Little-endian 4 byte number.
13 to 14	Time for B power in units of 0.1 ms. Little-endian 2 byte number.
15	Transient operation: 0 is CONTINUOUS 1 is PULSE 2 is TOGGLED
16-24	Reserved

0x37 Read CW mode transient parameters

Byte offset	Meaning
3 to 6	Value A of power in units of 1 mW. Little-endian 4 byte number.
7 to 8	Time for A power in units of 0.1 ms. Little-endian 2 byte number.
9 to 12	Value B of power in units of 1 mW. Little-endian 4 byte number.
13 to 14	Time for B power in units of 0.1 ms. Little-endian 2 byte number.
15	Transient operation: 0 is CONTINUOUS 1 is PULSE 2 is TOGGLED
16-24	Reserved

0x38 Set CR mode transient resistance and timing

Byte offset	Meaning
3 to 6	Value A of resistance in units of 1 mΩ. Little-endian 4 byte number.
7 to 8	Time for A resistance in units of 0.1 ms. Little-endian 2 byte number.
9 to 12	Value B of resistance in units of 1 mΩ. Little-endian 4 byte number.
13 to 14	Time for B resistance in units of 0.1 ms. Little-endian 2 byte number.
15	Transient operation: 0 is CONTINUOUS 1 is PULSE 2 is TOGGLED
16-24	Reserved

0x39 Read CR mode transient parameters

Byte offset	Meaning
3 to 6	Value A of resistance in units of 1 mΩ. Little-endian 4 byte number.
7 to 8	Time for A resistance in units of 0.1 ms. Little-endian 2 byte number.
9 to 12	Value B of resistance in units of 1 mΩ. Little-endian 4 byte number.
13 to 14	Time for B resistance in units of 0.1 ms. Little-endian 2 byte number.
15	Transient operation: 0 is CONTINUOUS 1 is PULSE 2 is TOGGLED
16-24	Reserved

0x3A Select the list operation (CC/CV/CW/CR)

Byte offset	Meaning
3	List operation mode: 0 is constant current (CC) 1 is constant voltage (CV) 2 is constant power (CW) 3 is constant resistance (CR)
4-24	Reserved

0x3B Read the list operation (CC/CV/CW/CR)

Byte offset	Meaning
3	List operation mode: 0 is constant current (CC) 1 is constant voltage (CV) 2 is constant power (CW) 3 is constant resistance (CR)
4-24	Reserved

0x3C Set how lists repeat (ONCE or REPEAT)

Byte offset	Meaning
3	How lists repeat: 0 is ONCE 1 is REPEAT
4-24	Reserved

0x3D Read how lists repeat (ONCE or REPEAT)

Byte offset	Meaning
3	How lists repeat: 0 is ONCE 1 is REPEAT
4-24	Reserved

0x3E Set the number of list steps

Byte offset	Meaning
3 to 4	2 byte little-endian integer for number of steps
5-24	Reserved

0x3F Read the number of list steps

Byte offset	Meaning
3 to 4	2 byte little-endian integer for number of steps
5-24	Reserved

0x40 Set one of the step's current and time values

Byte offset	Meaning
3 to 4	2 byte little-endian integer specifying which step number in the list
5 to 8	4 byte little-endian integer specifying the current in units of 0.1 mA
9 to 10	2 byte little-endian integer specifying the step timing in units of 0.1 ms
11-24	Reserved

0x41 Read one of the step's current and time values

Byte offset	Meaning
3 to 4	2 byte little-endian integer specifying which step number in the list
5 to 8	4 byte little-endian integer specifying the current in units of 0.1 mA
9 to 10	2 byte little-endian integer specifying the step timing in units of 0.1 ms
11-24	Reserved

0x42 Set one of the step's voltage and time values

Byte offset	Meaning
3 to 4	2 byte little-endian integer specifying which step number in the list
5 to 8	4 byte little-endian integer specifying the voltage in units of 1 mV

Byte offset	Meaning
9 to 10	2 byte little-endian integer specifying the step timing in units of 0.1 ms
11-24	Reserved

0x43 Read one of the step's voltage and time values

Byte offset	Meaning
3 to 4	2 byte little-endian integer specifying which step number in the list
5 to 8	4 byte little-endian integer specifying the voltage in units of 1 mV
9 to 10	2 byte little-endian integer specifying the step timing in units of 0.1 ms
11-24	Reserved

0x44 Set one of the step's power and time values

Byte offset	Meaning
3 to 4	2 byte little-endian integer specifying which step number in the list
5 to 8	4 byte little-endian integer specifying the power in units of 1 mW
9 to 10	2 byte little-endian integer specifying the step timing in units of 0.1 ms
11-24	Reserved

0x45 Read one of the step's power and time values

Byte offset	Meaning
3 to 4	2 byte little-endian integer specifying which step number in the list
5 to 8	4 byte little-endian integer specifying the power in units of 1 mW
9 to 10	2 byte little-endian integer specifying the step timing in units of 0.1 ms
11-24	Reserved

0x46 Set one of the step's resistance and time values

Byte offset	Meaning
3 to 4	2 byte little-endian integer specifying which step number in the list
5 to 8	4 byte little-endian integer specifying the resistance in units of 1 m Ω
9 to 10	2 byte little-endian integer specifying the step timing in units of 0.1 ms
11-24	Reserved

0x47 Read one of the step's resistance and time values

Byte offset	Meaning
3 to 4	2 byte little-endian integer specifying which step number in the list
5 to 8	4 byte little-endian integer specifying the resistance in units of 1 mΩ
9 to 10	2 byte little-endian integer specifying the step timing in units of 0.1 ms
11-24	Reserved

0x48 Set the list file name

Byte offset	Meaning
3 to 12	List file name (ASCII characters)
13-24	Reserved

0x49 Read the list file name

Byte offset	Meaning
3 to 12	List file name (ASCII characters)
13-24	Reserved

0x4A Set the memory partitioning for storing lists

Byte offset	Meaning
3	Partition scheme: 1 means 1 file of 1000 list steps 2 means 2 files of 500 list steps 4 means 4 files of 250 list steps 8 means 8 files of 120 list steps
4-24	Reserved

0x4B Read the memory partitioning for storing list steps

Byte offset	Meaning
3	Partition scheme: 1 means 1 file of 1000 list steps 2 means 2 files of 500 list steps 4 means 4 files of 250 list steps 8 means 8 files of 120 list steps
4-24	Reserved

0x4C Save the list file

Byte offset	Meaning
3	Storage location, a one byte integer from 1 to 8. This number must be consistent with the number of list files allowed as set by the 0x4A command.
4-24	Reserved

0x4D Recall the list file

Byte offset	Meaning
3	Storage location, a one byte integer from 1 to 8.
4-24	Reserved

0x4E Set minimum voltage in battery testing

Byte offset	Meaning
3 to 6	4 byte little-endian integer specifying the minimum voltage in units of 1 mV
7-24	Reserved

0x4F Read minimum voltage in battery testing

Byte offset	Meaning
3 to 6	4 byte little-endian integer specifying the minimum voltage in units of 1 mV
7-24	Reserved

0x50 Set timer value of for LOAD ON

Byte offset	Meaning
3 to 4	2 byte little-endian integer specifying the time in units of 1 second
5-24	Reserved

0x51 Read timer value for LOAD ON

Byte offset	Meaning
3 to 4	2 byte little-endian integer specifying the time in units of 1 second
5-24	Reserved

0x52 Disable/enable timer for LOAD ON

Byte offset	Meaning
3	0 is disable timer 1 is enable timer

Byte offset	Meaning
4-24	Reserved

0x53 Read timer state for LOAD ON

Byte offset	Meaning
3	0 is disable timer 1 is enable timer
4-24	Reserved

0x54 Set communication address

Byte offset	Meaning
3	2 byte little-endian integer specifying the address. Must be between 0 and 0xFE, inclusive.
4-24	Reserved

0x55 Enable/disable LOCAL control

Byte offset	Meaning
3	0 means to disable the Local key on the front panel 1 means to enable the Local key on the front panel
4-24	Reserved

0x56 Enable/disable remote sensing

Byte offset	Meaning
3	0 means to disable remote sensing 1 means to enable remote sensing
4-24	Reserved

0x57 Read the state of remote sensing

Byte offset	Meaning
3	0 means remote sensing is disabled 1 means remote sensing is enabled
4-24	Reserved

0x58 Select trigger source

Byte offset	Meaning
3	Trigger: 0 means immediate trigger (i.e., triggered from the front panel) 1 means external trigger from the rear panel connector 2 means a bus (software) trigger (the 0x5A command)
4-24	Reserved

0x59 Read trigger source

Byte offset	Meaning
3	Trigger: 0 means immediate trigger (i.e., triggered from the front panel) 1 means external trigger from the rear panel connector 2 means a bus (software) trigger (the 0x5A command)
4-24	Reserved

0x5A Trigger the electronic load

Byte offset	Meaning
3-24	Reserved

0x5B Save DC Load's settings

Byte offset	Meaning
3	Storage register, a number between 1 and 25 inclusive
4-24	Reserved

0x5C Recall DC Load's settings

Byte offset	Meaning
3	Storage register, a number between 1 and 25 inclusive
4-24	Reserved

0x5D Select *FIXED*/*SHORT*/*TRAN*/*LIST*/*BATTERY* function

Byte offset	Meaning
3	Function: 0 means FIXED 1 means SHORT 2 means TRANSIENT 3 means LIST 4 means BATTERY

Byte offset	Meaning
4-24	Reserved

0x5E Get function type (FIXED/SHORT/TRAN/LIST/BATTERY)

Byte offset	Meaning
3	Function: 0 means FIXED 1 means SHORT 2 means TRANSIENT 3 means LIST 4 means BATTERY
4-24	Reserved

0x5F Read input voltage, current, power and relative state

Byte offset	Meaning
3 to 6	4 byte little-endian integer for terminal voltage in units of 1 mV
7 to 10	4 byte little-endian integer for terminal current in units of 0.1 mA
11 to 14	4 byte little-endian integer for terminal power in units of 1 mW
15	Operation state register (see bit list below)
16 to 17	2 byte little-endian integer for demand state register (see bit list below)
18-24	Reserved

The operation state register's bit meanings are:

Bit	Meaning
0	Calculate the new demarcation coefficient
1	Waiting for a trigger signal
2	Remote control state (1 means enabled)
3	Output state (1 means ON)
4	Local key state (0 means not enabled, 1 means enabled)
5	Remote sensing mode (1 means enabled)
6	LOAD ON timer is enabled
7	Reserved

The demand state register's bit meanings are:

Bit	Meaning
0	Reversed voltage is at instrument's terminals (1 means yes)

Bit	Meaning
1	Over voltage (1 means yes)
2	Over current (1 means yes)
3	Over power (1 means yes)
4	Over temperature (1 means yes)
5	Not connect remote terminal
6	Constant current
7	Constant voltage
8	Constant power
9	Constant resistance

0x6A Get product's model, serial number, and firmware version

Byte offset	Meaning
3 to 7	ASCII model information
8	Low byte of firmware version number
9	High byte of firmware version number
10 to 19	Instrument's serial number in ASCII
20-24	Reserved

0x6B Read the bar code information

Note: the bar code information is to be interpreted as ASCII data.

Byte offset	Meaning
3 to 5	Identity
6 to 7	Sub
7 to 9	Version
10 to 11	Year
12-24	Reserved

Serial number and firmware version

To find out the serial number and firmware version of the DC load, turn the instrument on. While the **SYSTEM SELFTEST** message is displayed, quickly press and hold down the **Shift** key. By pressing the **▲** and **▼** keys, you will see the following information:

120V 30A 320W	Instrument's capabilities
SN: XXX-XXX-XXX	Serial number
VER: X.XX	Firmware version

Press the **Esc** key to return to normal operation of the instrument.

In case of trouble

Instrument won't turn on

If the instrument won't turn on when the **POWER** switch is pressed in, please ensure the power cord is plugged into the back of the instrument and the other end of the cord is plugged into a live AC power outlet.

If the instrument still won't turn on, remove the power cord from the instrument. Open the fuse container on the rear panel and check the fuse for continuity.

If the fuse is an open circuit, replace it with the proper fuse indicated in the following table:

Model	Fuse specification for 110 VAC operation	Fuse specification for 220 VAC operation
8500	T0.5A, 250 VAC	T0.3A, 250 VAC
8502	T0.5A, 250 VAC	T0.3A, 250 VAC
8510	T1.25A, 250 VAC	T650 mA, 250 VAC
8512	T2.5A, 250 VAC	T1.25A, 250 VAC
8514	T2.5A, 250 VAC	T1.25A, 250 VAC
8518	T2.5A, 250 VAC	T1.25A, 250 VAC
8520	T2.5A, 250 VAC	T1.25A, 250 VAC
8522	T2.5A, 250 VAC	T1.25A, 250 VAC
8524	T5A, 250 VAC	T2.5A, 250VAC (For 8524-220V)
8526	T5A, 250 VAC	T2.5A, 250VAC (For 8526-220V)

WARNING

Ensure that the fuse is rated for 250 VAC operation. Lower voltage rated fuses are not suitable for this instrument.

Error messages during power-up

EEPROM ERROR means the calibration data have been lost or the EEPROM is not functional.

ERROR CAL.DATA means that the calibration data have been lost.

If you experience these error messages, the instrument should be returned to B&K Precision for service.

Keypad unlock procedure (Keypad was accidentally locked)

If you accidentally locked the keyboard, follow this procedure to unlock: The procedure below shows how to unlock a model 8500 using "8512" as the unlock key.

- 1) Press **Shift + Menu**. You will see **PASSWORD:** displayed on the screen. Enter 8512, then press the **Enter** key. Now you will see **Connect** on the display
- 2) Press **Enter**, locate menu Key Lock set, press **Enter**. Enter **8512**, confirm with **Enter**, press

Enter again. Now the password is cleared. Press **Esc** to exit the menu

To unlock the other DC load models, use the following unlock keys:

Model number	Unlock key code
8500	8512
8502	8512
8510	8513
8512	8513
8514	8514
8518	8518
8520	8516
8522	8516
8524	8518
8526	8518

Frequency Asked Questions

Q: I cannot communicate with the instrument with my PC.

A: Check that the baudrate, address, and parity settings are configured correctly. The baudrate and address settings inside the instrument menu (Accessible under Config menu; see Menus section for details) must match the configurations of your computer's software interface, such as the PV8500 software. If you are using the IT-E132 TTL to USB adapter cable, be sure to check from "Device Manager" in Windows to verify the COM port to which the adapter is assigned to.

Q: My load is rated for 30 A, but I cannot seem to adjust the current beyond 15 A.

A: The 8500 series has a user configurable input limit protection that can be set from the front panel. To verify and edit these settings, press Shift + 0 to access the menu, then use the arrow keys or rotary knob to select SYSTEM SET menu. Press Enter, and there will be menu options for MAX CURRENT SET, MAX VOLTAGE SET, and MAX POWER SET. Respectively, these parameters set the maximum input current, voltage, and power limit to the load. They must be set higher than the value that you want to set in your application. Verify and change MAX CURRENT SET, and you should be able to set to a higher current value. Be sure to press Enter after you change the values so that the changes get saved. Also, note that MAX POWER SET takes priority in limiting the input. For example, suppose you are using 8500, rated for 120V, 30A, 300W, and your MAX POWER SET = 100 W. You want to run CC mode and sink 5 A from a source that has 50 V. Even if your MAX CURRENT SET = 30 A and MAX VOLTAGE SET = 120 V, the load will limit your maximum settable current to 2 A. This is because the configuration for maximum power limit is set to 100 W. For a 50 V source, 2 A of current will have reached the 100 W limit.

Q: I have configured my load and turned on the input, but nothing seems to be sinking. The current shows 0.00 A as if nothing is happening.

A: There are 2 conditional parameters in the SYSTEM SET menu that is used for specific test applications. These parameters can affect the control of the input depending on the applicable conditions. To disable or operate the load under normal conditions, press Shift + 0 to access the menu system. Go to SYSTEM SET, and press Enter. Scroll until you see VOLTAGE ON SET and VOLTAGE OFF SET. Press Enter into each of them and set both parameters to 0.00 V. Be sure to press Enter again after changing the value so that the changes get saved.

Q: I changed some parameter settings, but my changes don't seem to apply.

A: Every time a menu option or parameter is changed, you must press Enter to save those changes before exiting the menu. Exiting the menu without doing this will void any changes made.

Q: How do I get the load to display more resolution from the PV8500 software?

A: When the PV8500 is starting communication, it sets all parameters to some default values. This includes setting the range to default (10 mV, 1 mA resolution). To operate the PV8500 software in low range where an extra digit of resolution can be used, first initialize and run the PV8500. Once the load is connected to the software and communicating, use the software switch at the bottom to change from PC Control to Panel Control. While the load is remained connected, front panel operation is enabled at this point. Press Shift + 0 to go into the Menu system, and go into Config menu. Select RANGE SELECT and set it to ON. Press Enter to save. Now, exit the menu system by pressing Esc a few times. Press Shift + Up arrow to enable 1 mV resolution, and Shift + Down arrow to enable 0.1 mA resolution. Once set, go back to the PV8500 GUI soft panel and change the switch from Panel Control to PC control.

Appendix: Service and warranty information

SERVICE INFORMATION

Warranty Service: Please go to the service and support section on our website www.bkprecision.com to obtain an RMA #. Return the product in the original packaging with proof of purchase to the address below. . Clearly state on the RMA form the performance problem and return any leads, probes, connectors and accessories that you are using with the device.

Non-Warranty Service: Please go to the service and support section on our website www.bkprecision.com to obtain an RMA #. Return the product in the original packaging to the address below. Clearly state on the RMA form the performance problem and return any leads, probes, connectors and accessories that you are using with the device. Customers not on open account must include payment in the form of a money order or credit card. For the most current repair charges please refer to the service and support section on our website.

Return all merchandise to B&K Precision Corp. with prepaid shipping. The flat-rate repair charge for Non-Warranty Service does not include return shipping. Return shipping to locations in North American is included for Warranty Service. For overnight shipments and non-North American shipping fees please contact B&K Precision Corp.

B&K Precision Corp.
22820 Savi Ranch Parkway
Yorba Linda, CA 92887
www.bkprecision.com
714-921-9095

Include with the returned instrument your complete return shipping address, contact name, phone number and description of problem.

LIMITED ONE-YEAR WARRANTY

B&K Precision Corp. warrants to the original purchaser that its products and the component parts thereof, will be free from defects in workmanship and materials for a period of one year from date of purchase.

B&K Precision Corp. will, without charge, repair or replace, at its option, defective product or component parts. Returned product must be accompanied by proof of the purchase date in the form of a sales receipt.

To help us better serve you, please complete the warranty registration for your new instrument via our website at www.bkprecision.com.

Exclusions: This warranty does not apply in the event of misuse or abuse of the product or as a result of unauthorized alterations or repairs. The warranty is void if the serial number is altered, defaced or removed.

B&K Precision Corp. shall not be liable for any consequential damages, including without limitation damages resulting from loss of use. Some states do not allow limitations of incidental or consequential damages. So the above limitation or exclusion may not apply to you.

This warranty gives you specific rights and you may have other rights, which vary from state-to-state.

B&K Precision Corp.
22820 Savi Ranch Parkway
Yorba Linda, CA 92887
www.bkprecision.com
714-921-9095

Index

Battery.....	21	Mode settings.....	29
Battery test.....	7, 21, 32	P-set.....	21
CC.....	21	Present a constant resistance.....	6
Condition.....	21	R-set.....	22
Constant current.....	9, 11, 21, 29	Recall.....	10, 12, 22, 43
Constant power.....	9, 11, 21, 30	Remote sensing.....	11p., 22, 42
Constant resistance.....	9, 11, 21p., 31	Resistance.....	31
Constant voltage.....	9, 11, 21p., 30	Resistance	31
CR.....	21	S-Tran.....	22
CV.....	21	Shift.....	11, 22
CW.....	21	Shift + Δ	32
Draw a constant current.....	6	Shift + ∇	32
Draw a constant power.....	6	Short.....	10, 12, 22, 32
Draw a constant voltage.....	6	Standard display.....	34pp.
Dynamic condition.....	21	Store.....	10, 22
Enter.....	10, 13	Tran.....	22
Esc.....	10, 12	Transient condition.....	22
I-set.....	21	Transient mode.....	21
List.....	11, 13p., 21, 36	Trigger.....	11pp., 22, 39
Local.....	11, 21	V-set.....	22
Menu.....	8, 12, 21	Δ	32
Menu system.....	10	∇	21
Mode.....	21		



22820 Savi Ranch Parkway Yorba Linda CA, 92887

Printed in China