

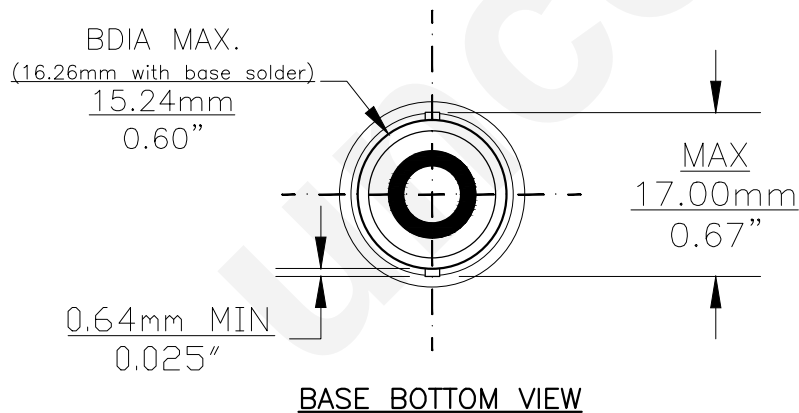

PART NO.	BASE TYPE	DESIGN VOLTS	DESIGN AMPS	MSCD	FILAMENT TYPE	AVERAGE LIFE HOURS	REVISIONS			
							REV #	DESCRIPTION	DATE	APPROVED
209	S.C. Bayonet (BA15s)	6.5V	1.78±10%	15±15%	C-6	100	1	ISSUED	05/28/2014	R.M.

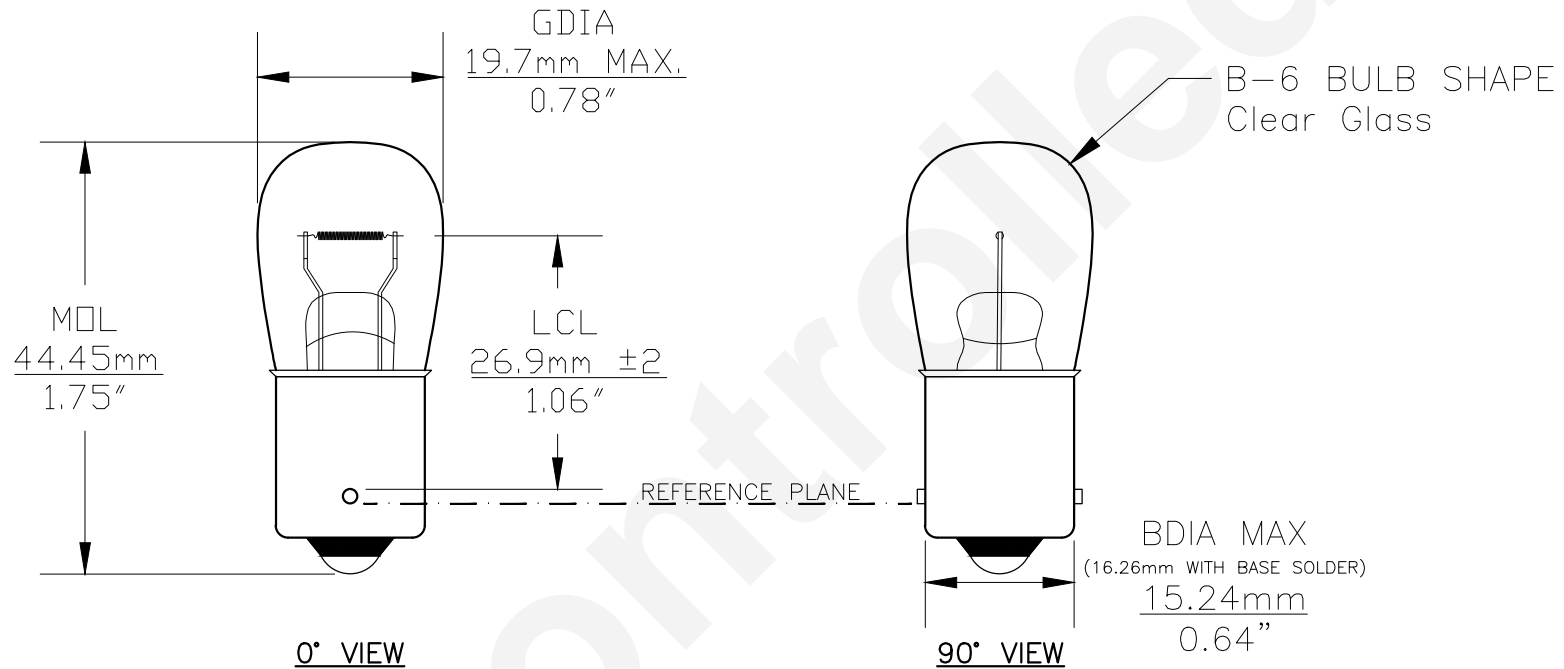

Note: Made according to SAE specifications



UNLESS OTHERWISE SPECIFIED: DIMENSIONS ARE IN INCHES TOLERANCES		CEC INDUSTRIES LTD			
DECIMALS	ANGULAR	599 BOND STREET		LINCOLNSHIRE, IL 60069	
.XX ± .05	± 0.5°	TITLE LIGHT BULB NO. 209			
.XXX ± .010		SIZE A	FSCM NO.	DWG NO. 209	REV 1
FRACTIONAL	± 1/64	SCALE		PLOT SCALE	SHEET 1 OF 1
DRAWN ROSE MEDINA		DATE 05/28/2014		MATERIAL	
CHECKED		FILE 209.pdf		DRAWING NOT TO SCALE	