



TAOGLAS®



Datasheet

MCS6.A

Description:

NB-IoT / CAT M1 Low Profile 4G SMD Dielectric Antenna

Features:

GSM / CDMA / DCS / PCS / WCDMA / UMTS / HSDPA / GPRS / EDGE

NB-IoT / CAT M1 Bands

698~960MHz / 1710~2690MHz

High Efficiency Multi-Band SMD antenna

Low profile 42*10*3mm

RoHS & REACH Compliant

1. Introduction	3
2. Specifications	4
3. Antenna Characteristics	5
4. 2D Radiation Patterns	8
5. 3D Radiation Patterns	17
6. Mechanical Drawing	20
7. Footprint	21
8. Packaging	22
<hr/>	
Changelog	23

Taoglas makes no warranties based on the accuracy or completeness of the contents of this document and reserves the right to make changes to specifications and product descriptions at any time without notice. Taoglas reserves all rights to this document and the information contained herein.

Reproduction, use or disclosure to third parties without express permission is strictly prohibited.

Copyright © Taoglas Ltd.



1. Introduction



The MCS6.A is a low profile SMD NB-IoT / CAT M1 Bands / 4G/3G/2G embedded antenna designed for direct SMD mount on a device PCB. It provides high efficiency in a very small form factor of just 42*10*3mm.

NB-IoT / CAT M1 is a low power wide area (LPWA) technology specifically designed for IoT and M2M. NB-IoT / CAT M1 technology offers lower maintenance cost, with greater efficiency and reliability by reducing power consumption and providing deeper penetration compared to standard cellular technologies. It operates on secure mobile networks making it suited to automotive, smart meter, medical and smart city applications.

If tuning is required, the MCS6.A can be tuned for the device environment without the need for new tooling. Its rectangular shape and very small size make it very easy to integrate. It is supplied on tape and reel ensuring that it can be mounted via pick and place to reflow solder directly on the edge of the PCB board.

This antenna is recommended to be used with longer ground-plane lengths of 120mm or more to attain its highest rated efficiency. Note the Return Loss and Efficiency graphs on Page 16.

Contact your regional Taoglas Customer Support Team for quick and professional support from our senior engineering team on integration and matching of the antenna to your device.

2. Specifications

Electrical							
Frequency (MHz)		Band 2		Band 4		Band 12	
		Tx	Rx	Tx	Rx	Tx	Rx
		1850-1910	1930-1990	1710-1755	2110-2155	699-716	729-746
Peak Gain (dBi)							
On Evaluation Board		2.76	3.26	3.11	3.75	-1.05	-0.02
Average Gain (dB)							
On Evaluation Board		-2.04	-1.67	-1.65	-1.85	-3.50	-2.25
Efficiency (%)							
On Evaluation Board		62.46	67.47	68.33	65.67	44.58	59.60
Return Loss(dB)							
On Evaluation Board	Typical	<-10	<-10	<-10	<-10	<-10	<-10
On Evaluation Board	Band Edge	<-6	<-6	<-7	<-7	<-5	<-5
Impedance		50Ω					
Polarization		Linear					
Maximum Input Power		5W					
Mechanical							
Antenna Dimensions		42mm x 10mm x 3mm					
Material		FR4					
Weight		2.50g					
Soldering Type		SMT through Reflow					
Environmental							
Operation Temperature		-40°C ~ +85°C					
Storage Temperature		-40°C ~ +85°C					

*All measurements were done on 123*45mm Evaluation board with 100mm length ground plane.

5G/4G Bands			
Band Number	5G NR / FR1 / LTE / LTE-Advanced / WCDMA / HSPA / HSPA+ / TD-SCDMA		
	Uplink	Downlink	Covered
1	UL: 1920 to 1980	DL: 2110 to 2170	✓
2	UL: 1850 to 1910	DL: 1930 to 1990	✓
3	UL: 1710 to 1785	DL: 1805 to 1880	✓
4	UL: 1710 to 1755	DL: 2110 to 2155	✓
5	UL: 824 to 849	DL: 869 to 894	✓
7	UL: 2500 to 2570	DL: 2620 to 2690	✓
8	UL: 880 to 915	DL: 925 to 960	✓
9	UL: 1749.9 to 1784.9	DL: 1844.9 to 1879.9	✓
11	UL: 1427.9 to 1447.9	DL: 1475.9 to 1495.9	✓
12	UL: 699 to 716	DL: 729 to 746	✓
13	UL: 777 to 787	DL: 746 to 756	✓
14	UL: 788 to 798	DL: 758 to 768	✓
17	UL: 704 to 716	DL: 734 to 746 (LTE only)	✓
18	UL: 815 to 830	DL: 860 to 875 (LTE only)	✓
19	UL: 830 to 845	DL: 875 to 890	✓
20	UL: 832 to 862	DL: 791 to 821	✓
21	UL: 1447.9 to 1462.9	DL: 1495.9 to 1510.9	✓
22	UL: 3410 to 3490	DL: 3510 to 3590	✓
23	UL: 2000 to 2020	DL: 2180 to 2200 (LTE only)	✓
24	UL: 1625.5 to 1660.5	DL: 1525 to 1559 (LTE only)	✓
25	UL: 1850 to 1915	DL: 1930 to 1995	✓
26	UL: 814 to 849	DL: 859 to 894	✓
27	UL: 807 to 824	DL: 852 to 869 (LTE only)	✓
28	UL: 703 to 748	DL: 758 to 803 (LTE only)	✓
29	UL: -	DL: 717 to 728 (LTE only)	✓
30	UL: 2305 to 2315	DL: 2350 to 2360 (LTE only)	✗
31	UL: 452.5 to 457.5	DL: 462.5 to 467.5 (LTE only)	✗
32	UL: -	DL: 1452 - 1496	✗
35		1850 to 1910	✓
38		2570 to 2620	✓
39		1880 to 1920	✓
40		2300 to 2400	✗
41		2496 to 2690	✓
42		3400 to 3600	✗
43		3600 to 3800	✗
48		3550 to 3700	✗
66	UL: 1710-1780	DL: 2110-2200	✓
71		617 to 698	✗
74/75/76		1427 to 1518	✗
78		3300 to 3800	✗
79		4400 to 5000	✗

*Covered Bands Represent Efficiency over 20%

3. Antenna Characteristics

3.1 Return Loss

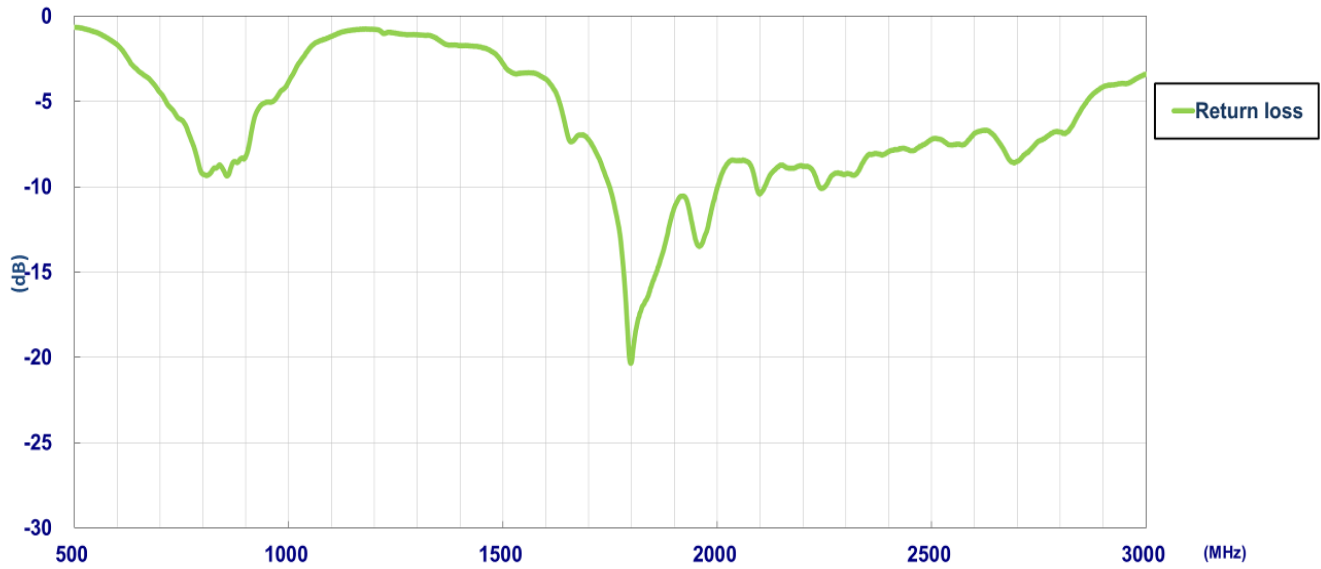

3.2 Efficiency

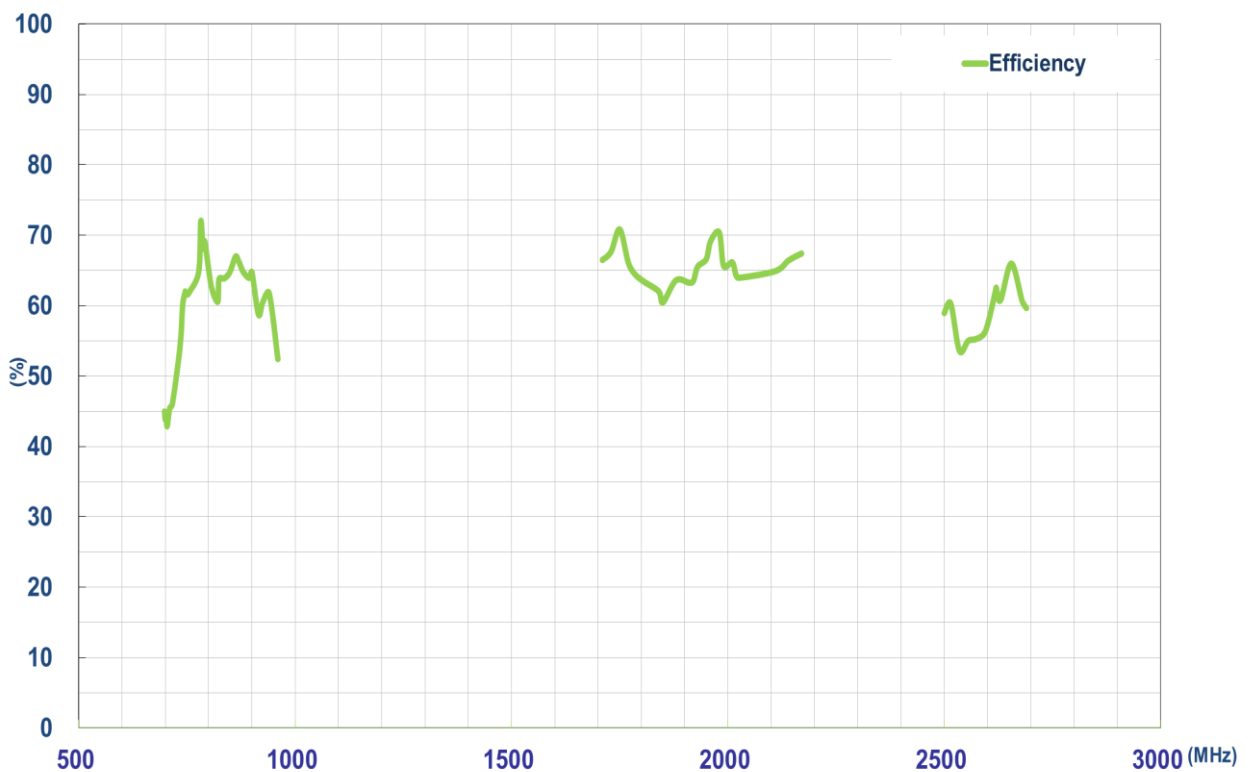

3.3 Average Gain

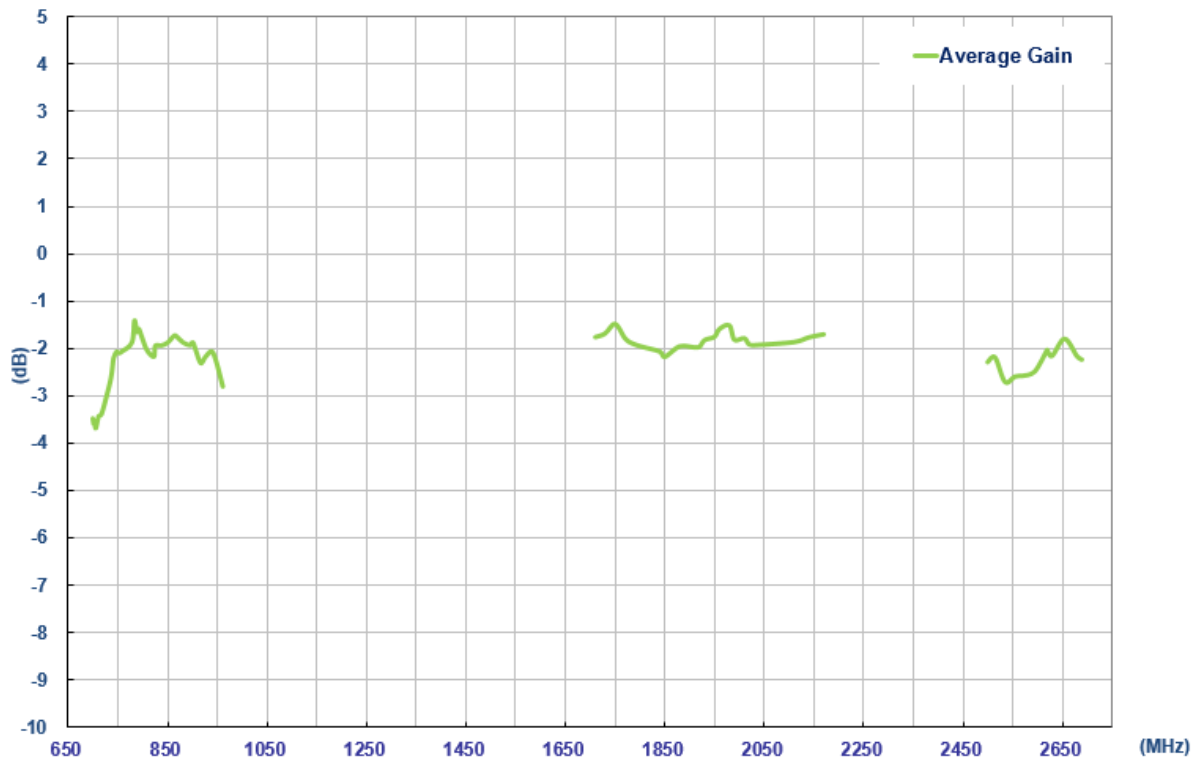

3.4 Peak Gain

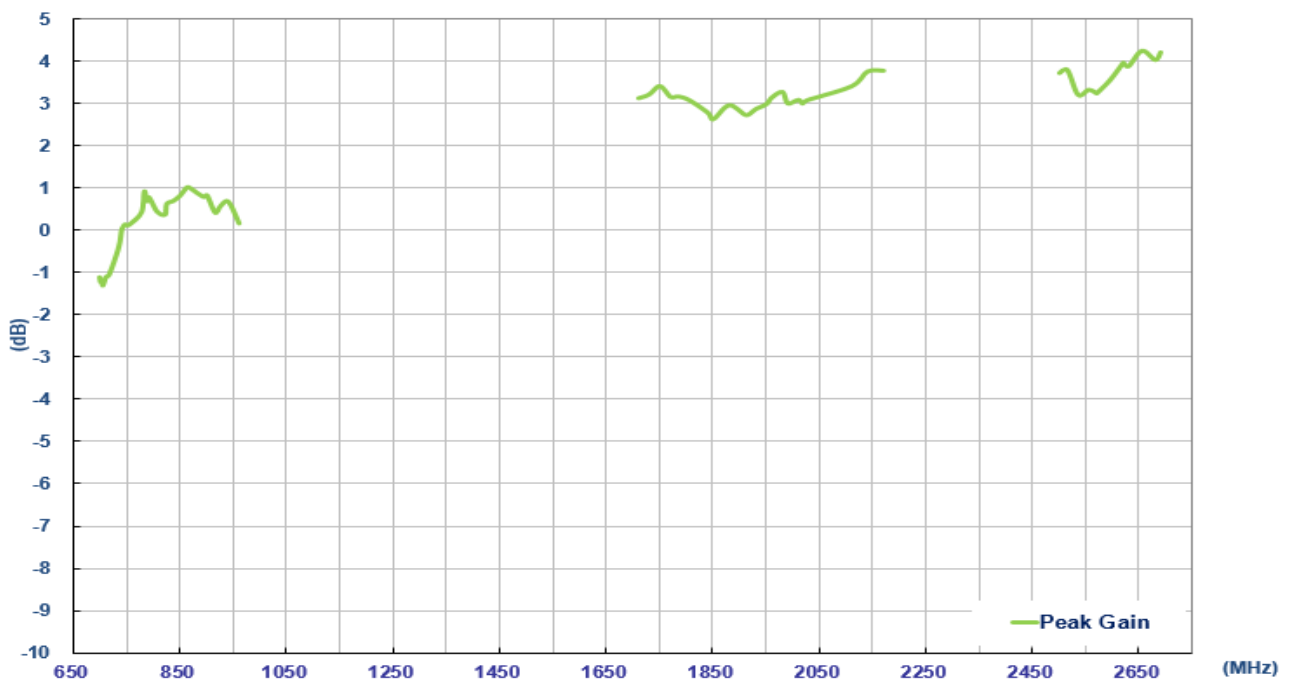

4. Radiation Patterns

4.1 Test Setup

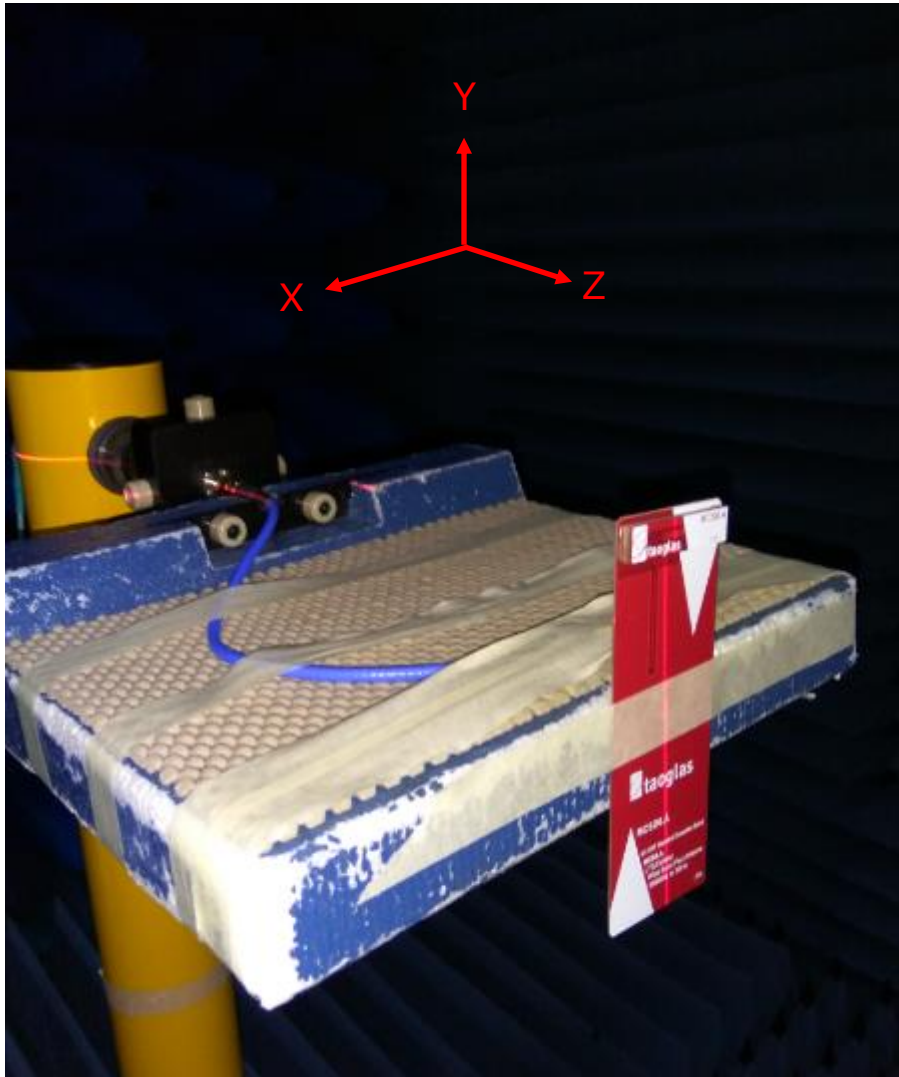

Free space

4.2 2D & 3D Radiation Patterns

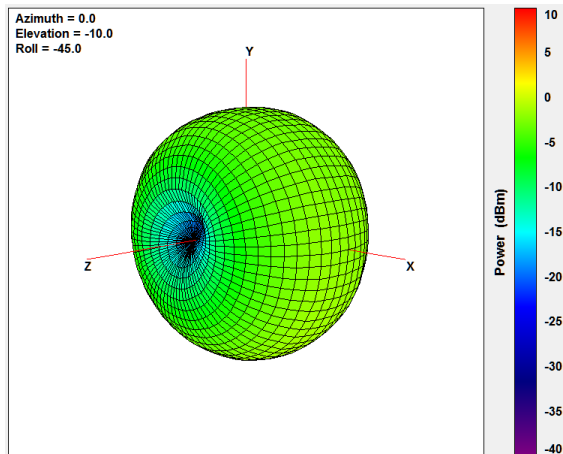

698MHz

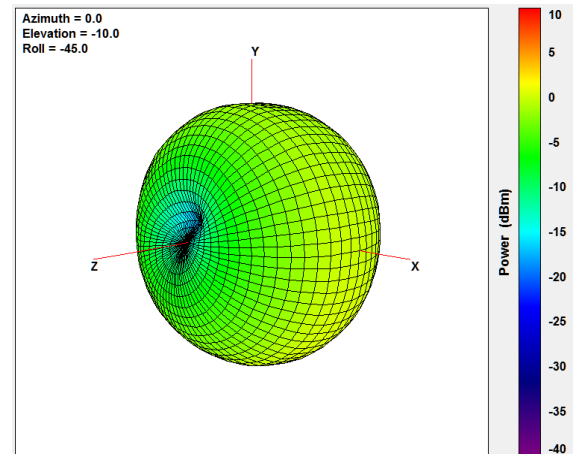

824MHz

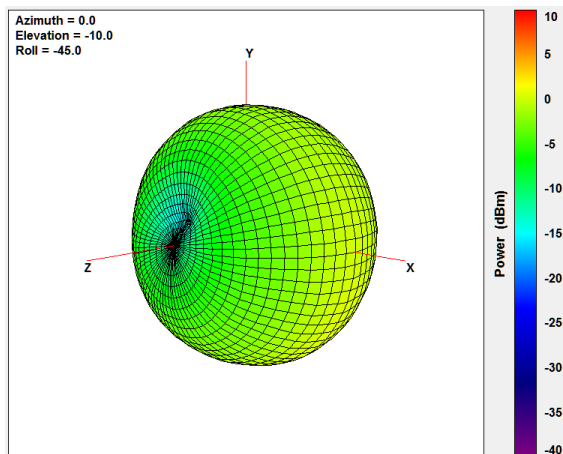

894MHz

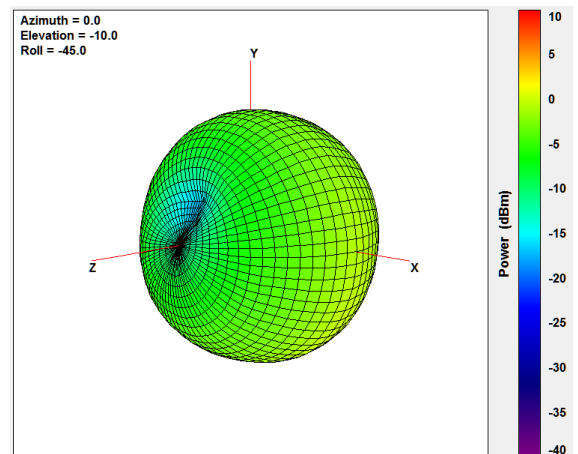

960MHz

XY Plane

XZ Plane

YZ Plane

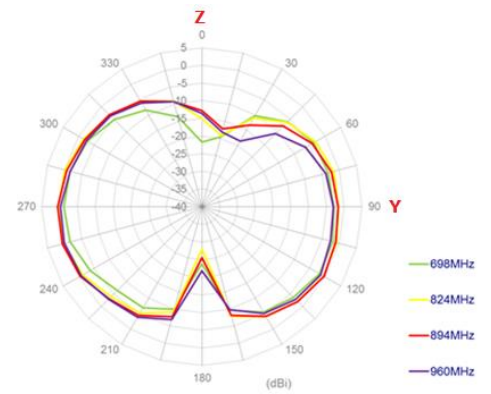
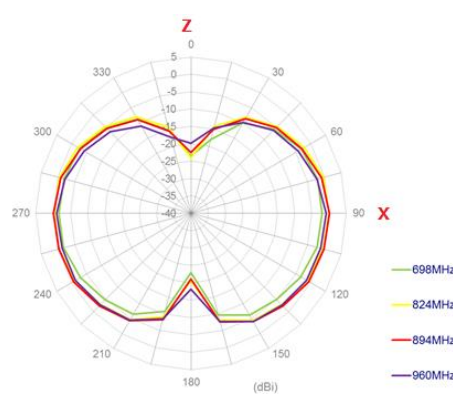
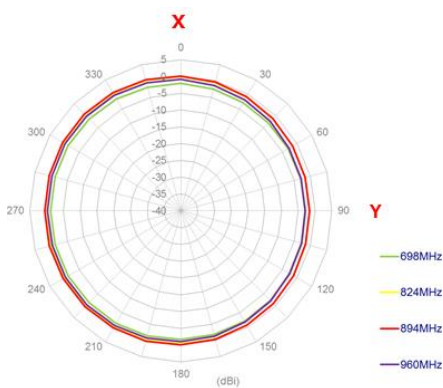

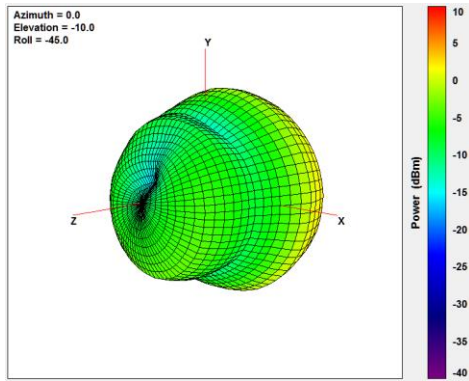

1710MHz

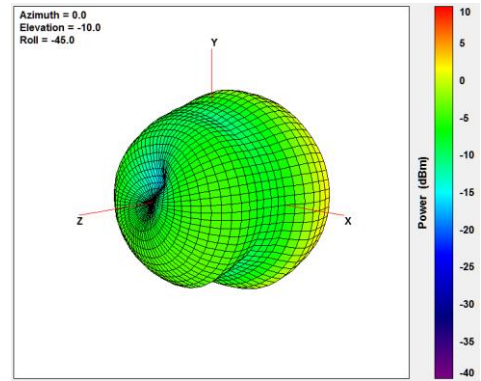

1805MHz

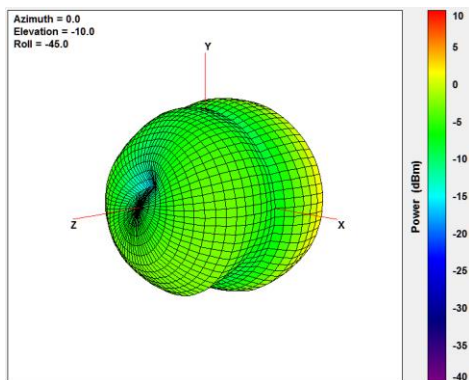

1910MHz

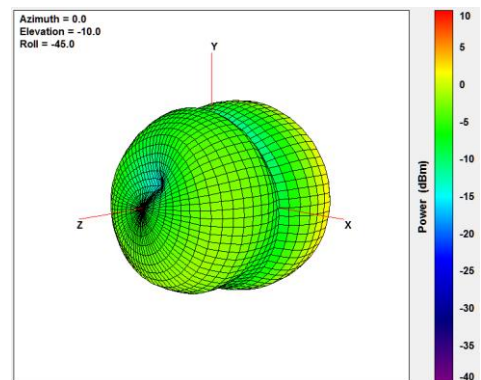

1990MHz

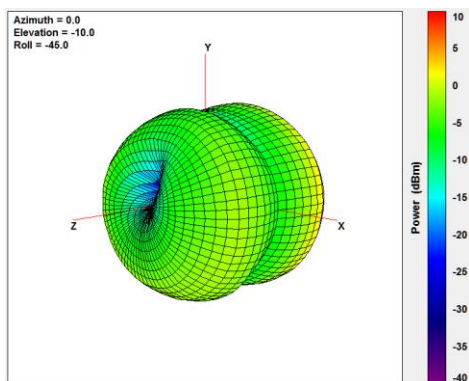

2170MHz

XY Plane | XZ Plane | YZ Plane

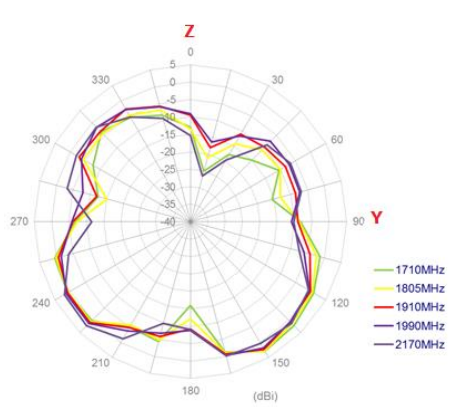
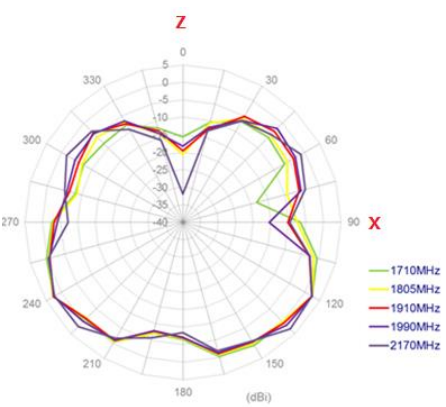
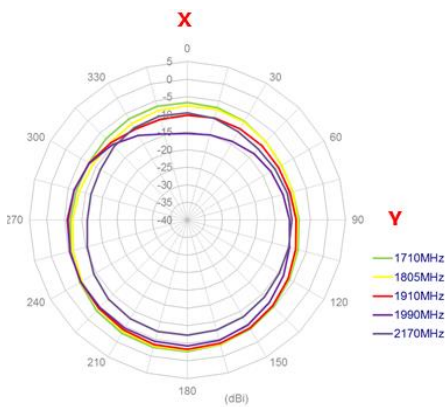

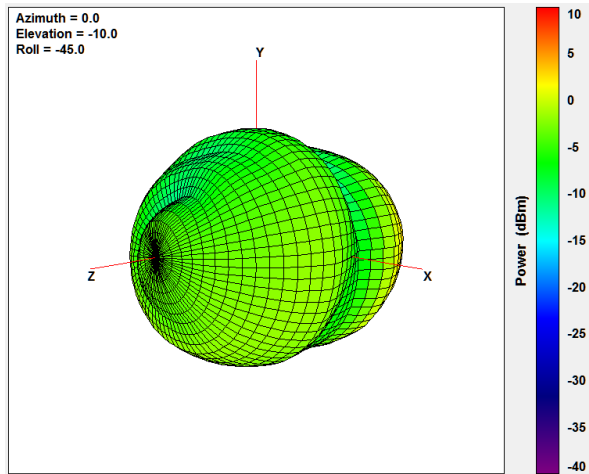

2500MHz

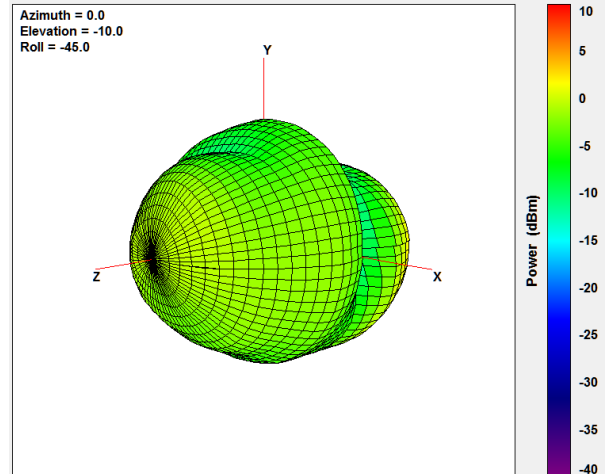

2620MHz

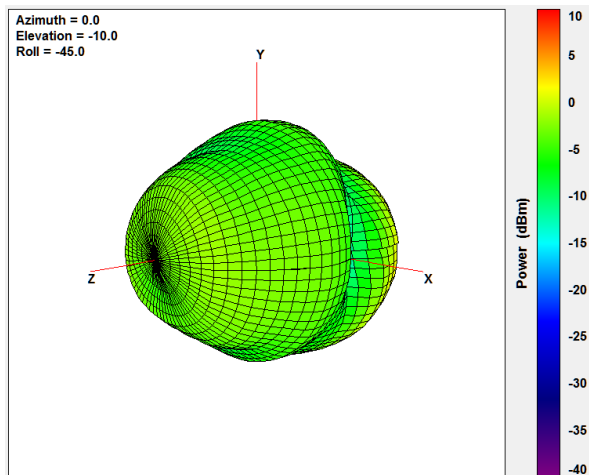

2690MHz

XY Plane XZ Plane YZ Plane

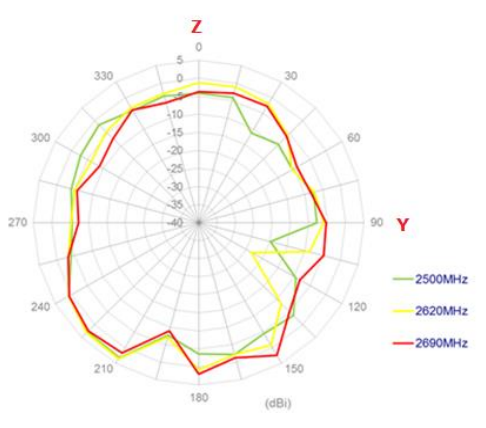
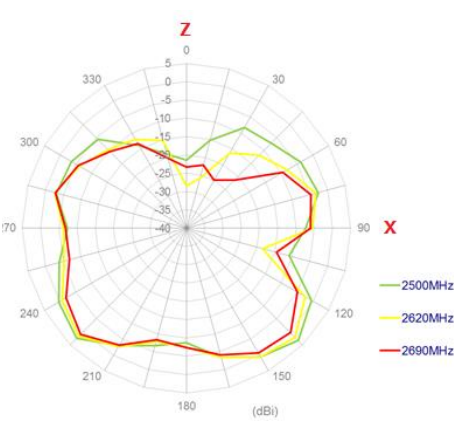
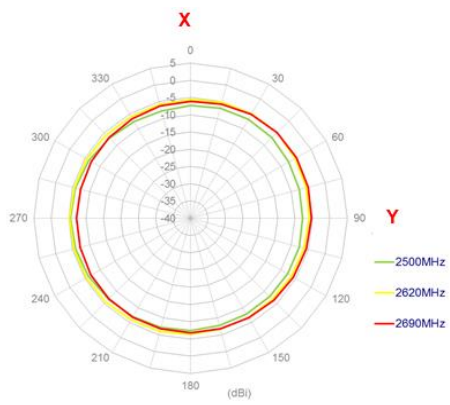

5. Matching Circuits

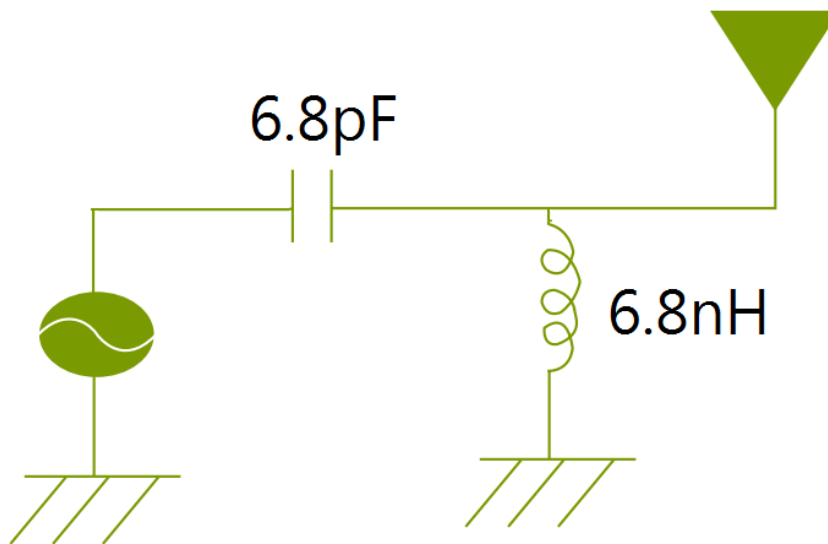

6. Mechanical Drawing

6.1 Mechanical Drawing

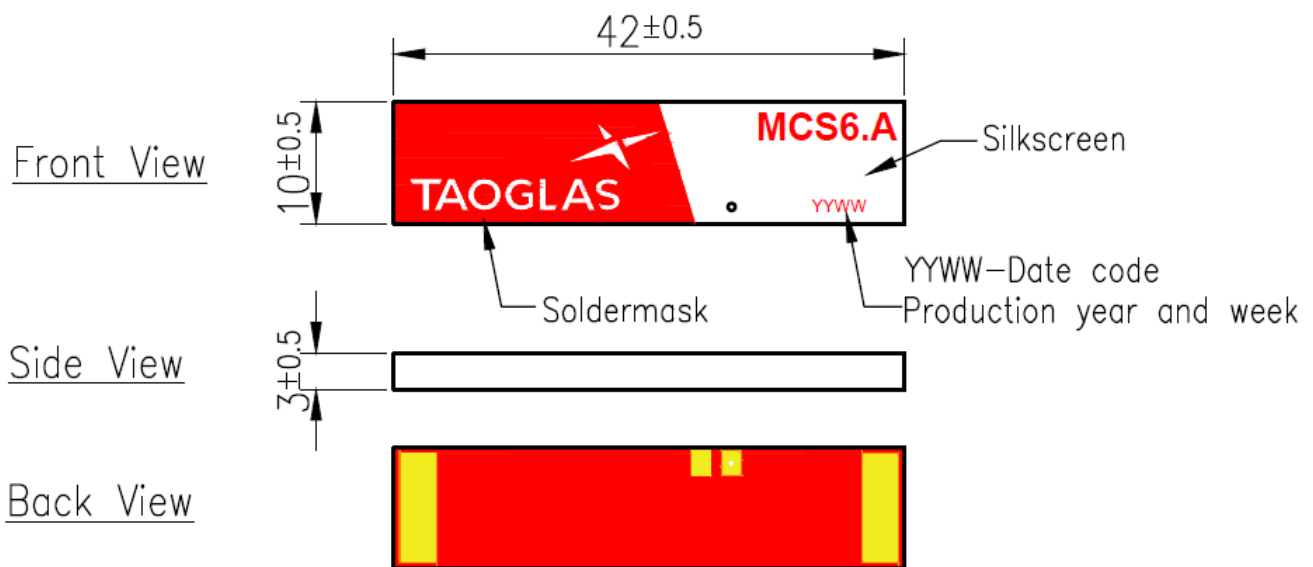

6.2 Footprint

FootPrint

Top Copper

Pads 1 and 2 are the same size, Pads 3 and 4 are the same size, Pad 4 should be connected to a 50 ohm transmission line.

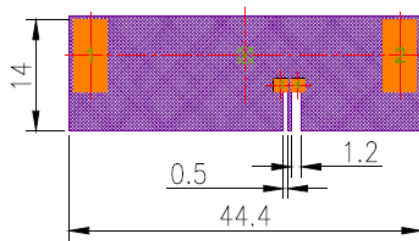

B

Pin/Pad Number	Value
1	NC (No connect / Open)
2	NC (No connect / Open)
3	Ground
4	Feed Line

Top Solder Paste

Pads 1 and 2 are the same size, Pads 3 and 4 are the same size.

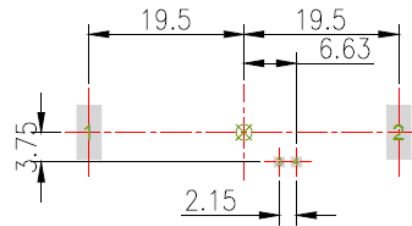

Top Solder Mask

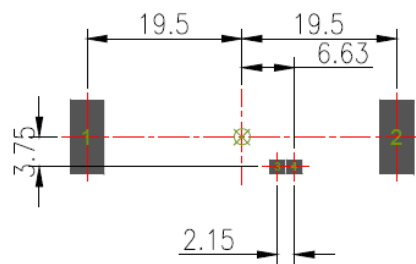

Composite Diagram

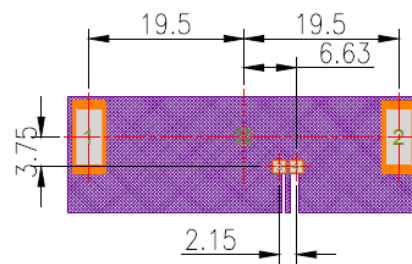

NOTE:

1. Au Plated area
2. Solder Mask area
3. Copper area
4. Paste area
5. Keepout Region area
6. Silkscreen
7. Soldermask



8. Ground keepout should extend through any inner PCB layers and any sides around the antenna till the board edge to minimize coupling from RF feed to ground, except the side facing system ground.
9. Any vias in pads should be either filled or tented to prevent solder from wicking away from the pad during reflow.
10. The dimension tolerances should follow standard PCB manufacturing guidelines.

6.3 Evaluation Board

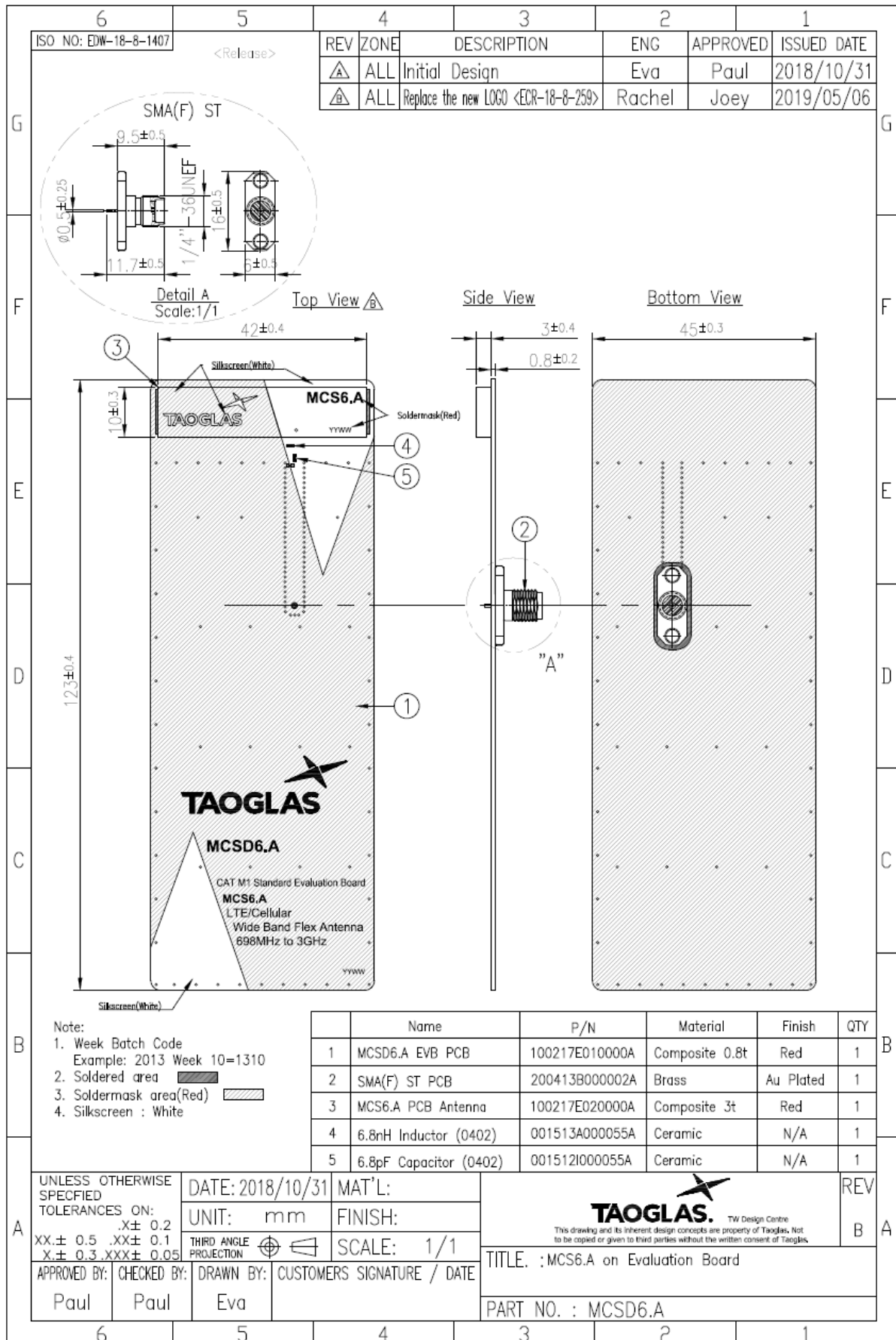

7. Packaging

1000 pcs MCS6.A reel
 Dimensions - 330*330*60mm
 Weight - 2kg

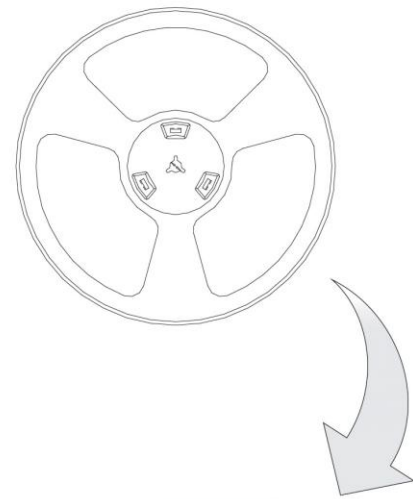

1000 pcs MCS6.A / 1 Reel in small box
 Dimensions - 335*340*90mm
 Weight - 2.1Kg

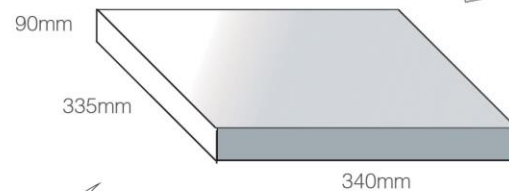

4 reels, 4000 pcs in one carton
 Carton Dimensions - 370*360*370mm
 Weight - 9.2Kg

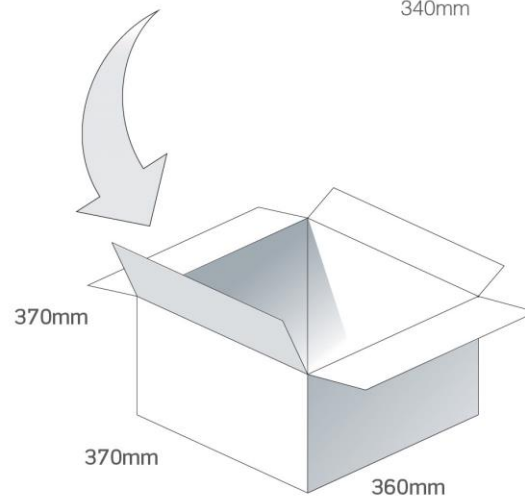

Pallet Dimensions 1200*1000*1310mm
 18 Cartons per Pallet
 6 Cartons per layer
 3 Layers

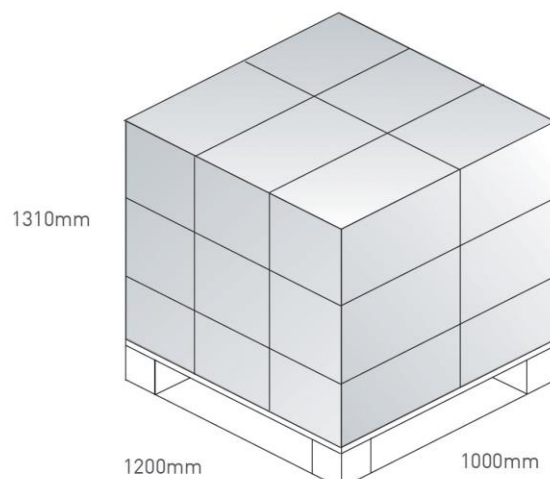

8. Application Note

8.1 Return Loss

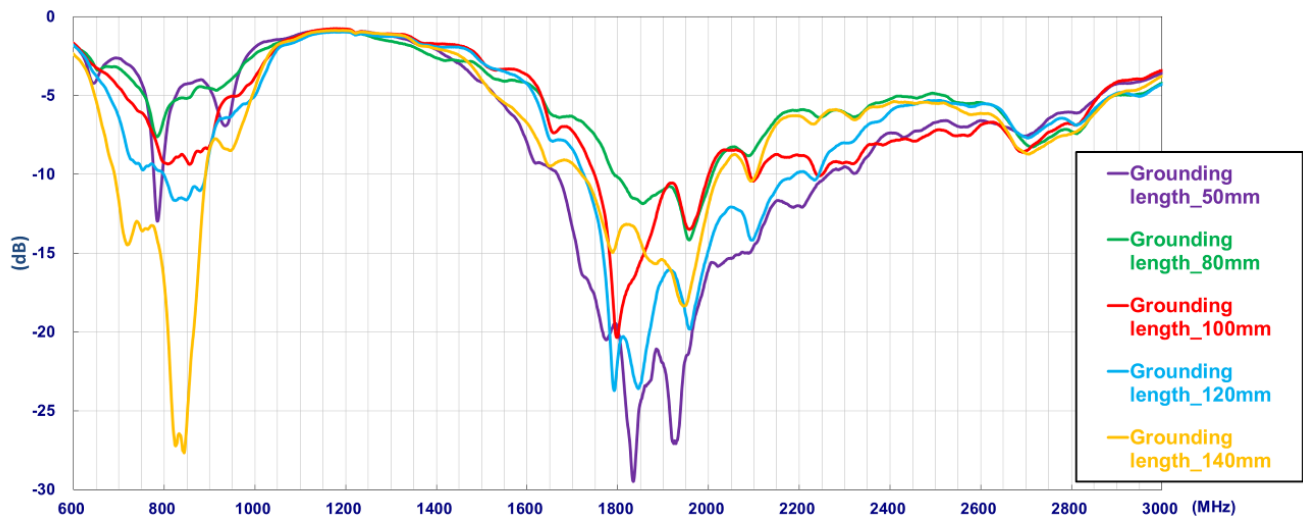

8.2 Efficiency

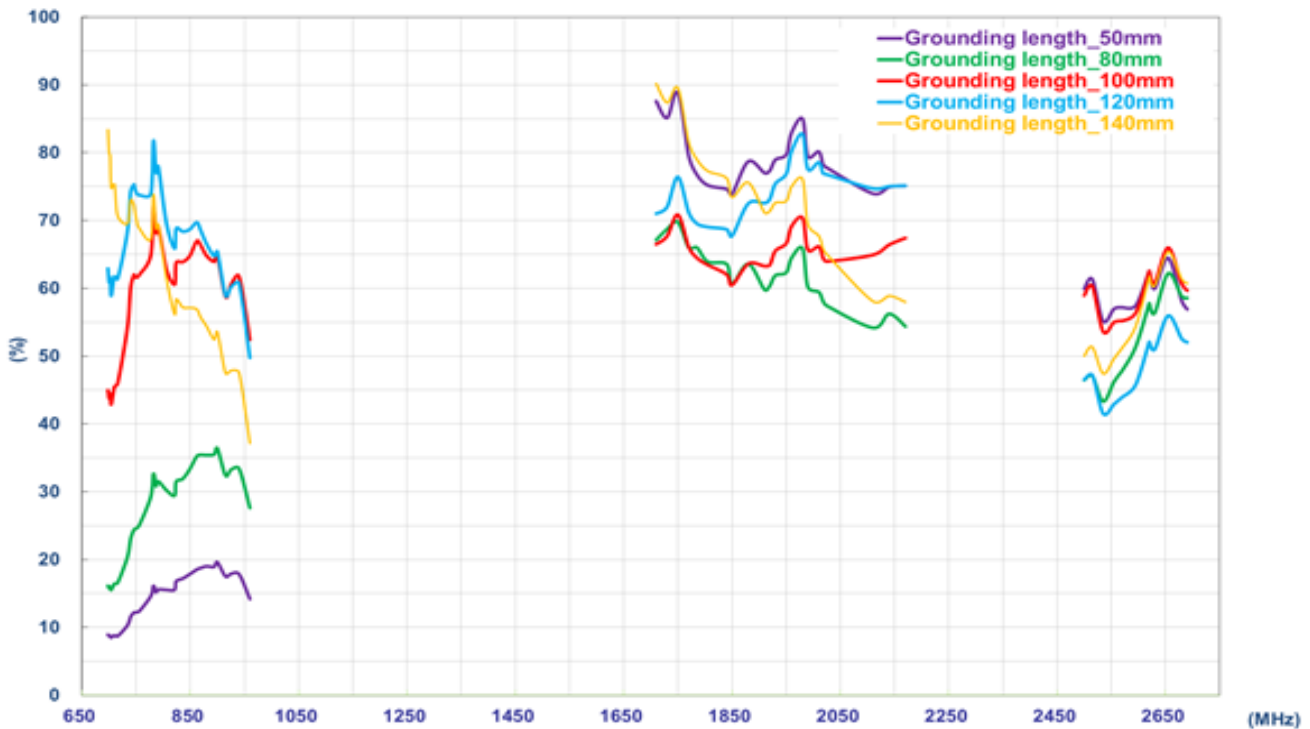

8.3 Peak Gain

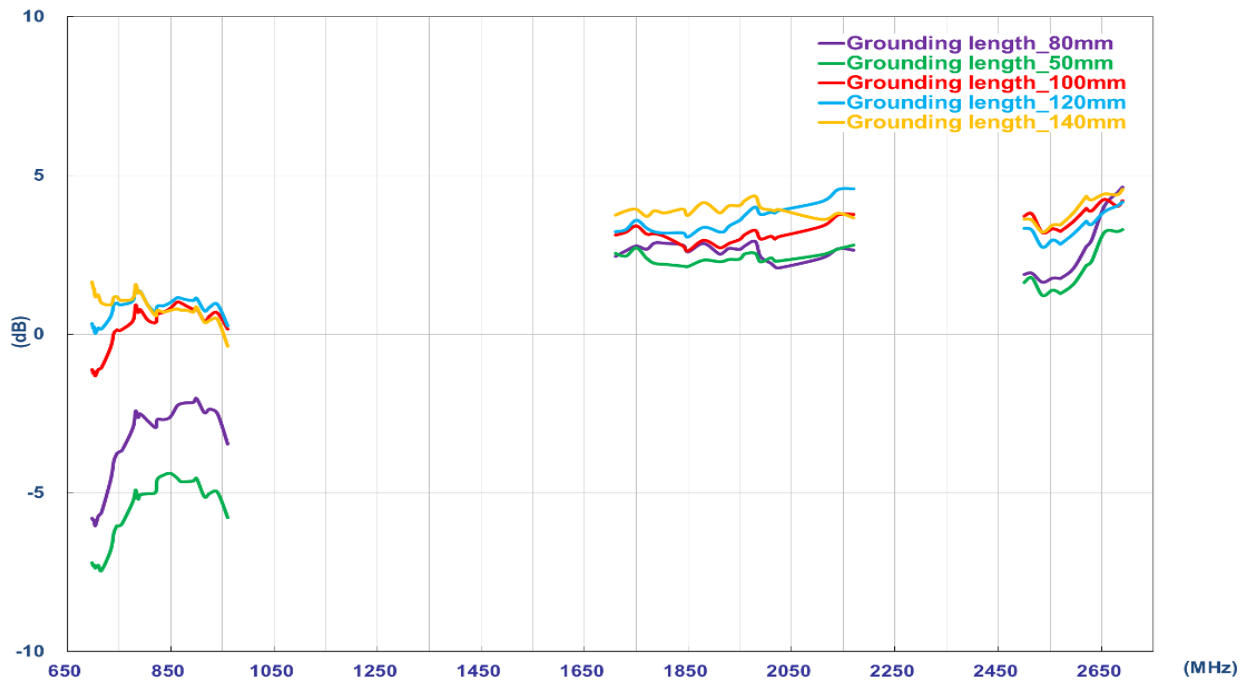

8.4 Average Gain

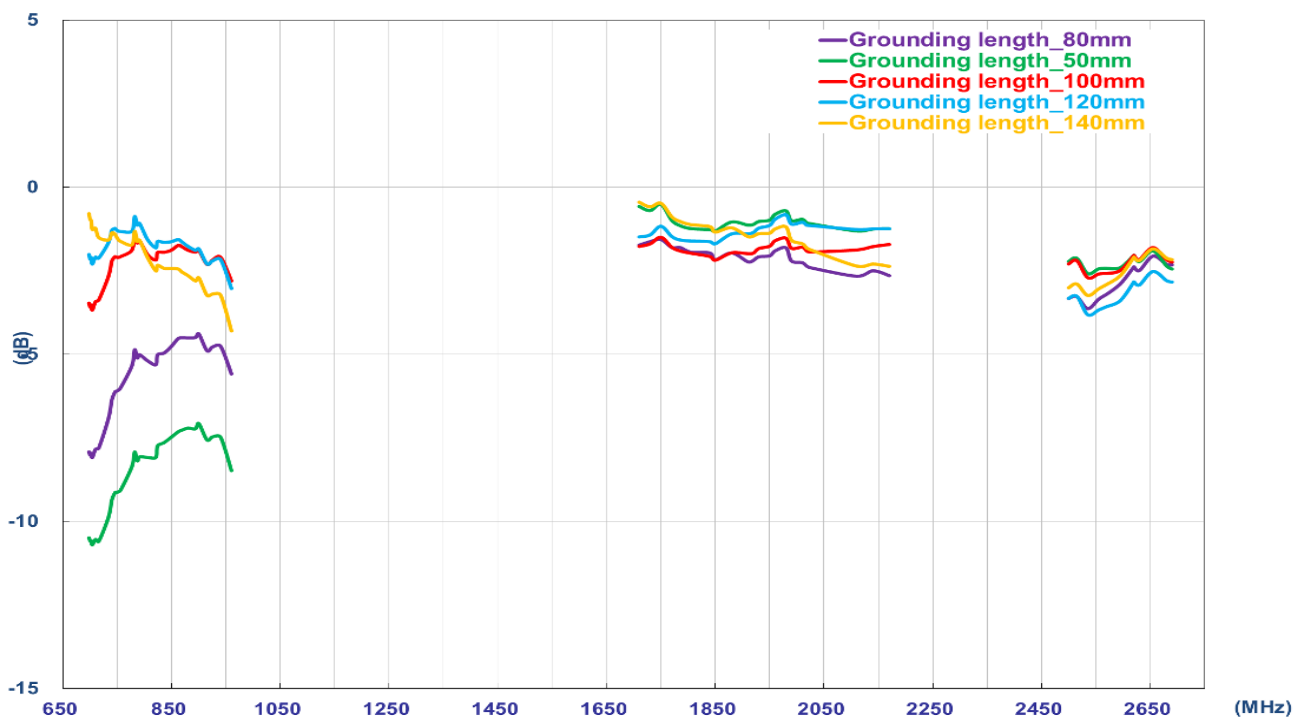

Changelog for the datasheet

SPE-17-8-036 – MCS6.A

Revision: D (Current Version)

Date:	2019-07-25
Changes:	Template & EVB Drawing
Changes Made by:	Jack Conroy

Previous Revisions

Revision: C

Date:	2018-10-23
Changes:	Pads Amended
Changes Made by:	David Connolly

Revision: B

Date:	2017-08-08
Changes:	Drawing Updated
Changes Made by:	Andy Mahoney

Revision: A (Original First Release)

Date:	2017-08-10
Notes:	
Author:	Jack Conroy



TAOGLAS®

www.taoglas.com

