

# HCM1305

## High current power inductors

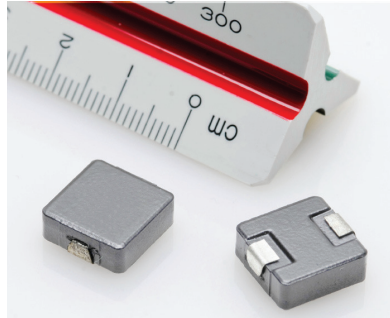

### Product features

- High current carrying capacity
- Low core losses
- Magnetically shielded, low EMI
- Frequency range up to 5 MHz
- Inductance range from 0.10  $\mu$ H to 33  $\mu$ H
- Current range from 5.2 A to 118 A
- 13.8 mm x 12.5 mm footprint surface mount package in a 5.0 mm height
- Iron powder core material

### Applications

- Voltage Regulator Module (VRM)
- Multi-phase regulators
- Point-of-load modules
- Desktop and server VRMs and EVRDs
- Base station equipment
- Notebook and laptop regulators
- Battery power systems
- Graphics cards
- Data networking and storage systems

### Environmental data

- Storage temperature range (component): -55 °C to +125 °C
- Operating temperature range: -55 °C to +125 °C (ambient plus self-temperature rise)
- Solder reflow temperature: J-STD-020 (latest revision) compliant



**Product specifications**

Part Number <sup>6</sup>	OCL <sup>1</sup> ( $\mu\text{H}$ ) $\pm$ 20%	FLL <sup>2</sup> Min. ( $\mu\text{H}$ )	$I_{\text{rms}}^3$ (A)	$I_{\text{sat}}^4$ (A)	DCR (m $\Omega$ ) @ +20 °C $\pm$ nominal	DCR (m $\Omega$ ) @ +20 °C maximum	K-factor <sup>5</sup>
HCM1305-R10-R	0.10	0.064	55	118	0.52	0.59	848
HCM1305-R22-R	0.22	0.14	51	110	0.63	0.72	843
HCM1305-R33-R	0.33	0.21	42	80	0.80	0.92	506
HCM1305-R47-R	0.47	0.30	38	65	0.80	0.92	506
HCM1305-R56-R	0.56	0.36	36	55	1.15	1.33	500
HCM1305-R68-R	0.68	0.44	34	54	1.15	1.33	500
HCM1305-R82-R	0.82	0.52	31	53	1.40	1.61	358
HCM1305-1R0-R	1.00	0.64	29	50	2.10	2.42	275
HCM1305-1R5-R	1.50	0.96	23	48	2.75	3.16	225
HCM1305-1R8-R	1.80	1.15	21	40	4.00	4.60	216
HCM1305-2R2-R	2.20	1.41	20	32	4.60	5.29	191
HCM1305-3R3-R	3.30	2.11	15	32	7.70	9.20	170
HCM1305-4R7-R	4.70	3.01	12	27	11.0	12.7	161
HCM1305-5R6-R	5.60	3.58	11.5	22	12.0	13.8	142
HCM1305-6R8-R	6.80	4.35	11	21	13.0	15.0	129
HCM1305-7R8-R	7.80	4.99	10	18.5	16.8	19.4	117
HCM1305-8R2-R	8.20	5.25	9.5	18	17.5	20.1	117
HCM1305-100-R	10.0	6.40	9.0	16	19.0	21.9	90
HCM1305-150-R	15.0	9.60	7.7	13	29.0	33.4	74
HCM1305-220-R	22.0	14.1	6.2	10	45.0	51.8	63
HCM1305-330-R	33.0	21.1	5.2	8	74.5	85.5	48

1. Open Circuit Inductance (OCL) Test Parameters: 100 kHz, 0.25  $V_{\text{rms}}$ , 0.0 Adc, +25 °C.
2. Full Load Inductance (FLL) Test Parameters: 100 kHz, 0.25  $V_{\text{rms}}$ ,  $I_{\text{sat}}$  @ +25 °C.
3.  $I_{\text{rms}}$ : DC current for an approximate temperature rise of 40 °C without core loss. Derating is necessary for AC currents. PCB layout, trace thickness and width, air-flow, and proximity of other heat generating components will affect the temperature rise. It is recommended that the temperature of the part not exceed +125 °C under worst case operating conditions verified in the end application.

4.  $I_{\text{sat}}$ : Peak current for approximately 20% rolloff at +25 °C.
5. K-factor: Used to determine  $B_{\text{pp}}$  for core loss (see graph).  $B_{\text{pp}} = K * L * \Delta I$ .  
 $B_{\text{pp}}$ : (Gauss), K: (K-factor from table), L: (Inductance in  $\mu\text{H}$ ),  $\Delta I$  (Peak to peak ripple current in amps).
6. Part Number Definition: HCM1305-yyy-R  
- HCM1305 = Product code and size  
yyy= Inductance value in  $\mu\text{H}$ , R = decimal point,  
if no R is present then third character = number of zeros.  
“-R” suffix = RoHS compliant

**Dimensions- mm**

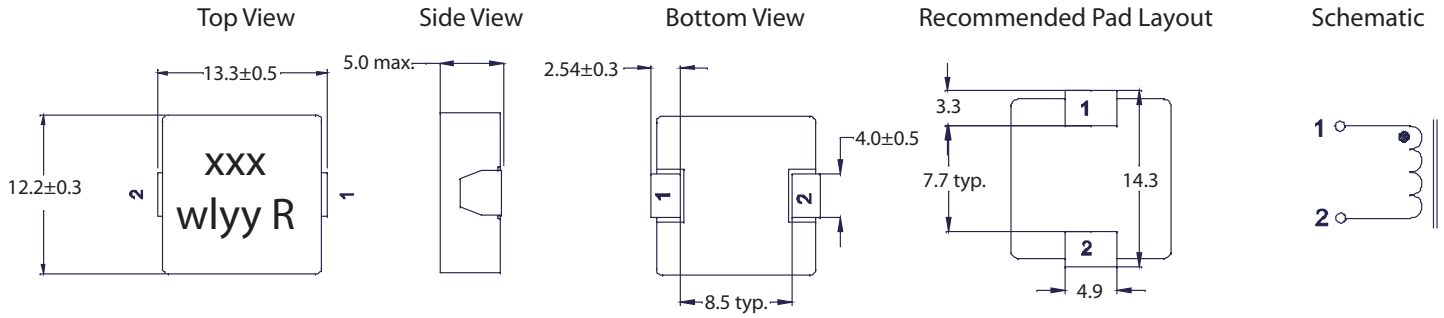

Part Marking: xxx = Inductance value in  $\mu\text{H}$ , R = decimal point, if no R is present, third character = number of zeros, wlyy = (Date Code), R = (Revision Level)

All soldering surfaces to be coplanar within 0.10 millimeters.

Tolerances are  $\pm 0.3$  millimeters unless stated otherwise.

Color: Grey.

Do not route traces or vias underneath the inductor

**Packaging information - mm**

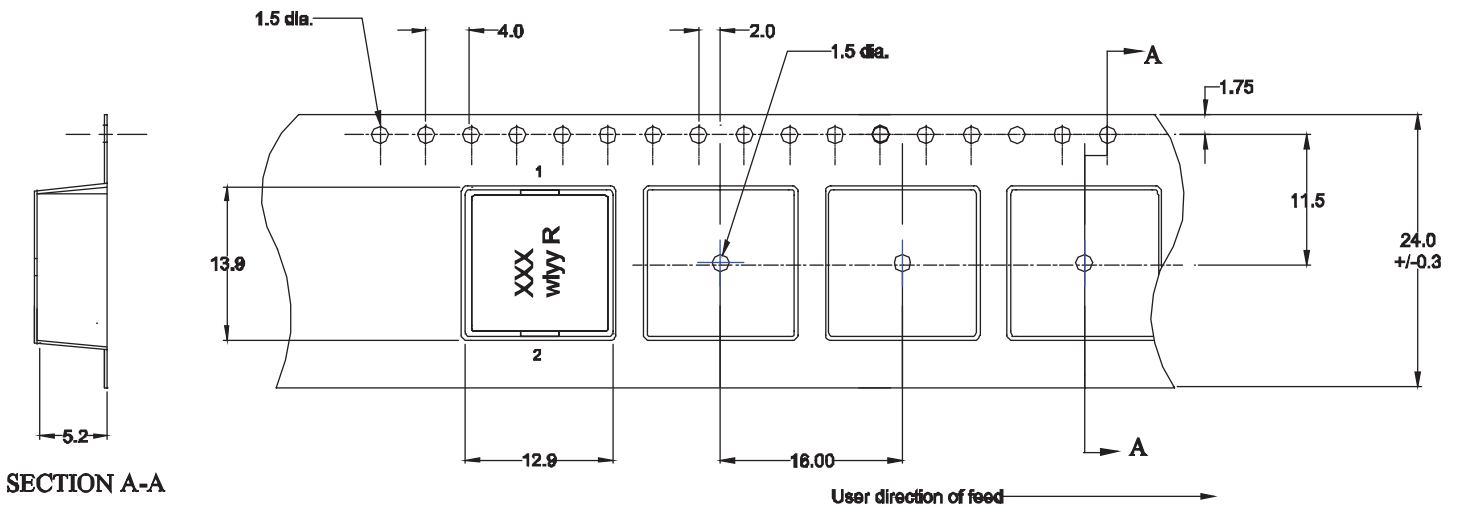

Supplied in tape and reel packaging, 400 parts per 13" diameter reel.

**Temperature rise vs. total loss**

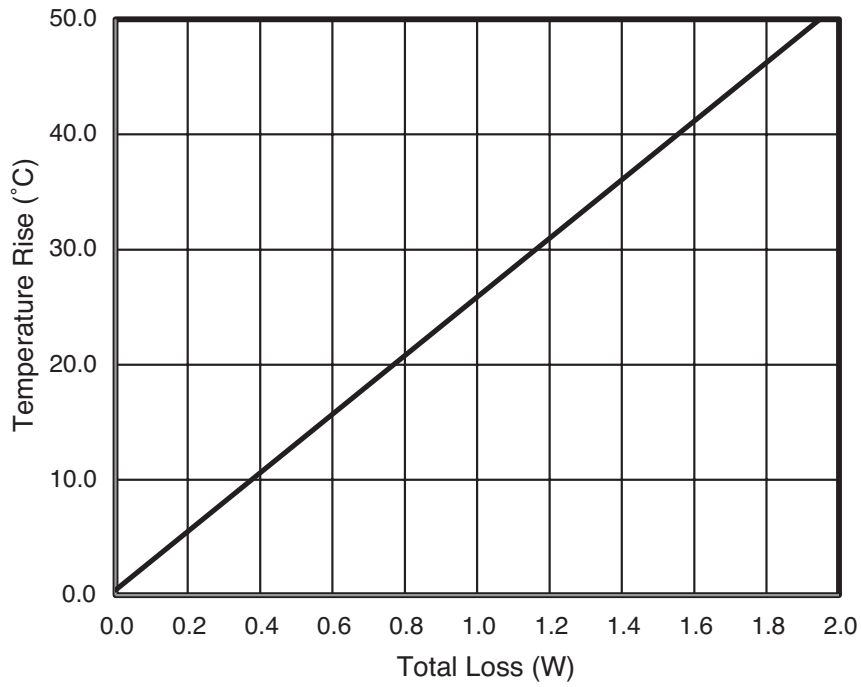

**Core loss vs. B<sub>p-p</sub>**

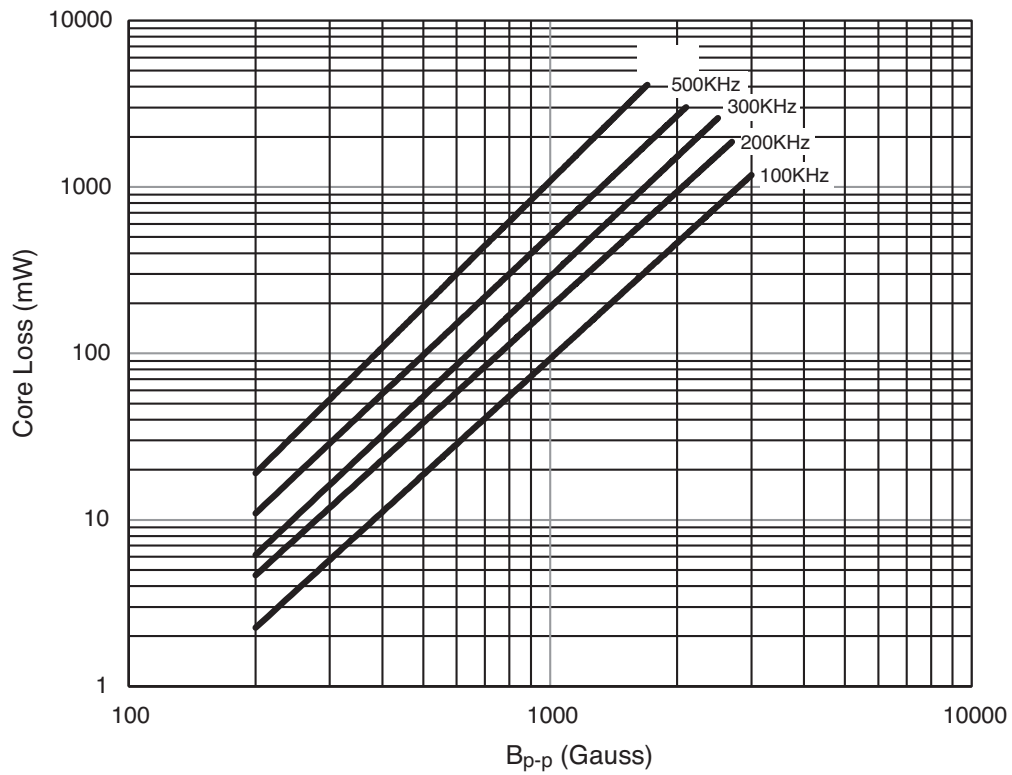

Inductance characteristics

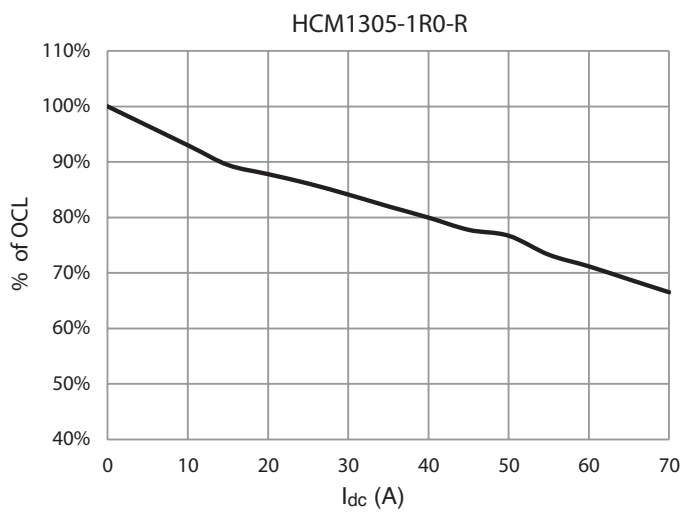
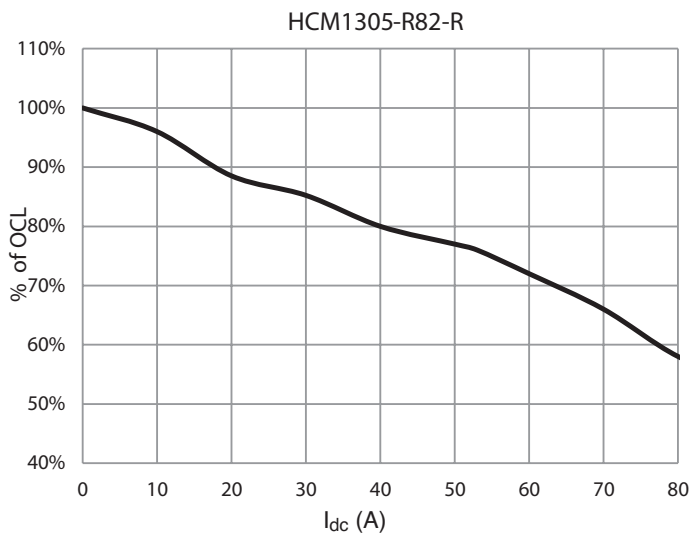
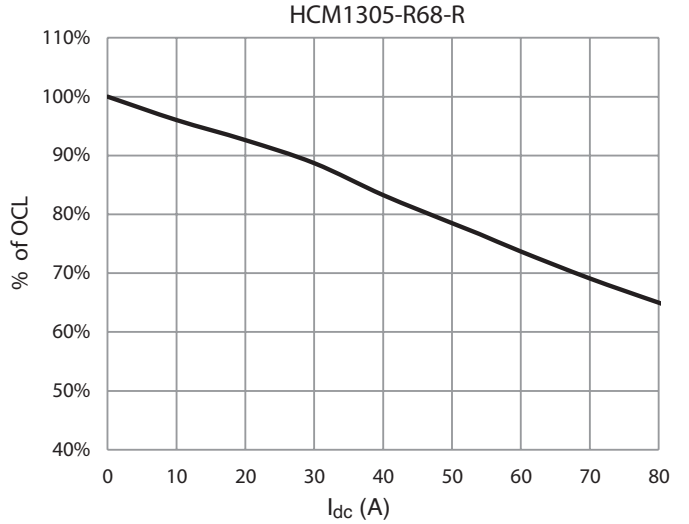
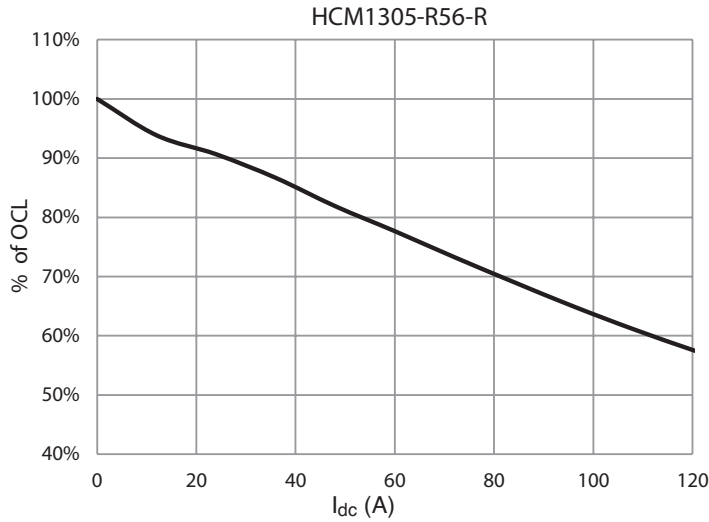
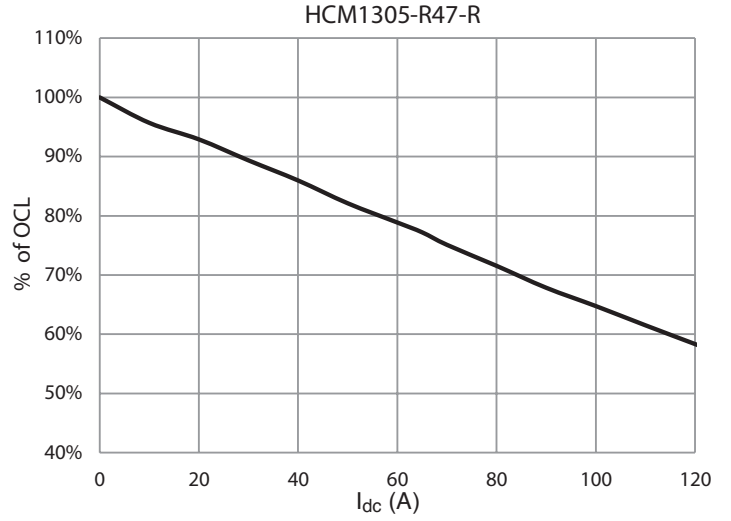
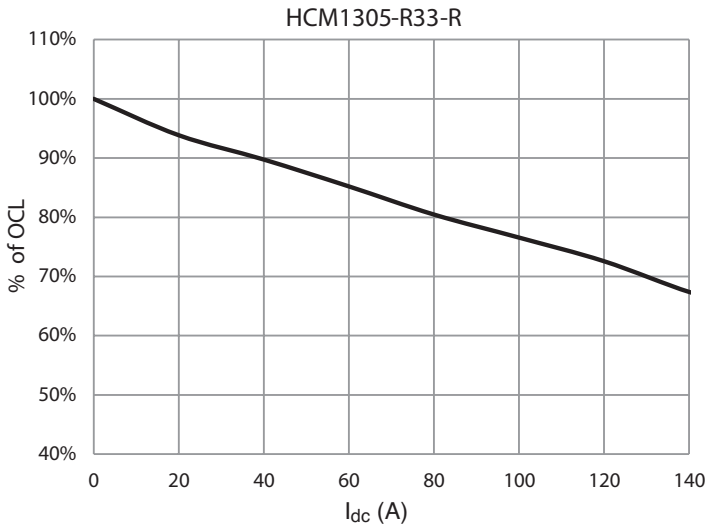

**Inductance characteristics**

HCM1305-1R5-R

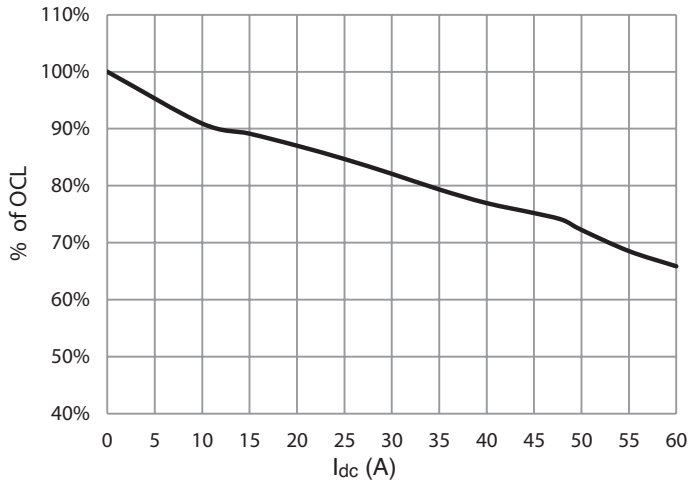

HCM1305-1R8-R

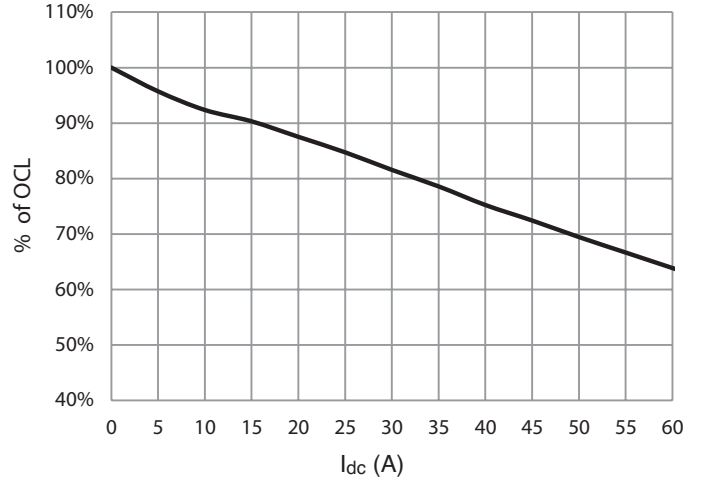

HCM1305-2R2-R

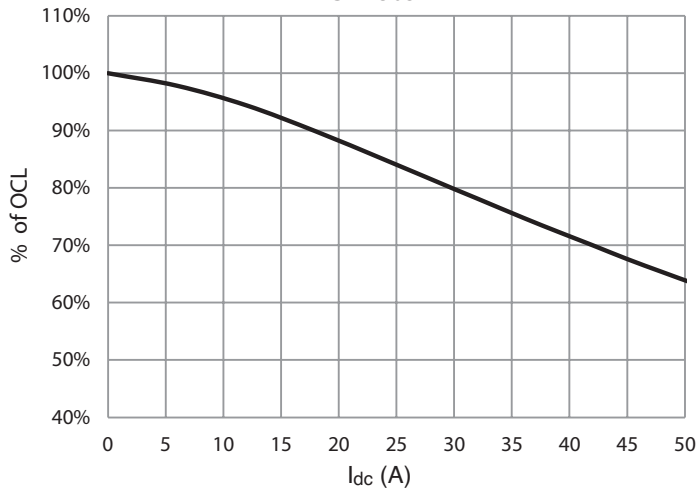

HCM1305-3R3-R

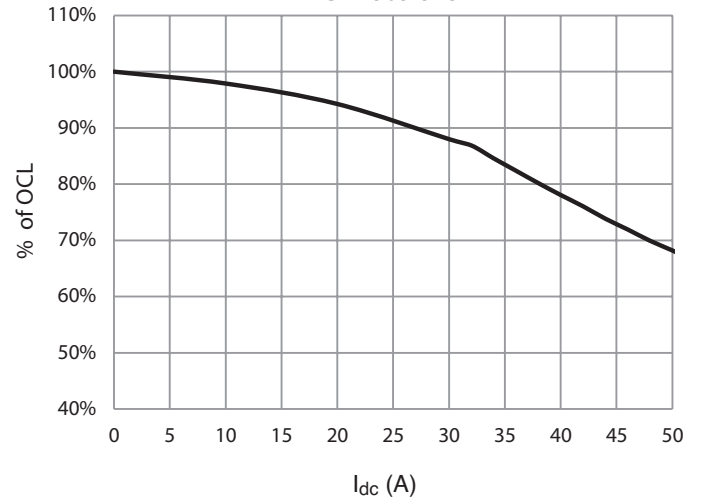

HCM1305-4R7-R

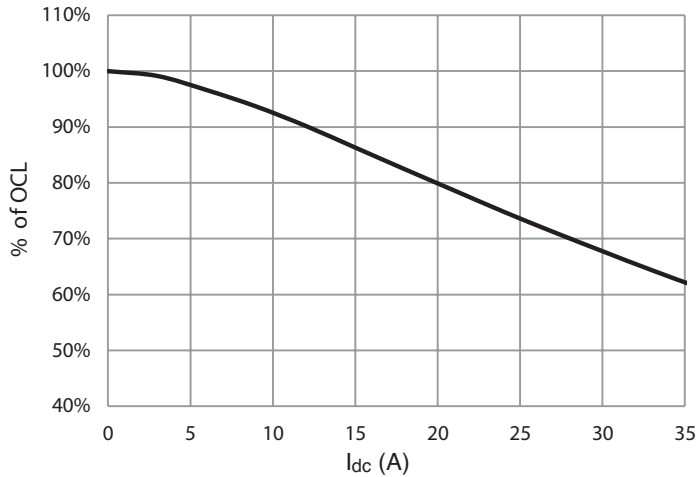

HCM1305-5R6-R

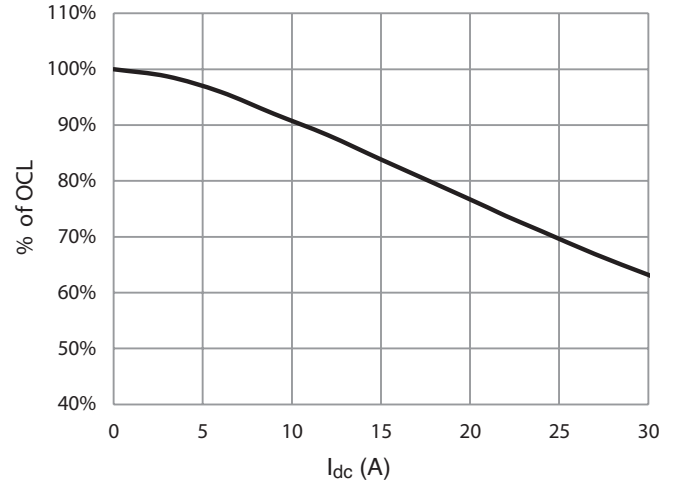

Inductance characteristics

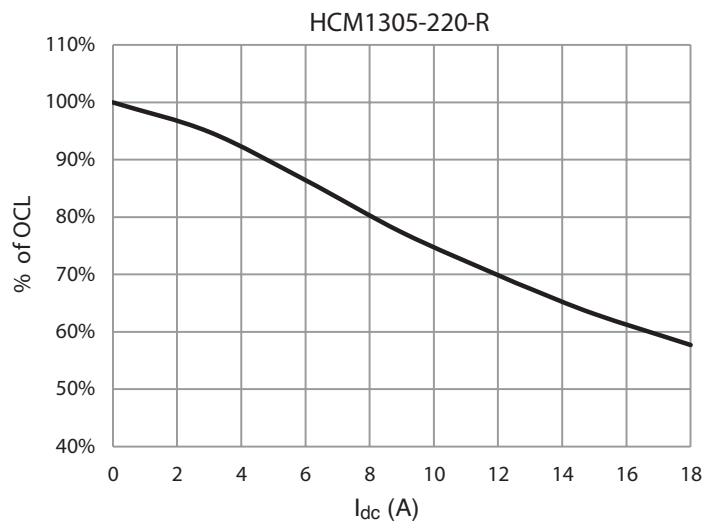
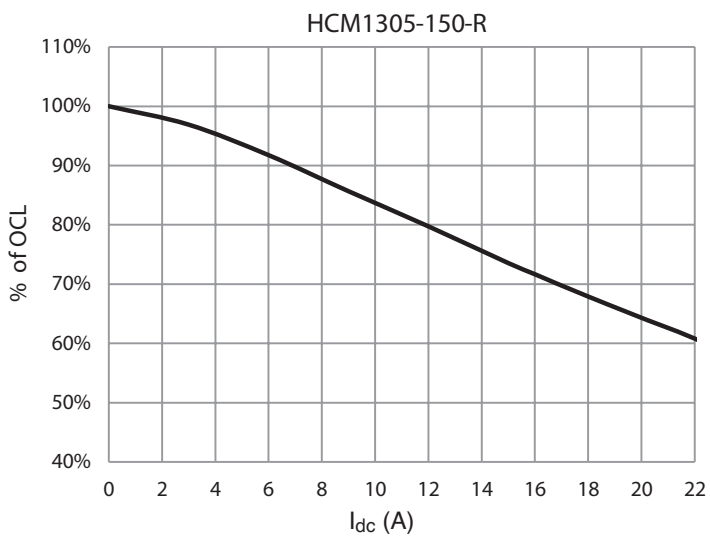
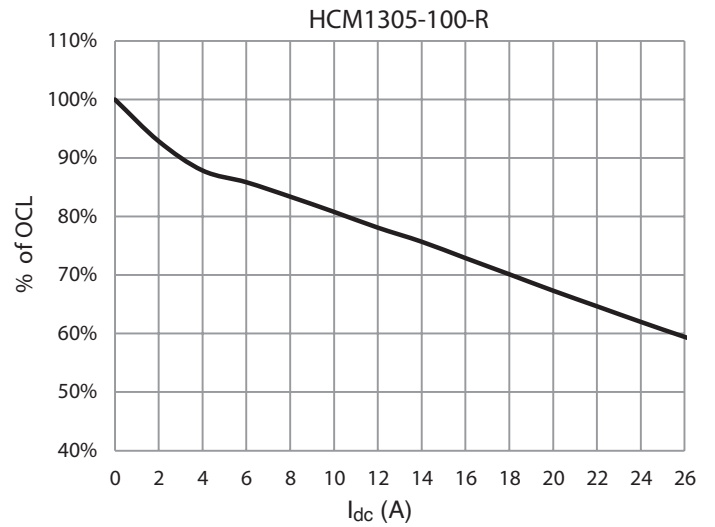
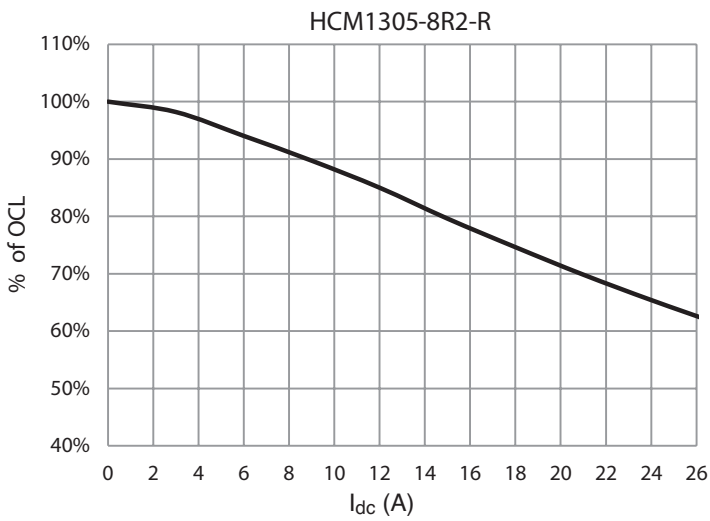
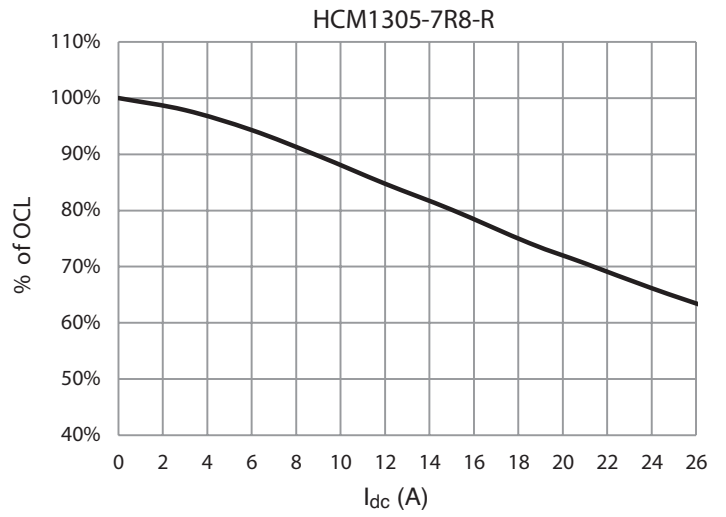
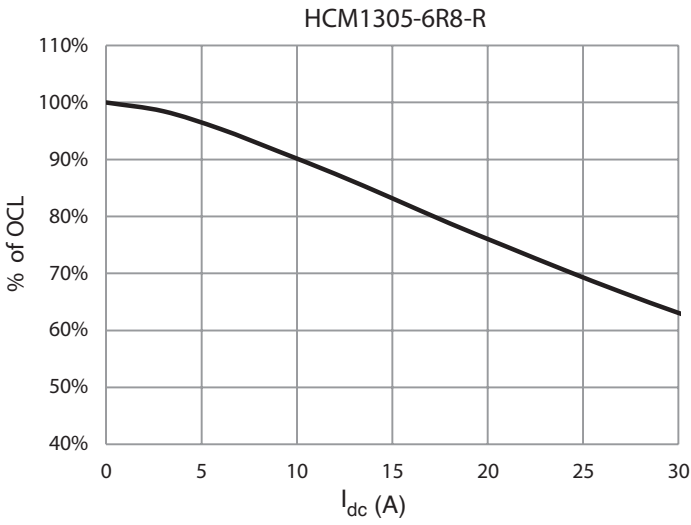

**Inductance characteristics**

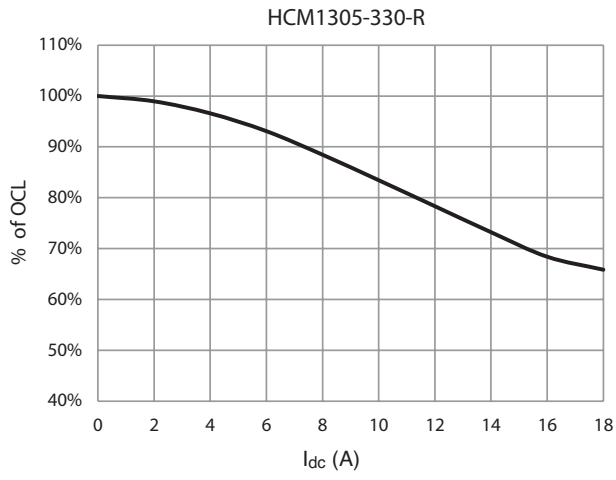



### Solder Reflow Profile

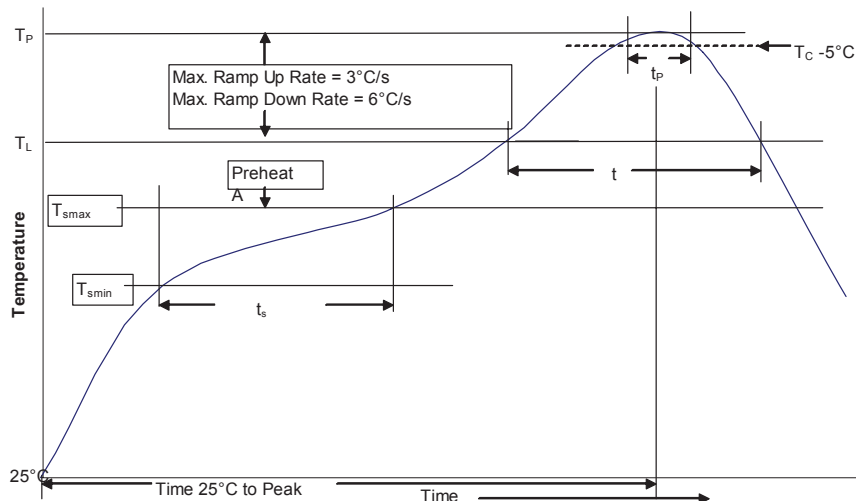

Table 1 - Standard SnPb Solder ( $T_C$ )

Package Thickness	Volume $\text{mm}^3$ <350	Volume $\text{mm}^3$ $\geq 350$
<2.5mm	235°C	220°C
$\geq 2.5\text{mm}$	220°C	220°C

Table 2 - Lead (Pb) Free Solder ( $T_C$ )

Package Thickness	Volume $\text{mm}^3$ <350	Volume $\text{mm}^3$ 350 - 2000	Volume $\text{mm}^3$ >2000
<1.6mm	260°C	260°C	260°C
1.6 - 2.5mm	260°C	250°C	245°C
>2.5mm	250°C	245°C	245°C

### Reference JDEC J-STD-020

Profile Feature	Standard SnPb Solder	Lead (Pb) Free Solder
Preheat and Soak	• Temperature min. ( $T_{smin}$ )	100°C
	• Temperature max. ( $T_{smax}$ )	150°C
	• Time ( $T_{smin}$ to $T_{smax}$ ) ( $t_s$ )	60-120 Seconds
Average ramp up rate $T_{smax}$ to $T_P$	3°C/ Second Max.	3°C/ Second Max.
Liquidous temperature ( $T_L$ )	183°C	217°C
Time at liquidous ( $t_L$ )	60-150 Seconds	60-150 Seconds
Peak package body temperature ( $T_P$ )*	Table 1	Table 2
Time ( $t_p$ )** within 5 °C of the specified classification temperature ( $T_C$ )	20 Seconds**	30 Seconds**
Average ramp-down rate ( $T_P$ to $T_{smax}$ )	6°C/ Second Max.	6°C/ Second Max.
Time 25°C to Peak Temperature	6 Minutes Max.	8 Minutes Max.

\* Tolerance for peak profile temperature ( $T_P$ ) is defined as a supplier minimum and a user maximum.

\*\* Tolerance for time at peak profile temperature ( $t_p$ ) is defined as a supplier minimum and a user maximum.

Life Support Policy: Eaton does not authorize the use of any of its products for use in life support devices or systems without the express written approval of an officer of the Company. Life support systems are devices which support or sustain life, and whose failure to perform, when properly used in accordance with instructions for use provided in the labeling, can be reasonably expected to result in significant injury to the user.

Eaton reserves the right, without notice, to change design or construction of any products and to discontinue or limit distribution of any products. Eaton also reserves the right to change or update, without notice, any technical information contained in this bulletin.

**Eaton**  
Electronics Division  
1000 Eaton Boulevard  
Cleveland, OH 44122  
United States  
www.eaton.com/electronics

© 2017 Eaton  
All Rights Reserved  
Printed in USA  
Publication No. 4371 BU-SB14459  
September 2017