

Subject to changes. Please also observe the further product documentation!

WAGO GmbH & Co. KG
Hansastr. 27
32423 Minden
Phone: +49571 887-0 | Fax: +49571 887-169
Email: info.de@wago.com | Web: www.wago.com

Do you have any questions about our products?
We are always happy to take your call at +49 (571) 887-44222.

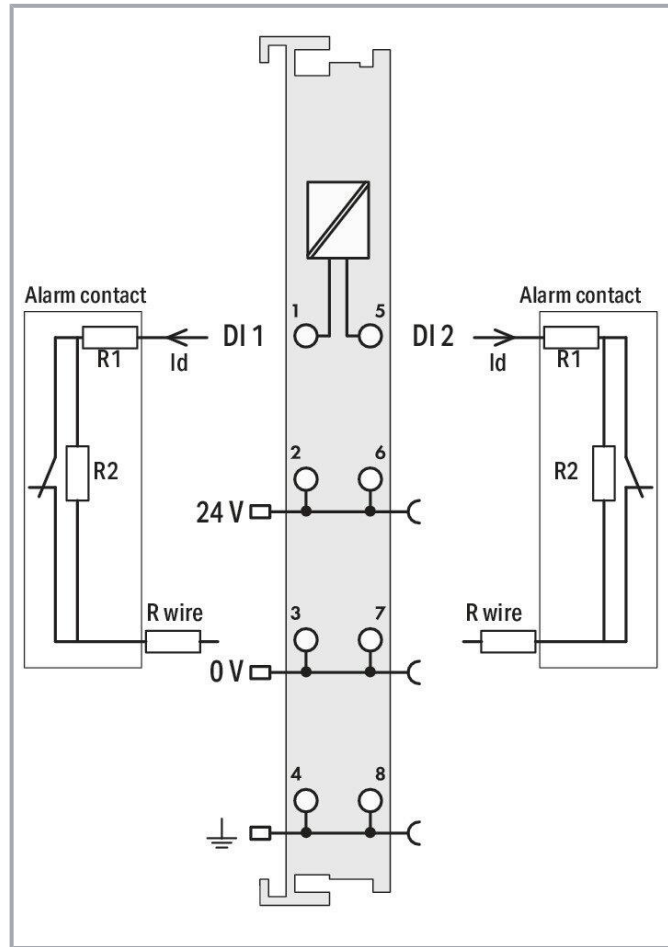
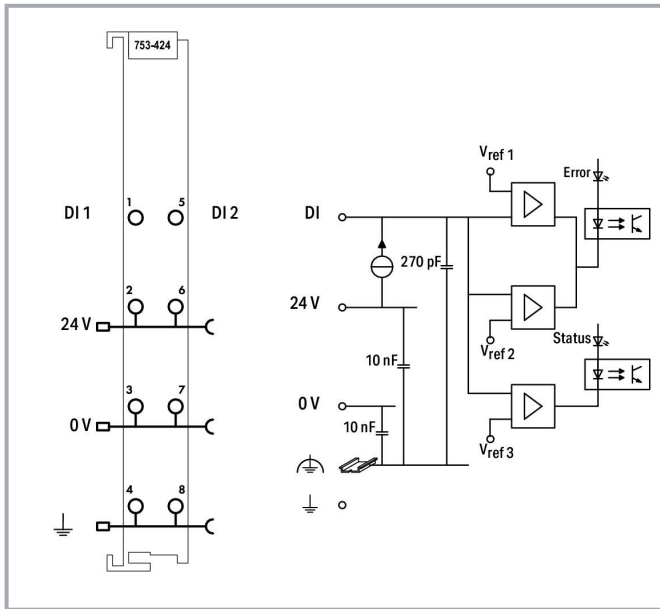

Item description

This module incorporates a current loop, which makes it possible to monitor alarm contacts (window contacts) with a fixed resistance ratio (R_1 , R_2), for intruder detection.

The module indicates the status of the connected contact via LEDs and status bits in the process image.

Data

Notes

Note

Pluggable connectors and coding fingers (753 Series) are not included.

Subject to changes. Please also observe the further product documentation!



Technical data

Number of digital inputs	2
Total number of channels (module)	2
Signal type	Current loop (intruder detection)
Supply voltage (sensor)	24 VDC
Sensor connection	2 x (2-wire)
Specific sensor properties	Alarm contact: R1 = 1.5 k Ω (± 5 %); R2 = 2.2 k Ω (± 5 %); Conductor resistance (R wire): 200 Ω (max.)
Output current per channel	0.001 A
Input data width (internal) max.	4 bits
Data width	4-bit input: 2-bit data, 2-bit error (short circuit/wire break)
Supply voltage (system)	5 VDC; via data contacts
Current consumption (5 V system supply)	6 mA
Supply voltage (field)	24 VDC (-25 ... +30 %); via power jumper contacts (power supply via blade contact; transmission via spring contact)
Current consumption, field supply (module with no external load)	16 mA
Isolation	500 V system/field
Indicators	LED (A, C) green: Status DI 1, DI 2; LED (B, D) red: Error DI 1, DI 2
Number of incoming power jumper contacts	3
Number of outgoing power jumper contacts	3
Current carrying capacity (power jumper contacts)	10 A

Connection data

Connection technology: inputs/outputs	8 x CAGE CLAMP [®]
Connection type 1	Inputs/Outputs
Solid conductor	0.08 ... 2.5 mm ² / 28 ... 14 AWG
Fine-stranded conductor	0.08 ... 2.5 mm ² / 28 ... 14 AWG
Strip length	9 ... 10 mm / 0.35 ... 0.39 inches

Physical data

Width	12 mm / 0.472 inches
Height	100 mm / 3.937 inches
Depth	69.8 mm / 2.748 inches
Depth from upper-edge of DIN-rail	62.6 mm / 2.465 inches

Subject to changes. Please also observe the further product documentation!

WAGO GmbH & Co. KG
 Hansastr. 27
 32423 Minden
 Phone: +49571 887-0 | Fax: +49571 887-169
 Email: info.de@wago.com | Web: www.wago.com

Do you have any questions about our products?
 We are always happy to take your call at +49 (571) 887-44222.



Mechanical Data

Mounting type	DIN-35 rail
Pluggable connector	Pluggable

Material Data

Color	light gray
Housing material	Polycarbonate; polyamide 6.6
Fire load	1.133 MJ
Weight	40 g
Conformity marking	CE

Environmental requirements

Ambient temperature (operation)	0 ... +55 °C
Ambient temperature (storage)	-25 ... +85 °C
Protection type	IP20
Pollution degree	2 per IEC 61131-2
Operating altitude	0 ... 2000 m / 0 ... 6562 ft
Mounting position	horizontal (standing/lying); vertical
Relative humidity (without condensation)	95 %
Vibration resistance	4g per IEC 60068-2-6
Shock resistance	15g per IEC 60068-2-27
EMC immunity to interference	per EN 61000-6-2, marine applications
EMC emission of interference	per EN 61000-6-4, marine applications
Exposure to pollutants	Per IEC 60068-2-42 and IEC 60068-2-43
Permissible H ₂ S contaminant concentration at a relative humidity 75 %	10 ppm
Permissible SO ₂ contaminant concentration at a relative humidity 75 %	25 ppm

Commercial data

Product Group	15 (I/O System)
eCl@ss 10.0	27-24-26-04
eCl@ss 9.0	27-24-26-04
ETIM 8.0	EC001599
ETIM 7.0	EC001599

Subject to changes. Please also observe the further product documentation!

WAGO GmbH & Co. KG
Hansastr. 27
32423 Minden
Phone: +49571 887-0 | Fax: +49571 887-169
Email: info.de@wago.com | Web: www.wago.com

Do you have any questions about our products?
We are always happy to take your call at +49 (571) 887-44222.



PU (SPU)	1 pcs
Packaging type	box
Country of origin	DE
GTIN	4045454848033
Customs tariff number	85389099990

Environmental Product Compliance

CAS-No.	1303-86-2 1317-36-8 7439-92-1 79-94-7
REACH Candidate List Substance	2,2',6,6'-tetrabromo-4,4'-isopropylidenediphenol Diboron trioxide Lead Lead monoxide
RoHS Compliance Status	Compliant,With Exemption
RoHS Exemption	7(a) 7(c)-I 7(c)-II
SCIP notification number (Austria)	edf02147-7c4e-4573-8e06-9323cd33f5e0
SCIP notification number (Belgium)	8fc49cb0-7bfc-416d-a0c7-28f55c5f4cfd
SCIP notification number (Bulgaria)	42467a4f-fd29-4ffa-8124-67bdf8df4b0d
SCIP notification number (Czech Republic)	86a5c6fa-f239-40d6-a54d-e62b5cb549d5
SCIP notification number (Denmark)	7d292f85-e84b-4fcf-97c7-fbcaf3ffc3a8
SCIP notification number (Finland)	3c654b9e-0026-4a16-9449-249a2e2aa19a
SCIP notification number (France)	c69e56ee-e0fd-4b2b-835b-71c912fbf633
SCIP notification number (Germany)	2bf8285c-8f81-4b4c-ad0f-53da7d87b22e
SCIP notification number (Hungary)	3eae2921-6aed-498b-9f08-ed3eeeb513f8
SCIP notification number (Italy)	d4a4ba29-57f9-4c40-8a59-1af5510bdade
SCIP notification number (Netherlands)	fc695c0d-a3c4-492e-8314-01c96bc88d1d
SCIP notification number (Poland)	58879035-ef18-47fa-80ae-8a03c2c8da46
SCIP notification number (Romania)	78639ef7-78a2-4861-8ad0-35742b772f99
SCIP notification number (Sweden)	b6568103-fe7d-4f27-b513-835fef441c80

Approvals / Certificates

General approvals

Logo	Approval	Additional Approval Text	Certificate name
	CCC CNEX	CNCA-C23-01	2020312310000213 (Ex ec IIC T4 Gc)

Subject to changes. Please also observe the further product documentation!

WAGO GmbH & Co. KG
Hansastr. 27
32423 Minden
Phone: +49571 887-0 | Fax: +49571 887-169
Email: info.de@wago.com | Web: www.wago.com

Do you have any questions about our products?
We are always happy to take your call at +49 (571) 887-44222.



EAC
Brjansker Zertifizierungsstelle

TP TC 020/2011

EAC RU C-DE.AM02.
B.00087/19

8

KC
National Radio Research Agency

Article 58-2, Clause 3

MSIP-REM-W43-
DIM750



UL
Underwriters Laboratories Inc. (ORDINARY
LOCATIONS)





UL 508

E175199 Sec.1

Declarations of conformity and manufacturer's declarations

Logo	Approval	Additional Approval Text	Certificate name
	UK-Declaration of Conformity WAGO GmbH & Co. KG	-	-

Approvals for marine applications

Logo	Approval	Additional Approval Text	Certificate name
	ABS American Bureau of Shipping	-	22-2219060
	BSH Bundesamt fuer Seeschifffahrt und Hydrographie	-	1104
	BV Bureau Veritas S.A.	-	13453/E0 BV
	DNV DNV GL SE	DNV-CG-0339, Aug. 2021	TAA0000194
	KR Korean Register of Shipping	-	KR HMB05880- AC001

Subject to changes. Please also observe the further product documentation!

WAGO GmbH & Co. KG
Hansastr. 27
32423 Minden
Phone: +49571 887-0 | Fax: +49571 887-169
Email: info.de@wago.com | Web: www.wago.com

Do you have any questions about our products?
We are always happy to take your call at +49 (571) 887-44222.



	LR Lloyds Register EMEA	-	LR22180952TA
---	----------------------------	---	--------------



PRS Polski Rejestr Statków	-	TE/2236/880590 /19
-------------------------------	---	-----------------------



RINA RINA Germany GmbH	-	ELE343521XG001
---------------------------	---	----------------

Approvals for hazardous areas

Logo	Approval	Additional Approval Text	Certificate name
	ATEX TUEV Nord Cert GmbH	EN 60079-0	TUEV_14_ATEX_148929_X (II 3 G Ex ec IIC T4 Gc)
	CCC CNEX	CNCA-C23-01	2020312310000213 (Ex ec IIC T4 Gc)
	EAC Brjansker Zertifizierungsstelle	TP TC 012/2011	EAC RU C-DE.AM02.B.00163 /19 (2Ex nA IIC T4 Gc X)
	IECEX TUEV Nord Cert GmbH	IEC 60079-0	IECEX TUN 14.0035 X (Ex ec IIC T4 Gc)
	INMETRO TÜV Rheinland do Brasil Ltda.	IEC 60079-0	BR-Ex_TÜV 12.1297 X
	UKEx WAGO GmbH & Co. KG	EN 60079-0	UKCA_WAGO22UKEX003X_ec
	UL	UL 121201	E198726 Sec.1

Subject to changes. Please also observe the further product documentation!

WAGO GmbH & Co. KG
Hansastr. 27
32423 Minden
Phone: +49571 887-0 | Fax: +49571 887-169
Email: info.de@wago.com | Web: www.wago.com

Do you have any questions about our products?
We are always happy to take your call at +49 (571) 887-44222.



Underwriters Laboratories Inc. (HAZARDOUS LOCATIONS)

Required accessories

Pluggable connector

Male connector/plug



Item no.: 753-110
Plug

www.wago.com/753-110

Optional accessories

System housing

System enclosure



Item no.: 850-814/002-000
IP65 enclosure; Sheet steel (RAL 7035); WxHxD (200x120x200 mm); without flange plate

www.wago.com/850-814/002-000



Item no.: 850-815/002-000
IP65 enclosure; Sheet steel (RAL 7035); WxHxD (300x120x200 mm); without flange plate

www.wago.com/850-815/002-000



Item no.: 850-816/002-000
IP65 enclosure; Sheet steel (RAL 7035); WxHxD (400x120x200 mm); without flange plate

www.wago.com/850-816/002-000



Item no.: 850-817/002-000
IP65 enclosure; Sheet steel (RAL 7035); WxHxD (600x120x200 mm); without flange plate

www.wago.com/850-817/002-000



Item no.: 850-825
IP65 enclosure; Aluminium (RAL 7032); WxHxD (160x100x160 mm); 9 x M12, 4 x M20

www.wago.com/850-825



Item no.: 850-826
IP65 enclosure; Aluminium (RAL 7032); WxHxD (240x100x160 mm); 4 x M20, 4 x M16, 14 x M12 cable grip

www.wago.com/850-826



Item no.: 850-827
IP65 enclosure; Aluminium (RAL 7032); WxHxD (320x100x160 mm); 4 x M20, 8 x M16, 17 x M12 cable grip

www.wago.com/850-827



Item no.: 850-827/002-000
IP65 enclosure; Aluminium (RAL 7035); WxHxD (320x100x160 mm); 4 x M20, 8 x M16, 17 x M12 cable grip

www.wago.com/850-827/002-000

Item no.: 850-826/002-000

Subject to changes. Please also observe the further product documentation!

WAGO GmbH & Co. KG

Hansastr. 27

32423 Minden

Phone: +49571 887-0 | Fax: +49571 887-169

Email: info.de@wago.com | Web: www.wago.com

Do you have any questions about our products?

We are always happy to take your call at +49 (571) 887-44222.



IP65 enclosure; Aluminium (RAL 7035); WxHxD (240x100x160 mm); 4 x M20, 4 x M16, 14 x M12 cable grip

www.wago.com/850-826/002-000



Item no.: 850-828/002-000

IP65 enclosure; Aluminium (RAL 7035); WxHxD (480x100x160 mm); 4 x M20, 10 x M16, 35 x M12 cable grip

www.wago.com/850-828/002-000



Item no.: 850-828

IP65 enclosure; Aluminium (RAL 7032); WxHxD (480x100x160 mm); 4 x M20, 10 x M16, 35 x M12 cable grip

www.wago.com/850-828



Item no.: 850-834

IP65 enclosure; Polyester (RAL 7032); WxHxD (164x100x164 mm); 9 x M12, 4 x M20

www.wago.com/850-834



Item no.: 850-835

IP65 enclosure; Polyester (RAL 7032); WxHxD (244x100x164 mm); 4 x M20, 4 x M16, 14 x M12 cable grip

www.wago.com/850-835



Item no.: 850-836

IP65 enclosure; Polyester (RAL 7032); WxHxD (324x100x164 mm); 4 x M20, 8 x M16, 17 x M12 cable grip

www.wago.com/850-836

Shield termination

Shield clamping saddles



Item no.: 790-116

Shield clamping saddle; 19 mm wide; diameter of compatible conductor; 7 ... 16 mm

www.wago.com/790-116



Item no.: 790-124

Shield clamping saddle; 27 mm wide; diameter of compatible conductor; 6 ... 24 mm

www.wago.com/790-124



Item no.: 790-108

Shield clamping saddle; 11 mm wide; diameter of compatible conductor; 3 ... 8 mm

www.wago.com/790-108



Item no.: 790-140

Shield clamping saddle; diameter of compatible conductor

www.wago.com/790-140



Item no.: 790-216

Shield clamping saddle; 21.8 mm wide; 6 ... 16 mm

www.wago.com/790-216



Item no.: 790-220

Shield clamping saddle; 30 mm wide; 6 ... 20 mm

www.wago.com/790-220



Item no.: 790-208

Shield clamping saddle; 12.4 mm wide; 3 ... 8 mm

www.wago.com/790-208

Carrier rail

Mounting accessories



Item no.: 210-197

Steel carrier rail; 35 x 15 mm; 1.5 mm thick; 2 m long; slotted; similar to EN 60715; silver-colored

www.wago.com/210-197

Item no.: 210-198

Subject to changes. Please also observe the further product documentation!

WAGO GmbH & Co. KG

Hansastr. 27

32423 Minden

Phone: +49571 887-0 | Fax: +49571 887-169



Email: info.de@wago.com | Web: www.wago.com

Do you have any questions about our products?













We are always happy to take your call at +49 (571) 887-44222.

	Copper carrier rail; 35 x 15 mm; 2.3 mm thick; 2 m long; unslotted; according to EN 60715; copper-colored	www.wago.com/210-198
	Item no.: 210-504 Steel carrier rail; 35 x 7.5 mm; 1 mm thick; 2 m long; slotted; galvanized; according to EN 60715; silver-colored	www.wago.com/210-504
	Item no.: 210-505 Steel carrier rail; 35 x 7.5 mm; 1 mm thick; 2 m long; unslotted; galvanized; according to EN 60715; silver-colored	www.wago.com/210-505
	Item no.: 210-506 Steel carrier rail; 35 x 15 mm; 1.5 mm thick; 2 m long; unslotted; galvanized; similar to EN 60715; silver-colored	www.wago.com/210-506
	Item no.: 210-508 Steel carrier rail; 35 x 15 mm; 1.5 mm thick; 2 m long; slotted; galvanized; similar to EN 60715; silver-colored	www.wago.com/210-508
	Item no.: 210-113 Steel carrier rail; 35 x 7.5 mm; 1 mm thick; 2 m long; unslotted; according to EN 60715; silver-colored	www.wago.com/210-113
	Item no.: 210-118 Steel carrier rail; 35 x 15 mm; 2.3 mm thick; 2 m long; unslotted; according to EN 60715; silver-colored	www.wago.com/210-118
	Item no.: 210-112 Steel carrier rail; 35 x 7.5 mm; 1 mm thick; 2 m long; slotted; according to EN 60715; "Hole width 25 mm; silver-colored	www.wago.com/210-112
	Item no.: 210-114 Steel carrier rail; 35 x 15 mm; 1.5 mm thick; 2 m long; unslotted; similar to EN 60715; silver-colored	www.wago.com/210-114
	Item no.: 210-115 Steel carrier rail; 35 x 7.5 mm; 1 mm thick; 2 m long; slotted; according to EN 60715; "Hole width 18 mm; silver-colored	www.wago.com/210-115
	Item no.: 210-196 Aluminum carrier rail; 35 x 8.2 mm; 1.6 mm thick; 2 m long; unslotted; similar to EN 60715; silver-colored	www.wago.com/210-196

Marking accessories

Marker carrier		
	Item no.: 750-103 Group marker carrier	www.wago.com/750-103
Marker		
	Item no.: 2009-145/000-006 Mini-WSB Inline; for Smart Printer; 1700 pieces on roll; stretchable 5 - 5.2 mm; plain; snap-on type; blue	www.wago.com/2009-145/000-006
	Item no.: 2009-145 Mini-WSB Inline; for Smart Printer; 1700 pieces on roll; stretchable 5 - 5.2 mm; plain; snap-on type; white	www.wago.com/2009-145

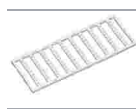
Subject to changes. Please also observe the further product documentation!

	Item no.: 2009-145/000-002 Mini-WSB Inline; for Smart Printer; 1700 pieces on roll; stretchable 5 - 5.2 mm; plain; snap-on type; yellow	www.wago.com/2009-145/000-002
	Item no.: 2009-145/000-007 Mini-WSB Inline; for Smart Printer; 1700 pieces on roll; stretchable 5 - 5.2 mm; plain; snap-on type; gray	www.wago.com/2009-145/000-007
	Item no.: 2009-145/000-005 Mini-WSB Inline; for Smart Printer; 1700 pieces on roll; stretchable 5 - 5.2 mm; plain; snap-on type; red	www.wago.com/2009-145/000-005
	Item no.: 2009-145/000-012 Mini-WSB Inline; for Smart Printer; 1700 pieces on roll; stretchable 5 - 5.2 mm; plain; snap-on type; orange	www.wago.com/2009-145/000-012
	Item no.: 2009-145/000-023 Mini-WSB Inline; for Smart Printer; 1700 pieces on roll; stretchable 5 - 5.2 mm; plain; snap-on type; green	www.wago.com/2009-145/000-023
	Item no.: 2009-145/000-024 Mini-WSB Inline; for Smart Printer; 1700 pieces on roll; stretchable 5 - 5.2 mm; plain; snap-on type; violet	www.wago.com/2009-145/000-024
	Item no.: 248-501/000-006 Mini-WSB marking card; as card; not stretchable; plain; snap-on type; blue	www.wago.com/248-501/000-006
	Item no.: 248-501/000-007 Mini-WSB marking card; as card; not stretchable; plain; snap-on type; gray	www.wago.com/248-501/000-007
	Item no.: 248-501/000-002 Mini-WSB marking card; as card; not stretchable; plain; snap-on type; yellow	www.wago.com/248-501/000-002
	Item no.: 248-501/000-012 Mini-WSB marking card; as card; not stretchable; plain; snap-on type; orange	www.wago.com/248-501/000-012
	Item no.: 248-501 Mini-WSB marking card; as card; not stretchable; plain; snap-on type; white	www.wago.com/248-501
	Item no.: 248-501/000-017 Mini-WSB marking card; as card; not stretchable; plain; snap-on type; light green	www.wago.com/248-501/000-017

Subject to changes. Please also observe the further product documentation!



Item no.: 248-501/000-005
Mini-WSB marking card; as card; not stretchable; plain; snap-on type; red

www.wago.com/248-501/000-005



Item no.: 248-501/000-024
Mini-WSB marking card; as card; not stretchable; plain; snap-on type; violet

www.wago.com/248-501/000-024



Item no.: 248-501/000-023
Mini-WSB marking card; as card; not stretchable; plain; snap-on type; green

www.wago.com/248-501/000-023



Item no.: 750-100
Marker card; as a DIN A4 sheet; plain

www.wago.com/750-100

Group marker carrier



Item no.: 750-106
Group marker carrier

www.wago.com/750-106

Pluggable connector

Coding



Item no.: 753-150
753 Series coding elements

www.wago.com/753-150

Supply module

Supply module



Item no.: 750-601
Power Supply; 24 VDC; fuse holder

www.wago.com/750-601



Item no.: 750-610
Power Supply; 24 VDC; fuse holder; Diagnostics

www.wago.com/750-610



Item no.: 750-602
Power Supply; 24 VDC

www.wago.com/750-602



Item no.: 750-612
Power Supply; 0 ... 230 V AC/DC

www.wago.com/750-612



Item no.: 753-612
Power Supply; 0 ... 230 V AC/DC

www.wago.com/753-612



Item no.: 753-602
Power Supply; 24 VDC

www.wago.com/753-602

Downloads

Documentation

Subject to changes. Please also observe the further product documentation!



Manual

System Manual WAGO I/O System 750/753 Decentralized Automation Technology	V 3.3.0 2023 May 4	pdf 8.8 MB	Download
Product Manual 2-channel, 24VDC Intruder detection	V 1.2.0	pdf 2.1 MB	Download
System Manual Series 750/753 Online HTML		URL	Download

Bid Text

753-424 X81 - Datei	2019 Feb 19	xml 4.3 kB	Download
753-424 doc - Datei	2017 Jul 13	doc 28.7 kB	Download

Instruction Leaflet

CCC Ex (Additional information) WAGO-I/O-SYSTEM *750-****/*	2023 Apr 26	pdf 163.6 kB	Download
--	-------------	-----------------	----------

System Description

750/753 Series I/O-System – General Product Information		pdf 1.7 MB	Download
Overview on WAGO-I/O-SYSTEM 750 approvals		pdf 789.0 kB	Download

Additional Information

Disposal and Recycling Electrical and electronic equipment, Batteries, Packaging	V 1.1.0 2022 Aug 18	pdf 2.2 MB	Download
---	------------------------	---------------	----------

CAD/CAE-Data

CAD data

2D/3D Models 753-424		URL	Download
----------------------	--	-----	----------

CAE data

W3CAD | Inverse 753-424

Subject to changes. Please also observe the further product documentation!

WAGO GmbH & Co. KG
Hansastr. 27
32423 Minden
Phone: +49571 887-0 | Fax: +49571 887-169
Email: info.de@wago.com | Web: www.wago.com

Do you have any questions about our products?
We are always happy to take your call at +49 (571) 887-44222.

Data sheet | Item number: 753-424

www.wago.com/753-424



[WAGO Universe 753-424](#)

[URL](#) [Download](#)

[ZUKEN Portal 753-424](#)

[URL](#) [Download](#)

[EPLAN Data Portal 753-424](#)

[URL](#) [Download](#)

Environmental Product Compliance

Compliance Search

[Environmental Product Compliance 753-424](#)

[URL](#) [Download](#)

2-channel digital input; 24 VDC; Intruder detection

Installation Notes

Product family

[WAGO I/O System 750/753](#)

[Show all products from the family](#)

Subject to changes. Please also observe the further product documentation!

WAGO GmbH & Co. KG

Hansastr. 27

32423 Minden

Phone: +49571 887-0 | Fax: +49571 887-169

Email: info.de@wago.com | Web: www.wago.com

Do you have any questions about our products?

We are always happy to take your call at +49 (571) 887-44222.