

**Data sheet | Item number: 279-509**

Double-deck terminal block; 4-conductor through terminal block; N; suitable for Ex i applications; internal commoning; conductor entry with violet marking; for DIN-rail 35 x 15 and 35 x 7.5; 1.5 mm<sup>2</sup>; 1,50 mm<sup>2</sup>; blue

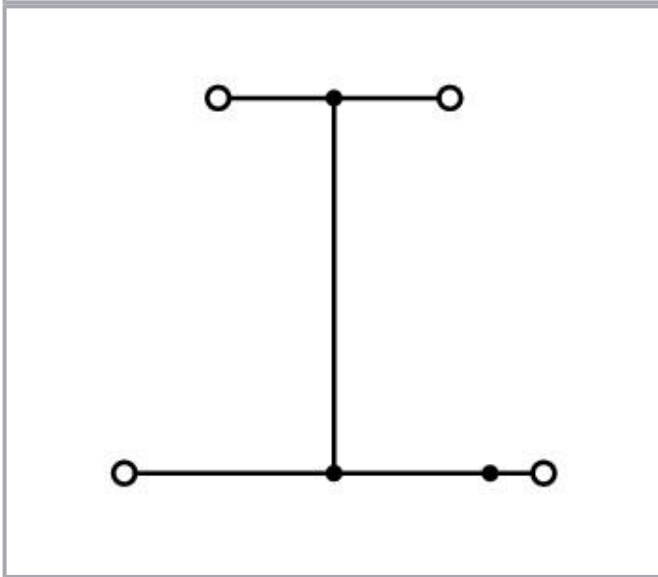

[www.wago.com/279-509](http://www.wago.com/279-509)

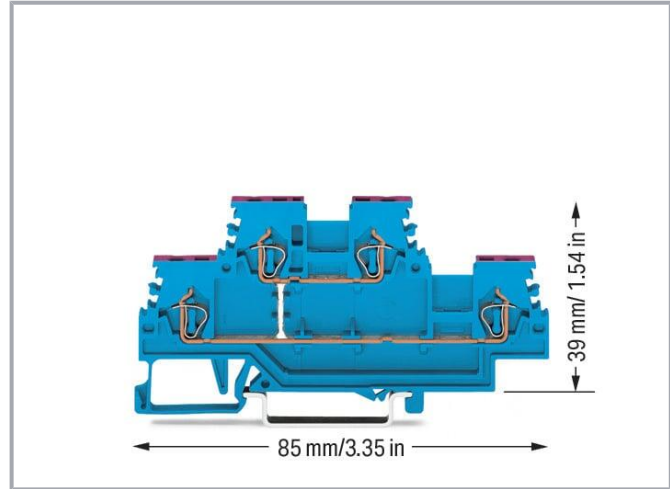
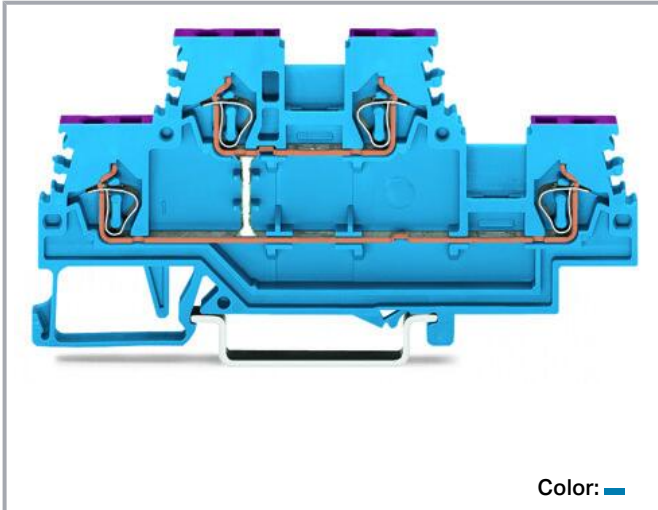

**Data**

**Electrical data**

**Ratings per IEC/EN**

Ratings per

IEC/EN 60947-7-1

Subject to changes. Please also observe the further product documentation!

WAGO GmbH & Co. KG  
Hansastr. 27  
32423 Minden  
Phone: +49571 887-0 | Fax: +49571 887-169  
Email: [info.de@wago.com](mailto:info.de@wago.com) | Web: [www.wago.com](http://www.wago.com)

Do you have any questions about our products?  
We are always happy to take your call at +49 (571) 887-44222.



Nominal voltage (III/3)	500 V
Rated impulse voltage (III/3)	6 kV
Rated current	18 A
Legend (ratings)	(III / 3) $\triangleq$ Overvoltage category III / Pollution degree 3

### Ratings per UL 1059

Approvals per	UL 1059
Rated voltage UL (Use Group C)	600 V
Rated current UL (Use Group C)	10 A

### Ratings per CSA

Approvals per	CSA 22.2 No 158
Rated voltage CSA (Use Group C)	600 V
Rated current CSA (Use Group C)	10 A

### Power loss

Power loss, per pole (potential)	0.593 W
Rated current $I_N$ for specified power loss	18 A
Resistance value for specified, current-dependent power loss	0.002 $\Omega$

### Connection data

Connection points	4
Total number of potentials	1
Number of levels	2

### Connection 1

Connection technology	CAGE CLAMP <sup>®</sup>
Actuation type	Operating tool
Connectable conductor materials	Copper
Solid conductor	0.08 ... 1.5 mm <sup>2</sup> / 28 ... 16 AWG
Fine-stranded conductor	0.08 ... 1.5 mm <sup>2</sup> / 28 ... 16 AWG
Strip length	8 ... 9 mm / 0.31 ... 0.35 inches
Wiring direction	Front-entry wiring

Subject to changes. Please also observe the further product documentation!



## Physical data

Width	4 mm / 0.157 inches
Height	85 mm / 3.346 inches
Depth from upper-edge of DIN-rail	39 mm / 1.535 inches

## Mechanical Data

Potential marking	N
Design	horizontal type
Mounting type	DIN-35 rail
Marking level	Side marking

## Material Data

Note (material data)	Information on material specifications can be found here
Color	blue
Material group	I
Insulation material	Polyamide (PA66)
Flammability class per UL94	V0
Fire load	0.146 MJ
Weight	7.8 g

## Environmental requirements

Processing temperature	-35 ... +85 °C
Continuous operating temperature	-60 ... +105 °C

## Commercial data

Product Group	1 (Rail Mounted Terminal Blocks)
eCl@ss 10.0	27-14-11-20
eCl@ss 9.0	27-14-11-20
ETIM 8.0	EC000897
ETIM 7.0	EC000897
PU (SPU)	50 pcs
Packaging type	box
Country of origin	CN

Subject to changes. Please also observe the further product documentation!





GTIN	4050821614142
Customs tariff number	85369010000

### Environmental Product Compliance



RoHS Compliance Status	Compliant, No Exemption
------------------------	-------------------------

### Approvals / Certificates

#### General approvals

Logo	Approval	Additional Approval Text	Certificate name
	CCA DEKRA Certification B.V.	EN 60947	NTR NL-7081
	CSA DEKRA Certification B.V.	C22.2 No. 158	70133738
	KEMA/KEUR DEKRA Certification B.V.	EN 60947	2160584.04
	UL Underwriters Laboratories Inc.	UL 1059	E45172

#### Declarations of conformity and manufacturer's declarations

Logo	Approval	Additional Approval Text	Certificate name
	EU-Declaration of Conformity WAGO GmbH & Co. KG	-	-
	UK-Declaration of Conformity WAGO GmbH & Co. KG	-	-

#### Approvals for marine applications

Logo	Approval	Additional Approval Text	Certificate name
------	----------	--------------------------	------------------

Subject to changes. Please also observe the further product documentation!

WAGO GmbH & Co. KG  
Hansastr. 27  
32423 Minden  
Phone: +49571 887-0 | Fax: +49571 887-169  
Email: [info.de@wago.com](mailto:info.de@wago.com) | Web: [www.wago.com](http://www.wago.com)

Do you have any questions about our products?  
We are always happy to take your call at +49 (571) 887-44222.



**ABS**  
American Bureau of Shipping

-

20-  
HG1941090-  
PDA



**DNV GL**  
Det Norske Veritas, Germanischer Lloyd

-

TAE00001V2

## Required accessories

### End plate

End plate



**Item no.: 279-519**  
End and intermediate plate; 2 mm thick; orange

[www.wago.com/279-519](http://www.wago.com/279-519)



**Item no.: 279-518**  
End and intermediate plate; 2 mm thick; gray

[www.wago.com/279-518](http://www.wago.com/279-518)

## Optional accessories

### Protective warning marker

Cover



**Item no.: 279-415**  
Protective warning marker; 5-pole; with high-voltage symbol, black; yellow

[www.wago.com/279-415](http://www.wago.com/279-415)

### Testing and measuring

Testing accessories



**Item no.: 209-170**  
Test plug adapter; 8.3 mm wide; for 4 mm Ø test plugs; suitable for 1.5 mm<sup>2</sup> - 10 mm<sup>2</sup> tbs; gray

[www.wago.com/209-170](http://www.wago.com/209-170)



**Item no.: 280-404**  
Test plug adapter; 5 mm wide; for test plug (2.3 mm Ø); suitable for 1.5 mm<sup>2</sup> - 4 mm<sup>2</sup> tbs; gray

[www.wago.com/280-404](http://www.wago.com/280-404)

### Marking accessories

Marker carrier



**Item no.: 279-529**  
Adaptor; gray

[www.wago.com/279-529](http://www.wago.com/279-529)

Double marker carrier















**Item no.: 209-128**  
Adaptor; gray

[www.wago.com/209-128](http://www.wago.com/209-128)

Marker

Subject to changes. Please also observe the further product documentation!

	<b>Item no.: 2009-114/000-002</b> WMB-Inline; for Smart Printer; 2000 pieces on roll; stretchable 4 - 4.2 mm; plain; snap-on type; yellow	<a href="http://www.wago.com/2009-114/000-002">www.wago.com/2009-114/000-002</a>
	<b>Item no.: 2009-114/000-005</b> WMB-Inline; for Smart Printer; 2000 pieces on roll; stretchable 4 - 4.2 mm; plain; snap-on type; red	<a href="http://www.wago.com/2009-114/000-005">www.wago.com/2009-114/000-005</a>
	<b>Item no.: 2009-114/000-007</b> WMB-Inline; for Smart Printer; 2000 pieces on roll; stretchable 4 - 4.2 mm; plain; snap-on type; gray	<a href="http://www.wago.com/2009-114/000-007">www.wago.com/2009-114/000-007</a>
	<b>Item no.: 2009-114/000-023</b> WMB-Inline; for Smart Printer; 2000 pieces on roll; stretchable 4 - 4.2 mm; plain; snap-on type; green	<a href="http://www.wago.com/2009-114/000-023">www.wago.com/2009-114/000-023</a>
	<b>Item no.: 2009-114/000-006</b> WMB-Inline; for Smart Printer; 2000 pieces on roll; stretchable 4 - 4.2 mm; plain; snap-on type; blue	<a href="http://www.wago.com/2009-114/000-006">www.wago.com/2009-114/000-006</a>
	<b>Item no.: 2009-114/000-024</b> WMB-Inline; for Smart Printer; 2000 pieces on roll; stretchable 4 - 4.2 mm; plain; snap-on type; violet	<a href="http://www.wago.com/2009-114/000-024">www.wago.com/2009-114/000-024</a>
	<b>Item no.: 2009-114/000-012</b> WMB-Inline; for Smart Printer; 2000 pieces on roll; stretchable 4 - 4.2 mm; plain; snap-on type; orange	<a href="http://www.wago.com/2009-114/000-012">www.wago.com/2009-114/000-012</a>
	<b>Item no.: 2009-114</b> WMB-Inline; for Smart Printer; 2000 pieces on roll; stretchable 4 - 4.2 mm; plain; snap-on type; white	<a href="http://www.wago.com/2009-114">www.wago.com/2009-114</a>
	<b>Item no.: 793-4501/000-002</b> WMB marking card; as card; stretchable 4 - 4.2 mm; plain; snap-on type; yellow	<a href="http://www.wago.com/793-4501/000-002">www.wago.com/793-4501/000-002</a>
	<b>Item no.: 793-4501/000-006</b> WMB marking card; as card; stretchable 4 - 4.2 mm; plain; snap-on type; blue	<a href="http://www.wago.com/793-4501/000-006">www.wago.com/793-4501/000-006</a>
	<b>Item no.: 793-4501</b> WMB marking card; as card; stretchable 4 - 4.2 mm; plain; snap-on type; white	<a href="http://www.wago.com/793-4501">www.wago.com/793-4501</a>
	<b>Item no.: 793-4501/000-023</b> WMB marking card; as card; stretchable 4 - 4.2 mm; plain; snap-on type; green	<a href="http://www.wago.com/793-4501/000-023">www.wago.com/793-4501/000-023</a>

Subject to changes. Please also observe the further product documentation!



**Item no.: 793-4501/000-024**  
WMB marking card; as card; stretchable 4 - 4.2 mm; plain; snap-on type; violet

[www.wago.com/793-4501/000-024](http://www.wago.com/793-4501/000-024)



**Item no.: 793-4501/000-005**  
WMB marking card; as card; stretchable 4 - 4.2 mm; plain; snap-on type; red

[www.wago.com/793-4501/000-005](http://www.wago.com/793-4501/000-005)



**Item no.: 793-4501/000-007**  
WMB marking card; as card; stretchable 4 - 4.2 mm; plain; snap-on type; gray

[www.wago.com/793-4501/000-007](http://www.wago.com/793-4501/000-007)



**Item no.: 793-4501/000-012**  
WMB marking card; as card; stretchable 4 - 4.2 mm; plain; snap-on type; orange

[www.wago.com/793-4501/000-012](http://www.wago.com/793-4501/000-012)



**Item no.: 793-4501/000-017**  
WMB marking card; as card; stretchable 4 - 4.2 mm; plain; snap-on type; light green

[www.wago.com/793-4501/000-017](http://www.wago.com/793-4501/000-017)

Group marker carrier



**Item no.: 209-142**  
Group marker carrier; gray

[www.wago.com/209-142](http://www.wago.com/209-142)



**Item no.: 209-141**  
Group marker carrier; gray

[www.wago.com/209-141](http://www.wago.com/209-141)



**Item no.: 209-140**  
Group marker carrier; gray

[www.wago.com/209-140](http://www.wago.com/209-140)



**Item no.: 249-105**  
Group marker carrier; gray

[www.wago.com/249-105](http://www.wago.com/249-105)

Carrier rail

Mounting accessories



**Item no.: 210-197**  
Steel carrier rail; 35 x 15 mm; 1.5 mm thick; 2 m long; slotted; similar to EN 60715; silver-colored

[www.wago.com/210-197](http://www.wago.com/210-197)



**Item no.: 210-198**  
Copper carrier rail; 35 x 15 mm; 2.3 mm thick; 2 m long; unslotted; according to EN 60715; copper-colored

[www.wago.com/210-198](http://www.wago.com/210-198)



**Item no.: 210-504**  
Steel carrier rail; 35 x 7.5 mm; 1 mm thick; 2 m long; slotted; galvanized; according to EN 60715; silver-colored

[www.wago.com/210-504](http://www.wago.com/210-504)

Subject to changes. Please also observe the further product documentation!

	<b>Item no.: 210-505</b> Steel carrier rail; 35 x 7.5 mm; 1 mm thick; 2 m long; unslotted; galvanized; according to EN 60715; silver-colored	<a href="http://www.wago.com/210-505">www.wago.com/210-505</a>
	<b>Item no.: 210-506</b> Steel carrier rail; 35 x 15 mm; 1.5 mm thick; 2 m long; unslotted; galvanized; similar to EN 60715; silver-colored	<a href="http://www.wago.com/210-506">www.wago.com/210-506</a>
	<b>Item no.: 210-508</b> Steel carrier rail; 35 x 15 mm; 1.5 mm thick; 2 m long; slotted; galvanized; similar to EN 60715; silver-colored	<a href="http://www.wago.com/210-508">www.wago.com/210-508</a>
	<b>Item no.: 210-113</b> Steel carrier rail; 35 x 7.5 mm; 1 mm thick; 2 m long; unslotted; according to EN 60715; silver-colored	<a href="http://www.wago.com/210-113">www.wago.com/210-113</a>
	<b>Item no.: 210-118</b> Steel carrier rail; 35 x 15 mm; 2.3 mm thick; 2 m long; unslotted; according to EN 60715; silver-colored	<a href="http://www.wago.com/210-118">www.wago.com/210-118</a>
	<b>Item no.: 210-112</b> Steel carrier rail; 35 x 7.5 mm; 1 mm thick; 2 m long; slotted; according to EN 60715; "Hole width 25 mm; silver-colored	<a href="http://www.wago.com/210-112">www.wago.com/210-112</a>
	<b>Item no.: 210-114</b> Steel carrier rail; 35 x 15 mm; 1.5 mm thick; 2 m long; unslotted; similar to EN 60715; silver-colored	<a href="http://www.wago.com/210-114">www.wago.com/210-114</a>
	<b>Item no.: 210-115</b> Steel carrier rail; 35 x 7.5 mm; 1 mm thick; 2 m long; slotted; according to EN 60715; "Hole width 18 mm; silver-colored	<a href="http://www.wago.com/210-115">www.wago.com/210-115</a>
	<b>Item no.: 210-196</b> Aluminum carrier rail; 35 x 8.2 mm; 1.6 mm thick; 2 m long; unslotted; similar to EN 60715; silver-colored	<a href="http://www.wago.com/210-196">www.wago.com/210-196</a>
<b>Push-in type wire jumper</b>		
Jumper		
	<b>Item no.: 249-123</b> Push-in type wire jumper; 0.75 mm <sup>2</sup> ; insulated; 180 mm long; black	<a href="http://www.wago.com/249-123">www.wago.com/249-123</a>
	<b>Item no.: 249-126</b> Push-in type wire jumper; 0.75 mm <sup>2</sup> ; insulated; 110 mm long; black	<a href="http://www.wago.com/249-126">www.wago.com/249-126</a>
	<b>Item no.: 249-127</b> Push-in type wire jumper; 0.75 mm <sup>2</sup> ; insulated; 250 mm long; black	<a href="http://www.wago.com/249-127">www.wago.com/249-127</a>
	<b>Item no.: 249-125</b> Push-in type wire jumper; insulated; 60 mm long; black	<a href="http://www.wago.com/249-125">www.wago.com/249-125</a>
<b>Insulation stop</b>		
Insulation stop		
	<b>Item no.: 279-470</b> Insulation stop; 0.08 - 0.2 mm <sup>2</sup> "s" (0.14 mm <sup>2</sup> "f-st"); 5 pieces/strip; white	<a href="http://www.wago.com/279-470">www.wago.com/279-470</a>

Subject to changes. Please also observe the further product documentation!





**Item no.: 279-471**  
Insulation stop; 0.25 mm<sup>2</sup>; 5 pieces/strip; dark gray

## Mounting

### Cover carrier

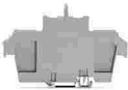

**Item no.: 709-168**  
Cover carrier; Type 2; incl. fixing/retaining screws and knurled nut; suitable for 283 to 285 Series rail-mounted terminal blocks; suitable for 279 to 281 Series double- and triple-deck terminal blocks; suitable for 780 to 785, 775, 776 and 777 Series TOPJOB® rail-mounted terminal blocks; suitable for 280 Series sensor and actuator terminal blocks; suitable for 282 Series disconnect/test terminal blocks for transformer circuits; gray

[www.wago.com/709-168](http://www.wago.com/709-168)

### Cover



**Item no.: 709-154**  
Cover; Type 2; suitable for cover carrier, type 2; 1 m long; transparent

[www.wago.com/709-154](http://www.wago.com/709-154)

### Mounting accessories



**Item no.: 209-106**  
Mounting carrier; for isolated mounting on DIN 35 rails; gray

[www.wago.com/209-106](http://www.wago.com/209-106)











**Item no.: 249-116**  
Screwless end stop; 6 mm wide; for DIN-rail 35 x 15 and 35 x 7.5; gray

[www.wago.com/249-116](http://www.wago.com/249-116)

## Ferrule

### Ferrule

	<b>Item no.: 216-101</b> Ferrule; Sleeve for 0.5 mm <sup>2</sup> / AWG 22; uninsulated; electro-tin plated; silver-colored	<a href="http://www.wago.com/216-101">www.wago.com/216-101</a>
	<b>Item no.: 216-102</b> Ferrule; Sleeve for 0.75 mm <sup>2</sup> / AWG 20; uninsulated; electro-tin plated; silver-colored	<a href="http://www.wago.com/216-102">www.wago.com/216-102</a>
	<b>Item no.: 216-103</b> Ferrule; Sleeve for 1 mm <sup>2</sup> / AWG 18; uninsulated; electro-tin plated	<a href="http://www.wago.com/216-103">www.wago.com/216-103</a>
	<b>Item no.: 216-203</b> Ferrule; Sleeve for 1 mm <sup>2</sup> / AWG 18; insulated; electro-tin plated; red	<a href="http://www.wago.com/216-203">www.wago.com/216-203</a>
	<b>Item no.: 216-202</b> Ferrule; Sleeve for 0.75 mm <sup>2</sup> / 18 AWG; insulated; electro-tin plated; gray	<a href="http://www.wago.com/216-202">www.wago.com/216-202</a>
	<b>Item no.: 216-201</b> Ferrule; Sleeve for 0.5 mm <sup>2</sup> / 20 AWG; insulated; electro-tin plated; white	<a href="http://www.wago.com/216-201">www.wago.com/216-201</a>
	<b>Item no.: 216-301</b> Ferrule; Sleeve for 0.25 mm <sup>2</sup> / AWG 24; insulated; electro-tin plated; yellow	<a href="http://www.wago.com/216-301">www.wago.com/216-301</a>
	<b>Item no.: 216-302</b> Ferrule; Sleeve for 0.34 mm <sup>2</sup> / 22 AWG; insulated; electro-tin plated; light turquoise	<a href="http://www.wago.com/216-302">www.wago.com/216-302</a>

## Jumpers

Subject to changes. Please also observe the further product documentation!

WAGO GmbH & Co. KG  
Hansastr. 27  
32423 Minden  
Phone: +49571 887-0 | Fax: +49571 887-169  
Email: [info.de@wago.com](mailto:info.de@wago.com) | Web: [www.wago.com](http://www.wago.com)



Do you have any questions about our products?  
We are always happy to take your call at +49 (571) 887-44222.

## Jumper

	<b>Item no.: 279-402</b> Jumper; insulated; gray	<a href="http://www.wago.com/279-402">www.wago.com/279-402</a>
	<b>Item no.: 279-409</b> Jumper; insulated; gray	<a href="http://www.wago.com/279-409">www.wago.com/279-409</a>
	<b>Item no.: 279-422</b> Jumper; insulated; yellow-green	<a href="http://www.wago.com/279-422">www.wago.com/279-422</a>
	<b>Item no.: 279-492</b> Jumper; 2-way; insulated; gray	<a href="http://www.wago.com/279-492">www.wago.com/279-492</a>
	<b>Item no.: 279-490</b> Jumper; 10-way; insulated; gray	<a href="http://www.wago.com/279-490">www.wago.com/279-490</a>
	<b>Item no.: 279-482</b> Jumper; 2-way; insulated; gray	<a href="http://www.wago.com/279-482">www.wago.com/279-482</a>
	<b>Item no.: 279-483</b> Jumper; 3-way; insulated; gray	<a href="http://www.wago.com/279-483">www.wago.com/279-483</a>

## Tool

## Operating tool

	<b>Item no.: 210-648</b> Operating tool; Blade: 2.5 x 0.4 mm; with a partially insulated shaft; angled; short	<a href="http://www.wago.com/210-648">www.wago.com/210-648</a>
	<b>Item no.: 210-647</b> Operating tool; Blade: 2.5 x 0.4 mm; with a partially insulated shaft; multicoloured	<a href="http://www.wago.com/210-647">www.wago.com/210-647</a>
	<b>Item no.: 210-719</b> Operating tool; Blade: 2.5 x 0.4 mm; with a partially insulated shaft	<a href="http://www.wago.com/210-719">www.wago.com/210-719</a>

## Downloads

## Documentation

## Bid Text

279-509 X81 - Datei	2019 Feb 19	xml 3.4 kB	Download
279-509 doc - Datei	2017 Feb 28	doc 25.1 kB	Download

## Additional Information

Technical Section	pdf	Download
-------------------	-----	----------

Subject to changes. Please also observe the further product documentation!

## CAD/CAE-Data

### CAD data

2D/3D Models 279-509	<a href="#">URL</a>	<a href="#">Download</a>
----------------------	---------------------	--------------------------

### CAE data

WSCAD Universe 279-509	<a href="#">URL</a>	<a href="#">Download</a>
------------------------	---------------------	--------------------------

ZUKEN Portal 279-509	<a href="#">URL</a>	<a href="#">Download</a>
----------------------	---------------------	--------------------------

EPLAN Data Portal 279-509	<a href="#">URL</a>	<a href="#">Download</a>
---------------------------	---------------------	--------------------------

## Environmental Product Compliance

### Compliance Search

Environmental Product Compliance 279-509	<a href="#">URL</a>	<a href="#">Download</a>
--	---------------------	--------------------------

Double-deck terminal block; 4-conductor through terminal block; N; suitable for Ex i applications; internal commoning; conductor entry with violet marking; for DIN-rail 35 x 15 and 35 x 7.5; 1.5 mm<sup>2</sup>; 1,50 mm<sup>2</sup>; blue

## Installation Notes

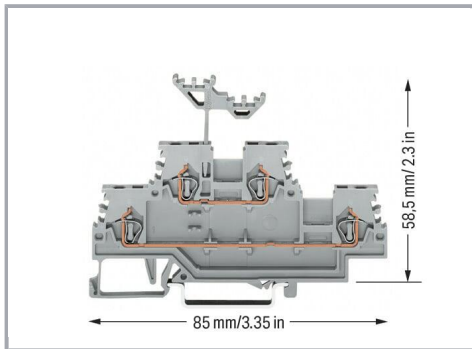

### Double-deck marker carrier

(height including marker carrier)

## Product family

Subject to changes. Please also observe the further product documentation!



**Classic**

EPSITRON® CLASSIC POWER: The Robust Power Supply – with Integrated TopBoost (Optional)

[Show all products from the family](#)

Subject to changes. Please also observe the further product documentation!

---

WAGO GmbH & Co. KG  
Hansastr. 27  
32423 Minden  
Phone: +49571 887-0 | Fax: +49571 887-169  
Email: [info.de@wago.com](mailto:info.de@wago.com) | Web: [www.wago.com](http://www.wago.com)

Do you have any questions about our products?  
We are always happy to take your call at +49 (571) 887-44222.