

CHIP COIL (CHIP INDUCTORS) LQG15WZ□□□□02D
Murata Standard Reference Specification [AEC-Q200]

1.Scope

This reference specification applies to Chip coil (Chip Inductors) LQG15WZ series for Automotive Electronics based on AEC-Q200 except for Power train and Safety.

2.Part Numbering

(ex) LQ G 15 W Z 1N0 S 0 2 D
 Product ID Structure Dimension Applications Category Inductance Tolerance Features Electrode Packaging
 (L×W) and for Automotive Characteristics Electronics D:Taping

3.Rating

- Operating Temperature Range. -55°C to +125°C
- Storage Temperature Range. -55°C to +125°C

Customer Part Number	MURATA Part Number	Inductance (nH)	Tolerance	Q (min.)	DC Resistance (Ω max.)	Self Resonant Frequency (MHz min.)	Rated Current (mA)	ESD Rank 1C:1kV
	LQG15WZ0N7B02D	0.7	B:±0.1nH C:±0.2nH S:±0.3nH	-	0.03	15000	1200	1C
	LQG15WZ0N7C02D							
	LQG15WZ0N7S02D							
	LQG15WZ0N8B02D	0.8						
	LQG15WZ0N8C02D							
	LQG15WZ0N8S02D							
	LQG15WZ0N9B02D	0.9						
	LQG15WZ0N9C02D							
	LQG15WZ0N9S02D							
	LQG15WZ1N0B02D	1.0						
	LQG15WZ1N0C02D							
	LQG15WZ1N0S02D							
	LQG15WZ1N1B02D	1.1						
	LQG15WZ1N1C02D							
	LQG15WZ1N1S02D							
	LQG15WZ1N2B02D	1.2						
	LQG15WZ1N2C02D							
	LQG15WZ1N2S02D							
	LQG15WZ1N3B02D	1.3						
	LQG15WZ1N3C02D							
	LQG15WZ1N3S02D							
	LQG15WZ1N4B02D	1.4						
	LQG15WZ1N4C02D							
	LQG15WZ1N4S02D							
	LQG15WZ1N5B02D	1.5						
	LQG15WZ1N5C02D							
	LQG15WZ1N5S02D							
	LQG15WZ1N6B02D	1.6						
	LQG15WZ1N6C02D							
	LQG15WZ1N6S02D							
	LQG15WZ1N7B02D	1.7						
	LQG15WZ1N7C02D							
	LQG15WZ1N7S02D							
	LQG15WZ1N8B02D	1.8						
	LQG15WZ1N8C02D							
	LQG15WZ1N8S02D							
	LQG15WZ1N9B02D	1.9						
	LQG15WZ1N9C02D							
	LQG15WZ1N9S02D							

Customer Part Number	MURATA Part Number	Inductance (nH)	Tolerance	Q (min.)	DC Resistance (Ω max.)	Self Resonant Frequency (MHz min.)	Rated Current (mA)	ESD Rank 1C:1kV
	LQG15WZ2N0B02D	2.0	B: ± 0.1 nH C: ± 0.2 nH S: ± 0.3 nH	23	0.05	8000	1000	1C
	LQG15WZ2N0C02D							
	LQG15WZ2N0S02D							
	LQG15WZ2N1B02D	2.1			0.06			
	LQG15WZ2N1C02D							
	LQG15WZ2N1S02D							
	LQG15WZ2N2B02D	2.2			0.07			
	LQG15WZ2N2C02D							
	LQG15WZ2N2S02D							
	LQG15WZ2N3B02D	2.3			0.06			
	LQG15WZ2N3C02D							
	LQG15WZ2N3S02D							
	LQG15WZ2N4B02D	2.4			0.07			
	LQG15WZ2N4C02D							
	LQG15WZ2N4S02D							
	LQG15WZ2N5B02D	2.5			0.06			
	LQG15WZ2N5C02D							
	LQG15WZ2N5S02D							
	LQG15WZ2N6B02D	2.6			0.07			
	LQG15WZ2N6C02D							
	LQG15WZ2N6S02D							
	LQG15WZ2N7B02D	2.7			0.07			
	LQG15WZ2N7C02D							
	LQG15WZ2N7S02D							
	LQG15WZ2N8B02D	2.8			0.08			
	LQG15WZ2N8C02D							
	LQG15WZ2N8S02D							
	LQG15WZ2N9B02D	2.9			0.08			
	LQG15WZ2N9C02D							
	LQG15WZ2N9S02D							
	LQG15WZ3N0B02D	3.0	0.09					
	LQG15WZ3N0C02D							
	LQG15WZ3N0S02D							
	LQG15WZ3N1B02D	3.1	0.09					
	LQG15WZ3N1C02D							
	LQG15WZ3N1S02D							
	LQG15WZ3N2B02D	3.2	0.08					
	LQG15WZ3N2C02D							
	LQG15WZ3N2S02D							
	LQG15WZ3N3B02D	3.3	0.09					
	LQG15WZ3N3C02D							
	LQG15WZ3N3S02D							
	LQG15WZ3N4B02D	3.4	0.09					
	LQG15WZ3N4C02D							
	LQG15WZ3N4S02D							
	LQG15WZ3N5B02D	3.5	0.10					
	LQG15WZ3N5C02D							
	LQG15WZ3N5S02D							
	LQG15WZ3N6B02D	3.6	0.10					
	LQG15WZ3N6C02D							
	LQG15WZ3N6S02D							
	LQG15WZ3N7B02D	3.7	0.10					
	LQG15WZ3N7C02D							
	LQG15WZ3N7S02D							
	LQG15WZ3N8B02D	3.8	0.10					
	LQG15WZ3N8C02D							
	LQG15WZ3N8S02D							

Customer Part Number	MURATA Part Number	Inductance (nH)	Tolerance	Q (min.)	DC Resistance (Ω max.)	Self Resonant Frequency (MHz min.)	Rated Current (mA)	ESD Rank 1C:1kV
	LQG15WZ3N9B02D	3.9	B: ± 0.1 nH C: ± 0.2 nH S: ± 0.3 nH	23	0.09	5000	900	1C
	LQG15WZ3N9C02D							
	LQG15WZ3N9S02D							
	LQG15WZ4N1B02D	4.1						
	LQG15WZ4N1C02D							
	LQG15WZ4N1S02D							
	LQG15WZ4N3B02D	4.3						
	LQG15WZ4N3C02D							
	LQG15WZ4N3S02D							
	LQG15WZ4N7B02D	4.7						
	LQG15WZ4N7C02D							
	LQG15WZ4N7S02D							
	LQG15WZ5N1B02D	5.1						
	LQG15WZ5N1C02D							
	LQG15WZ5N1S02D							
	LQG15WZ5N6B02D	5.6						
	LQG15WZ5N6C02D							
	LQG15WZ5N6S02D							
	LQG15WZ5N8B02D	5.8						
	LQG15WZ5N8C02D							
	LQG15WZ5N8S02D							
	LQG15WZ6N2B02D	6.2						
	LQG15WZ6N2C02D							
	LQG15WZ6N2S02D							
	LQG15WZ6N8G02D	6.8						
	LQG15WZ6N8H02D							
	LQG15WZ6N8J02D							
	LQG15WZ7N3G02D	7.3						
	LQG15WZ7N3H02D							
	LQG15WZ7N3J02D							
	LQG15WZ7N5G02D	7.5						
	LQG15WZ7N5H02D							
	LQG15WZ7N5J02D							
	LQG15WZ8N2G02D	8.2						
	LQG15WZ8N2H02D							
	LQG15WZ8N2J02D							
	LQG15WZ8N7G02D	8.7						
	LQG15WZ8N7H02D							
	LQG15WZ8N7J02D							
	LQG15WZ9N1G02D	9.1						
	LQG15WZ9N1H02D							
	LQG15WZ9N1J02D							
	LQG15WZ9N5G02D	9.5						
	LQG15WZ9N5H02D							
	LQG15WZ9N5J02D							
	LQG15WZ10NG02D	10						
	LQG15WZ10NH02D							
	LQG15WZ10NJ02D							
	LQG15WZ11NG02D	11						
	LQG15WZ11NH02D							
	LQG15WZ11NJ02D							
	LQG15WZ12NG02D	12						
	LQG15WZ12NH02D							
	LQG15WZ12NJ02D							
	LQG15WZ13NG02D	13						
	LQG15WZ13NH02D							
	LQG15WZ13NJ02D							
			G: $\pm 2\%$ H: $\pm 3\%$ J: $\pm 5\%$					

Customer Part Number	MURATA Part Number	Inductance (nH)	Tolerance	Q (min.)	DC Resistance (Ω max.)	Self Resonant Frequency (MHz min.)	Rated Current (mA)	ESD Rank 1C:1kV
	LQG15WZ15NG02D	15	G: $\pm 2\%$ H: $\pm 3\%$ J: $\pm 5\%$	23	0.28	2300	400	1C
	LQG15WZ15NH02D							
	LQG15WZ15NJ02D							
	LQG15WZ16NG02D	16		20	0.8			
	LQG15WZ16NH02D							
	LQG15WZ16NJ02D							
	LQG15WZ18NG02D	18		22	0.8	2100		
	LQG15WZ18NH02D							
	LQG15WZ18NJ02D							
	LQG15WZ19NG02D	19		20	1.1	2000		
	LQG15WZ19NH02D							
	LQG15WZ19NJ02D							
	LQG15WZ20NG02D	20		22	1.2	1700		
	LQG15WZ20NH02D							
	LQG15WZ20NJ02D							
	LQG15WZ22NG02D	22		20	1.3	1600		
	LQG15WZ22NH02D							
	LQG15WZ22NJ02D							
	LQG15WZ23NG02D	23		22	1.5	1400		
	LQG15WZ23NH02D							
	LQG15WZ23NJ02D							
	LQG15WZ24NG02D	24		20	1.6	1300		
	LQG15WZ24NH02D							
	LQG15WZ24NJ02D							
	LQG15WZ27NG02D	27	22	1.8	1200			
	LQG15WZ27NH02D							
	LQG15WZ27NJ02D							
	LQG15WZ30NG02D	30	20	1.9	1100			
	LQG15WZ30NH02D							
	LQG15WZ30NJ02D							
	LQG15WZ33NG02D	33	22	1.9	1100			
	LQG15WZ33NH02D							
	LQG15WZ33NJ02D							
	LQG15WZ36NG02D	36	20	1.9	1100			
	LQG15WZ36NH02D							
	LQG15WZ36NJ02D							
	LQG15WZ39NG02D	39	22	1.9	1100			
	LQG15WZ39NH02D							
	LQG15WZ39NJ02D							
	LQG15WZ40NG02D	40	20	1.9	1100			
	LQG15WZ40NH02D							
	LQG15WZ40NJ02D							
	LQG15WZ43NG02D	43	22	1.9	1100			
	LQG15WZ43NH02D							
	LQG15WZ43NJ02D							
	LQG15WZ47NG02D	47	20	1.9	1100			
	LQG15WZ47NH02D							
	LQG15WZ47NJ02D							
	LQG15WZ51NG02D	51	22	1.9	1100			
	LQG15WZ51NH02D							
	LQG15WZ51NJ02D							
	LQG15WZ56NG02D	56	20	1.9	1100			
	LQG15WZ56NH02D							
	LQG15WZ56NJ02D							
	LQG15WZ62NG02D	62	22	1.9	1100			
	LQG15WZ62NH02D							
	LQG15WZ62NJ02D							

Customer Part Number	MURATA Part Number	Inductance (nH)	Tolerance	Q (min.)	DC Resistance (Ω max.)	Self Resonant Frequency (MHz min.)	Rated Current (mA)	ESD Rank 1C:1kV
		(*1)(refer to below comment)						
	LQG15WZ68NG02D	68	G: $\pm 2\%$ H: $\pm 3\%$ J: $\pm 5\%$	22	2.0	1100	160	1C
	LQG15WZ68NH02D							
	LQG15WZ68NJ02D							
	LQG15WZ72NG02D	72			2.2			
	LQG15WZ72NH02D							
	LQG15WZ72NJ02D							
	LQG15WZ75NG02D	75		2.3				
	LQG15WZ75NH02D							
	LQG15WZ75NJ02D							
	LQG15WZ82NG02D	82		2.5				
	LQG15WZ82NH02D							
	LQG15WZ82NJ02D							
	LQG15WZ91NG02D	91		2.7				
	LQG15WZ91NH02D							
	LQG15WZ91NJ02D							
	LQG15WZR10G02D	100	2.9					
	LQG15WZR10H02D							
	LQG15WZR10J02D							
	LQG15WZR11G02D	110	3.0					
	LQG15WZR11H02D							
	LQG15WZR11J02D							
	LQG15WZR12G02D	120	800	140				
	LQG15WZR12H02D							
	LQG15WZR12J02D							
	LQG15WZR13G02D	130	110					
	LQG15WZR13H02D							
	LQG15WZR13J02D							
	LQG15WZR15G02D	150						
	LQG15WZR15H02D							
	LQG15WZR15J02D							

(*1) Standard Testing Conditions

《Unless otherwise specified》

Temperature : Ordinary Temperature / 15°C to 35°C

Humidity : Ordinary Humidity / 25%(RH) to 85%(RH)

《In case of doubt》

Temperature : 20°C \pm 2°C

Humidity : 60%(RH) to 70%(RH)

Atmospheric Pressure : 86kPa to 106 kPa

4. Appearance and Dimensions

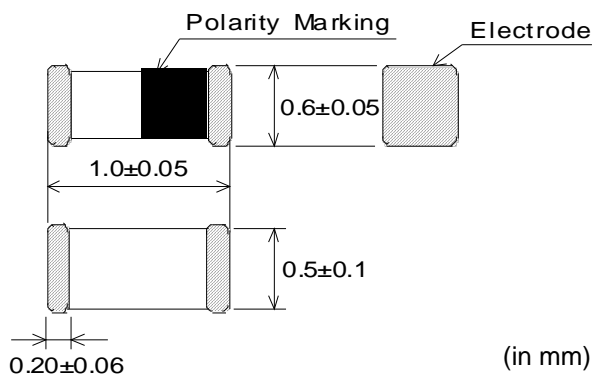

5. Electrical Performance

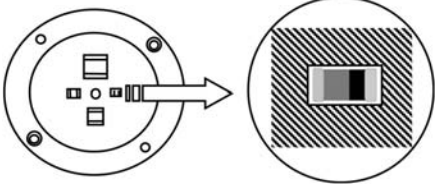
No.	Item	Specification	Test Method
5.1	Inductance	Inductance shall meet item 3.	Measuring Equipment: Keysight E4991A or equivalent Measuring Frequency:100MHz (Inductance) 250MHz (Q) Measuring Condition: Test signal level/about 0dBm Electrode spaces / 0.5mm Electrical length/10mm Weight/about 1N to 5N Measuring Fixture: Keysight 16197A Position coil under test as shown in below and contact coil with each terminal by adding weight. Polarity marking should be a topside, and polarity marking should be in the direction of the fixture for position of chip coil.
5.2	Q	Q shall meet item 3.	 Measuring Method: See the endnote [Electrical Performance: Measuring Method of Inductance/Q]
5.3	DC Resistance	DC Resistance shall meet item 3.	Measuring Equipment: Digital multi meter
5.4	Self Resonant Frequency (S.R.F)	S.R.F shall meet item 3.	Measuring Equipment: Keysight N5230A or equivalent
5.5	Rated Current	Self temperature rise shall be limited to 25°C max.	The allowable current is applied.

6. Q200 Requirement

6.1. Performance (based on Table 5 for Magnetics (Inductors / Transformer))

AEC-Q200 Rev.D issued June 1. 2010

AEC-Q200			Murata Specification / Deviation				
No	Stress	Test Method					
3	High Temperature Exposure	1000hours at 125 deg C Set for 24hours at room temperature, then measured.	Meet Table A after testing. Table A <table border="1"> <tr> <td>Appearance</td> <td>No damage</td> </tr> <tr> <td>Inductance Change (at 100MHz)</td> <td>Within ±10%</td> </tr> </table>	Appearance	No damage	Inductance Change (at 100MHz)	Within ±10%
Appearance	No damage						
Inductance Change (at 100MHz)	Within ±10%						
4	Temperature Cycling	1000cycles -40 deg C to +125 deg C Set for 24hours at room temperature, then measured.	Meet Table A after testing.				
7	Biased Humidity	1000hours at 85 deg C, 85%RH unpowered.	Meet Table A after testing.				
8	Operational Life	Apply 125 deg C 1000hours Set for 24hours at room temperature, then measured	Meet Table A after testing.				
9	External Visual	Visual inspection	No abnormalities				
10	Physical Dimension	Meet ITEM 4 (Style and Dimensions)	No defects				
12	Resistance to Solvents	Per MIL-STD-202 Method 215	Not Applicable				
13	Mechanical Shock	Per MIL-STD-202 Method 213 Condition C : 100g's(0.98N), 6ms, Half sine, 12.3ft/s	Meet Table A after testing.				

AEC-Q200			Murata Specification / Deviation						
No	Stress	Test Method							
14	Vibration	5g's(0.049N) for 20 minutes, 12cycles each of 3 orientations Test from 10-2000Hz.	Meet Table A after testing.						
15	Resistance to Soldering Heat	No-heating Solder temperature 260C+/-5 deg C Immersion time 10s	Meet Table A after testing. Pre-heating 150C +/-10 deg C, 60s to 90s						
17	ESD	Per AEC-Q200-002	ESD Rank: refer to the Item3 (Rating). Meet Table A after testing						
18	Solderbility	Per J-STD-002	Method b : Not Applicable 90% of the terminations is to be soldered.						
19	Electrical Characterization	Measured : Inductance	No defects						
20	Flammability	Per UL-94	Not Applicable						
21	Board Flex	Epoxy-PCB(1.6mm) Deflection 2mm(min) Holding time 60s	Meet Table B after testing. <table border="1" style="margin-left: 20px;"> <thead> <tr> <th colspan="2">Table B</th> </tr> </thead> <tbody> <tr> <td>Appearance</td> <td>No damage</td> </tr> <tr> <td>DC resistance Change</td> <td>Within ±10%</td> </tr> </tbody> </table>	Table B		Appearance	No damage	DC resistance Change	Within ±10%
Table B									
Appearance	No damage								
DC resistance Change	Within ±10%								
22	Terminal Strength	Per AEC-Q200-006 A force of 17.7N for 60s	Murata Deviation Request: 5N No defects						

7.Specification of Packaging

7.1 Appearance and Dimensions of paper tape (8mm-wide)

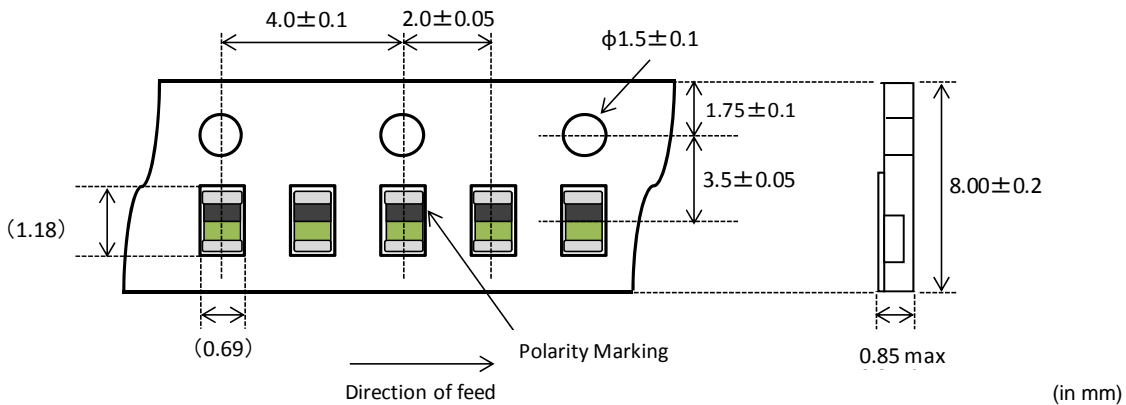

7.2 Specification of Taping

- (1) Packing quantity (standard quantity)
10,000 pcs. / reel
- (2) Packing Method
Products shall be packed in the cavity of the base tape and sealed by top tape.
- (3) Sprocket hole
The sprocket holes are to the right as the tape is pulled toward the user.
- (4) Spliced point
Base tape and Top tape has no spliced point.
- (5) Missing components number
Missing components number within 0.1 % of the number per reel or 1 pc., whichever is greater, and are not continuous. The Specified quantity per reel is kept.

7.3 Pull Strength

Top tape	5N min.
----------	---------

7.4 Peeling off force of cover tape

Speed of Peeling off	300mm/min
Peeling off force	0.1N to 0.6N (minimum value is typical)

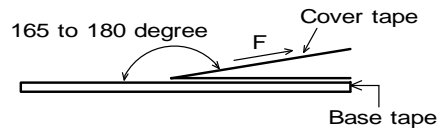

7.5 Dimensions of Leader-tape,Trailer and Reel

There shall be leader-tape (top tape and empty tape) and trailer-tape (empty tape) as follows.

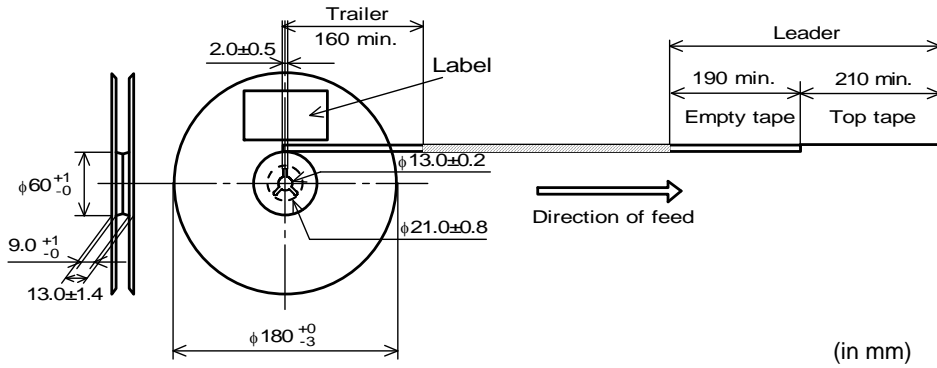

7.6 Marking for reel

Customer part number, MURATA part number, Inspection number(*1) ,RoHS Marking(*2), Quantity etc ...

*1) <Expression of Inspection No.>

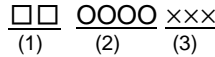

- (1) Factory Code
- (2) Date First digit : Year / Last digit of year
 Second digit: Month / Jan. to Sep. → 1 to 9, Oct. to Dec. → O, N, D
 Third, Fourth digi : Day
- (3) Serial No.

*2) <Expression of RoHS Marking>

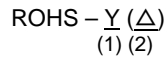

- (1) RoHS regulation conformity parts.
- (2) MURATA classification number

7.7 Marking for Outside package (corrugated paper box)

Customer name, Purchasing order number, Customer part number, MURATA part number, RoHS Marking(*2) ,Quantity, etc ...

7.8. Specification of Outer Case

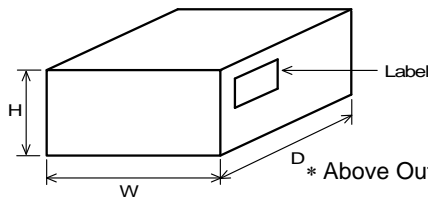

Outer Case Dimensions (mm)			Standard Reel Quantity in Outer Case (Reel)
W	D	H	
186	186	93	5

* Above Outer Case size is typical. It depends on a quantity of an order.

8. ⚠ Caution

8.1 Caution(Rating)

Do not exceed maximum rated current of the product. Thermal stress may be transmitted to the product and short/open circuit of the product or falling off the product may be occurred.

8.2 Fail-safe

Be sure to provide an appropriate fail-safe function on your product to prevent a second damage that may be caused by the abnormal function or the failure of our product.

8.3 Limitation of Applications

Please contact us before using our products for the applications listed below which require especially high reliability for the prevention of defects which might directly cause damage to the third party's life, body or property.

- | | |
|-----------------------------------|--|
| (1) Aircraft equipment | (6) Transportation equipment (trains, ships, etc.) |
| (2) Aerospace equipment | (7) Traffic signal equipment |
| (3) Undersea equipment | (8) Disaster prevention / crime prevention equipment |
| (4) Power plant control equipment | (9) Data-processing equipment |
| (5) Medical equipment | (10) Applications of similar complexity and /or reliability requirements to the applications listed in the above |

9. Notice

Products can only be soldered with reflow.

This product is designed for solder mounting.

Please consult us in advance for applying other mounting method such as conductive adhesive.

9.1 Land pattern designing

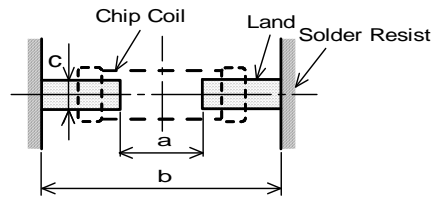

a	0.5
b	1.2
c	0.65

(in mm)

9.2 Flux, Solder

- Use rosin-based flux.
- Don't use highly acidic flux with halide content exceeding 0.2(wt)% (chlorine conversion value).
- Don't use water-soluble flux.
- Use Sn-3.0Ag-0.5Cu solder.
- Standard thickness of solder paste : 100 μ m to 150 μ m.

9.3 Reflow soldering conditions

- Inductance value may be changed a little due to the amount of solder.
- So, the chip coil shall be soldered by reflow so that the solder volume can be controlled.
- Pre-heating should be in such a way that the temperature difference between solder and product surface is limited to 150°C max. Cooling into solvent after soldering also should be in such a way that the temperature difference is limited to 100°C max.
- Insufficient pre-heating may cause cracks on the product, resulting in the deterioration of products quality.
- Standard soldering profile and the limit soldering profile is as follows.
- The excessive limit soldering conditions may cause leaching of the electrode and / or resulting in the deterioration of product quality.

- Reflow soldering profile

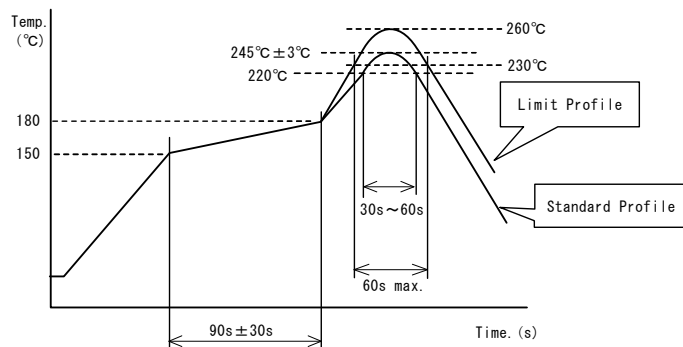

	Standard Profile	Limit Profile
Pre-heating	150°C ~ 180°C , 90s ± 30s	
Heating	above 220°C, 30s ~ 60s	above 230°C, 60s max.
Peak temperature	245°C ± 3°C	260°C, 10s
Cycle of reflow	2 times	2 times

9.4 Reworking with soldering iron

The following conditions must be strictly followed when using a soldering iron.

Pre-heating	150°C, 1 min
Tip temperature	350°C max.
Soldering iron output	80W max.
Tip diameter	φ3mm max.
Soldering time	3(+1,-0)s
Time	2 times

Note :Do not directly touch the products with the tip of the soldering iron in order to prevent the crack on the products due to the thermal shock.

9.5 Solder Volume

- Solder shall be used not to be exceed the upper limits as shown below.
- Accordingly increasing the solder volume, the mechanical stress to Chip is also increased. Exceeding solder volume may cause the failure of mechanical or electrical performance.

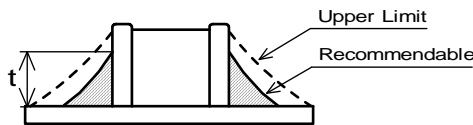

$1/3T \leq t \leq T$
 T : thickness of product

9.6 Mount Shock

Over Mechanical stress to products at mounting process causes crack and electrical failure etc.

9.7 Product's location

The following shall be considered when designing and laying out P.C.B.'s.

- (1) P.C.B. shall be designed so that products are not subjected to the mechanical stress due to warping the board.

[Products direction]

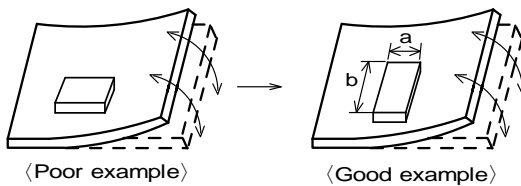

Products shall be located in the sideways direction (Length:a < b) to the mechanical stress.

- (2) Components location on P.C.B. separation.

It is effective to implement the following measures, to reduce stress in separating the board.

It is best to implement all of the following three measures; however, implement as many measures as possible to reduce stress.

Contents of Measures	Stress Level
(1) Turn the mounting direction of the component parallel to the board separation surface.	A > D *1
(2) Add slits in the board separation part.	A > B
(3) Keep the mounting position of the component away from the board separation surface.	A > C

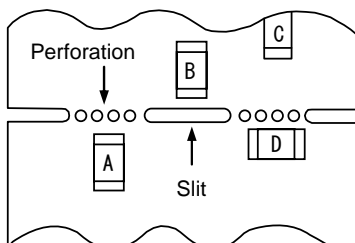

*1 A > D is valid when stress is added vertically to the perforation as with Hand Separation. If a Cutting Disc is used, stress will be diagonal to the PCB, therefore A > D is invalid.

(3) Mounting Components Near Screw Holes

When a component is mounted near a screw hole, it may be affected by the board deflection that occurs during the tightening of the screw. Mount the component in a position as far away from the screw holes as possible.

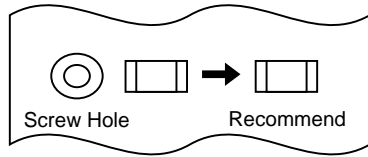
**9.8 Cleaning Conditions**

Products shall be cleaned on the following conditions.

- (1) Cleaning temperature shall be limited to 60°C max.(40°C max for IPA.)
- (2) Ultrasonic cleaning shall comply with the following conditions with avoiding the resonance phenomenon at the mounted products and P.C.B.
Power : 20 W / l max. Frequency : 28kHz to 40kHz Time : 5 min max.
- (3) Cleaner
 1. Alcohol type cleaner
Isopropyl alcohol (IPA)
 2. Aqueous agent
PINE ALPHA ST-100S
- (4) There shall be no residual flux and residual cleaner after cleaning. In the case of using aqueous agent, products shall be dried completely after rinse with de-ionized water in order to remove the cleaner.
- (5) Other cleaning Please contact us.

9.9 Resin coating

The inductance value may change and/or it may affect on the product's performance due to high cure-stress of resin to be used for coating / molding products. So please pay your careful attention when you select resin.

In prior to use, please make the reliability evaluation with the product mounted in your application set.

9.10 Handling of a substrate

After mounting products on a substrate, do not apply any stress to the product caused by bending or twisting to the substrate when cropping the substrate, inserting and removing a connector from the substrate or tightening screw to the substrate.

Excessive mechanical stress may cause cracking in the product.

Bending

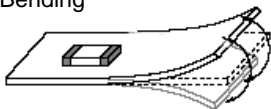

Twisting

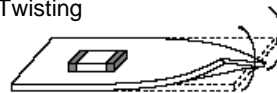
**9.11 Storage and Handling Requirements**

- (1) Storage period
 - Use the products within 6 months after delivered.
 - Solderability should be checked if this period is exceeded.
- (2) Storage conditions
 - Products should be stored in the warehouse on the following conditions.
Temperature: -10°C to 40°C
Humidity: 15% to 85% relative humidity No rapid change on temperature and humidity
 - Don't keep products in corrosive gases such as sulfur, chlorine gas or acid, or it may cause oxidization of electrode, resulting in poor solderability.
 - Products should be stored on the palette for the prevention of the influence from humidity, dust and so on.
 - Products should be stored in the warehouse without heat shock, vibration, direct sunlight and so on.
 - Products should be stored under the airtight packaged condition.
- (3) Handling Condition
 - Care should be taken when transporting or handling product to avoid excessive vibration or mechanical shock.

10. Note

- (1) Please make sure that your product has been evaluated in view of your specifications with our product being mounted to your product.
- (2) You are requested not to use our product deviating from the reference specifications.
- (3) The contents of this reference specification are subject to change without advance notice.
Please approve our product specifications or transact the approval sheet for product specifications before ordering.

<Electrical Performance:Measuring Method of Inductance/Q>

(1) Residual elements and stray elements of test fixture can be described by F-parameter shown in following.

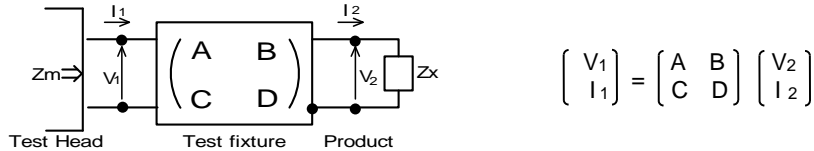

(2) The impedance of chip coil Z_x and measured value Z_m can be described by input/output current/voltage.

$$Z_m = \frac{V_1}{I_1} \quad , \quad Z_x = \frac{V_2}{I_2}$$

(3) Thus, the relation between Z_x and Z_m is following;

$$Z_x = \alpha \frac{Z_m - \beta}{1 - Z_m \Gamma} \quad \text{where, } \alpha = D / A = 1$$

$$\beta = B / D = Z_{sm} - (1 - Y_{om} Z_{sm}) Z_{ss}$$

$$\Gamma = C / A = Y_{om}$$

Z_{sm} :measured impedance of short chip
 Z_{ss} :residual impedance of short chip (0.556nH)
 Y_{om} :measured admittance when opening the fixture

(4) L_x and Q_x shall be calculated with the following equation.

$$L_x = \frac{\text{Im}(Z_x)}{2\pi f} \quad , \quad Q_x = \frac{\text{Im}(Z_x)}{\text{Re}(Z_x)}$$

L_x :Inductance of chip coil
 Q_x :Q of chip coil
 f :Measuring frequency