

SUMMARY

Wires

Low voltage 20



Image is for illustrative purpose only

Series 4B
Termination type Male crimp
IP rating 50
AWG wire size 24.00 - 20.00
Cable Ø 9.10 - 10.50 mm
Status active
Matching parts [EGG.4B.320.CLL](#)

Download

[Request a quote](#)

[Catalog](#)

TECHNICAL DETAILS

Mechanics

Shell Style/Model FN*: Straight plug, cable collet and lanyard release
Keying 1 key (alpha=0, plug: male contacts, receptacle: female contacts)
Housing Material Brass (chrome plated [SAE AMS 2460]) shell and collet nut, nickel plated [SAE AMS QQ N 290] brass latch sleeve and mid pieces
Variant Z : Nut for fitting a bend relief
Weight 119.06 g

Performance

Configuration 4B.320 : 20 Low Voltage
Insulator Y: PEEK for crimp contacts
Rated Current 8 Amps

Specifications

Contact Type: Crimp
Contact Retention: 30 N
Contact Dia.: 0.9 mm (0.035in)
Bucket Dia.: 1.1 mm (0.043in)
Min. Conductor: 0.25 mm² (AWG 24)
Max. Conductor: 0.5 mm² (AWG 20)

LEMO products and services are provided "as is". LEMO makes no warranties or representations with regard to LEMO product & services or use of them, express, implied or statutory, including for accuracy, completeness, or security. The user is fully responsible for his products and applications using LEMO components.

R (max): 4.8 mOhm
 Vtest (contact-shell): 950 V (AC), 1340 V (DC)
 Vtest (contact-contact): 1050 V (AC), 1490 V (DC)

Others

Endurance (Shell): 5000
 Temp (min / max): -55° C / +250° C
 Humidity (max): <=95% [at 60 deg C / 140 F]
 Vibration: 15 g [10 Hz - 2000 Hz]
 Shock Resistance: 100 g [6 ms]
 Climatical Category: 50/175/21
 Shielding (min): 75 dB (10 MHz)
 Shielding (min): 40 dB (1 GHz)
 Salt Spray Corrosion: >1000 hr

DRAWINGS

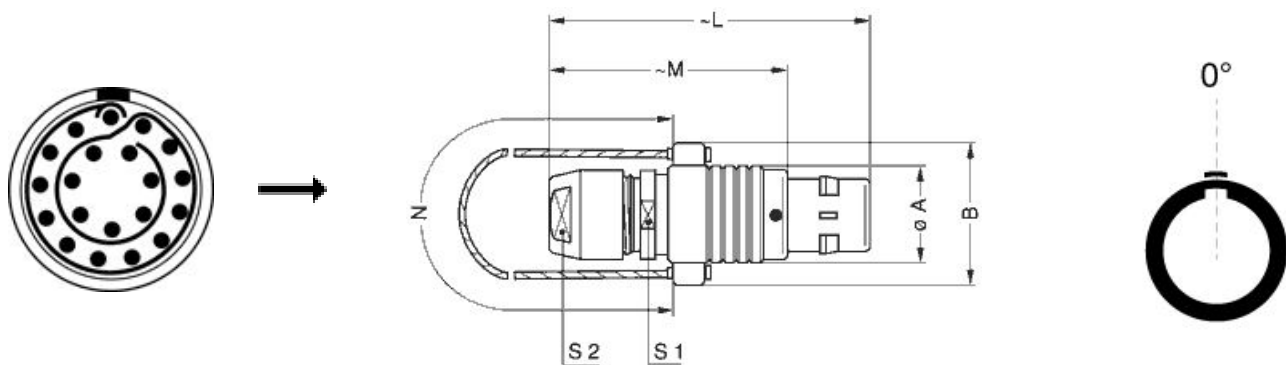

Dimensions

	A	B	L	M	N	S1	S2
mm.	25	35.2	75	57	230	21	20
in.	0,98	1,39	2,95	2,24	9,06	0,83	0,79

RECOMMENDED BY LEMO

LEMO products and services are provided "as is". LEMO makes no warranties or representations with regard to LEMO product & services or use of them, express, implied or statutory, including for accuracy, completeness, or security. The user is fully responsible for his products and applications using LEMO components.

Tools

Crimp Tool:	DPC.91.701.V
Crimp settings:	AWG/Selector = 20-22-24/6-5-5
Positionner:	DCE.91.094.BVC
Extractor:	DCF.91.093.5LT
Replacement contact:	FGG.4B.560.ZZC

Cables

LEMO products and services are provided "as is". LEMO makes no warranties or representations with regard to LEMO product & services or use of them, express, implied or statutory, including for accuracy, completeness, or security. The user is fully responsible for his products and applications using LEMO components.