

THIS DOCUMENT IS THE PROPERTY OF  
KEYSTONE ELECTRONICS CORP. AND  
SHALL NOT BE REPRODUCED, DISTRIBUTED  
OR USED AS A BASIS FOR MANUFACTURE  
WITHOUT PRIOR WRITTEN PERMISSION  
FROM KEYSTONE ELECTRONICS CORP.

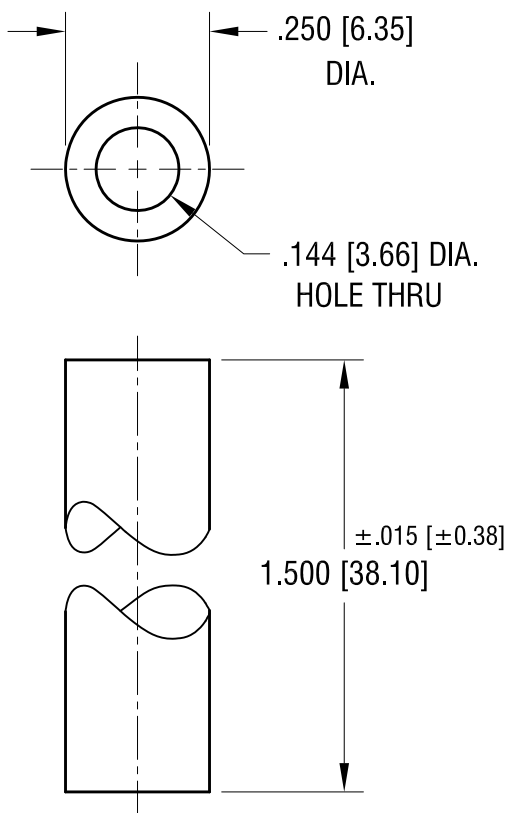

**KEYSTONE ELECTRONICS CORP.**

www.keyelco.com • ASTORIA, N.Y. 11105-2017 • Tel (718) 956-8900

PART NAME

NYLON THRU-HOLE SPACER

MATERIAL

NYLON 6/6

FINISH

-

DRN BY

BOONE

DATE

10.20.06

APP'D

LN

SCALE

3X

TOLERANCES

INCH [MM]

DECIMAL ± .005 [± 0.13 ]

ANGULAR ± 1°

UNLESS OTHERWISE SPECIFIED

CODE

C

DWG NO.

789

DATE

DESCRIPTION

REV.