



FOCUS LCDs

LCDs MADE SIMPLE[®]

Ph. 480-503-4295 | NOPP@FocusLCD.com

TFT | CHARACTER | UWVD | FSC | SEGMENT | CUSTOM | REPLACEMENT

TFT Display Module

Part Number

E35RF-I-RS730-R1

Overview:

- 3.5-inch TFT (76.9 (H)x63.9 (V))
- 320 x 240
- k8" @ 16.7M Colors
- Special Temperature Range
- All Viewing Angles
- Transmissive / Normally Black
- Resistive Touch Panel
- 850 NITS
- Controller : ST7272A
- RoHS Compliant

Description

This is a color active matrix TFT (Thin Film Transistor) LCD (Liquid Crystal Display) that uses amorphous silicon TFT as a switching device. This model is composed of a transmissive type TFT LCD Panel, driver circuit, capacitive touch panel, and a backlight unit. The resolution of this 3.5" TFT LCD contains 320(RGB)x240 pixels and can display up to 16.7M colors.

TFT Features

Low Input Voltage: 3.3V

Display Colors: 16.7M

TFT Interface: 24-bit RGB

General Information Items	Specification	Unit	Note
	Main Panel		
TFT Active area (AA)	70.08(H) x 52.56(V) (3.5 inch)	mm	-
Driver Element	TFT active matrix	-	-
Display Colors	16.7M	colors	-
Number of pixels	320(RGB)x240	dots	-
TFT Pixel arrangement	RGB vertical stripe	-	-
Pixel Pitch	0.219(H) x 0.219 (V)	mm	-
Viewing angle	All	o'clock	-
TFT Controller IC	ST7272A	-	-
TFT Interface	16/18/24bit RGB	-	-
Display mode	Transmissive/ Normally Black	-	-
Operating temperature	-30-+85	°C	-
Storage temperature	-40-+85	°C	-

Mechanical Information

Item		Min	Typ.	Max	Unit	Note
Module Size	Horizontal (H)		76.90		mm	-
	Vertical (V)		63.90		mm	-
	Depth (D)		4.35		mm	-
	Weight		tbd		g	

1. Block Diagram

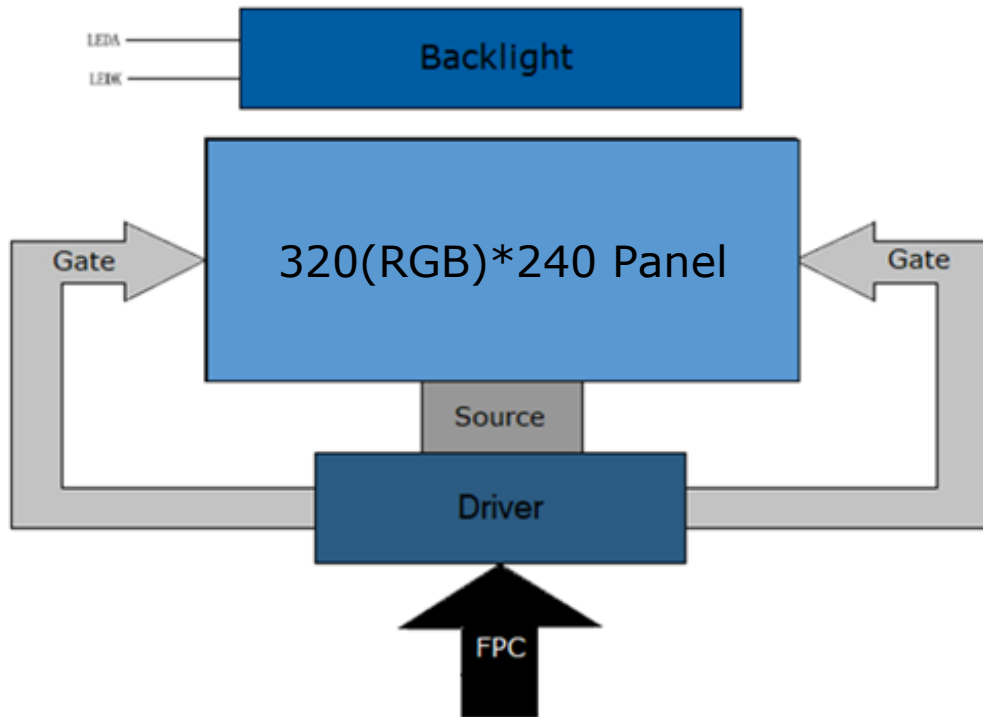

2. Outline Dimensions

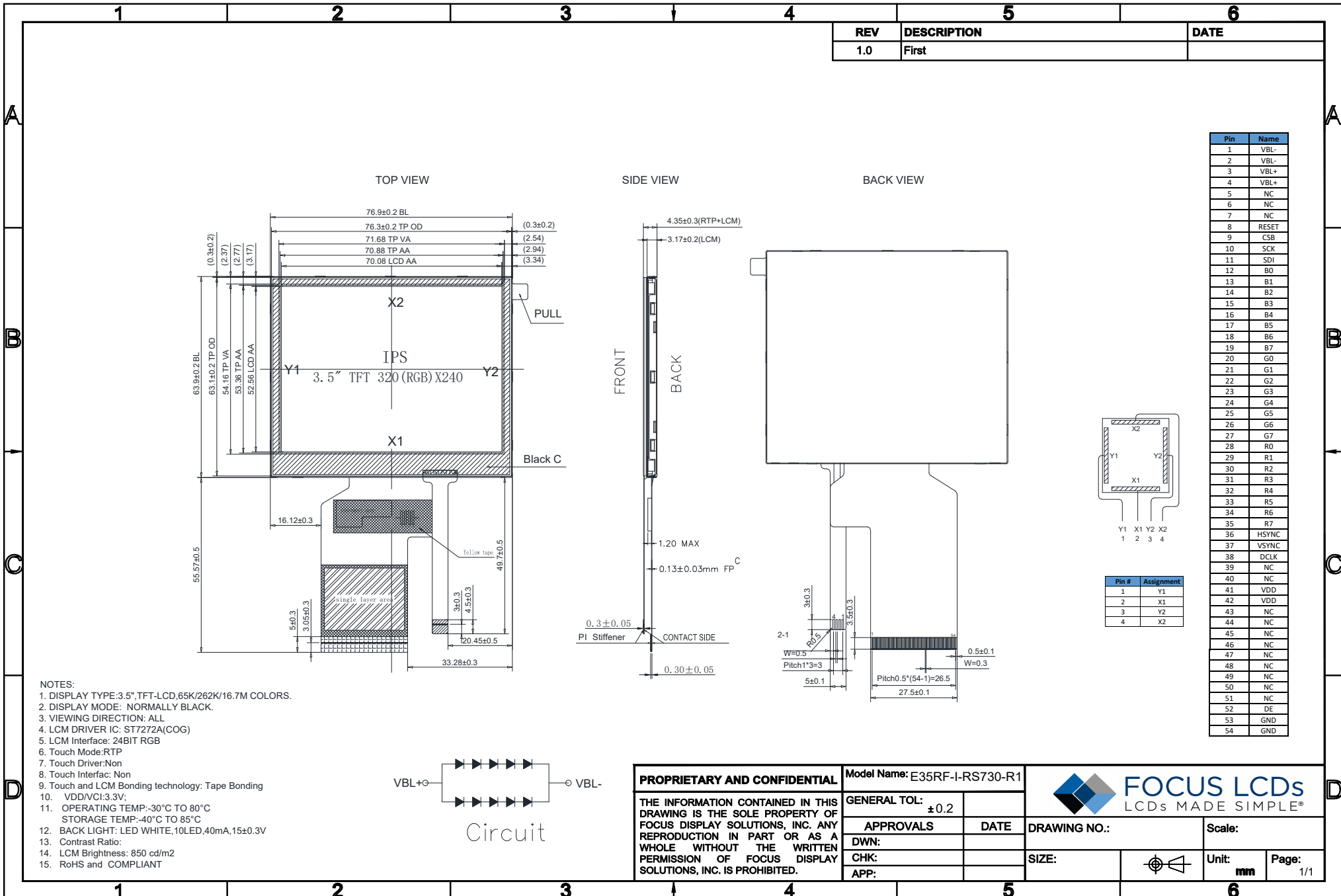

3. Input TFT Terminal Pin Assignment

Recommended Connector: F32Q-1A7H1-11054

NO.	Symbol	Description	I/O
1	VBL-	Cathode pin of backlight.	P
2	VBL-	Cathode pin of backlight.	P
3	VBL+	Anode pin of backlight.	P
4	VBL+	Anode pin of backlight.	P
5	NC	--	--
6	NC	--	--
7	NC	--	--
8	/RESET	Global reset pin. When /RESET is “L”, internal initialization procedure is executed.	I
9	CSB	Serial communication chip selection.	Open
10	SCK	Serial communication clock input.	Open
11	SDI	Serial communication data input and output.	Open
12-19	B0-B7	8 bit data bus display blue data. B[7:0] are not used in 8-bit RGB interface and should be connected to “L”.	I
20-27	G0-G7	8 bit data bus display green data. DG[7:0] are used in 8-bit RGB interface.	I
28-35	R0-R7	8 bit data bus display red data. DR[7:0] are not used in 8-bit RGB interface and should be connected to “L” .	I
36	HSYNC	Horizontal sync signal, default is negative polarity.	I
37	VSYNC	Vertical sync signal, default is negative polarity.	I
38	DCLK	Pixel clock input pin	I
39	NC	--	--
40	NC	--	--
41	VDD	Supply voltage(3.3V).	P
42	VDD	Supply voltage(3.3V).	P
43-51	NC	--	--
52	DE	Data input enable. Display access is enabled when DE is “H”.	I
53	GND	Ground.	P
54	GND	Ground.	P

3.1 RTP PIN Assignment

1	Y1(XL)	Touch panel LIFT Glass Terminal	A/D
2	X1(YD)	Touch panel Bottom Film Terminal	A/D
3	Y2(XR)	Touch panel Right Glass Terminal	A/D
4	X2(YU)	Touch panel Top Film Terminal	A/D

4. LCD Optical Characteristics

4.1 Optical Specifications

Item	Symbol	Condition	Min	Typ.	Max	Unit	Note	
Contrast Ratio	CR		640	800	--		(1)(2)	
Response time	Rising	T_R+T_F	$\Theta=0$ Normal viewing angle	--	30	40	msec	(1)(3)
	Falling							
Uniformity	S(%)		50	54.57	--	%	C-light	
Color Filter Chromaticity	White	W_X	-0.04	0.3265	+0.04		(1)(4) CF glass C-light	
		W_Y		0.3566				
	Red	R_X		0.6164				
		R_Y		0.3644				
	Green	G_X		0.3613				
		G_Y		0.5636				
	Blue	B_X		0.1454				
		B_Y		0.0926				
Viewing angle	Hor.	Θ_L	CR>10	70	80	--	(1)(4)	
		Θ_R		70	80	--		
	Ver.	Θ_U		70	80	--		
		Θ_D		70	80	--		
Option View Direction	Free							

Optical Specification Reference Notes:

(1) Definition of Viewing Angle: The viewing angle is the angle at which the contrast ratio is greater than 10. The viewing angles are determined for the horizontal or 3,9 o'clock direction and the vertical or 6,12 o'clock direction with respect to the optical axis which is normal to the LCD surface.

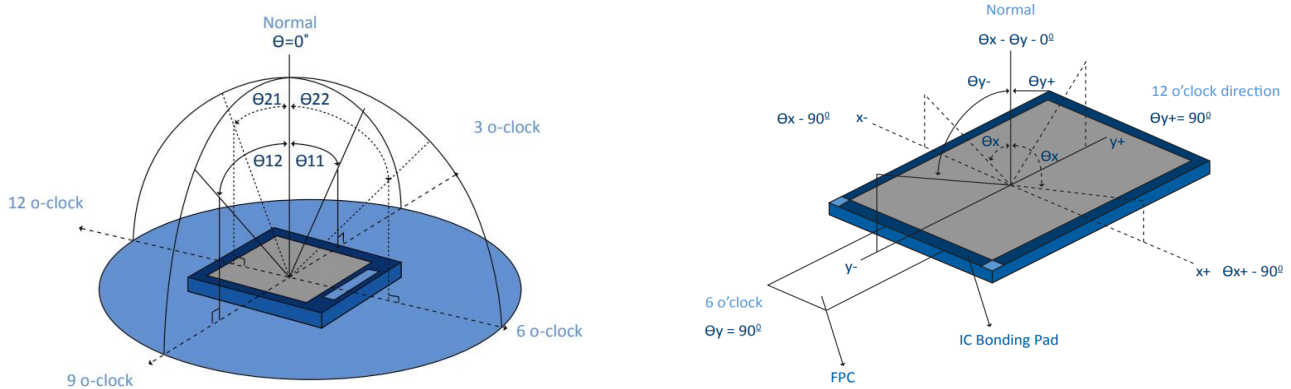

(2) Definition of Contrast Ratio (Cr): measured at the center point of panel. The contrast ratio (Cr) measured on a module, is the ratio between the luminance (Lw) in a full white area (R=G=B=1) and the luminance (Ld) in a dark area (R=G=B=0).

$$Cr = \frac{Lw}{Ld}$$

(3) Definition of transmittance (T%): The transmittance of the panel including the polarizers is measured with electrical driving. The equation for transmittance Tr is:

$$Tr = \frac{I_t}{I_o} \times 100\%$$

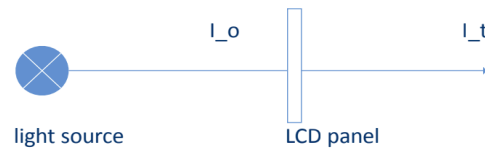

I_o = the brightness of the light source.

I_t = the brightness after panel transmission

(4) Definition of Response Time (T_r , T_f): The rise time 'Tr' is defined as the time for luminance to change from 90% to 10% as a result of a change of the electrical condition. The fall time 'Tf' is defined as the time for luminance to change from 10% to 90% as a result of a change of the electrical condition.

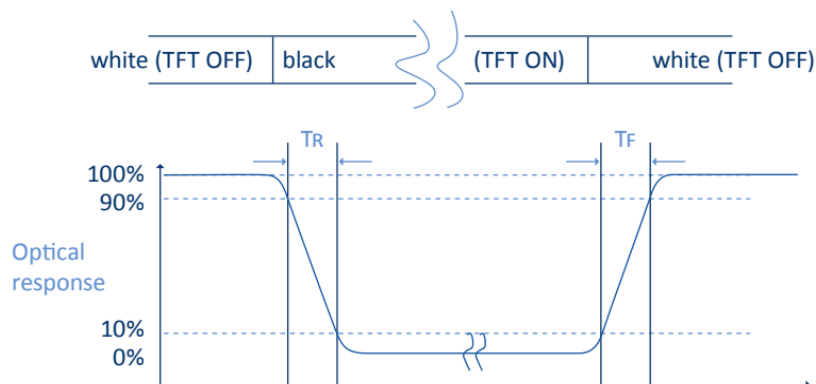

(5) Definition of Color Gamut:

Measuring machine CFT-01. NTSC's Primaries: $R(x,y,Y), G(x,y,Y), B(x,y,Y)$. FPM520 of Westar Display Technologies, INC., which utilized SR-3 for Chromaticity and BM-5A for other optical characteristics. The color chromaticity shall be calculated from the spectral data measured with all pixels first in red, green, blue and white. Measurements shall be made at the center of the panel.

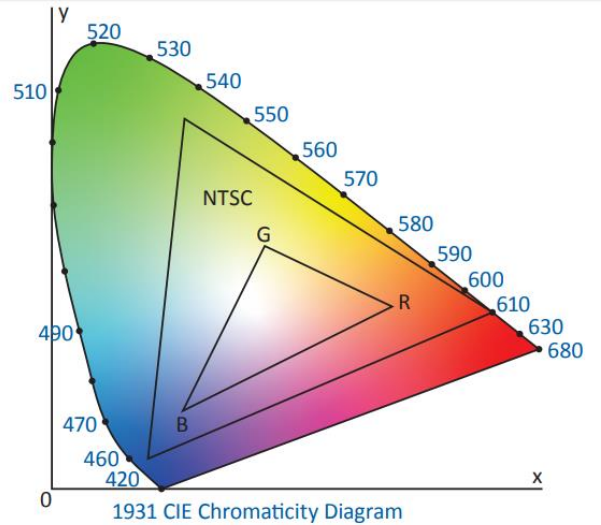
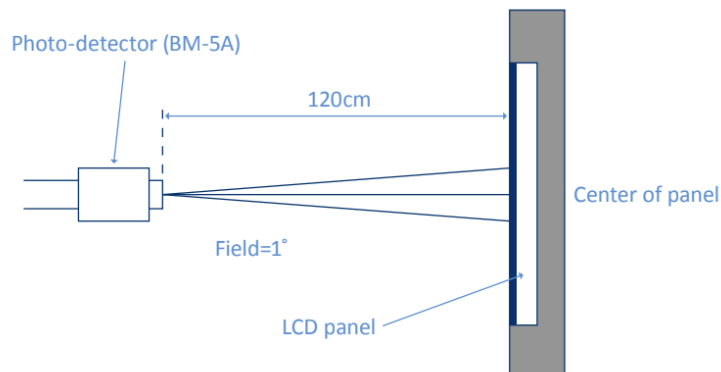
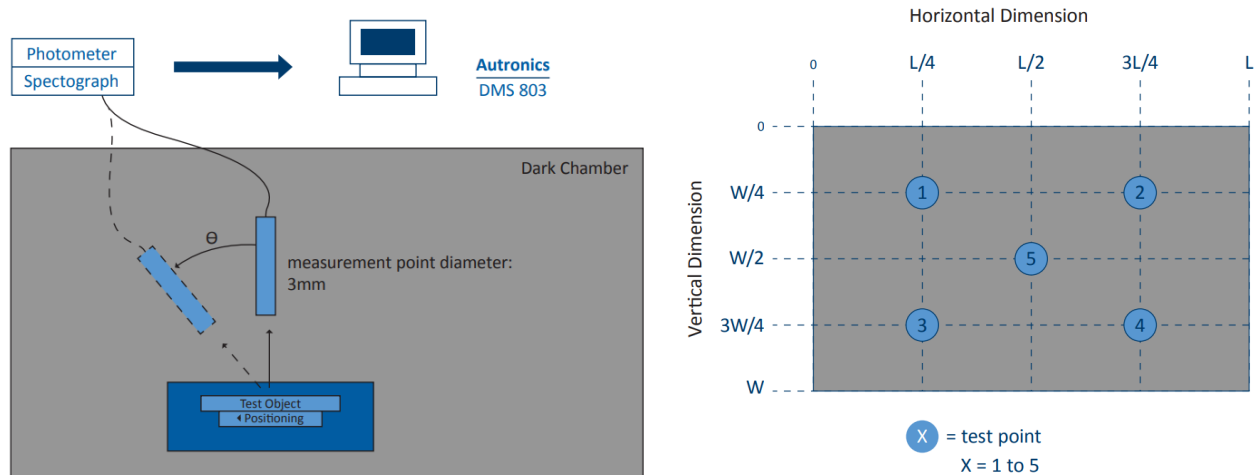

Fig. 1931 CIE chromacity diagram

$$\text{Color gamut: } S = \frac{\text{Area of RGB triangle}}{\text{Area of NTSC triangle}} \times 100\%$$

(6) Definition of Optical Measurement Setup:

The LCD module should be stabilized at a given temperature for 20 minutes to avoid abrupt temperature change during measuring. In order to stabilize the luminance, the measurement should be executed after lighting backlight for 20 minutes.



5. TFT Electrical Characteristics

5.1 Absolute Maximum Rating (Ta=25 °C, VSS=0V)

Characteristics	Symbol	Min	Max	Unit
Digital Supply Voltage	VDD	-0.3	4.0	V
Operating Temperature	TOP	-30	+85	°C
Storage Temperature	TST	-40	+85	°C

NOTE: If the absolute maximum rating of the above parameters is exceeded, even momentarily, the quality of the product may be degraded. Absolute maximum ratings specify the values which the product may be physically damaged if exceeded. Be sure to use the product within the range of the absolute maximum ratings.

5.2 DC Electrical Characteristics

Characteristics	Symbol	Min	Typ.	Max	Unit	Note
Digital Supply Voltage	VDD	3.0	3.3	3.6	V	
Normal Mode Current	IDD	--	20	40	mA	
Level Input Voltage	VIH	0.7VDD	--	VDD	V	
	VIL	GND	--	0.3VDD	V	
Level Output Voltage	VOH	VDD-0.4	--	VDD	V	
	VOL	GND	--	GND+0.4	V	

5.3 LED Backlight Characteristics

Item	Symbol	Min	Typ.	Max	Unit	Note
Forward Current	IF	--	40	--	mA	
Forward Voltage	VF	--	15	--	V	
LCM Luminance	LV	800	850	--	cd/m ²	Note 3
LED lifetime	Hr	--	50000	--	hour	Note1 & 2
Uniformity	AVg	80	--	--	%	Note 3

The back-light system is edge-lighting type with 10 white LEDs.

Note 1: LED lifetime (Hr) can be defined as the time in which it continues to operate under the condition: $T_a=25\pm 3\text{ }^\circ\text{C}$, typical IL value indicated in the above table until the brightness becomes less than 50%.

Note 2: The “LED lifetime” is defined as the module brightness decrease to 50% original brightness at $T_a=25^\circ\text{C}$ and $I_L=8\text{--}40\text{mA}$. The LED lifetime could be decreased if operating I_L is larger than 40mA. The constant current driving method is suggested.

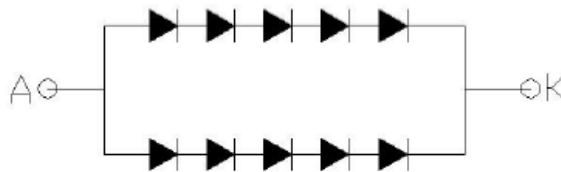

Backlight LED Circuit

Note 3: Luminance Uniformity of these 9 points is defined as below:

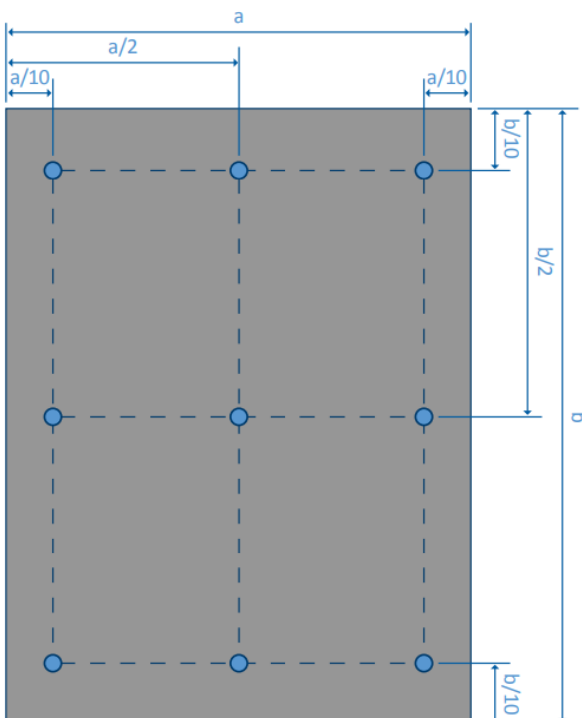

$$\text{Luminance} = \frac{\text{Total Luminance of 9 points}}{9}$$

$$\text{Uniformity} = \frac{\text{minimum luminance in 9 points(1-9)}}{\text{maximum luminance in 9 points(1-9)}}$$

6. TP Feature

6.1. Conditions of use and storage

Item	Condition	Note
Temperature Range For Operation	Humidity: 20%-90% non dew, condensation -20°C- 70°C	In a simple substance
Temperature Range for Storage	Humidity: 20%-90% non dew, condensation -30°C- 80°C	In a simple substance

6.2. Electrical Properties

Item	Condition	Note
Maximum Voltage	DC5V	
Resistance Between Terminals	X direction [film side]: 200-600Ω	
	Y Direction [glass side]: 300-900Ω	
Insulation Resistance	DC25V 20 MΩ or above	Connect x+ -X- and Y+ Y-, apply 25VDC Between X and Y to perform measurements
Chattering	10 msec or below	
Rating	Voltage is DV 5V	

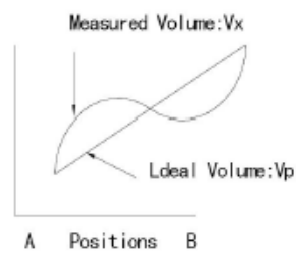
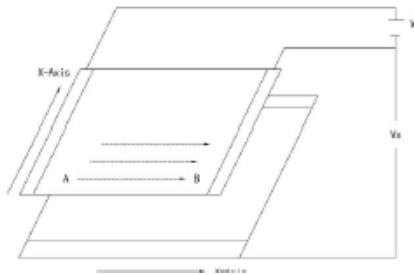

6.3 Mechanical Properties

Item	Performance		Note
Input Method	Stylus or Finger		
Load Upon Operation	Stylus	60-100g or below	Operation and measurement with a pen must be carried out under the following tip condition: stylus pen material: POM (polyacetal) Tip: Diameter 3.0mm SR 0.8mm
	Finger	60-100g or below	Operation and measurement methods simulating a finger must be carried out under the following tip condition: Material: silicon rubber (Hardness : 30°Hs) Tip: diameter 12.0mm, SR 12.5mm
Surface Hardness	Pencil Hardness : 3H or above		Complies with test method JIS K5400.

6.4 Optical Properties

Item	Performance	Note
Total Light Transmittance	80% or above	JIS K7105
Haze	5% or below	JIS K7136
Film Specification	Polished type with hard coated surface	

7. AC Characteristics

7.1. 3-wire Serial Interface (3SPI)

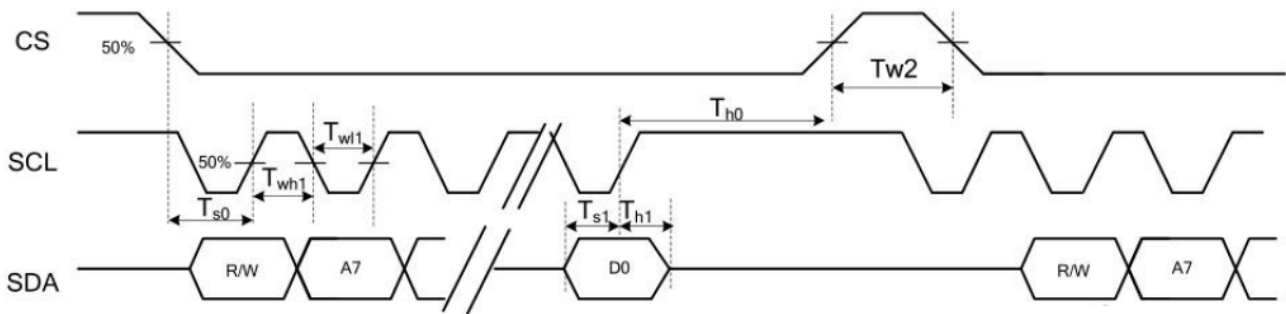

Item	Symbol	Min.	Typ.	Max.	Unit	Conditions
CS Input Setup Time	T_{s0}	50	-	-	ns	
Serial Data Input Setup Time	T_{s1}	50	-	-	ns	
CS Input Hold Time	T_{h0}	50	-	-	ns	
Serial Data Input Hold Time	T_{h1}	50	-	-	ns	
SCL Write Pulse High Width	T_{wh1}	50	-	-	ns	
SCL Write Pulse Low Width	T_{wl1}	50	-	-	ns	
SCL Read Pulse High Width	T_{rh1}	300	-	-	ns	
SCL Read Pulse Low Width	T_{rl1}	300	-	-	ns	
CS Pulse High Width	T_{w2}	400	-	-	ns	

7.2. RGB Data Bus Timing Signals

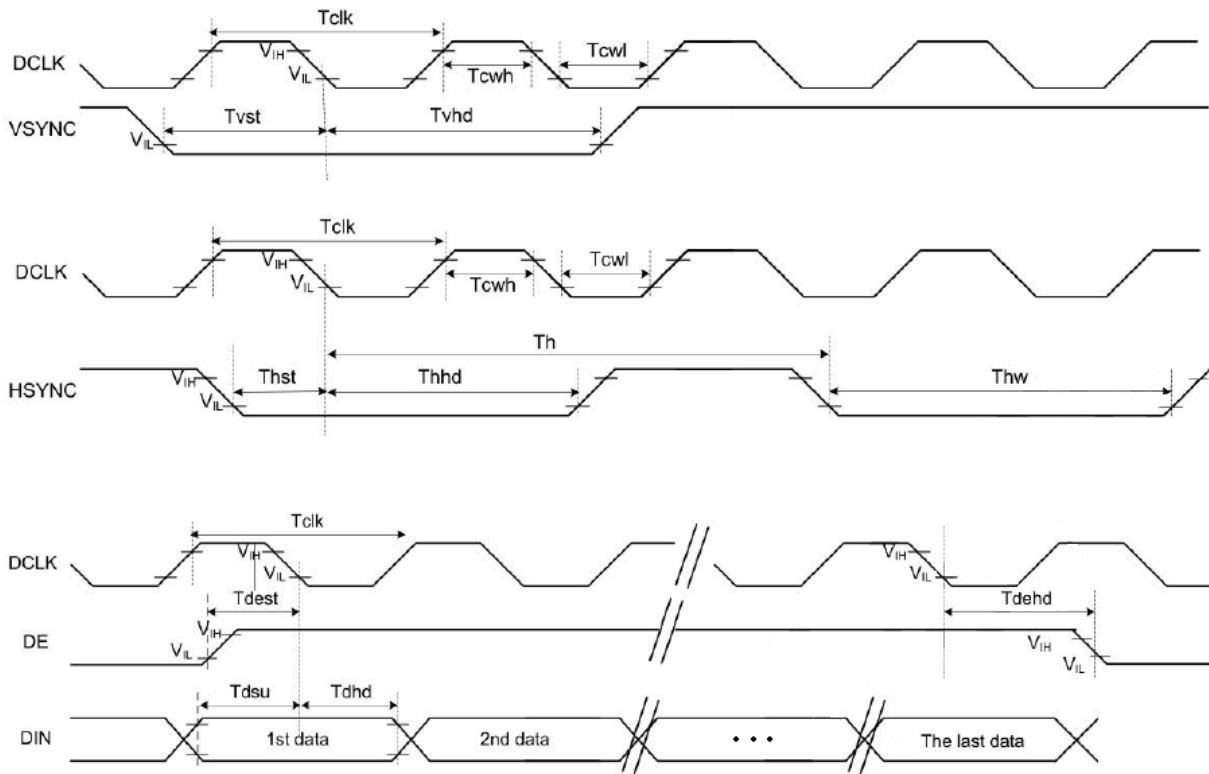

Item	Symbol	Min.	Typ.	Max.	Unit	Conditions
CLK Pulse Duty	T_{clk}	40	50	60	%	
HSYNC Width	T_{hw}	2	-	-	DCLK	
HSYNC Period	T_h	55	60	65	us	
VSYNC Setup Time	T_{vst}	12	-	-	ns	
VSYNC Hold Time	T_{vhd}	12	-	-	ns	
HSYNC Setup Time	T_{hst}	12	-	-	ns	
HSYNC Hold Time	T_{hhd}	12	-	-	ns	
Data Setup Time	T_{dsu}	12	-	-	ns	
Data Hold Time	T_{dhd}	12	-	-	ns	
DE Setup Time	T_{dst}	12	-	-	ns	
DE Hold Time	T_{dhd}	12	-	-	ns	

7.3. RGB SYNC Mode

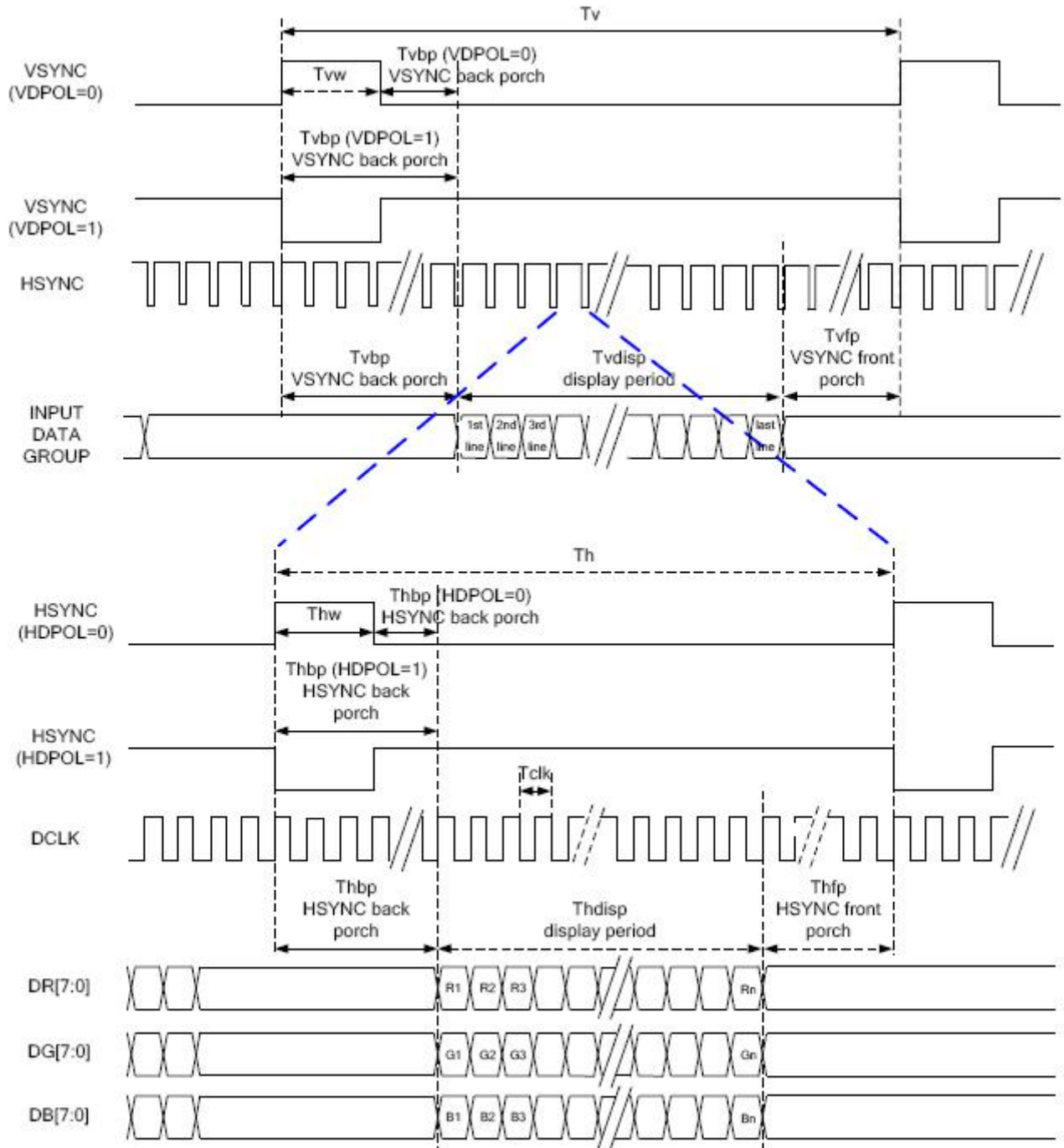

7.4. RGB SYNC-DE Mode

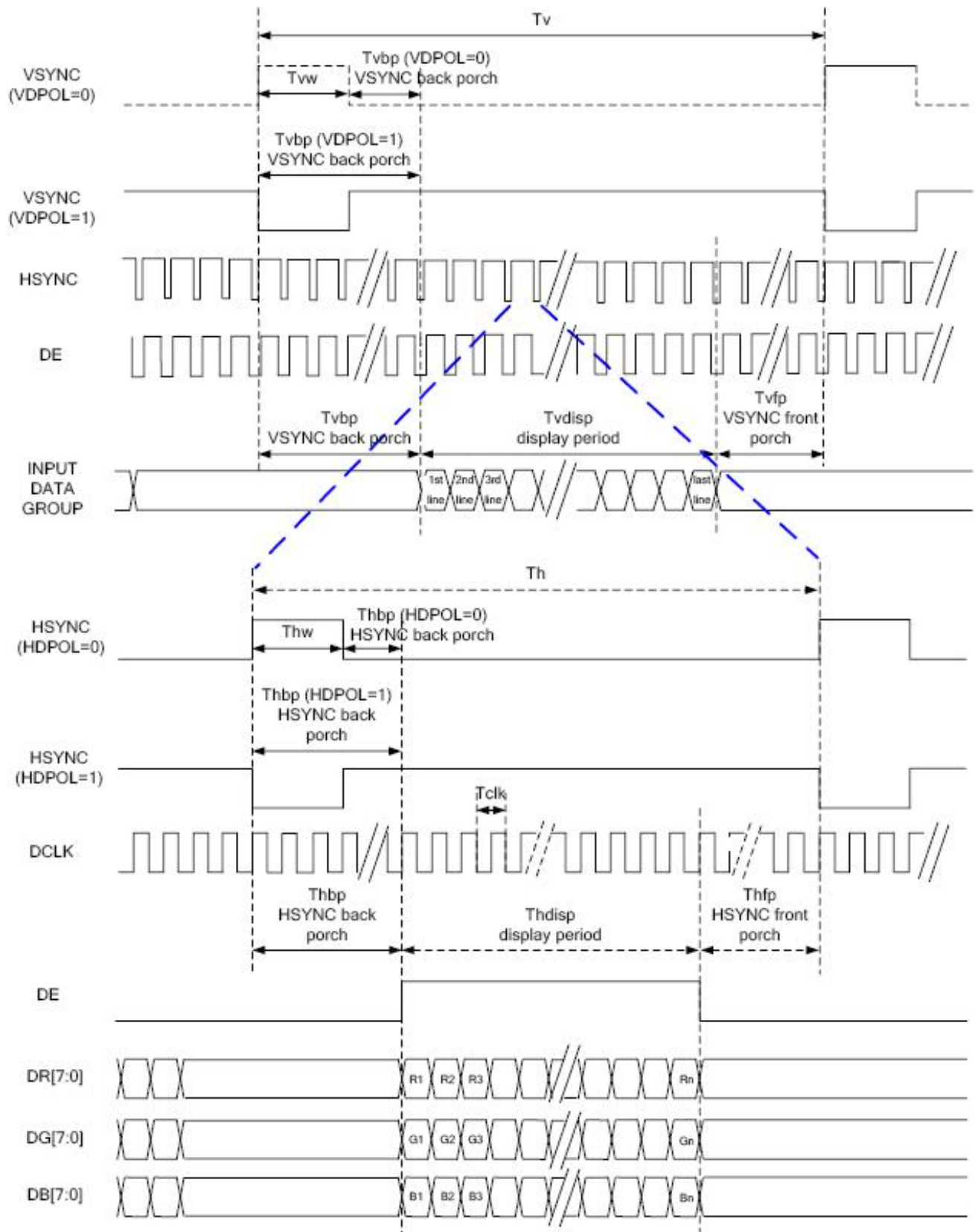

7.5. DE Mode

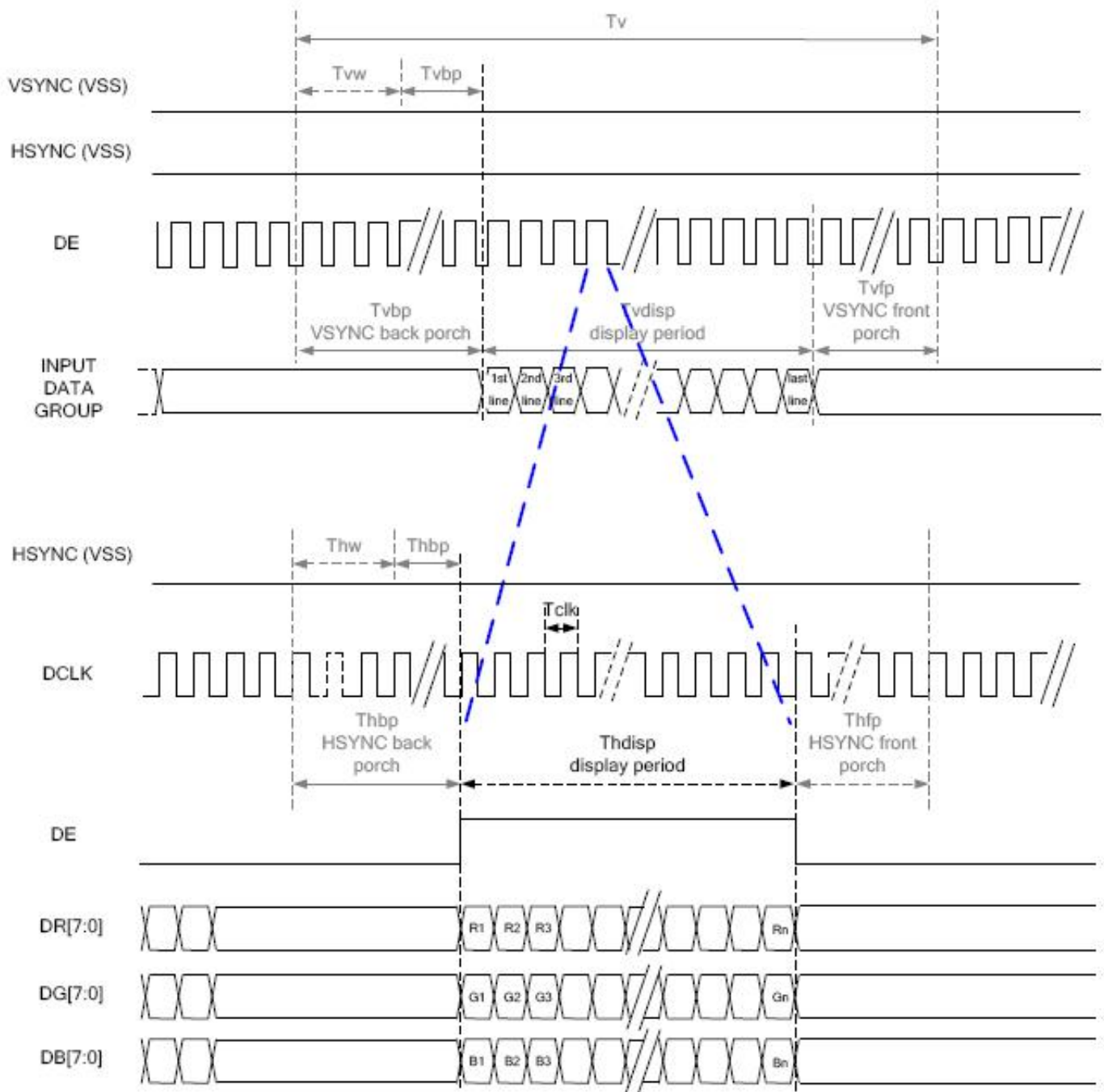

RGB Mode Selection	DCLK	HSYNC	VSYNC	DE
SYNC-DE Mode	Input	Input	Input	Input
SYNC Mode	Input	Input	Input	GND
DE Mode	Input	GND	GND	Input

7.6. 24-bit RGB Timing Table

Item	Symbol	Min.	Typ.	Max.	Unit	Conditions	
DCLK Frequency	Fclk	5	6	8	MHz		
DCLK Period	Tclk	125	167	200	ns		
HSYNC	Period Time	Th	325	371	438	DCLK	
	Display Period	Thdisp	-	320	-	DCLK	
	Back Porch	Thbp	3	43	43	DCLK	H blanking setting
	Front Porch	Thfp	2	8	75	DCLK	
	Pulse Width	Thw	2	4	43	DCLK	
VSYNC	Period Time	Tv	244	260	289	HSYNC	
	Display Period	Tvdisp	-	240	-	HSYNC	
	Back Porch	Tvbp	2	12	12	HSYNC	V blanking setting
	Front Porch	Tvfp	2	8	37	HSYNC	
	Pulse Width	Tvw	2	4	12	HSYNC	

8. Cautions and Handling Precautions

8.1 Handling and Operating the Module

1. When the module is assembled, it should be attached to the system firmly. Do not warp or twist the module during assembly work.
2. Protect the module from physical shock or any force. In addition to damage, this may cause improper operation or damage to the module and back-light unit.
3. Note that polarizer is very fragile and could be easily damaged. Do not press or scratch the surface.
4. Do not allow drops of water or chemicals to remain on the display surface. If you have the droplets for a long time, staining and discoloration may occur.
5. If the surface of the polarizer is dirty, clean it using some absorbent cotton or soft cloth.
6. The desirable cleaners are water, IPA (Isopropyl Alcohol) or Hexane. Do not use ketene type materials (ex. Acetone), Ethyl alcohol, Toluene, Ethyl acid or Methyl chloride. It might permanent damage to the polarizer due to chemical reaction.
7. If the liquid crystal material leaks from the panel, it should be kept away from the eyes or mouth. In case of contact with hands, legs, or clothes, it must be washed away thoroughly with soap.
8. Protect the module from static; it may cause damage to the CMOS ICs.
9. Use fingerstalls with soft gloves in order to keep display clean during the incoming inspection and assembly process.
10. Do not disassemble the module.
11. Protection film for polarizer on the module shall be slowly peeled off just before use so that the electrostatic charge can be minimized.
12. Pins of I/F connector shall not be touched directly with bare hands.
13. Do not connect, disconnect the module in the “Power ON” condition.
14. Power supply should always be turned on/off by the item Power On Sequence & Power Off Sequence.

8.2 Storage and Transportation

1. Do not leave the panel in high temperature, and high humidity for a long time. It is highly recommended to store the module with temperature from 0 to 35 °C and relative humidity of less than 70%
2. Do not store the TFT-LCD module in direct sunlight.
3. The module shall be stored in a dark place. When storing the modules for a long time, be sure to adopt effective measures for protecting the modules from strong ultraviolet radiation, sunlight, or fluorescent light.
4. It is recommended that the modules should be stored under a condition where no condensation is allowed. Formation of dewdrops may cause an abnormal operation or a failure of the module. In particular, the greatest possible care should be taken to prevent any module from being operated where condensation has occurred inside.
5. This panel has its circuitry FPC on the bottom side and should be handled carefully in order not to be stressed.