

Data sheet | Item number: 769-110/000-039

1-conductor female connector; CAGE CLAMP®; 4 mm²; Pin spacing 5 mm;
10-pole; coding finger; 4,00 mm²; gray/blue/green-yellow

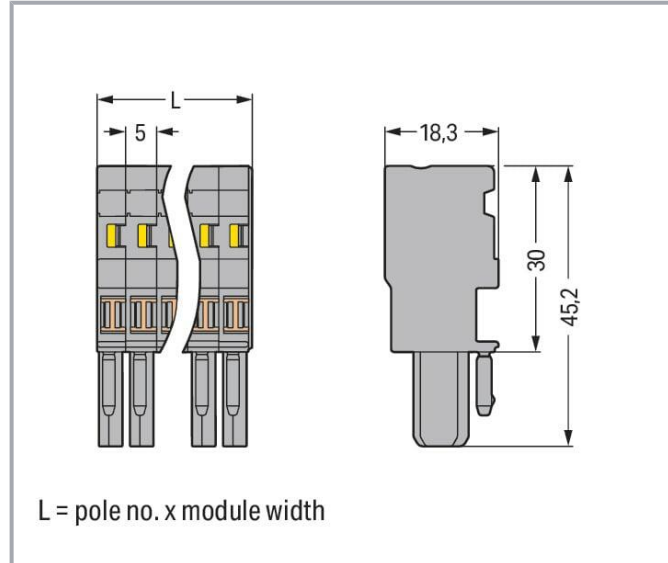

www.wago.com/769-110/000-039

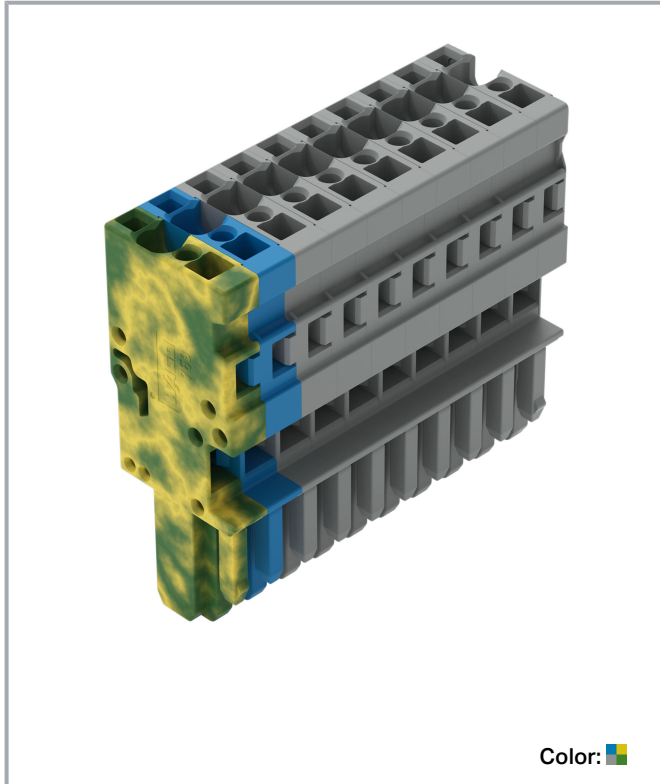

Data

Notes

Safety information

According to EN 61984, pluggable connectors without current interrupting capacity must not be mated or unmated when live or under load.

Electrical data

Ratings per IEC/EN

| Ratings per | IEC/EN 61984 |
|-------------------------------|--------------|
| Nominal voltage (III/3) | 500 V |
| Rated impulse voltage (III/3) | 6 kV |
| Rated current | 32 A |

Subject to changes. Please also observe the further product documentation!

WAGO GmbH & Co. KG
Hansastr. 27
32423 Minden
Phone: +49571 887-0 | Fax: +49571 887-169
Email: info.de@wago.com | Web: www.wago.com

Do you have any questions about our products?
We are always happy to take your call at +49 (571) 887-44222.



Legend (ratings)

(III / 3) $\hat{=}$ Overvoltage category III / Pollution degree 3

Connection data

| | |
|----------------------------|----|
| Connection points | 10 |
| Total number of potentials | 10 |

Connection 1

| | |
|---------------------------------|--|
| Connection technology | CAGE CLAMP® |
| Actuation type | Operating tool |
| Connectable conductor materials | Copper |
| Nominal cross-section | 4 mm ² / 12 AWG |
| Solid conductor | 0.08 ... 4 mm ² / 28 ... 12 AWG |
| Fine-stranded conductor | 0.08 ... 4 mm ² / 28 ... 12 AWG |
| Strip length | 8 ... 9 mm / 0.31 ... 0.35 inches |
| Pole number | 10 |
| Wiring direction | Front-entry wiring |

Physical data

| | |
|--------------|-----------------------|
| Width | 50 mm / 1.969 inches |
| Height | 45.2 mm / 1.78 inches |
| Depth | 18.3 mm / 0.72 inches |
| Module width | 5 mm / 0.197 inches |

Mechanical Data

| | |
|--|--------------|
| Variable coding | Yes |
| Direct ground contact to DIN-rail/drilled hole/housing | No |
| Marking level | Side marking |
| Anti-rotation protection | Yes |

Plug-in connection

| | |
|--------------------------------------|-------------------------|
| Contact type (pluggable connector) | Female connector/socket |
| Connector (connection type) | for conductor |
| Mismating protection | No |
| Plugging without loss of pin spacing | Yes |

Subject to changes. Please also observe the further product documentation!



Material Data

Note (material data)

Information on material specifications can be found here

| | |
|-----------------------------|------------------------|
| Color | gray/blue/green-yellow |
| Material group | I |
| Insulation material | Polyamide (PA66) |
| Flammability class per UL94 | V0 |
| Fire load | 0.622 MJ |
| Halogen-free | Yes |
| Weight | 32.4 g |

Environmental requirements

| | |
|----------------------------------|-----------------|
| Processing temperature | -35 ... +85 °C |
| Continuous operating temperature | -60 ... +105 °C |

Commercial data

| | |
|-----------------------|---------------|
| eCl@ss 10.0 | 27-14-11-06 |
| eCl@ss 9.0 | 27-14-11-06 |
| ETIM 8.0 | EC001284 |
| ETIM 7.0 | EC001284 |
| PU (SPU) | 25 pcs |
| Packaging type | box |
| Country of origin | DE |
| GTIN | 4050821653509 |
| Customs tariff number | 85366990990 |

Environmental Product Compliance

| | |
|------------------------|-------------------------|
| RoHS Compliance Status | Compliant, No Exemption |
|------------------------|-------------------------|

Approvals / Certificates

General approvals

| Logo | Approval | Additional Approval Text | Certificate name |
|------|--|--------------------------|------------------|
| | CSA DEKRA Certification B.V. | C22.2 No. 158 | 1101144 |

Subject to changes. Please also observe the further product documentation!













| | | |
|--------------------------------|---------|---------|
| UL | UL 1977 | E 45171 |
| Underwriters Laboratories Inc. | | |



| | | |
|--------------------------------|---------|--------|
| UR | UL 1059 | E45172 |
| Underwriters Laboratories Inc. | | |

Optional accessories

Ferrule

| Ferrule | | |
|---|--|--|
|  | Item no.: 216-101 Ferrule; Sleeve for 0.5 mm ² / AWG 22; uninsulated; electro-tin plated; silver-colored | www.wago.com/216-101 |
|  | Item no.: 216-104 Ferrule; Sleeve for 1.5 mm ² / AWG 16; uninsulated; electro-tin plated; silver-colored | www.wago.com/216-104 |
|  | Item no.: 216-102 Ferrule; Sleeve for 0.75 mm ² / AWG 20; uninsulated; electro-tin plated; silver-colored | www.wago.com/216-102 |
|  | Item no.: 216-103 Ferrule; Sleeve for 1 mm ² / AWG 18; uninsulated; electro-tin plated | www.wago.com/216-103 |
|  | Item no.: 216-203 Ferrule; Sleeve for 1 mm ² / AWG 18; insulated; electro-tin plated; red | www.wago.com/216-203 |
|  | Item no.: 216-206 Ferrule; Sleeve for 2.5 mm ² / AWG 14; insulated; electro-tin plated; blue | www.wago.com/216-206 |
|  | Item no.: 216-202 Ferrule; Sleeve for 0.75 mm ² / 18 AWG; insulated; electro-tin plated; gray | www.wago.com/216-202 |
|  | Item no.: 216-204 Ferrule; Sleeve for 1.5 mm ² / AWG 16; insulated; electro-tin plated; black | www.wago.com/216-204 |
|  | Item no.: 216-201 Ferrule; Sleeve for 0.5 mm ² / 20 AWG; insulated; electro-tin plated; white | www.wago.com/216-201 |
|  | Item no.: 216-301 Ferrule; Sleeve for 0.25 mm ² / AWG 24; insulated; electro-tin plated; yellow | www.wago.com/216-301 |
|  | Item no.: 216-302 Ferrule; Sleeve for 0.34 mm ² / 22 AWG; insulated; electro-tin plated; light turquoise | www.wago.com/216-302 |

Subject to changes. Please also observe the further product documentation!

WAGO GmbH & Co. KG
 Hansastr. 27
 32423 Minden
 Phone: +49571 887-0 | Fax: +49571 887-169
 Email: info.de@wago.com | Web: www.wago.com

Do you have any questions about our products?
 We are always happy to take your call at +49 (571) 887-44222.

Protective warning marker

Cover

**Item no.: 280-415**

Protective warning marker; for 5 terminal blocks; with high-voltage symbol, black; yellow

www.wago.com/280-415

Cover

Cover

**Item no.: 769-436**

Jumper cover; for 1-conductor female plugs; for 5 poles; gray

www.wago.com/769-436

Locking levers

Locking system

**Item no.: 769-430**

Locking lever; for female connectors; 1 part; Pin spacing 5 mm; 2-pole; gray

www.wago.com/769-430**Item no.: 769-431**

Locking lever; for female connectors; 1 part; Pin spacing 5 mm; 2-pole; orange

www.wago.com/769-431

Testing and measuring

Testing accessories

**Item no.: 210-136**

Test plug; 2 mm Ø; with 500 mm cable; red

www.wago.com/210-136

Insulation stop

Insulation stop

**Item no.: 769-470**Insulation stop; 0.08 - 0.2 mm² "s" (0.14 mm² "f-st"); 5 pieces/strip; whitewww.wago.com/769-470**Item no.: 769-471**Insulation stop; 0.25 - 0.5 mm²; 5 pieces/strip; light graywww.wago.com/769-471**Item no.: 769-472**Insulation stop; 0.75 - 1 mm²; 5 pieces/strip; dark graywww.wago.com/769-472

Strain relief

Strain relief

**Item no.: 769-1610**

Strain relief housing; for female and male connectors; 2 parts; Pin spacing 5 mm; 10-pole; gray

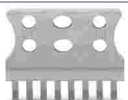
www.wago.com/769-1610**Item no.: 769-414**

Strain relief plate; for female and male connectors; 1 part; Pin spacing 5 mm; 10- to 15-pole; gray

www.wago.com/769-414

Subject to changes. Please also observe the further product documentation!

WAGO GmbH & Co. KG

Hansastr. 27

32423 Minden

Phone: +49571 887-0 | Fax: +49571 887-169

Email: info.de@wago.com | Web: www.wago.com

Do you have any questions about our products?

We are always happy to take your call at +49 (571) 887-44222.

Jumpers

Jumper



Item no.: 769-402
Jumper; insulated; gray

www.wago.com/769-402

Tool

Operating tool



Item no.: 210-490
Operating tool

www.wago.com/210-490



Item no.: 769-434
Operating tool; made of insulating material; 1-way; loose; white

www.wago.com/769-434

Marking accessories

Marking strip



Item no.: 210-831
Marking strips; on reel; 2.3 mm wide; plain; Self-adhesive; white

www.wago.com/210-831



Item no.: 210-834
Marking strips; on reel; 5 mm wide; plain; Self-adhesive; white

www.wago.com/210-834



Item no.: 210-832
Marking strips; on reel; 3 mm wide; plain; Self-adhesive; white

www.wago.com/210-832

Label



Item no.: 210-805
Labels; for Smart Printer; permanent adhesive; 6 x 15 mm; white

www.wago.com/210-805



Item no.: 210-805/000-002
Labels; for Smart Printer; permanent adhesive; 6 x 15 mm; yellow

www.wago.com/210-805/000-002

Marker



Item no.: 2009-145
Mini-WSB Inline; for Smart Printer; 1700 pieces on roll; stretchable 5 - 5.2 mm; plain; snap-on type; white

www.wago.com/2009-145



Item no.: 248-501
Mini-WSB marking card; as card; not stretchable; plain; snap-on type; white

www.wago.com/248-501

Downloads

Documentation

Bid Text

769-110/000-039

2019 Feb 19

xml

Download

Subject to changes. Please also observe the further product documentation!

WAGO GmbH & Co. KG

Hansastr. 27

32423 Minden

Phone: +49571 887-0 | Fax: +49571 887-169

Email: info.de@wago.com | Web: www.wago.com

Do you have any questions about our products?

We are always happy to take your call at +49 (571) 887-44222.



| | | | | |
|-----------------|------------|-----|---------|----------|
| X81 - Datei | | | 3.3 kB | |
| 769-110/000-039 | 2017 Oct 4 | doc | | Download |
| doc - Datei | | | 26.6 kB | |

Additional Information

| | | | | |
|------------------------|--|-----|--------|----------|
| Technical Section | | pdf | | Download |
| Technical explanations | | | 2.2 MB | |

CAD/CAE-Data

CAE data

| | | | | |
|-----------------------------------|--|-----|--|----------|
| EPLAN Data Portal 769-110/000-039 | | URL | | Download |
| WSCAD Universe 769-110/000-039 | | URL | | Download |
| WSCAD Universe 769-110/000-039 | | URL | | Download |
| EPLAN Data Portal 769-110/000-039 | | URL | | Download |

Environmental Product Compliance

Compliance Search

| | | | | |
|--|--|-----|--|----------|
| Environmental Product Compliance 769-110/000-039 | | URL | | Download |
| 1-conductor female connector; CAGE CLAMP®; 4 mm²; Pin spacing 5 mm; 10-pole; coding finger; 4,00 mm²; gray/blue/green-yellow | | | | |

Installation Notes

Conductor termination

Subject to changes. Please also observe the further product documentation!

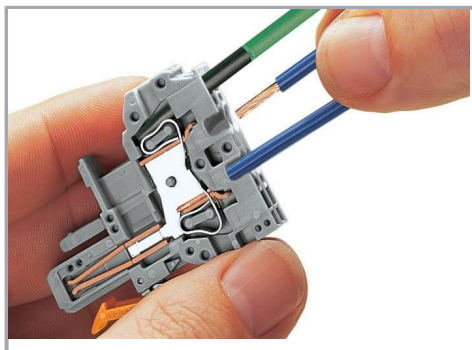

CAGE CLAMP® connection

Female plug: Inserting/removing a conductor via operating tool.

Operation 90° to conductor is also possible.

With ferruled conductors, it is necessary to use a terminal block one size smaller than the conductor's nominal cross-section.

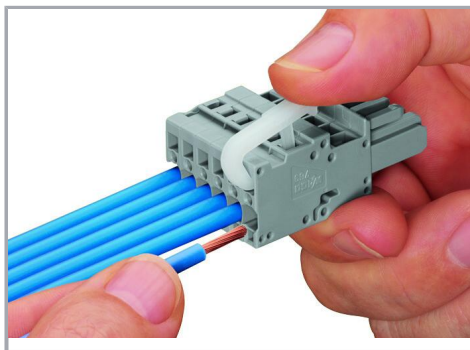

Operating lever

Inserting a conductor – side-entry wiring (example shows a female plug).

Subject to changes. Please also observe the further product documentation!

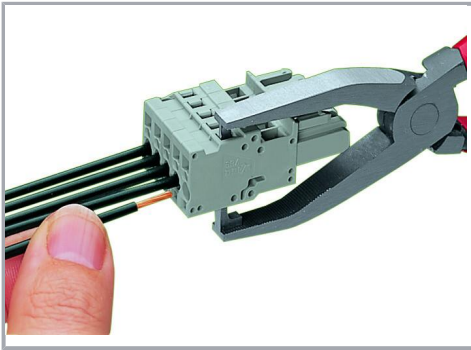

Operating tool

Inserting a conductor – side-entry wiring
(example shows a female plug).

With ferruled conductors, it is necessary to
use a terminal block one size smaller than the
conductor's nominal cross-section.

Commoning

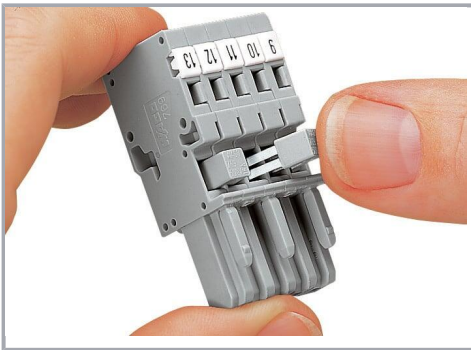

Commoning 1-conductor female plugs via
miniature adjacent jumpers.

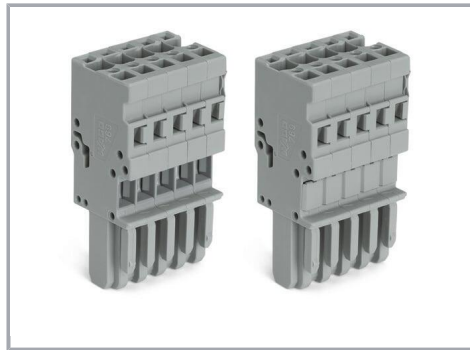

Jumper cover for 1-conductor female plugs

Coding

Subject to changes. Please also observe the further product documentation!



Coding a female plug by removing coding finger(s) via cutting tool. Do not remove the first and last coding fingers or use an additional locking lever.

Locking system

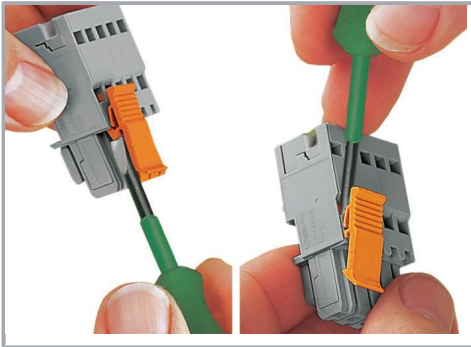

Locking/releasing a lever.

Strain relief

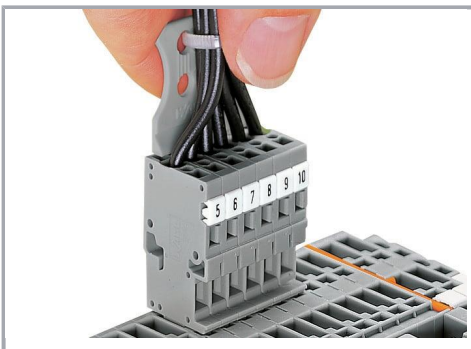

Removing a female plug via conductor bundle provided with strain relief plate.

Subject to changes. Please also observe the further product documentation!

Marking

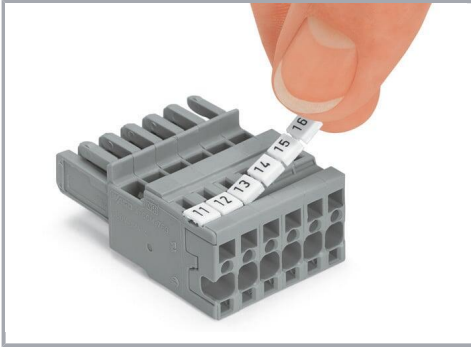

Labeling a female plug with CAGE CLAMP® connection via Mini-WSB Quick Markers.

Product family

X-COM

[Show all products from the family](#)

Subject to changes. Please also observe the further product documentation!