

Specification Sheet

Part Number: 151-02032

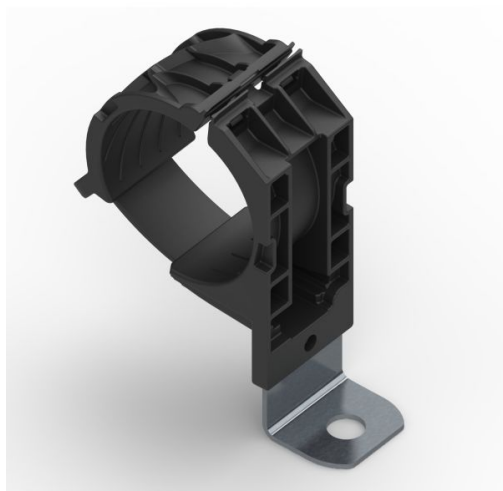

Ratchet P-Clamp, 1.38" - 2.01" Bundle Dia, 90° Short, .26" Hole Dia, PA66HIRHSUV/SS304, Black, 160/ctn

Article Number

151-02032

Type

RCD90SM6SS

Color

Black (BK)

Features & Benefits

- One-piece ratchet closure design allows for easy installation during pre- or final assembly.
- Four sizes and multiple configurations handle a wide range of diameters and applications, reducing part inventory.
- Clamp interior is designed to guide and center bundle to reduce pinching.
- Easy release feature allows for quick adjustments and maintenance.
- Stainless steel mounting plate tolerates high torque mounting, resists galvanic corrosion with dissimilar metals, and harsh chemicals.

Quantity Per

carton

Product Description

The Ratchet P-Clamp family offers versatility when managing wires, cables and hoses. The robust design and durable materials make it ideal for heavy duty applications, both indoors and out. The one-piece adjustable clamp can be closed by hand to the desired diameter. The release feature provides easy and nondestructive removal of cables simply by using a flat-head screwdriver. This nondestructive release allows the clamp to be reused without removing or replacing any bolts or screws. The Ratchet P-Clamp is offered in four sizes and multiple mounting configurations.

Short Description

Ratchet P-Clamp, 1.38" - 2.01" Bundle Dia, 90° Short, .26" Hole Dia, PA66HIRHSUV/SS304, Black, 160/ctn

Global Part Name

RCD90SM6SS-PA66HIRHSUV/SS304-BK

Minimum Tensile Strength (Imperial)

100.0

Minimum Tensile Strength (Metric)

445.0

Length L (Imperial)

6.58

Length L (Metric)

167.2

Fixation Method

Screw Mounting

Variant

Short

Width W (Imperial)

1.37

Width W (Metric)

34.9

Bundle Diameter Min (Imperial)

1.42

Bundle Diameter Min (Metric)

36.0

Bundle Diameter Max (Imperial)

2.0

Bundle Diameter Max (Metric)	51.0
Cable Tie Width Max (Imperial)	0.52
Cable Tie Width Max (Metric)	13.2
Mounting Hole Diameter D (Imperial)	0.256
Mounting Hole Diameter D (Metric)	6.5 mm
Mounting Hole Diameter D Max (Metric)	6.5
Stud Diameter (Metric)	M6
Mounting Hole Centers (Imperial)	1.67
Material	Stainless Steel (SS304) Polyamide 6.6 high impact modified, heat and UV stabilized (PA66HIRHSUV)
Material Shortcut	SS304 PA66HIRHSUV
Flammability	UL 94 HB
UV Resistant (Yes/No)	Yes
Operating Temperature (Metric)	-40°F to +257°F (-40°C to +125°C)
ROHS Complaint	Yes
UL Listed (US and Canada)	Yes

UL Listed (US)

Yes

Package Quantity(Imperial)

160

Package Quantity (Metric)

160

Customs Number

3926909988