

## 1500 – 4000 MHz High Linearity LNA

### Device Features

- Operated at 3.0V and 5.0V
- 35.5 dBm Output IP3 at 0dBm/tone at 3500MHz
- 16.4 dB Gain at 3500 MHz
- 20.1 dBm P1dB at 3500MHz
- 0.67 dB NF at 3500MHz
- Fast shut down to support TDD systems
- Green/RoHS2 Compliant DFN 8L 2x2 Package

### Product Description

BeRex's BLB03 is a high linearity LNA, based on GaAs material with E-pHEMT process and packaged in a RoHS2-compliant DFN 8L 2x2 mm<sup>2</sup> Surface mount package. It is designed for use where low noise and high linearity are required and features low noise and high OIP3 at Frequency range of 1.5~4.0GHz. It can be used in fast shutdown switching speed for TD-LTE application. All devices are 100% RF/DC tested and classified as HBM ESD Class 1C.

### Applications

- Base station Infrastructure
- Commercial/Industrial/Military wireless system
- TDD or FDD LTE system/5G NR

### Applications Circuit

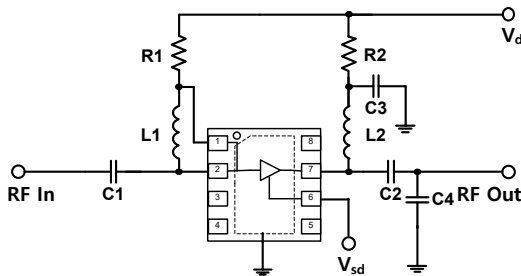

BOM	5V Value	3V Value	5V Value	3V Value
Freq	1.5~3G	1.5~3G	3~4G	3~4G
C1,C2,C3	20pF	20pF	20pF	20pF
C4	N/A	N/A	0.3pF	0.3pF
R1	9.1Kohm	6.8Kohm	9.1Kohm	6.8Kohm
R2	3 ohm	3 ohm	3 ohm	3 ohm
L1	15nH	15nH	15nH	15nH
L2	8.2nH	8.2nH	8.2nH	8.2nH

### Part Marking (XX:Wafer number)

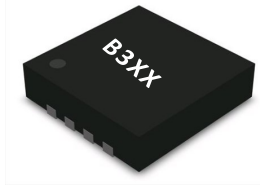

### Electrical Specifications

Device performance \_ measured on a BeRex evaluation board at 25°C, Vd=5V, 50 Ω system.

Parameter	Conditions	Min	Typ	Max	Unit
Operational Frequency Range		1500		4000	MHz
Test Frequency			3500		MHz
Gain		14.9	16.4		dB
Input Return Loss			-12.9		dB
Output Return Loss			-10.5		dB
Output IP3	0 dBm / tone , Δf=1 MHz	32.5	35.5		dBm
Output P1dB		19.1	20.1		dBm
Noise Figure			0.83	1.03	dB

\* Noise Figure data has input trace loss de-embedded.

Device performance \_ measured on a BeRex evaluation board at 25°C, Vd=3V, 50 Ω system.

Parameter	Conditions	Min	Typ	Max	Unit
Operational Frequency Range		1500		4000	MHz
Test Frequency			3500		MHz
Gain		14.2	15.7		dB
Input Return Loss			-10.6		dB
Output Return Loss			-11.2		dB
Output IP3	0 dBm / tone , Δf=1 MHz	27.8	30.8		dBm
Output P1dB		14.8	15.8		dBm
Noise Figure			0.82	1.02	dB

\* Noise Figure data has input trace loss de-embedded.

### Recommended Operating Conditions<sup>1</sup>

Parameter	Min	Typ	Max	Unit
Bandwidth	1500		4000	MHz
I <sub>d</sub> @ (V <sub>d</sub> = 5.0V)	46	57	68	mA
I <sub>d</sub> @ (V <sub>d</sub> = 3.0V)	27	34	41	mA
V <sub>d</sub>	3	5	5.25	V
dG/dT		-0.008		dB/°C
R <sub>TH</sub>		34.1		°C/W
Operating Case Temperature	-40		+105	°C

Electrical specifications are measured at specified test conditions.

Specifications are not guaranteed over all recommended operating conditions.

**1500 – 4000 MHz High Linearity LNA**
**Recommended Operating Conditions<sup>2</sup>**

Parameter	Condition	Min.	Typical	Max.	Unit
Shutdown Control	On state	0		0.9	V
	Off state(shutdown)	1.17		V <sub>DD</sub>	V
Current, IDD	On state 5V	46	57	68	mA
	On state 3V	27	34	41	mA
	Off state(shutdown)	5	7	9	mA
Shutdown pin current, I <sub>sd</sub>	1.17V ≤ V <sub>sd</sub> < V <sub>DD</sub>		150		uA
Switching Time	Rise time(10% to 90%)		140		ns
	Fall time(90% to 10%)		40		ns

**Absolute Maximum Ratings**

Parameter	Rating	Unit
Storage Temperature	-55 to +155	°C
Junction Temperature	+160	°C
Supply Voltage	+6	V
Supply Current	120	mA
Input RF Power	21	dBm

Operation of this device above any of these parameters may result in permanent damage.

**Typical Performance (V<sub>d</sub>=5.0V, I<sub>d</sub>=57mA, T=25°C)**

Parameter	Frequency				Unit
	1850	2140	2650	3500	
<b>V<sub>d</sub> = 5V</b>	<b>1850</b>	<b>2140</b>	<b>2650</b>	<b>3500</b>	<b>MHz</b>
Gain	20.3	19.5	18	16.4	dB
S11	-14.4	-15.1	-15.1	-12.9	dB
S22	-6.8	-7.3	-7.8	-10.5	dB
OIP3	33.9	34.3	35.8	35.5	dBm
P1dB	20.9	21.2	21	20.1	dBm
Noise Figure	0.32	0.36	0.45	0.83	dB

**Typical Performance (V<sub>d</sub>=3.0V, I<sub>d</sub>=34mA, T=25°C)**

Parameter	Frequency				Unit
	1850	2140	2650	3500	
<b>V<sub>d</sub> = 3V</b>	<b>1850</b>	<b>2140</b>	<b>2650</b>	<b>3500</b>	<b>MHz</b>
Gain	19.5	18.6	17	15.7	dB
S11	-11.9	-12.7	-12.7	-10.6	dB
S22	-7.0	-7.4	-7.8	-11.2	dB
OIP3	29.6	29.6	30.3	30.8	dBm
P1dB	16.5	16.8	16.6	15.8	dBm
Noise Figure	0.31	0.38	0.48	0.82	dB

## 1500 – 4000 MHz High Linearity LNA

### V-I Characteristics

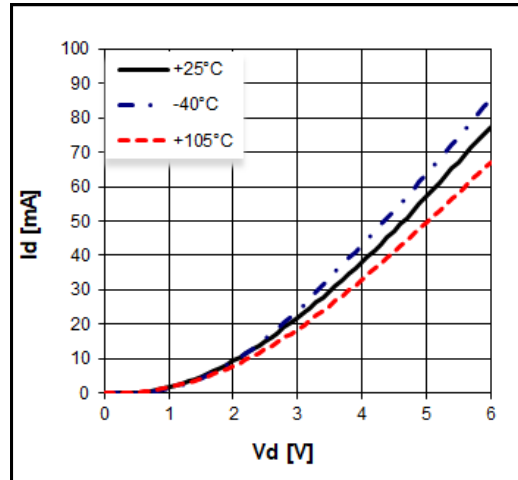

### Pin Configuration

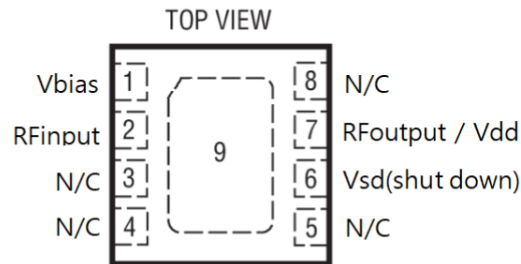

DC PACKAGE  
8-LEAD (2mm × 2mm) PLASTIC DFN  
EXPOSED PAD (PIN 9) IS GND, MUST BE SOLDERED TO PCB

### Evaluation Board

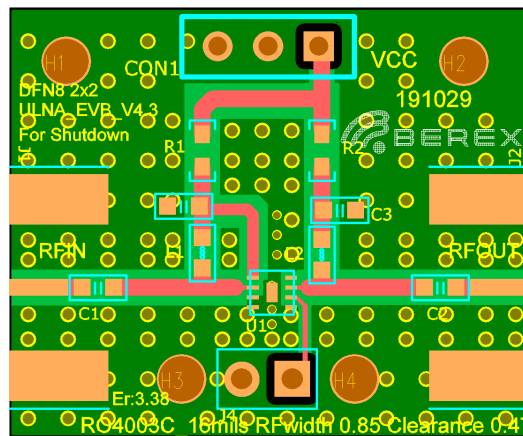

\*Dielectric constant \_ 4.2 \*RF pattern width 24mil \*16mil thick RO4003 PCB

## 1500 – 4000 MHz High Linearity LNA

### Typical Device Data

S-parameters ( $V_d=5.0V$ ,  $I_d=57mA$ ,  $T=25^\circ C$ )

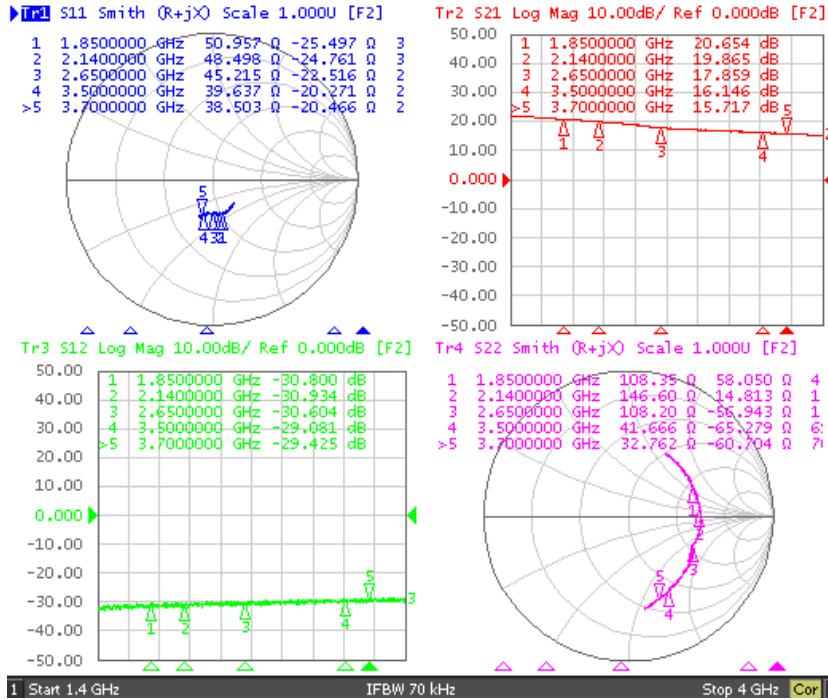

S-parameters ( $V_d=3.0V$ ,  $I_d=34mA$ ,  $T=25^\circ C$ )

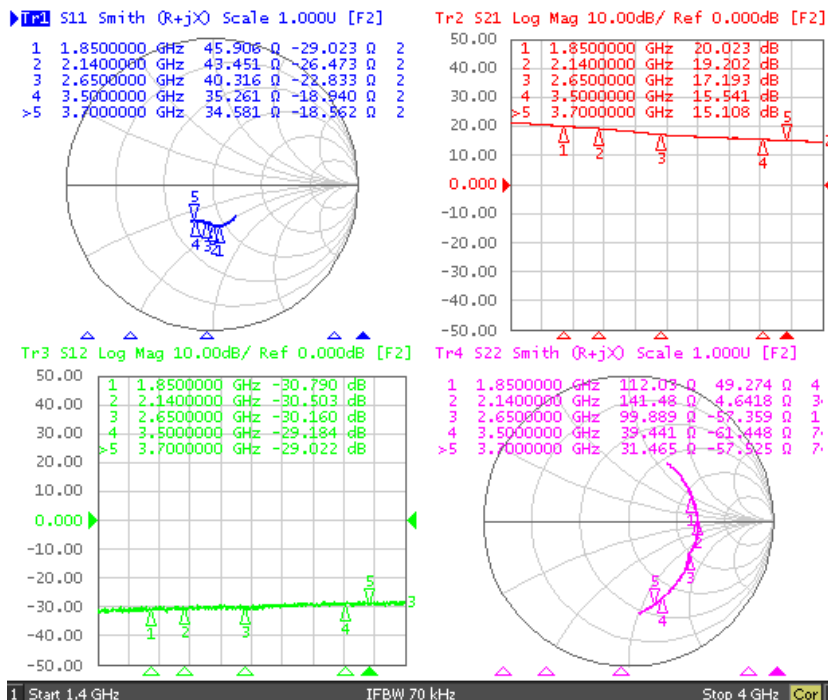

# 1500 – 4000 MHz High Linearity LNA

## S-Parameter

(Vd=5.0V, Id = 57mA, T = 25 °C, calibrated to device leads)

Freq [MHz]	S11 Mag	S11 Ang	S21 Mag	S21 Ang	S12 Mag	S12 Ang	S22 Mag	S22 Ang
1400	0.22	-48.10	12.57	138.29	0.025	50.66	0.50	59.09
1600	0.24	-63.52	11.77	122.96	0.026	40.26	0.50	43.40
1800	0.25	-71.32	10.95	110.41	0.027	35.05	0.49	28.03
2000	0.24	-76.46	10.33	98.67	0.029	35.60	0.50	14.54
2200	0.24	-80.73	9.69	88.18	0.029	29.61	0.50	1.12
2400	0.23	-85.23	8.81	77.72	0.028	27.96	0.50	-11.30
2600	0.24	-87.56	7.98	70.34	0.029	22.55	0.49	-22.57
2800	0.24	-92.60	7.49	63.96	0.030	24.65	0.51	-29.18
3000	0.24	-96.30	7.06	58.41	0.031	23.03	0.54	-39.12
3200	0.24	-100.78	6.78	50.86	0.032	21.35	0.55	-48.95
3400	0.25	-103.61	6.55	44.42	0.032	17.00	0.58	-57.57
3600	0.25	-105.48	6.23	37.65	0.032	13.75	0.60	-65.81
3800	0.27	-108.04	5.99	31.44	0.034	13.23	0.63	-73.33
4000	0.28	-108.31	5.81	25.18	0.033	6.89	0.65	-80.04

(Vd=3.0V, Id = 34mA, T = 25 °C, calibrated to device leads)

Freq [MHz]	S11 Mag	S11 Ang	S21 Mag	S21 Ang	S12 Mag	S12 Ang	S22 Mag	S22 Ang
1400	0.27	-54.12	11.68	138.84	0.027	48.70	0.49	56.43
1600	0.29	-69.63	10.95	123.29	0.028	42.06	0.48	40.52
1800	0.29	-78.87	10.14	110.55	0.027	42.89	0.47	24.77
2000	0.28	-85.20	9.60	98.75	0.030	38.74	0.47	11.24
2200	0.28	-89.50	9.01	88.19	0.032	31.08	0.49	-1.69
2400	0.27	-93.83	8.17	77.62	0.031	30.36	0.49	-14.12
2600	0.27	-97.66	7.41	69.90	0.032	26.40	0.48	-25.52
2800	0.27	-102.26	6.97	63.63	0.032	24.81	0.50	-32.82
3000	0.26	-106.54	6.59	57.74	0.033	22.43	0.52	-42.44
3200	0.26	-111.13	6.32	49.91	0.035	17.74	0.54	-52.02
3400	0.27	-114.33	6.09	43.48	0.036	17.81	0.57	-60.85
3600	0.27	-116.53	5.78	36.40	0.036	13.11	0.59	-68.74
3800	0.28	-118.25	5.59	30.09	0.037	13.41	0.62	-76.76
4000	0.29	-119.02	5.41	23.70	0.040	8.86	0.65	-82.83

# 1500 – 4000 MHz High Linearity LNA

## Typical Performance (Vd=5.0V, Id=57mA, T=25°C)

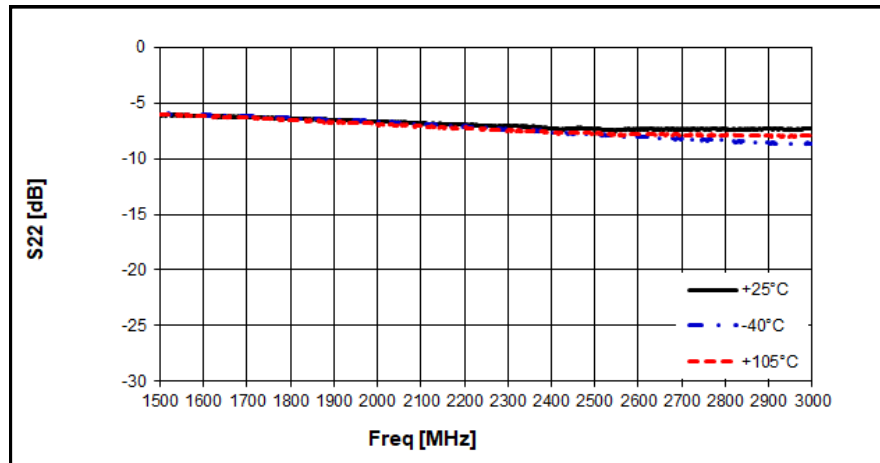
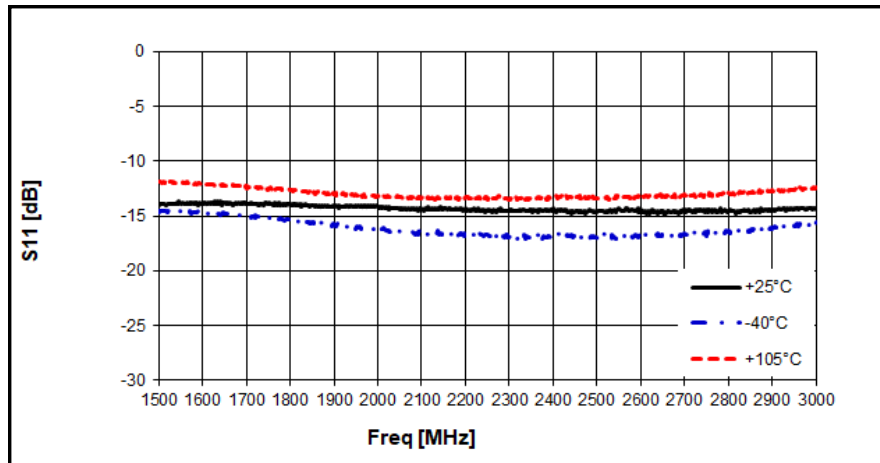
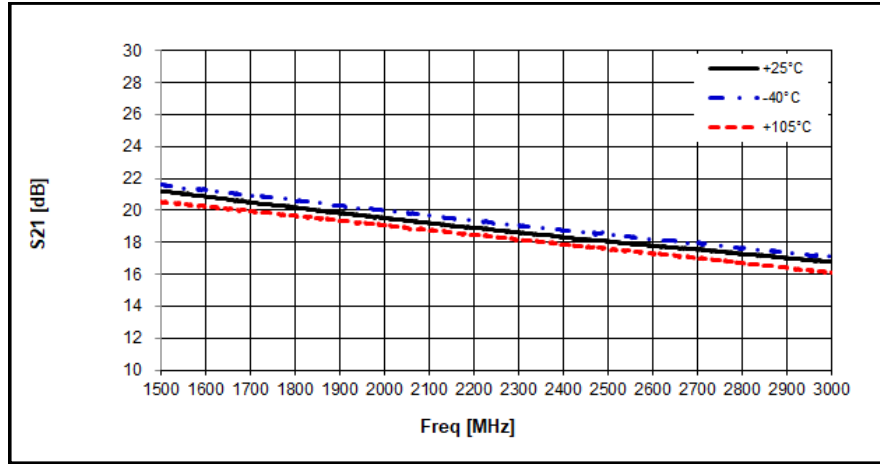

# 1500 – 4000 MHz High Linearity LNA

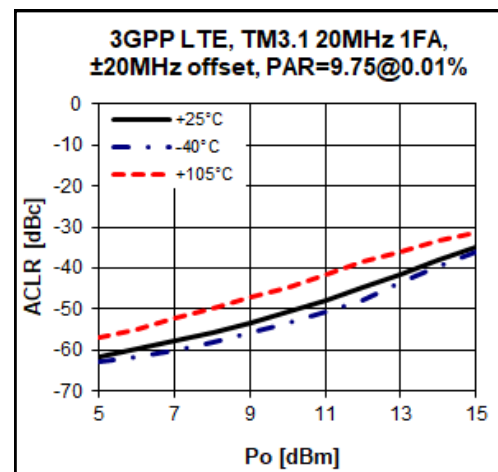
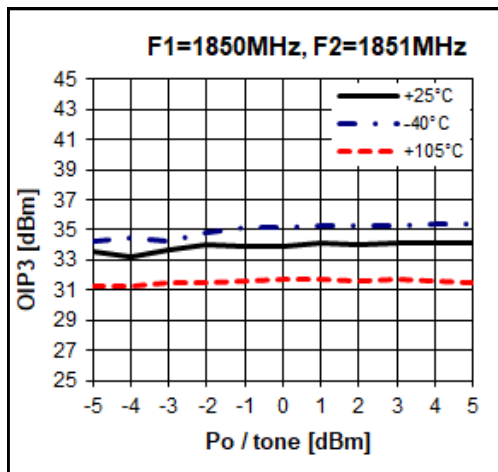
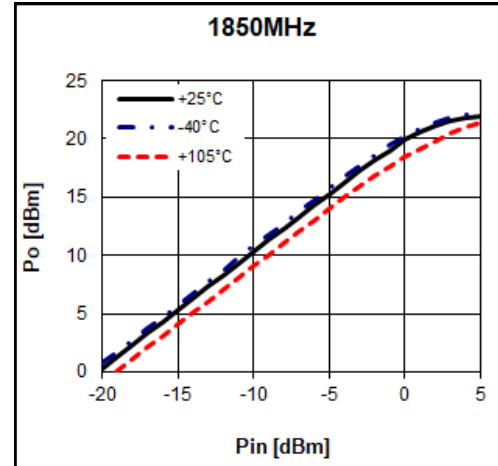
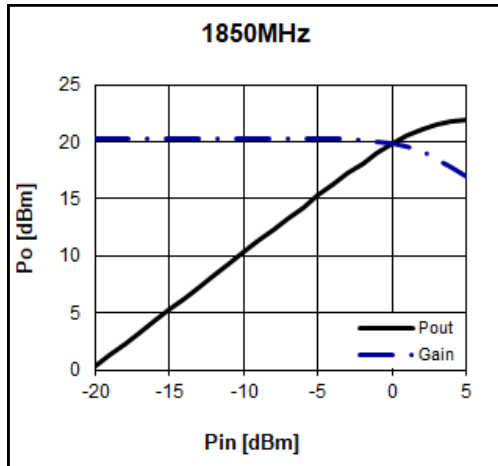

## Noise Figure Temperature Performance

(Vd=5.0V, Id=57mA)

Freq	MHz	1850	2140	2650	3500
Temp [°C]	-40	0.34	0.35	0.41	0.54
	+25	0.32	0.36	0.45	0.83
	+105	0.47	0.51	0.63	1.25

\* Noise Figure data has input trace loss de-embedded.

# 1500 – 4000 MHz High Linearity LNA

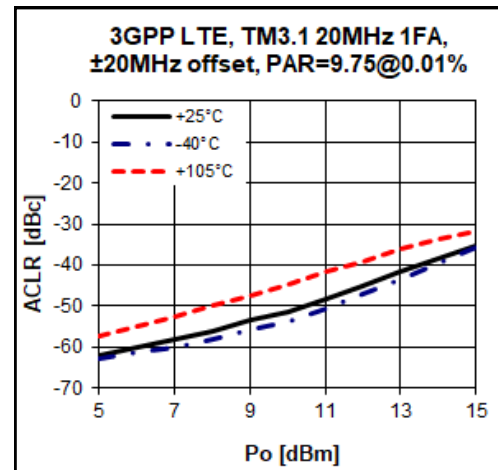
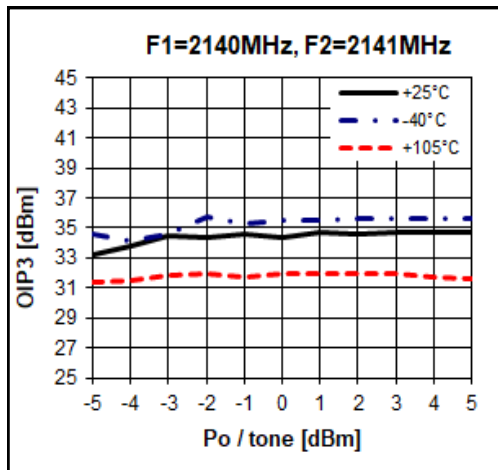
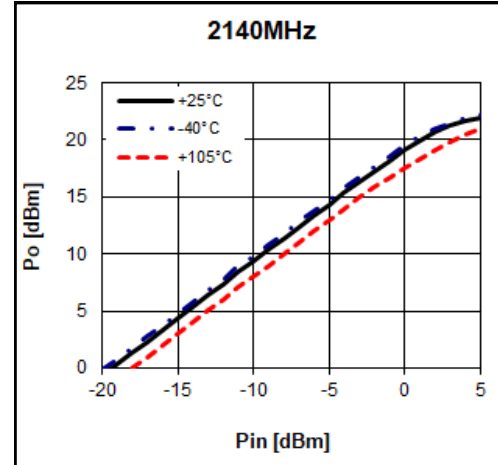
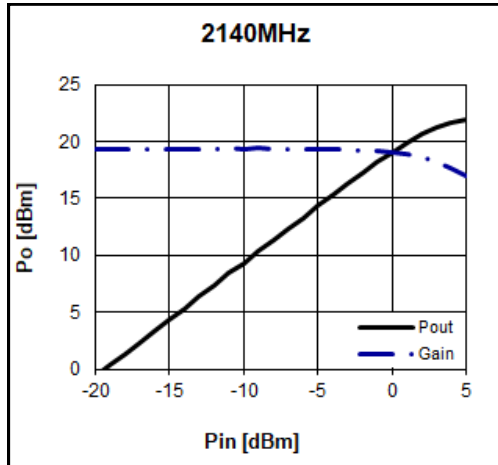

## Noise Figure Temperature Performance

(Vd=5.0V, Id=57mA)

Freq	MHz	1850	2140	2650	3500
Temp [°C]	-40	0.34	0.35	0.41	0.54
	+25	0.32	0.36	0.45	0.83
	+105	0.47	0.51	0.63	1.25

\* Noise Figure data has input trace loss de-embedded.



# 1500 – 4000 MHz High Linearity LNA

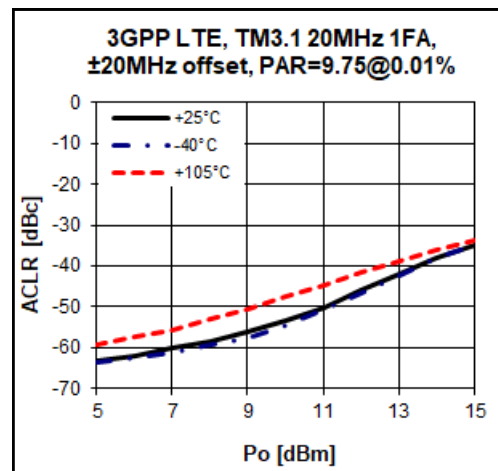
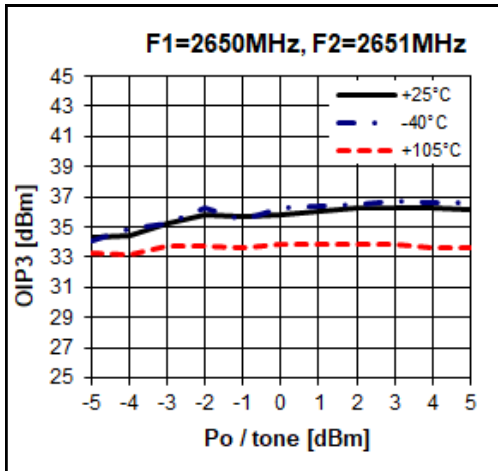
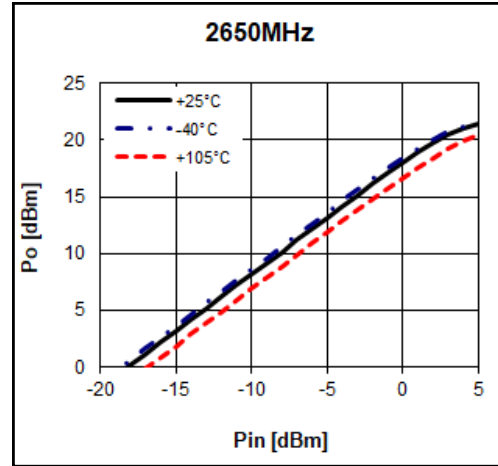
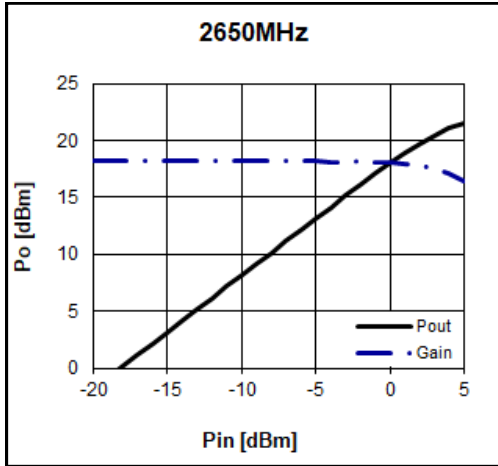

## Noise Figure Temperature Performance

(Vd=5.0V, Id=57mA)

Freq	MHz	1850	2140	2650	3500
Temp [°C]	-40	0.34	0.35	0.41	0.54
	+25	0.32	0.36	0.45	0.83
	+105	0.47	0.51	0.63	1.25

\* Noise Figure data has input trace loss de-embedded.

# 1500 – 4000 MHz High Linearity LNA

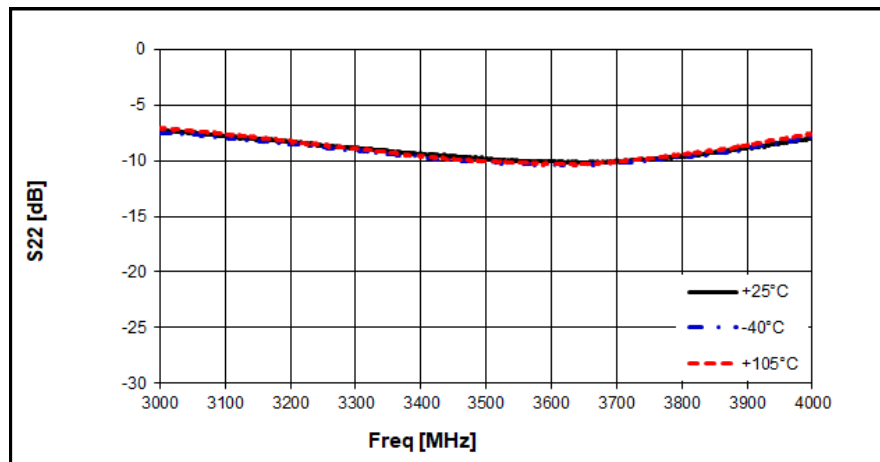
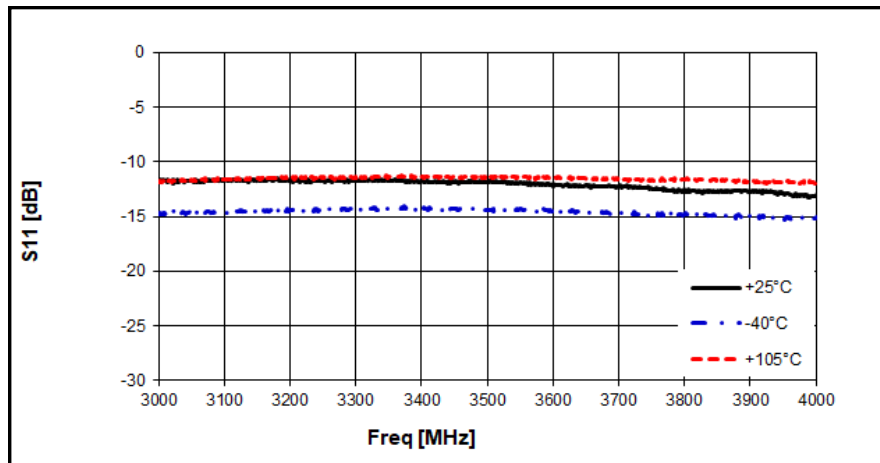
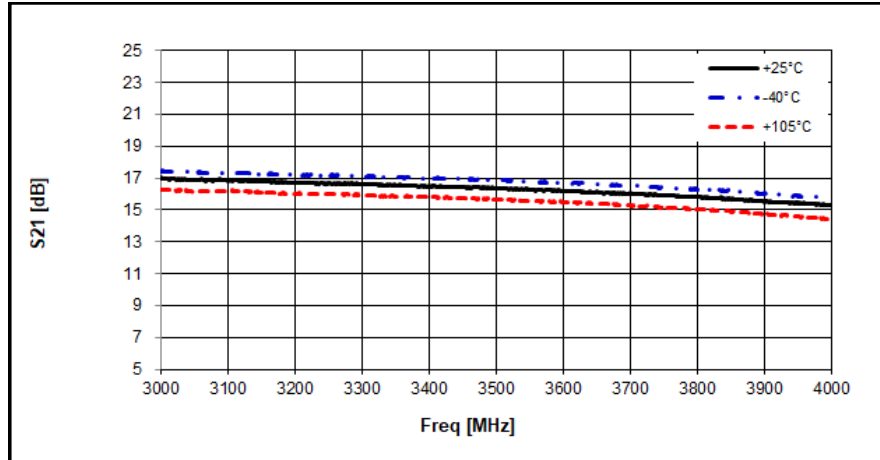

## 1500 – 4000 MHz High Linearity LNA

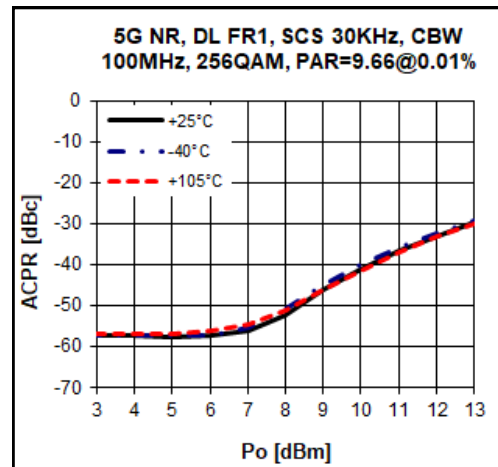
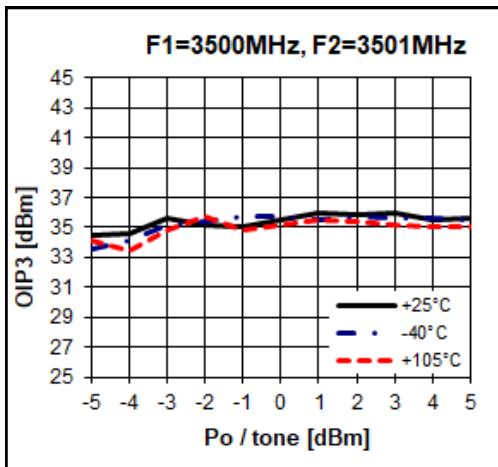
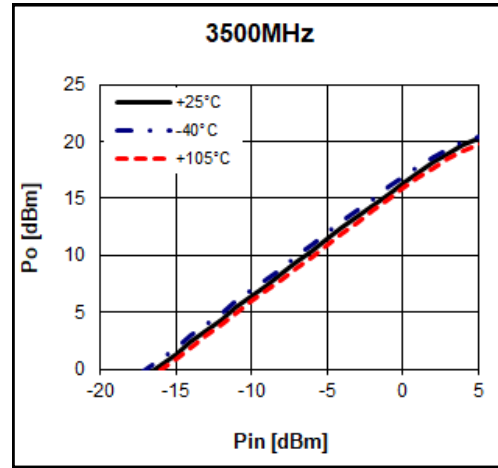
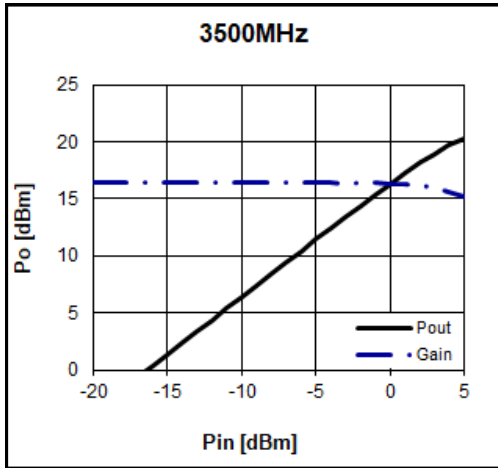

### Noise Figure Temperature Performance

(Vd=5.0V, Id=57mA)

Freq	MHz	1850	2140	2650	3500
Temp [°C]	-40	0.34	0.35	0.41	0.54
	+25	0.32	0.36	0.45	0.83
	+105	0.47	0.51	0.63	1.25

\* Noise Figure data has input trace loss de-embedded.

# 1500 – 4000 MHz High Linearity LNA

## Typical Performance

Vd=3.0V, Id=34mA, T=25°C

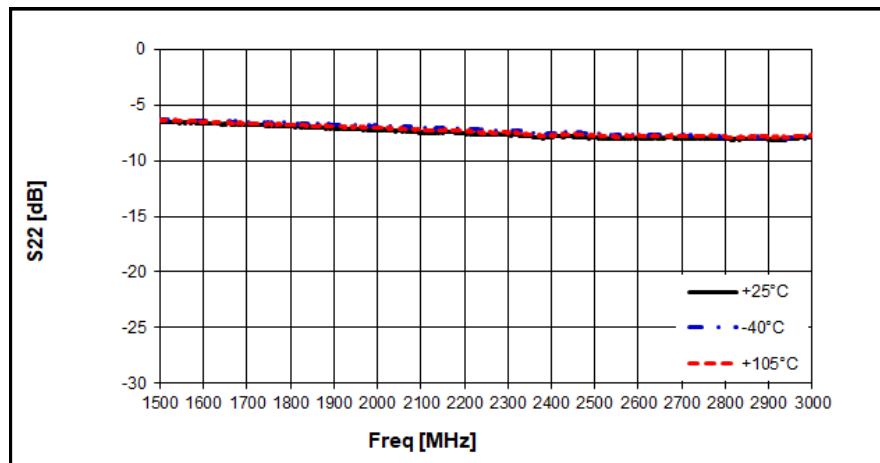
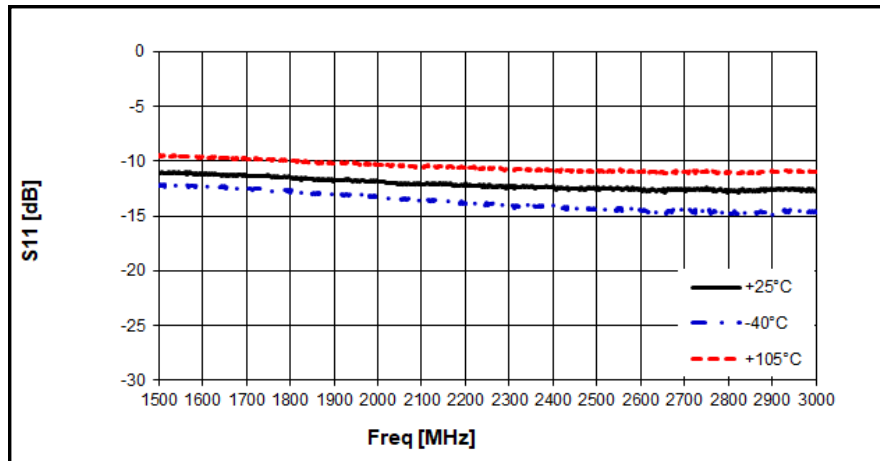
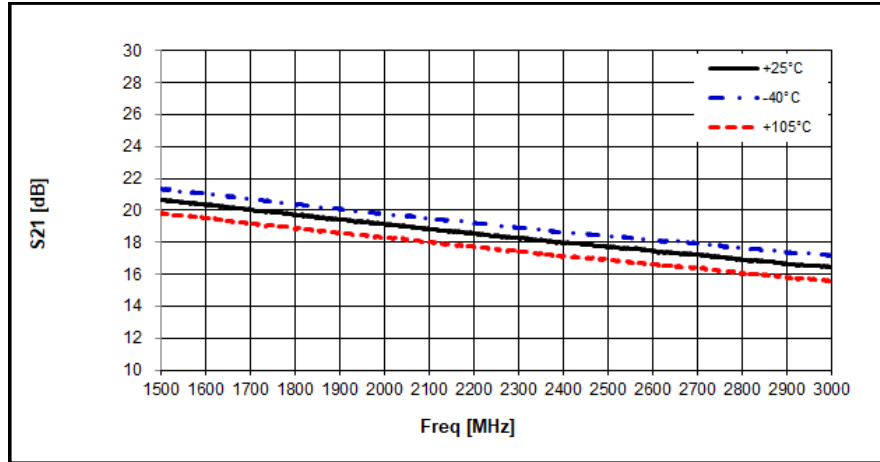

# 1500 – 4000 MHz High Linearity LNA

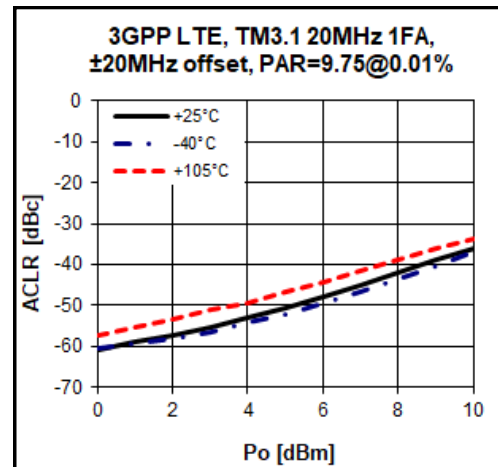
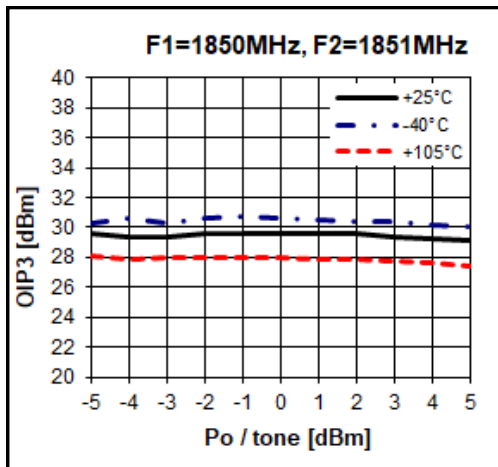
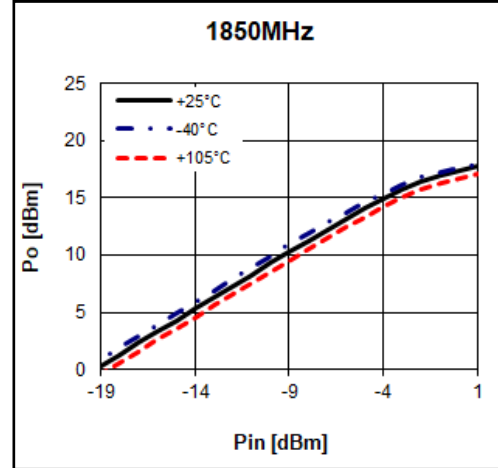
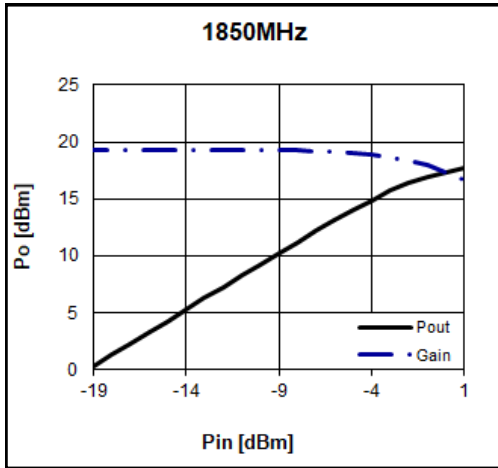

## Noise Figure Temperature Performance

(Vd=3.0V, Id=34mA)

Freq	MHz	1850	2140	2650	3500
Temp [°C]	-40	0.28	0.32	0.40	0.53
	+25	0.31	0.38	0.48	0.82
	+105	0.44	0.50	0.64	1.25

\* Noise Figure data has input trace loss de-embedded.

# 1500 – 4000 MHz High Linearity LNA

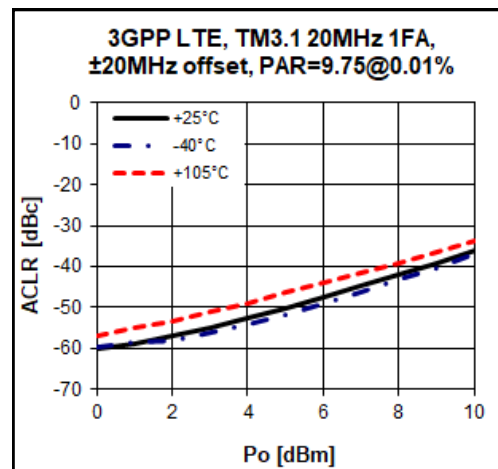
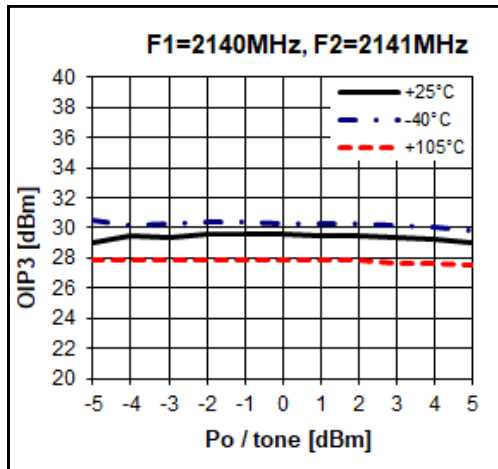
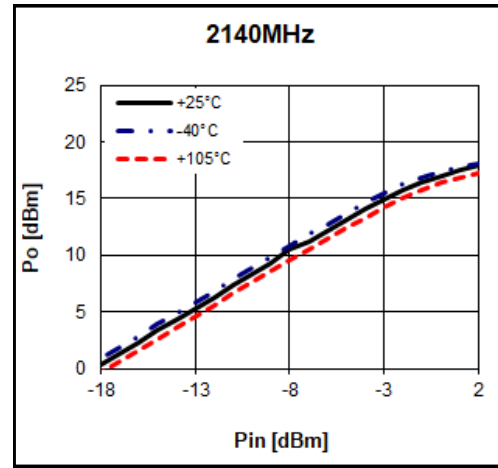
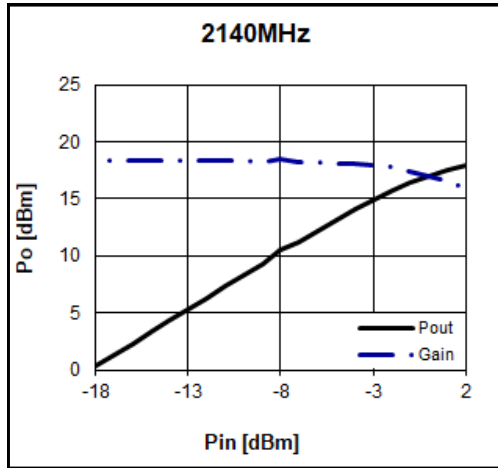

## Noise Figure Temperature Performance

(Vd=3.0V, Id=34mA)

Freq	MHz	1850	2140	2650	3500
Temp [°C]	-40	0.28	0.32	0.40	0.53
	+25	0.31	0.38	0.48	0.82
	+105	0.44	0.50	0.64	1.25

\* Noise Figure data has input trace loss de-embedded.

# 1500 – 4000 MHz High Linearity LNA

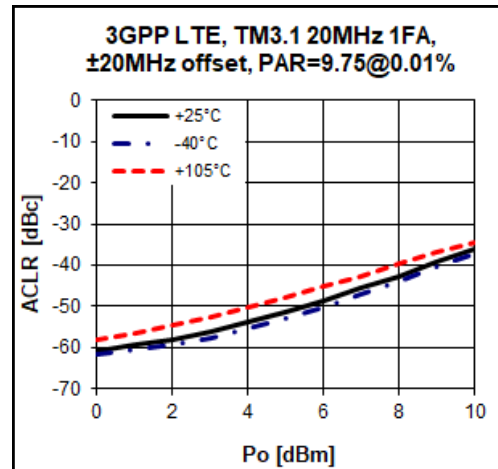
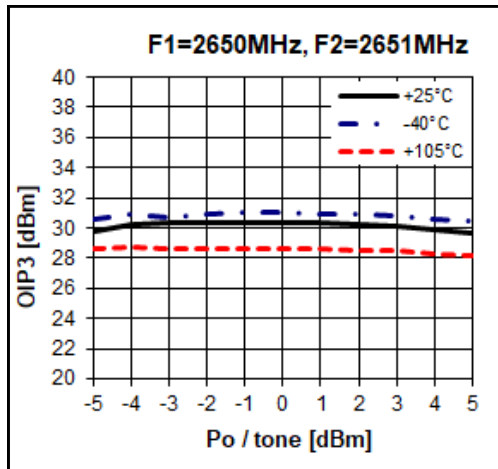
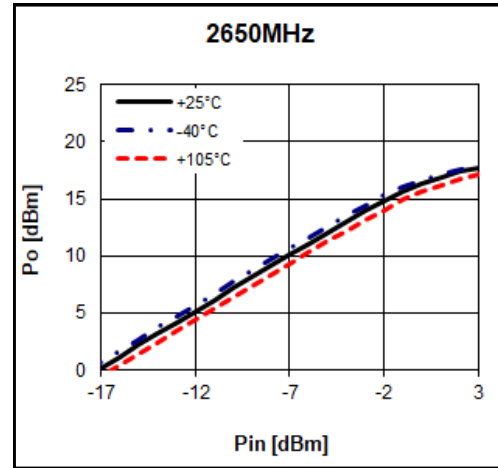
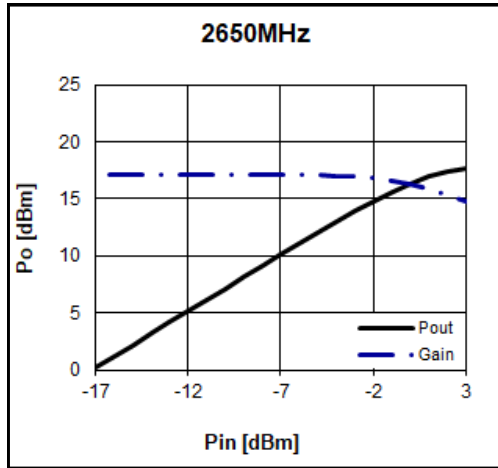

## Noise Figure Temperature Performance

(Vd=3.0V, Id=34mA)

Freq	MHz	1850	2140	2650	3500
Temp [°C]	-40	0.28	0.32	0.40	0.53
	+25	0.31	0.38	0.48	0.82
	+105	0.44	0.50	0.64	1.25

\* Noise Figure data has input trace loss de-embedded.

# 1500 – 4000 MHz High Linearity LNA

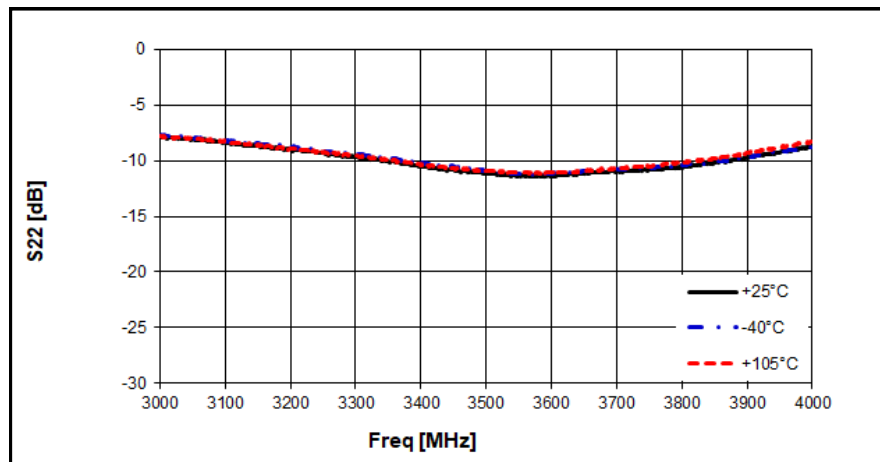
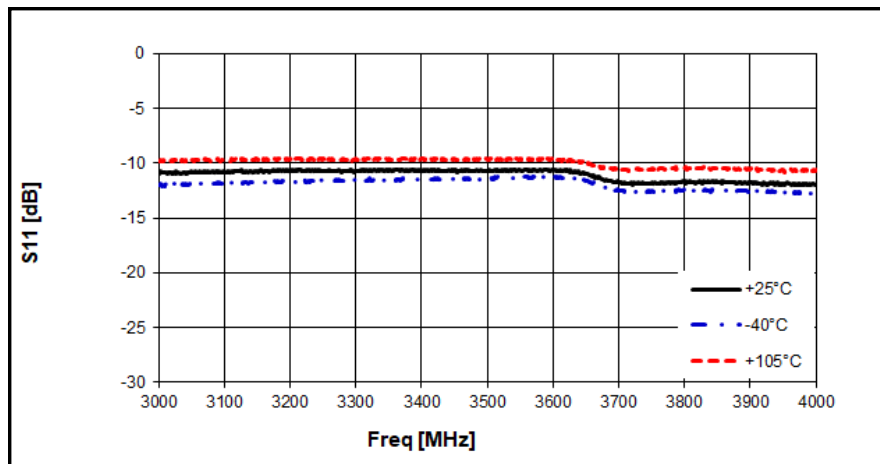
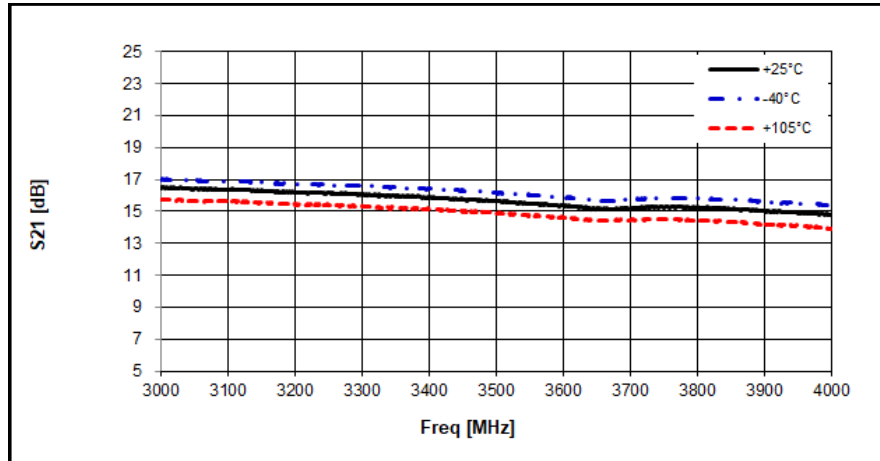



# 1500 – 4000 MHz High Linearity LNA

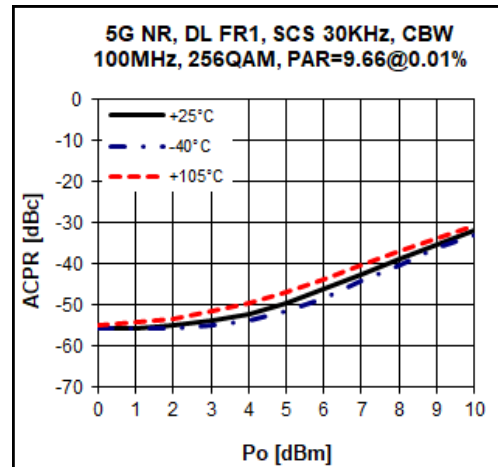
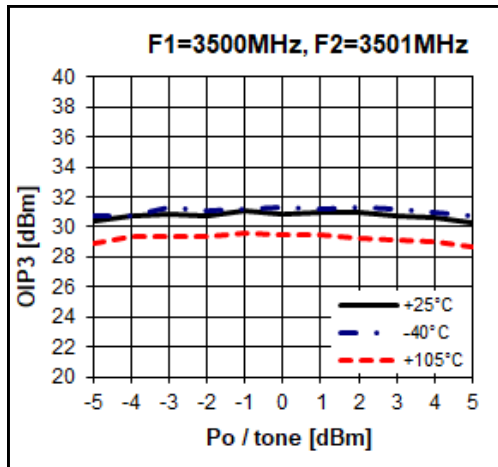
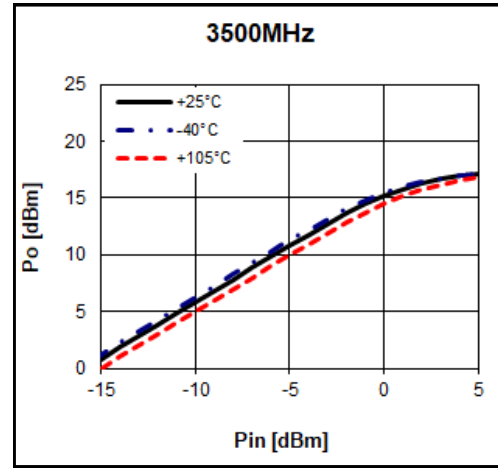
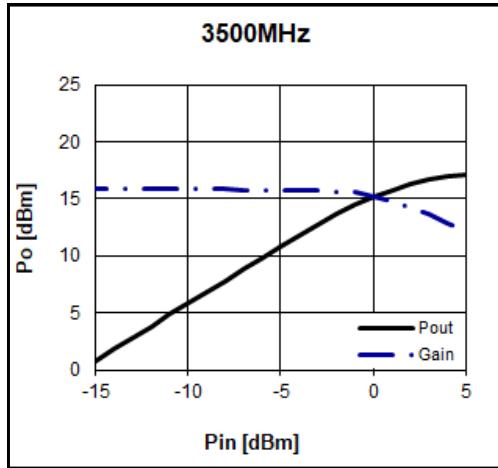

### Noise Figure Temperature Performance

(Vd = 3.0V, Idq = 34mA)

Freq	MHz	1850	2140	2650	3500
Temp [°C]	-40	0.28	0.32	0.40	0.53
	+25	0.31	0.38	0.48	0.82
	+105	0.44	0.50	0.64	1.25

\* Noise Figure data has input trace loss de-embedded.

## 1500 – 4000 MHz High Linearity LNA

### Package Outline Dimension

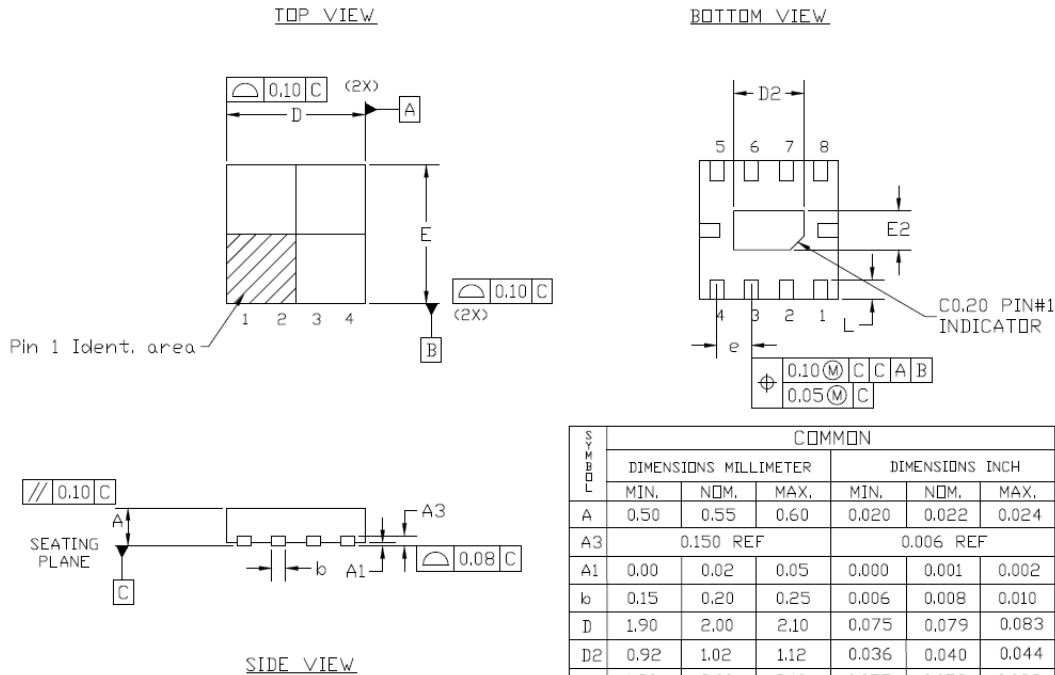

**NOTES :**

1. DIMENSION AND TOLERANCING CONFORM TO ASME Y14.5M-1994.
2. CONTROLLING DIMENSIONS : MILLIMETER, CONVERTED INCH DIMENSION ARE NOT NECESSARILY EXACT.

### Suggested PCB Land Pattern and PAD Layout

#### PCB Land Pattern

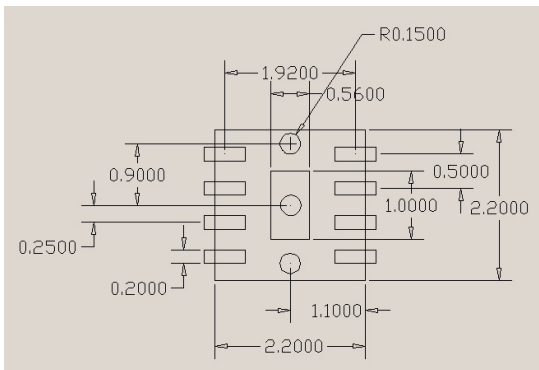

Note : All dimension \_ millimeters

PCB lay out \_ on BeRex website

#### PCB Mounting

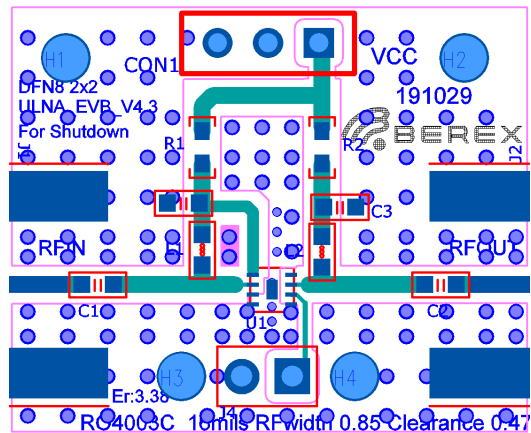

## 1500 – 4000 MHz High Linearity LNA

### Package Marking

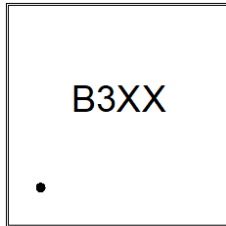

Pin 1

XX = Wafer No.

### Tape & Reel

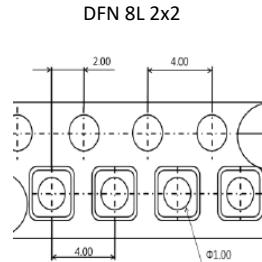

DFN 8L 2x2  
Packaging information:

Tape Width (mm): 8

Reel Size (inches): 7

Device Cavity Pitch (mm): 4

Devices Per Reel: 3000

### Lead plating finish

100% Tin Matte finish

(All BeRex products undergoes a 1 hour, 150 degree C, Anneal bake to eliminate thin whisker growth concerns.)

### MSL / ESD Rating

<b>ESD Rating:</b>	Class 1C
<b>Value:</b>	Passes < 2000 V
<b>Test:</b>	Human Body Model (HBM)
<b>Standard:</b>	JEDEC Standard JS-001-2014

<b>MSL Rating:</b>	<b>Level 1 at +260°C convection reflow</b>
<b>Standard:</b>	JEDEC Standard J-STD-020



Proper ESD procedures should be followed when handling this device.

## 1500 – 4000 MHz High Linearity LNA

---

### RoHS Compliance

This part is compliant with Restrictions on the Use of Certain Hazardous Substances in Electrical and Electronic Equipment (RoHS) Directive 2011/65/EU as amended by Directive 2015/863/EU.

This product also is compliant with a concentration of the Substances of Very High Concern (SVHC) candidate list which are contained in a quantity of less than 0.1%(w/w) in each components of a product and/or its packaging placed on the European Community market by the BeRex and Suppliers.

### NATO CAGE code:

2	N	9	6	F
---	---	---	---	---