

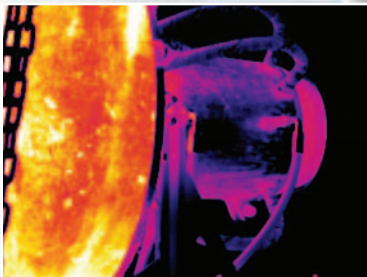

# TiX560/520/500 Inspection Guidebook

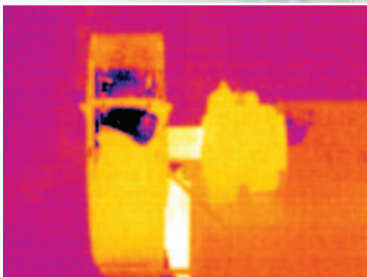

# INFRARED INSPECTION APPLICATIONS

To keep industrial plants running at optimum levels, plant managers need to maintain and troubleshoot dozens of electromechanical systems. However, these days they have fewer staff to accomplish that. One trend that helps to counter that shortage of trained maintenance staff is the evolution of infrared imaging technology to provide clearer images and, increased thermal sensitivity at a more affordable price in more portable and easier to use tools.

Many problems in electromechanical systems show up at an early stage as excess heat. The new Fluke TiX560, TiX520 and TiX500 Expert Series Thermal Imagers were developed to be used for daily troubleshooting and maintenance tasks to help technicians identify problems early. These imagers' high resolution and thermal sensitivity help detect all types of electrical and mechanical problems—from overheated conductors and faulty bearings, to hot spots on motor casings and printed circuit boards. And their new ergonomic features such as the 180° articulating lens, 5.7 inch touchscreen LCD and shoulder strap, make it easier to work for extended periods of time.

The following application notes provide real world examples of how you can put these imagers to daily use in manufacturing and processing operations.

## **Expedite electrical troubleshooting**

See how easy it is to put the innovative new features in Fluke TiX5XX imagers to work for inspecting a wide range of electrical components.

## **Find hot bearings fast**

Discover why the high resolution and ergonomic design makes the Fluke TiX5XX thermal imagers ideal for measuring the temperature of running bearings from a safe distance.

## **Extend motor service life**

Learn how Fluke TiX5XX imagers can help you troubleshoot problems in a running motor.

## **Find pipe blockages**

Find out how Fluke TiX5XX imagers can expedite pipe inspections and provide the thermal detail to detect small temperature changes.

## **Identify circuit board hot spots**

Learn how Fluke TiX5XX thermal imagers can detect subtle temperature differences without touching the target board.





**Find hot bearings fast with a high resolution thermal imager with articulating lens**

Overheated bearings can cause machinery to fail resulting in a sudden interruption of the production line. Replacing those bearings can be costly both in terms of materials and downtime. To extend bearing life, they should be regularly inspected for wear and overall health. But before you shut down the production line or motor to perform that maintenance, you can quickly scan bearings with a thermal imager to prioritize those that need service first.

Because bearings have to be inspected while in use, a thermal imager is an ideal non-contact inspection tool. It enables you to detect the running temperature of bearings quickly, from a safe distance. That way you can find overheated bearings before they cause failures, or excess strain on motors.

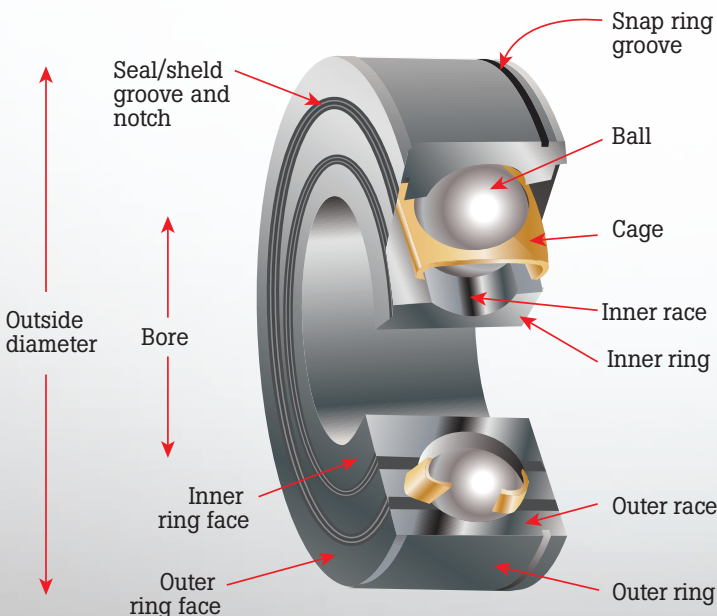
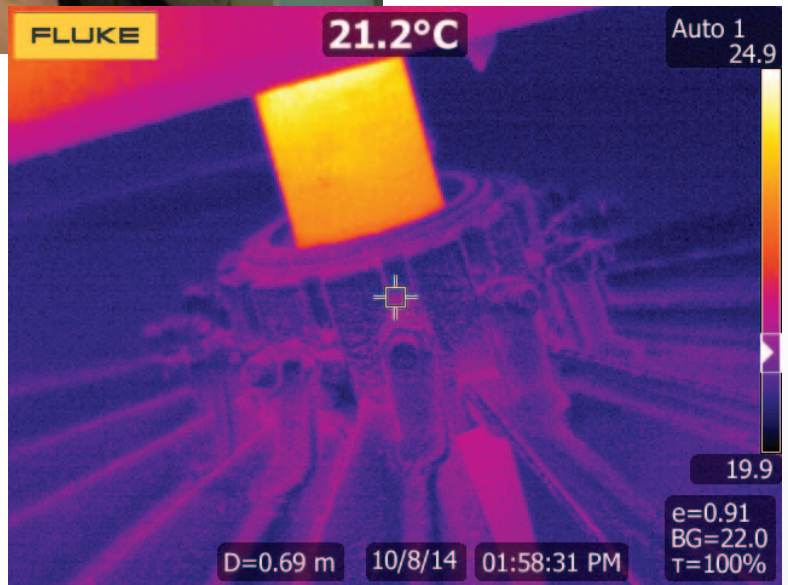

**Top 4** Bearing inspection applications

- 1 General preventive maintenance
- 2 Troubleshooting
- 3 Working in tight spaces
- 4 Reducing motor strain

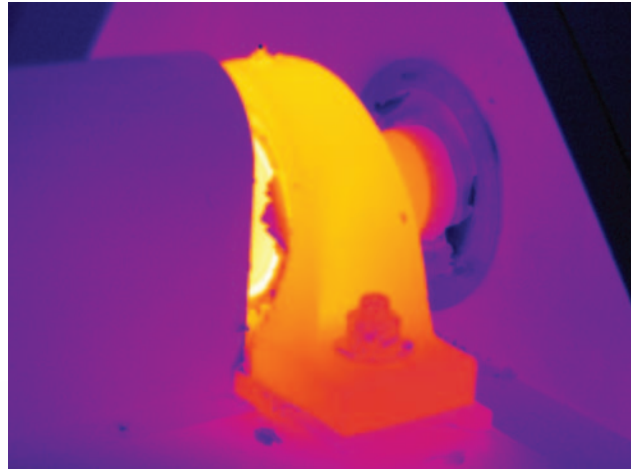
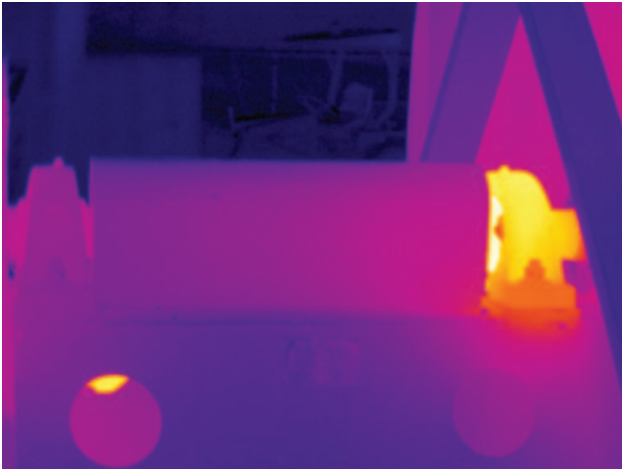

With the TiX560 you can clearly see that the right side of the bearing has an issue.

### Expediting bearing inspections from every angle

High resolution, thermal sensitivity, and an ergonomic articulating lens make the Fluke TiX5XX imagers a great choice for bearing inspection applications, including:

#### General preventive maintenance

The high resolution and thermal sensitivity of the TiX5XX imagers make it possible to scan bearings from a safe distance, making it practical to scan all of your equipment to establish a baseline that you can compare to future scans. Large on-camera memory stores thousands of thermal images and hours of radiometric video so you can compare new images to baseline images right on the camera. Or access stored images from your central database, through Fluke Connect™. This helps technicians identify issues in the field and expedite maintenance.

#### Troubleshooting

Overheated bearings are typically found by comparing the surface temperature of a suspect bearing to an adjacent bearing of the same type under the same load. Overheating can be caused by too much or too little lubricant, incorrect mounting or incorrect replacement bearings. Using a TiX5XX imager you can stand at a safe distance from the target

and get a high resolution thermal image of the device as it runs.

The articulating lens adjusts up to 180° to provide a good view of the target, from above, below, or around other objects, while you view the results on the large 5.7 inch touchscreen. As you store the images and video you can note anomalies or points of concern in voice and/or text annotations. And you can analyze the images right there on the imager to potentially resolve the problem while on site.

#### Working in tight spaces

A lot of bearings are located in hard to reach locations underneath conveyors and obstructed by other equipment. With some thermal imagers you would have to shoot blind, aiming the imager at a target that you can't see and hope it is in focus. With a TiX560, TiX520 or TiX500 imager, you can turn the articulating lens 180° to a position where it gets the clearest shot of the bearings, and then view the image on the touchscreen before you save it. This helps ensure that you get good images so you can find problem bearings more easily.

#### Reducing motor strain

The average production line can have conveyors with thousands of bearings. If there's a problem, the sooner you can find it, the less strain it will put on the conveyor motor. The TiX560, TiX520 and TiX500 have LaserSharp® Auto Focus that uses a built in laser distance meter to calculate the distance to the target and then precisely focuses on that target. For longer distances you can add a telephoto lens or use the zoom feature. For more context, combine the infrared image with a visible light image in AutoBlend™ on the imager to quickly identify where the overheated bearing is located on the conveyor. By pinpointing a problem bearing quickly, you can avoid having to replace the motor or gear box, not to mention potential downtime costs.

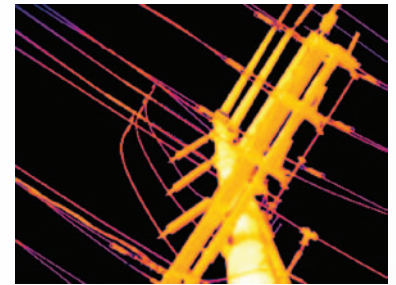
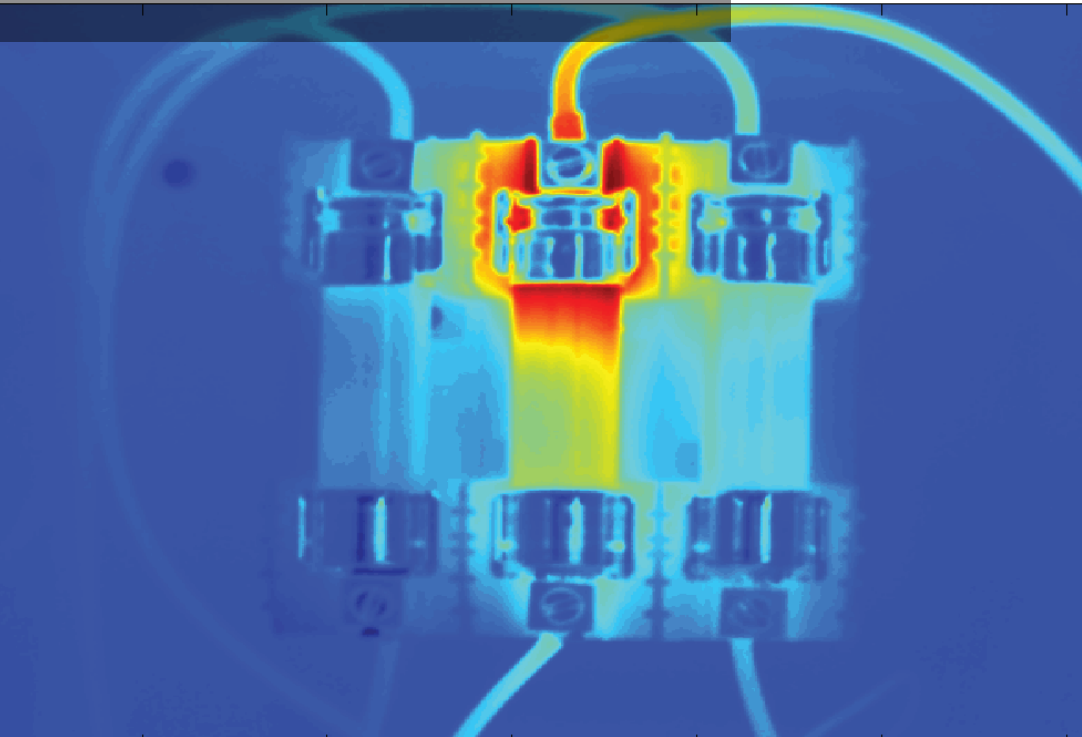

### Expedite electrical troubleshooting with 180° of high resolution infrared flexibility

A typical industrial plant has thousands of electrical connections and components that need to be inspected. Those include contactors, switches, circuit breakers, switchgear, and battery banks, among others. A failure in even the smallest component can cause exponential damage to a company's bottom line. At the same time, the move to leaner maintenance staffing has made performing regular maintenance on all those components nearly impossible. So the challenge now is to find electrical problems at an early stage.

Fortunately, thermal imaging technology has started to level the playing field. With the thermal sensitivity, resolution, ease of use and innovative new features available in the new Fluke TiX5XX Expert Series Thermal Imagers can help you perform maintenance tasks more quickly and easily, helping you get more done in less time.

Most problems in electrical supply or distribution systems show up as excessive heat, which can be caused by:

- Overloaded systems or excessive current
- Loose, tight, dirty or corroded connections
- Component failures
- Wiring mistakes or under-specified components
- Power quality issues like phase unbalance or harmonics

One of the quickest ways to find these problems is to scan the area with a high resolution thermal imager.

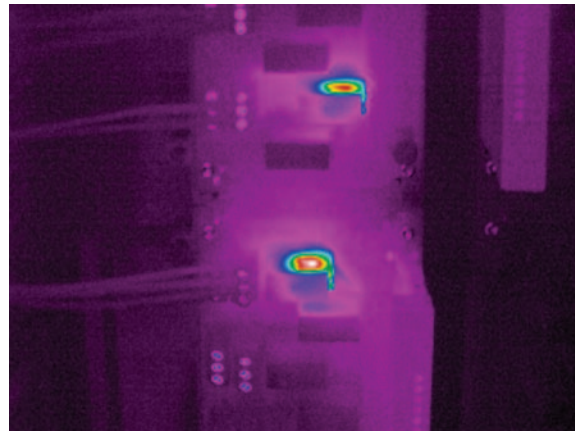

### Top 4 Electrical applications

- 1 Overhead cable trays
- 2 Three-phase conductors
- 3 Switch gear cabinets
- 4 Electrical panels



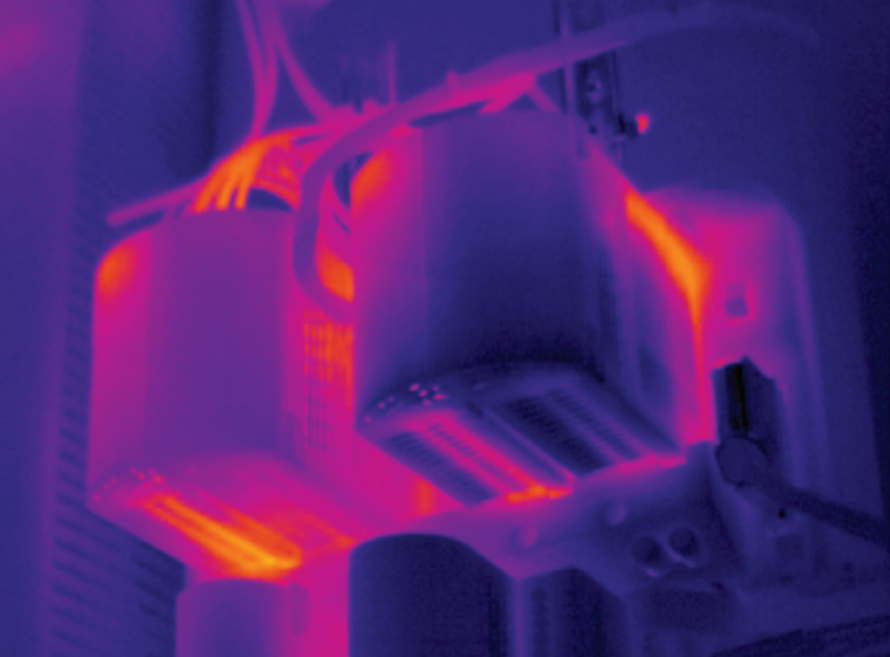

## Finding electrical anomalies with thermal imagers

Understanding your applications and having baseline information will make it easier for you to find possible issues in your facility. Once you have that information, you can put the Fluke TiX560, TiX520 and TiX500 thermal imagers to work inspecting a wide range of electrical components, including:

### Overhead cable trays

Scanning miles of overhead cable in an industrial facility can be a pain in the neck. With the 180° articulating lens in the TiX5XX you can tilt the lens to scan the ceiling while you're looking at the large 5.7 inch LCD touchscreen on the imager from a comfortable angle. As you scan, you can capture images, annotate points of concern with text or voice notes or record radiometric video for further analysis or documentation. Plus you don't have to worry about debris falling on your face.

### Three-phase conductors

You can use spot temperature markers to quickly find hot neutrals or overheated conductors in a three-phase system. Just put a spot temperature marker on each conductor to see all three phase temperatures simultaneously and quickly locate temperature differences.

### Switch gear cabinets

With the TiX5XX you can scan switch gear through an infrared window to find internal faults while the system is running, without having to open electrical panel doors. The high resolution and low NETD help you find very subtle differences in temperature indicating possible internal faults. You can capture IR images and combine them with visible light images in AutoBlend™ on the imager to quickly identify the label of an overheated component in the cabinet. Or record radiometric video to analyze the equipment over time.

### Electrical panel

Using the TiX5XX Expert Series imagers, you can quickly scan a panel. Where you discover higher temperatures, just follow that circuit and examine associated branches and loads from a safe distance. With Continuous AutoBlend™ on the TiX560 you can blend the infrared image with up to 100 % visible light image to clearly read the labels on the circuit breakers or tags on the equipment to easily locate problem points.

## Other electrical connections to be inspected with a thermal imager

- Power inputs and outputs to devices like VFD's, transformers, and power supplies
- Bad contacts on contactors and high-voltage switches
- Power distribution, circuit breakers and fuses
- Junction boxes and terminal blocks

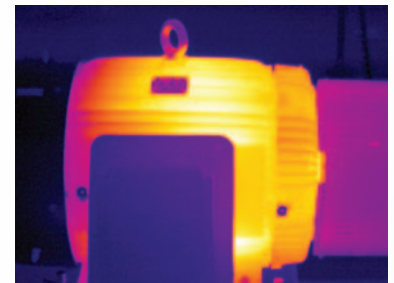
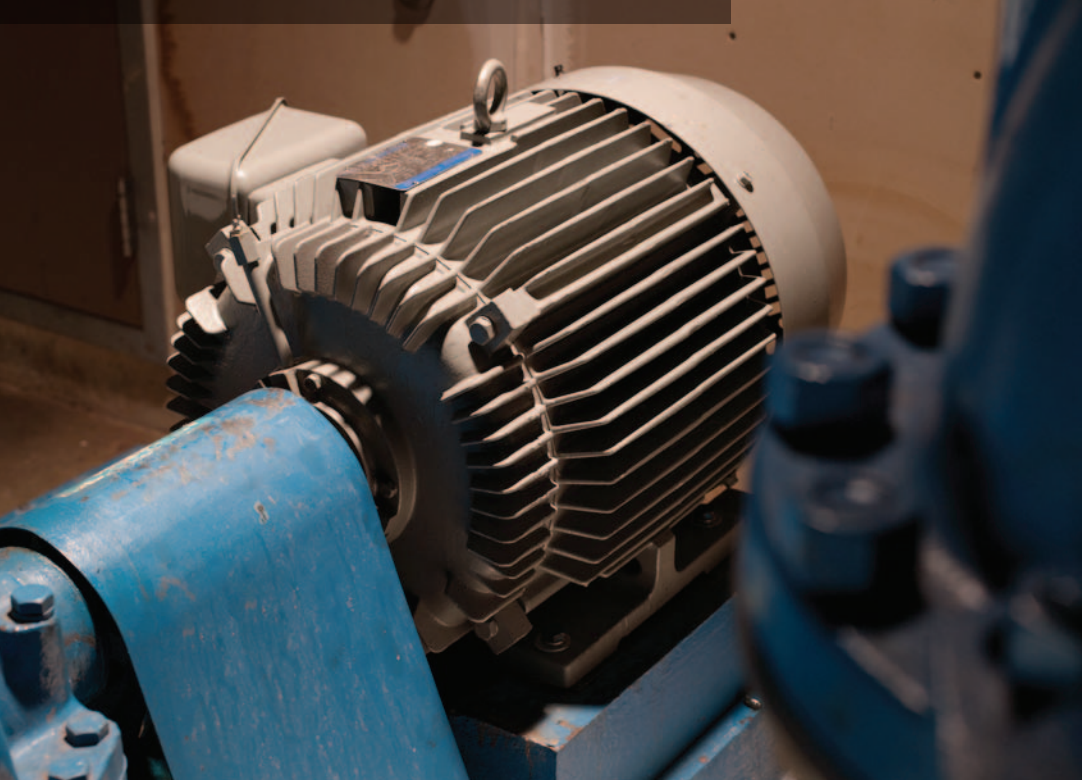

### Extend motor service life with infrared inspection

Motors take a lot of abuse in today's manufacturing and process plants. They are costly to replace, so preventive maintenance is critical to keeping them in top operating condition and extending their service life. Overheating is one of the biggest factors in shortening that life. Operating at a temperature of ~10° over its rated value can cut in half the service life of a motor. Therefore, regularly checking motor operating temperature is crucial to ensuring reliable operation of production systems.

A thermal imager can help you find overheating in a running motor so you can address the problem before the motor is damaged. Fluke TiX5XX Expert Series thermal imagers make it even easier with their 180° articulating lens that you can aim at the motor from above, below, or sideways. With the large 5.7 inch touchscreen you can view your target straight on before capturing the image. The high resolution (up to 640 x 480 on the TiX560), excellent thermal sensitivity, LaserSharp® Auto Focus, and other enhancements included in Fluke TiX5XX thermal imagers help to ensure that you get clear crisp images from a safe distance.

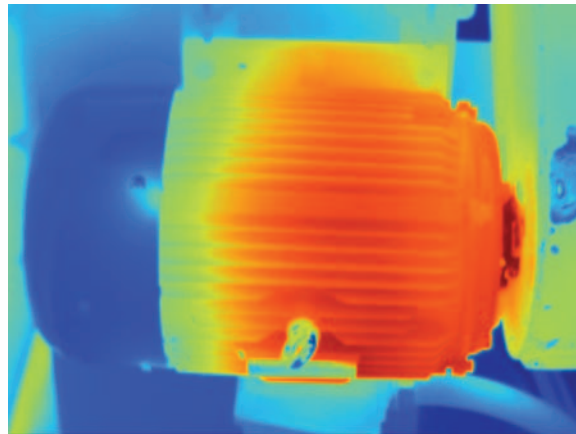

### Top 4 Motor inspection applications

- 1 Overheated bearings and couplings
- 2 Hot spots in motor casings
- 3 Overheated cables and power connections
- 4 Overheated internal wiring

## Finding trouble spots in motors just got easier

Motors come in all sizes, and most facilities have hundreds or even thousands to maintain. The articulating lens, thermal sensitivity, and LaserSharp™ Auto Focus on Fluke TiX5XX thermal imagers make it easier to scan many motors quickly and easily and have high confidence in the quality of images and onboard diagnostic capabilities to find:

### Overheated bearings and couplings

Poor lubrication or misalignment of mechanical components can cause motor bearings and couplings to overheat and vibrate, which can put undue stress on your motor and lead to early failure. With Fluke TiX5XX imagers you can quickly zero in on overheated pillow block bearings, and maintain or replace them before they add stress that can damage the motor and result in much higher repair or replacement costs.

### Hot spots in motor casings

A short-circuit in the internal iron core or winding of the motor due to aging insulation or insufficient ventilation can cause motor casings to overheat. Although you can't see the inside of a motor with a thermal imager you can find an indication of a problem by detecting an above-average surface temperature on the motor.

### Overheated cables and power connections

Unbalanced voltage, overloads, or degraded wires can cause cables to overheat. Once you find hot spots on cables with a TiX5XX camera you can connect from one to five different Fluke Connect™-enabled wireless modules for other measurements and view them at the same time on the same screen as the infrared image. You can share the measurements live with other team members, who have the Fluke Connect™ mobile app on their smart phones, and save them to a central database for future reference or further evaluation and reporting.

### Overheated internal wiring

Typically, wire connections don't generate enough heat to create a temperature difference on junction box casings. However, a faulty wire connection due to a loose, oxidized, corroded, or overtightened connection can raise the temperature of that junction box casing higher than normal. You can quickly navigate around other equipment using the articulating lens on the Fluke TiX5XX imagers to compare the temperatures of junction box casings of similar applications. If any show up hotter than the others, you can mark them for further examination.

## Some additional helpful tips

It is a good practice to schedule a regular infrared inspection of all critical motors. You can upload those images to a central database or to your computer and compare subsequent images to the baseline to more easily determine whether a hot spot is normal. You can also scan motors after a repair to confirm that the repair worked.

When inspecting motors with a Fluke TiX5XX thermal imager, remember to note the load and ambient temperature of the motors that you are scanning. You can save those notes in camera memory as text and voice annotations. The large on-camera data storage capacity on the TiX5XX imagers allows you to create a comprehensive file for each asset to include additional visible light images of the motor, motor name plate, VFD or power source, and text and audio notes about the issues related to that asset.

You can also edit images on the TiX5XX thermal imagers or in the software changing the color palette, blending the IR and visible light level, view in picture-in picture mode and adjust the level and span to help identify more details. You can set alarms for high or low temperatures in infrared or set up the imager to take images at certain time intervals for trending.

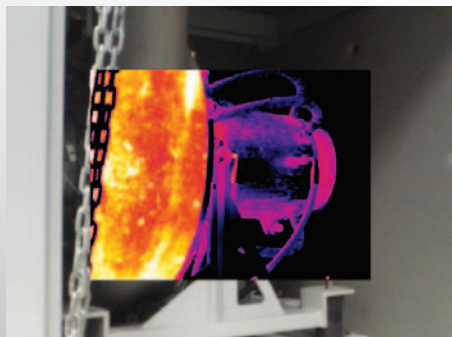

Identify the extent of the problem and exact location with AutoBlend™ and picture-in-picture.



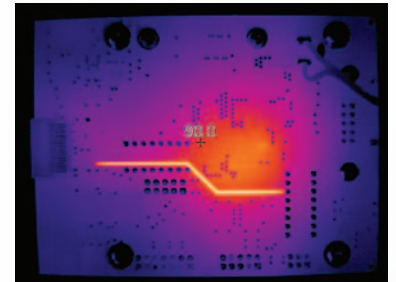
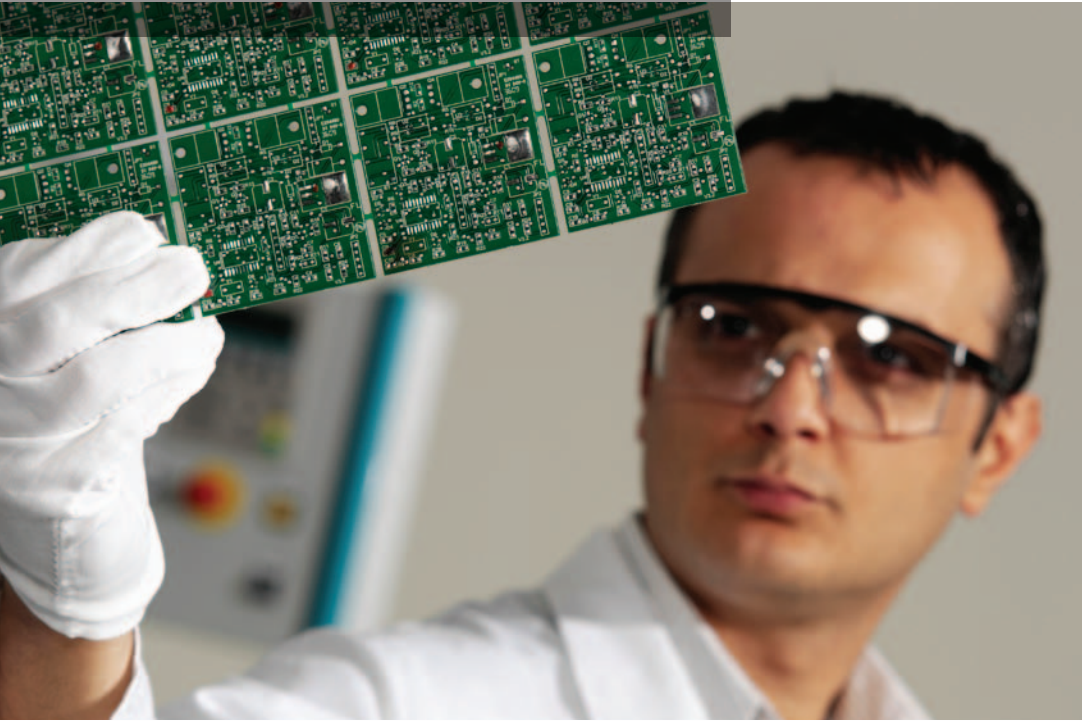

## Find circuit board hot spots at the design stage with a high resolution thermal imager

Printed circuit boards (PCBs) are an integral part of a growing number of products. As electronic devices get smaller and thinner, so do the circuit boards that power them. At the same time those circuit boards need to be rugged and reliable, to mechanically support electronic components and connect those components via conductive pathways, called traces. Design engineers need to ensure that their designs will work in real life situations so stringent prototype testing is crucial.

Thermal imagers can be very effective for testing prototype PCBs because they can detect subtle temperature differences between very small components and current traces without touching the target board in most applications. These temperature differences can indicate a weakness or potential fault in the design. Using a non-contact thermal imager to measure performance or changes in thermodynamic properties of board components can help eliminate variations that might be introduced by a contact temperature device such as an RTD or thermocouple. As a result, inspecting PCBs with a thermal imager can help improve quality and expedite design and production.

However, not all thermal imagers are the same. Make sure you use an imager that has the capabilities required for this application. Better spatial resolution and thermal sensitivity will help ensure more accurate measurements.

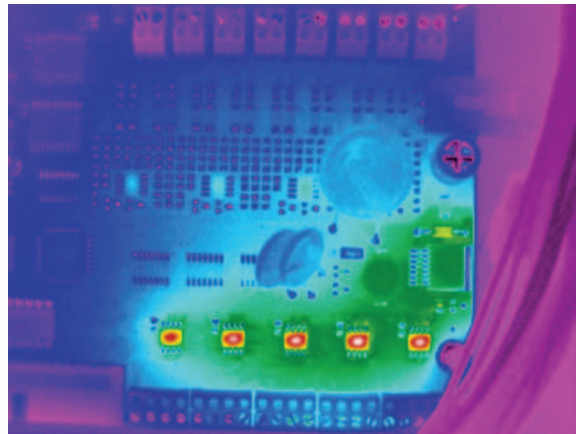

### Top 3 Circuit board applications

- 1 Comparing component temperature
- 2 Analyzing component load
- 3 Establishing production processes

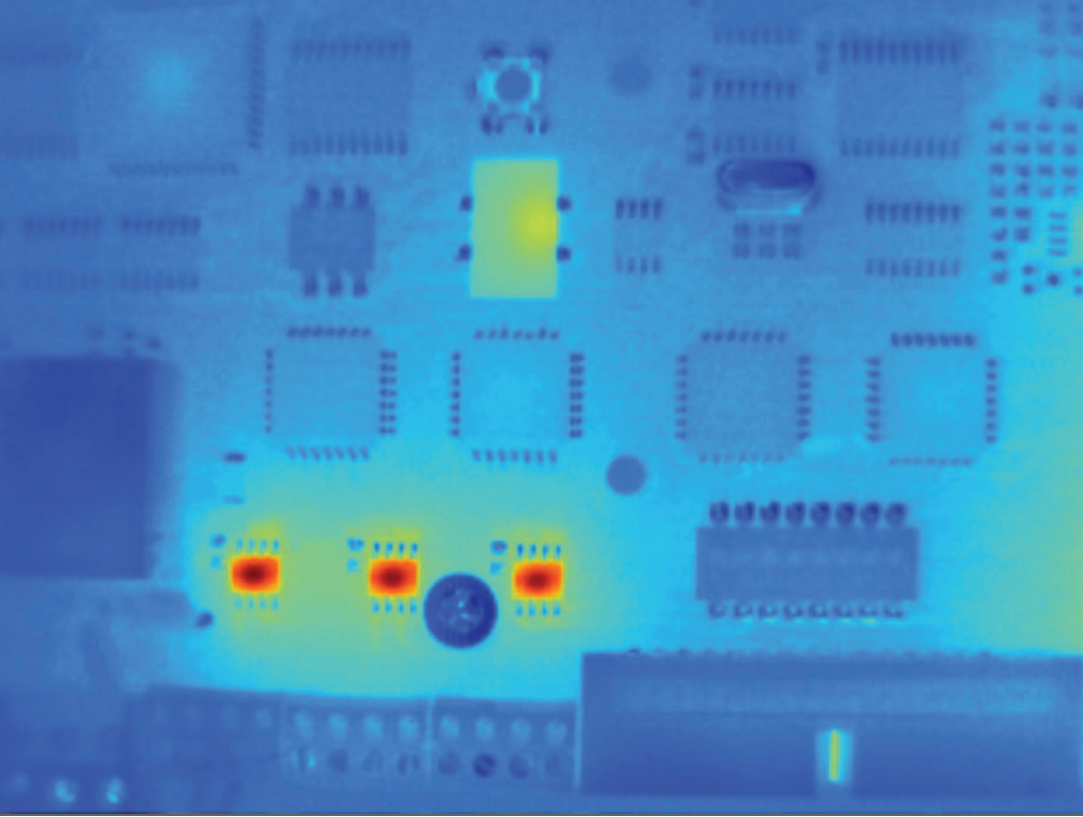

## Reviewing PCB heat patterns to improve your design

Fluke TiX5XX thermal imagers can be used to test circuit boards at every stage of development, as well as in production. By detecting temperature differences between components, these thermal imagers can analyze circuit performance and help detect potential faults in the design stage. For example:

### Comparing component temperature

Thermal issues are a major cause of circuit board failure. After populating a prototype board, you can power up a board to the specified level at which it is expected to run in the finished product and monitor the results using the Fluke TiX5XX series thermal imagers. The 640 x 480 resolution in SuperResolution mode on the TiX560, combined with image sharpening, and low NETD enhances the ability to identify very slight temperature differences between small

components and their connection points. That information can help you determine what modifications are needed for the design. Then you can rescan the modified design to ensure that the problem is resolved.

### Analyzing component loads

If a PCB is to be used in a battery powered portable device it is important to minimize power consumption. Using a TiX5XX you can possibly identify which components are using substantial power to help determine if they are within specifications.

### Establishing production processes

You can use the large storage and radiometric video capabilities on the TiX560 to record thermal images and/or video of various manufacturing processes, such as solder point cooling so that you can set optimum cycle times for automated systems. You can also run quality review scans with the TiX5XX imagers at various stages of the manufacturing process to find issues that might lead to component failure down the road.





## Using thermal imagers to find pipe blockages

Whether they carry liquid product, water, steam, natural gas, or oil, keeping pipes flowing smoothly is critical to safe and efficient manufacturing and processing systems. Blockages, thinning, and corrosion can diminish the efficiency and safety and result in leaks that could cause serious damage to your facility and your people.

The challenge is to find problems such as carbon deposition, thinning, and cracking in hundreds or thousands of feet of pipe, as well as leaks and clogs in heat-exchanger and reactor tubes. A high resolution thermal imager can expedite inspection of this equipment and provide the thermal detail to detect small temperature changes that can aid early detection of potentially big problems.

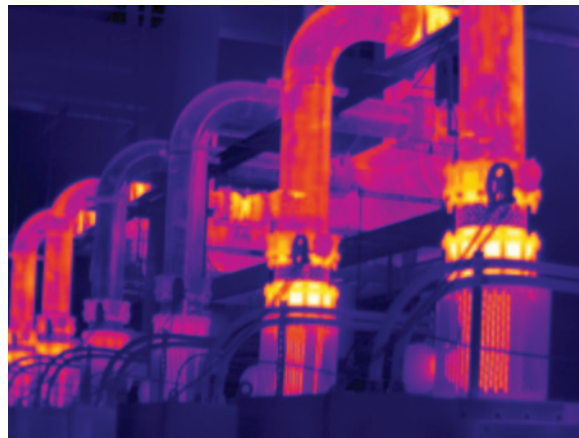

## Top 5 Pipe inspection applications

- 1 Blocked pipe
- 2 Corroded, abraded or thinning pipe
- 3 Pipe leaks
- 4 Internal heat exchanger blockage or leaks
- 5 Stove and reactor tube leaks

## Gain better visibility into piping systems with Fluke TiX5XX thermal imagers

When inspecting pipes, you're typically looking for hot spots, cold spots, or subtle temperature changes that could indicate a leak, blockage, or weakness in the pipe. If possible, it's a good idea to have a baseline image of the pipe in good condition that you can compare to subsequent images to detect problem areas more quickly. The articulating lens, 5.7 inch touchscreen, high resolution, thermal sensitivity, LaserSharp® Auto Focus, and on-camera storage on Fluke TiX5XX thermal imagers make it easier to identify a wide range of pipe problems, such as:

### Blocked pipe

A blocked pipe can cause a delta in temperature around that area that can transfer to the external pipe casing. The area beyond the blockage will show a difference in temperature due to little or no flow. Equipped with a Fluke TiX560 imager you can scan pipe from a distance, using LaserSharp® Auto Focus to get a clear image. You can add voice and text annotations, additional digital images (IR-PhotoNotes™), and put the camera into 640 x 480 SuperResolution mode to tell the whole story. You can also manually adjust the level and span to show small differences.

### Corroded, abraded, or thinning pipe

If the inside wall of the pipe is abraded, corroded, and thinning the temperature of the casing will be different than uncompromised pipe. Using the image sharpening (TiX560 only) and filter mode feature in the TiX560 and TiX520 imagers you'll be able to get a clearer view to help you find a possible weakness in the pipe.

### Pipe leaks

Sudden changes of temperature and pressure can cause excess wear and cracks in the pipe, elbows, and flanges, which may not be visible to the unaided eye. Using a TiX5XX imager you can look for temperature variations along the run of pipe. Such temperature variations can help indicate a leak, so you can record radiometric video or set alarms to collect data over time or as temperatures change. Once you identify a problem area, you can use the 640 x 480 SuperResolution (on the TiX560 imager or in SmartView software for all models), image sharpening (TiX560 only), and filter mode features (TiX560/TiX520) to see the leaks more clearly.

### Internal heat exchanger blockage or leaks

A blocked or leaking heat-exchanger tube will negatively affect heat-exchange efficiency resulting in loss of production and wasted energy. You should see a difference in temperature on either side of a blockage, or a non-standard temperature that could indicate a leak.

### Stove and reactor tube leaks

These tubes work under high-temperature, high-pressure, and strong-corrosive conditions which can cause hot spots, cracks, carburization, oxidation, and thinning. To stay on top of any damage, you can use the TiX560 to scan these tubes to find any anomalies that could indicate clogs or leaks.

## Additional tips for more effective infrared pipe inspections

To make infrared inspections most effective there are some basic practices to follow.

### Insulated pipe

If the pipe has a thick heat-insulating layer it is difficult to detect temperature variations between sections of pipe and therefore hard to detect leaks. If the insulation can be removed safely that will ensure a more effective inspection.

### High reflectivity casing

If parts of the pipe's external layer or insulation are shiny metal or stainless steel with low emissivity and inherently high reflectivity, it can interfere with getting accurate temperature measurements. If it is safe to do so in your environment, you can apply a high emissivity paint, tape, or stickers to help increase emissivity for more accurate temperature measurements.





## Fluke TiX560, TiX520 and TiX500 thermal imagers provide the first line of defense

The new Fluke TiX5XX Expert Series Thermal Imagers provide a unique set of capabilities to help you quickly identify potential issues and keep you up and running.

- 1 **Ergonomic 180° articulating lens** gives you maximum flexibility and makes it easy to navigate over, under, and around objects so you can see the image before you capture it. It allows you to verify that the image is in focus before you record it, unlike a pistol-grip imager that can be very difficult to focus when you're in an awkward position. This allows technicians to work in more ergonomically agreeable positions for all day use.
- 2 **The only 5.7 inch responsive touchscreen** in its class<sup>1</sup> delivers 150%<sup>2</sup> more viewing area to make it easy to see even subtle changes and details right on the camera. Quickly finger scroll through saved thumbnail images on the screen, zoom in and out, and access shortcuts to save time and increase productivity.
- 3 **Enhanced image quality** and temperature measurement accuracy allow you to increase 320 x 240 images to 640 x 480 in SuperResolution mode to find subtle anomalies faster.
- 4 **LaserSharp® Auto Focus** at the touch of a button takes the guesswork out of precision focus. The built-in laser distance meter calculates the distance to your designated target and then automatically focuses to produce the optimum image.
- 5 **Image Sharpening** reduces fixed pattern noise to create sharper images, particularly in high temperature environments. (On TiX560 only)
- 6 **Filter mode** achieves Noise Equivalent Temperature Difference (NETD) as low as 30 mK to detect very slight temperature differences.
- 7 **Hot and cold spot markers** highlight the hottest and coldest pixels on the image and displays their temperature values at the top of the screen for quick identification of anomalies.
- 8 **On-camera storage, editing, and analysis** allow you to store thousands of images in memory and bring them up in the field to edit, add digital images, text or voice annotations, and analyze right on the imager.
- 9 **Fluke Connect™** wireless compatibility enables you to see, save, and share live video, still images, and measurements with team members who have the Fluke Connect™ mobile app on their smart phones. Just push the shortcut button to connect.

<sup>1</sup>Compared to industrial handheld thermal imagers with 320x240 detector resolution as of September 1, 2015.

<sup>2</sup>Compared to a 3.5 inch screen.



**See and share more results at one time with Fluke Connect™ wireless capabilities**

The Fluke TiX5XX cameras are Fluke Connect-enabled so you can transmit images and measurements from the cameras to smart phones or tablets that have the Fluke Connect\* mobile app. In so doing you can share results with authorized team members and thus enhance collaboration and help resolve problems faster.



With SmartView® software, included with Fluke thermal imagers, you can run additional analyses and document findings in reports that include thermal and visible light images, and measurement data. You can adjust most parameters on the stored image, including emissivity, color palette, and level/span, just to name few.

Fluke Connect™ is not available in all countries.  
\*Within providers wireless service area.

**Work faster and easier**

Unexplained hot spots could mean trouble for your electrical system. A high resolution thermal imager is the fastest way to get a clear, accurate view of those problems. Fluke TiX560, TiX520 and TiX500 Expert Series imagers deliver the image resolution, thermal sensitivity and accuracy and ergonomic design to help you find those hot spots before they cause major damage.

To find out more, consult your Fluke sales representative or visit **www.fluke.com** for more information.

**Fluke. Keeping your world up and running®**

**Fluke Europe B.V.**  
P.O. Box 1186  
5602 BD Eindhoven  
The Netherlands  
Web: [www.fluke.co.uk](http://www.fluke.co.uk)

**For more information call:**  
In Europe/M-East/Africa  
+31 (0)40 267 5100 or  
Fax +31 (0)40 267 5222

**Fluke (UK) Ltd.**  
52 Hurricane Way  
Norwich, Norfolk  
NR6 6JB  
United Kingdom  
Tel.: +44 (0) 20 7942 0700  
Fax: +44 (0) 20 7942 0701  
E-mail: [industrial@uk.fluke.nl](mailto:industrial@uk.fluke.nl)  
Web: [www.fluke.co.uk](http://www.fluke.co.uk)

©2015 Fluke Corporation. All trademarks are the property of their respective owners. Smart phone, wireless service and data plan not included with purchase. First 5 GB of storage is free. Compatible with iPhone 4x and up running iOS 7 or higher; iPad (in an iPhone frame on iPad); Samsung Galaxy S4 running Android 4.3.x or higher and Samsung Galaxy S, Nexus 5, HTC One and One M8 running Android™ 4.4.x or higher. Apple and the Apple logo are trademarks of Apple Inc. registered in the U.S. and other countries. App Store is a service mark of Apple Inc. Google Play is a trademark of Google Inc. Printed in U.S.A. 10/2015 Pub\_ID: 13349-eng

Modification of this document is not permitted without written permission from Fluke Corporation.