

**General Description**

- Trench Power AlphaMOS-II technology
- Low  $R_{DS(ON)}$
- Low  $C_{iss}$  and  $C_{rss}$
- High Current Capability
- RoHS and Halogen Free Compliant

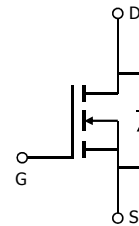
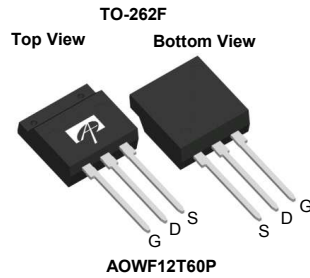
**Applications**

- General Lighting for LED and CCFL
- AC/DC Power supplies for Industrial, Consumer, and Telecom

**Product Summary**

$V_{DS} @ T_{j,max}$	700V
$I_{DM}$	48A
$R_{DS(ON),max}$	< 0.52 $\Omega$
$Q_{g,typ}$	33nC
$E_{oss} @ 400V$	4.4 $\mu$ J

100% UIS Tested  
100%  $R_g$  Tested



Orderable Part Number	Package Type	Form	Minimum Order Quantity
AOWF12T60P	TO-262F	Tube	1000

**Absolute Maximum Ratings  $T_A=25^\circ\text{C}$  unless otherwise noted**

Parameter	Symbol	Maximum	Units
Drain-Source Voltage	$V_{DS}$	600	V
Gate-Source Voltage	$V_{GS}$	$\pm 30$	V
Continuous Drain Current	$I_D$	$T_C=25^\circ\text{C}$	12*
		$T_C=100^\circ\text{C}$	9*
Pulsed Drain Current <sup>C</sup>	$I_{DM}$	48	A
Avalanche Current <sup>C</sup> L=1mH	$I_{AR}$	12	A
Repetitive avalanche energy <sup>C</sup>	$E_{AR}$	72	mJ
Single pulsed avalanche energy <sup>G</sup>	$E_{AS}$	750	mJ
MOSFET dv/dt ruggedness	dv/dt	50	V/ns
Peak diode recovery dv/dt <sup>J</sup>		15	
Power Dissipation <sup>B</sup>	$P_D$	$T_C=25^\circ\text{C}$	28
		Derate above 25 $^\circ\text{C}$	0.2
Junction and Storage Temperature Range	$T_J, T_{STG}$	-55 to 150	$^\circ\text{C}$
Maximum lead temperature for soldering purpose, 1/8" from case for 5 seconds	$T_L$	300	$^\circ\text{C}$

**Thermal Characteristics**

Parameter	Symbol	Maximum	Units
Maximum Junction-to-Ambient <sup>A,D</sup>	$R_{\theta JA}$	65	$^\circ\text{C/W}$
Maximum Junction-to-Case	$R_{\theta JC}$	4.5	$^\circ\text{C/W}$

\* Drain current limited by maximum junction temperature.

**Electrical Characteristics (T<sub>J</sub>=25°C unless otherwise noted)**

Symbol	Parameter	Conditions	Min	Typ	Max	Units
<b>STATIC PARAMETERS</b>						
BV <sub>DSS</sub>	Drain-Source Breakdown Voltage	I <sub>D</sub> =250μA, V <sub>GS</sub> =0V, T <sub>J</sub> =25°C	600			V
		I <sub>D</sub> =250μA, V <sub>GS</sub> =0V, T <sub>J</sub> =150°C		700		
BV <sub>DSS</sub> /ΔT <sub>J</sub>	Breakdown Voltage Temperature Coefficient	I <sub>D</sub> =250μA, V <sub>GS</sub> =0V		0.58		V/°C
I <sub>DSS</sub>	Zero Gate Voltage Drain Current	V <sub>DS</sub> =600V, V <sub>GS</sub> =0V			1	μA
		V <sub>DS</sub> =480V, T <sub>J</sub> =125°C			10	
I <sub>GSS</sub>	Gate-Body leakage current	V <sub>DS</sub> =0V, V <sub>GS</sub> =±30V			±100	nA
V <sub>GS(th)</sub>	Gate Threshold Voltage	V <sub>DS</sub> =5V, I <sub>D</sub> =250μA	3	4.1	5	V
R <sub>DS(ON)</sub>	Static Drain-Source On-Resistance	V <sub>GS</sub> =10V, I <sub>D</sub> =6A		0.44	0.52	Ω
g <sub>FS</sub>	Forward Transconductance	V <sub>DS</sub> =40V, I <sub>D</sub> =6A		11		S
V <sub>SD</sub>	Diode Forward Voltage	I <sub>S</sub> =1A, V <sub>GS</sub> =0V		0.73	1	V
I <sub>S</sub>	Maximum Body-Diode Continuous Current				12	A
I <sub>SM</sub>	Maximum Body-Diode Pulsed Current <sup>C</sup>				48	A
<b>DYNAMIC PARAMETERS</b>						
C <sub>iss</sub>	Input Capacitance	V <sub>GS</sub> =0V, V <sub>DS</sub> =100V, f=1MHz		2028		pF
C <sub>oss</sub>	Output Capacitance				71	
C <sub>o(er)</sub>	Effective output capacitance, energy related <sup>H</sup>	V <sub>GS</sub> =0V, V <sub>DS</sub> =0 to 480V, f=1MHz		52		pF
C <sub>o(tr)</sub>	Effective output capacitance, time related <sup>I</sup>				94	
C <sub>rss</sub>	Reverse Transfer Capacitance	V <sub>GS</sub> =0V, V <sub>DS</sub> =100V, f=1MHz		13		pF
R <sub>g</sub>	Gate resistance	f=1MHz		2.2		Ω
<b>SWITCHING PARAMETERS</b>						
Q <sub>g</sub>	Total Gate Charge	V <sub>GS</sub> =10V, V <sub>DS</sub> =480V, I <sub>D</sub> =12A		33	50	nC
Q <sub>gs</sub>	Gate Source Charge			13		nC
Q <sub>gd</sub>	Gate Drain Charge			10		nC
t <sub>D(on)</sub>	Turn-On DelayTime	V <sub>GS</sub> =10V, V <sub>DS</sub> =300V, I <sub>D</sub> =12A, R <sub>G</sub> =25Ω		52		ns
t <sub>r</sub>	Turn-On Rise Time			72		ns
t <sub>D(off)</sub>	Turn-Off DelayTime			66		ns
t <sub>f</sub>	Turn-Off Fall Time			42		ns
t <sub>rr</sub>	Body Diode Reverse Recovery Time	I <sub>F</sub> =12A, di/dt=100A/μs, V <sub>DS</sub> =100V		483		ns
Q <sub>rr</sub>	Body Diode Reverse Recovery Charge	I <sub>F</sub> =12A, di/dt=100A/μs, V <sub>DS</sub> =100V		7		μC

A. The value of R<sub>θJA</sub> is measured with the device in a still air environment with T<sub>A</sub>=25°C.

B. The power dissipation P<sub>D</sub> is based on T<sub>J(MAX)</sub>=150°C, using junction-to-case thermal resistance, and is more useful in setting the upper dissipation limit for cases where additional heatsinking is used.

C. Repetitive rating, pulse width limited by junction temperature T<sub>J(MAX)</sub>=150°C. Ratings are based on low frequency and duty cycles to keep initial T<sub>J</sub>=25°C.

D. The R<sub>θJA</sub> is the sum of the thermal impedance from junction to case R<sub>θJC</sub> and case to ambient.

E. The static characteristics in Figures 1 to 6 are obtained using <300 ms pulses, duty cycle 0.5% max.

F. These curves are based on the junction-to-case thermal impedance which is measured with the device mounted to a large heatsink, assuming a maximum junction temperature of T<sub>J(MAX)</sub>=150°C. The SOA curve provides a single pulse rating.

G. L=60mH, I<sub>AS</sub>=5A, V<sub>DD</sub>=150V, R<sub>G</sub>=25Ω, Starting T<sub>J</sub>=25°C.

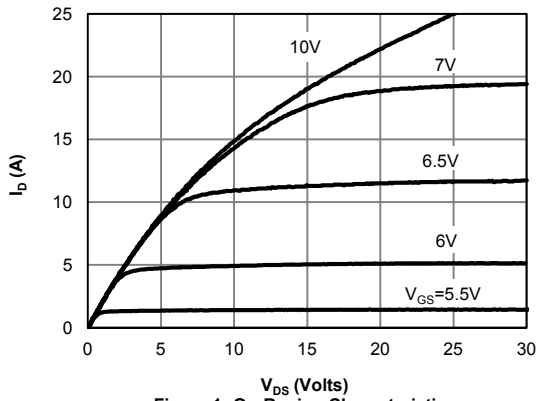
H. C<sub>o(er)</sub> is a fixed capacitance that gives the same stored energy as C<sub>oss</sub> while V<sub>DS</sub> is rising from 0 to 80% V<sub>(BR)DSS</sub>.

I. C<sub>o(tr)</sub> is a fixed capacitance that gives the same charging time as C<sub>oss</sub> while V<sub>DS</sub> is rising from 0 to 80% V<sub>(BR)DSS</sub>.

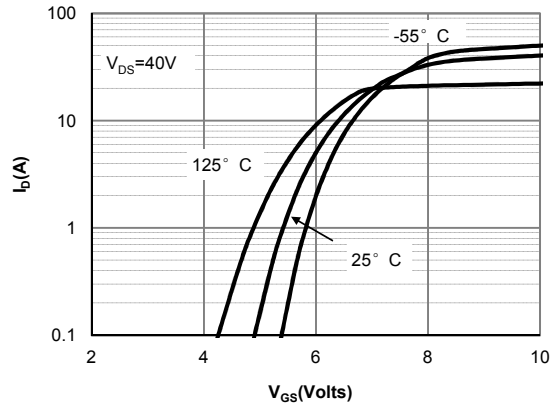
J. I<sub>SD</sub>≤I<sub>D</sub>, di/dt≤200A/μs, V<sub>DD</sub>=400V, T<sub>J</sub>≤T<sub>J(MAX)</sub>.

THIS PRODUCT HAS BEEN DESIGNED AND QUALIFIED FOR THE CONSUMER MARKET. APPLICATIONS OR USES AS CRITICAL COMPONENTS IN LIFE SUPPORT DEVICES OR SYSTEMS ARE NOT AUTHORIZED. AOS DOES NOT ASSUME ANY LIABILITY ARISING OUT OF SUCH APPLICATIONS OR USES OF ITS PRODUCTS. AOS RESERVES THE RIGHT TO IMPROVE PRODUCT DESIGN, FUNCTIONS AND RELIABILITY WITHOUT NOTICE.

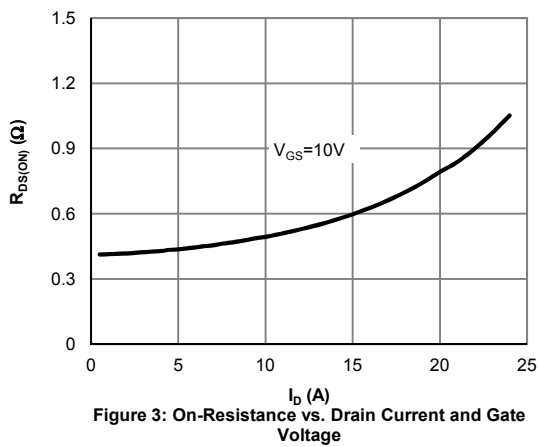
**TYPICAL ELECTRICAL AND THERMAL CHARACTERISTICS**



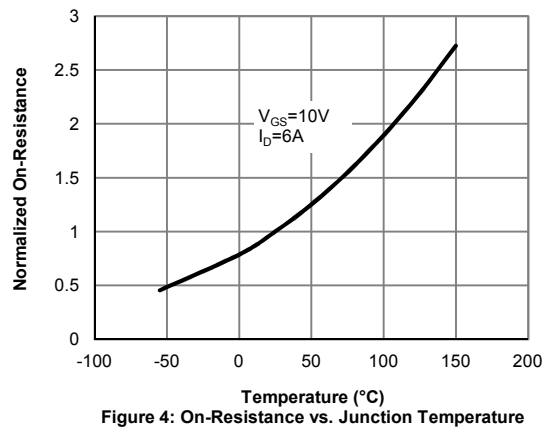
**Figure 1: On-Region Characteristics**



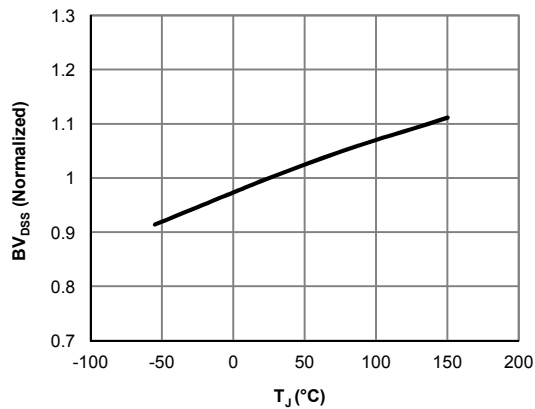
**Figure 2: Transfer Characteristics**



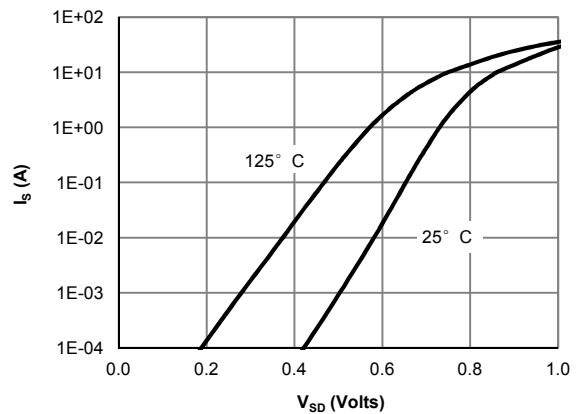
**Figure 3: On-Resistance vs. Drain Current and Gate Voltage**



**Figure 4: On-Resistance vs. Junction Temperature**

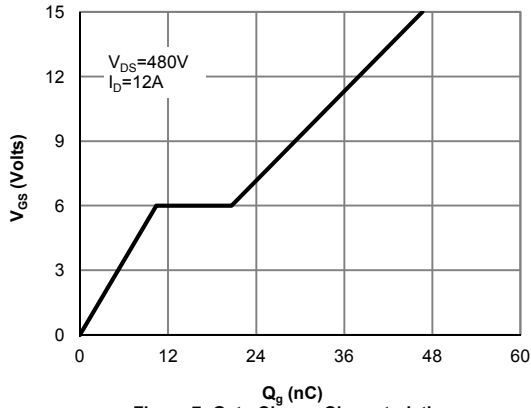


**Figure 5: Break Down vs. Junction Temperature**

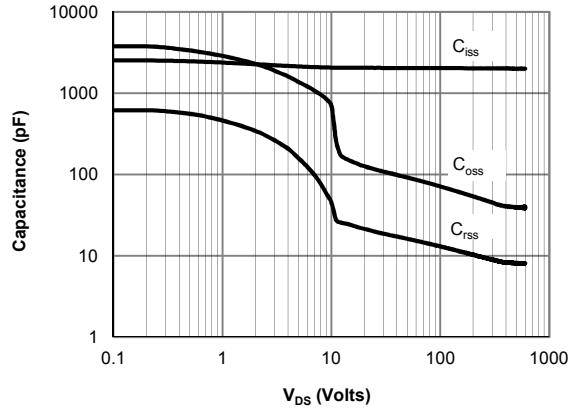


**Figure 6: Body-Diode Characteristics**

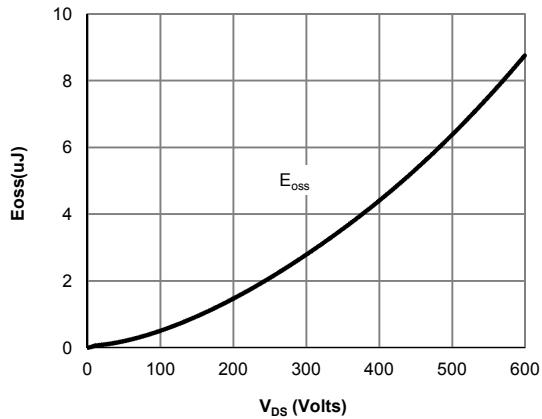
**TYPICAL ELECTRICAL AND THERMAL CHARACTERISTICS**



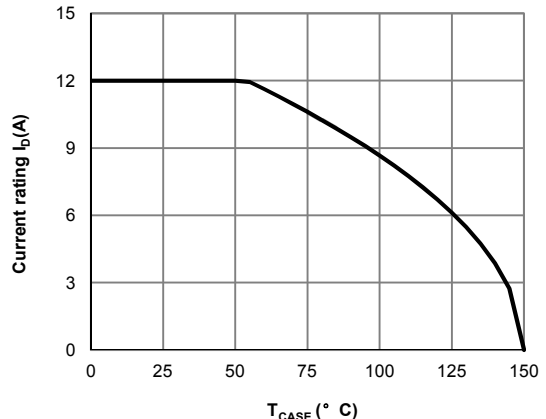
**Figure 7: Gate-Charge Characteristics**



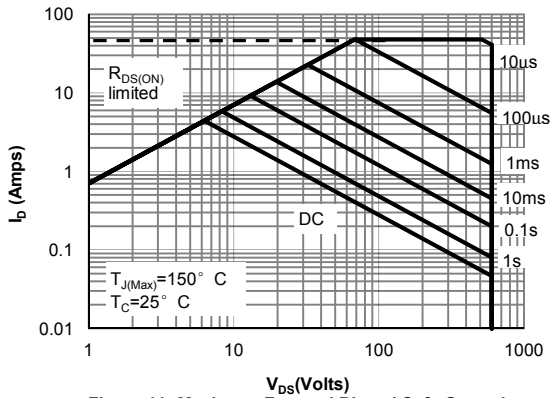
**Figure 8: Capacitance Characteristics**



**Figure 9: Coss stored Energy**



**Figure 10: Current De-rating (Note F)**



**Figure 11: Maximum Forward Biased Safe Operating Area for TO-262F (Note F)**

**TYPICAL ELECTRICAL AND THERMAL CHARACTERISTICS**

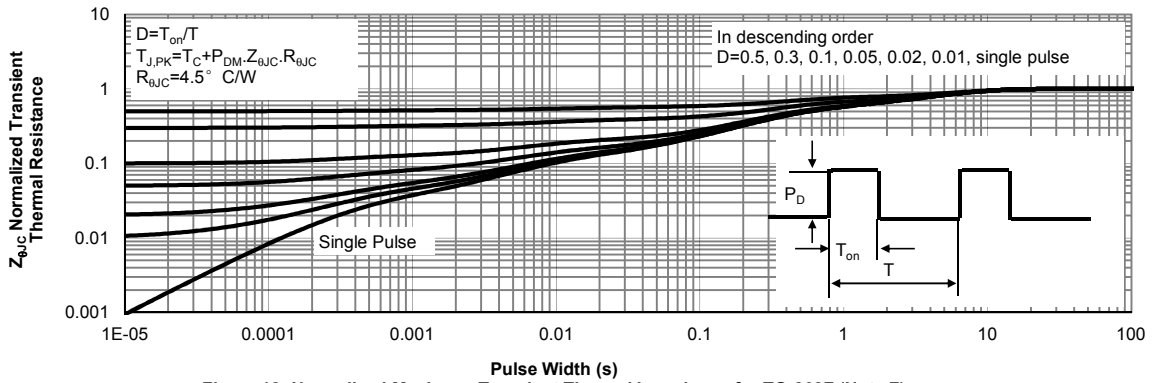
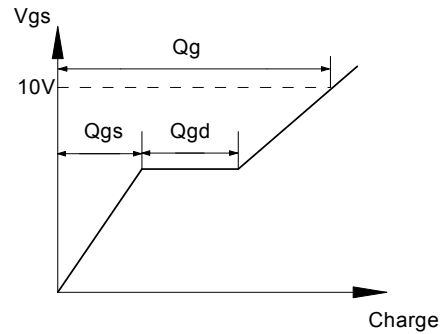
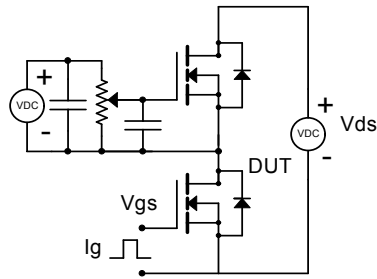
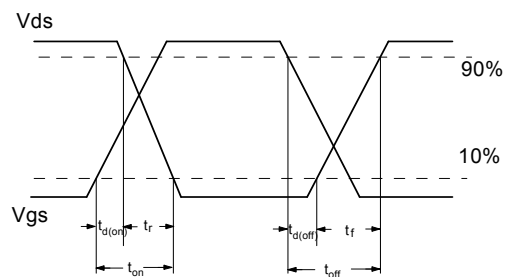
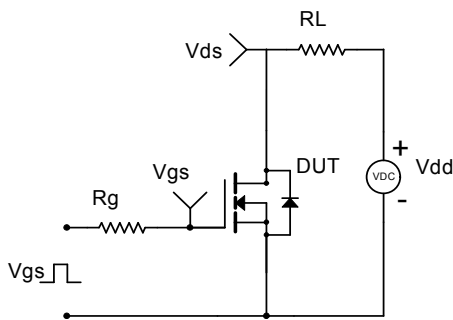


Figure 12: Normalized Maximum Transient Thermal Impedance for TO-262F (Note F)

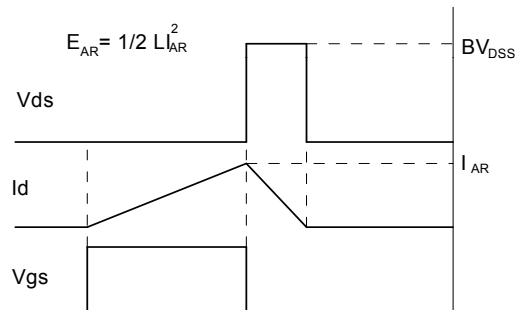
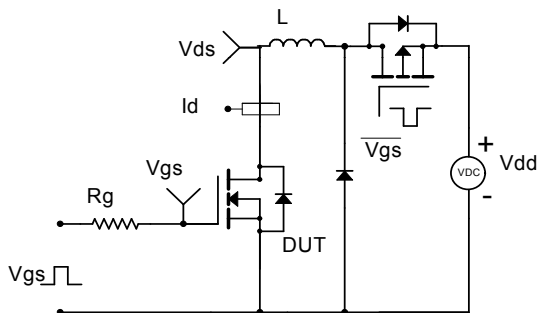
Gate Charge Test Circuit & Waveform



Resistive Switching Test Circuit & Waveforms



Unclamped Inductive Switching (UIS) Test Circuit & Waveforms



Diode Recovery Test Circuit & Waveforms

