

## SPECIFICATIONS SDTA28A2W

### MECHANICAL DIMENSIONS

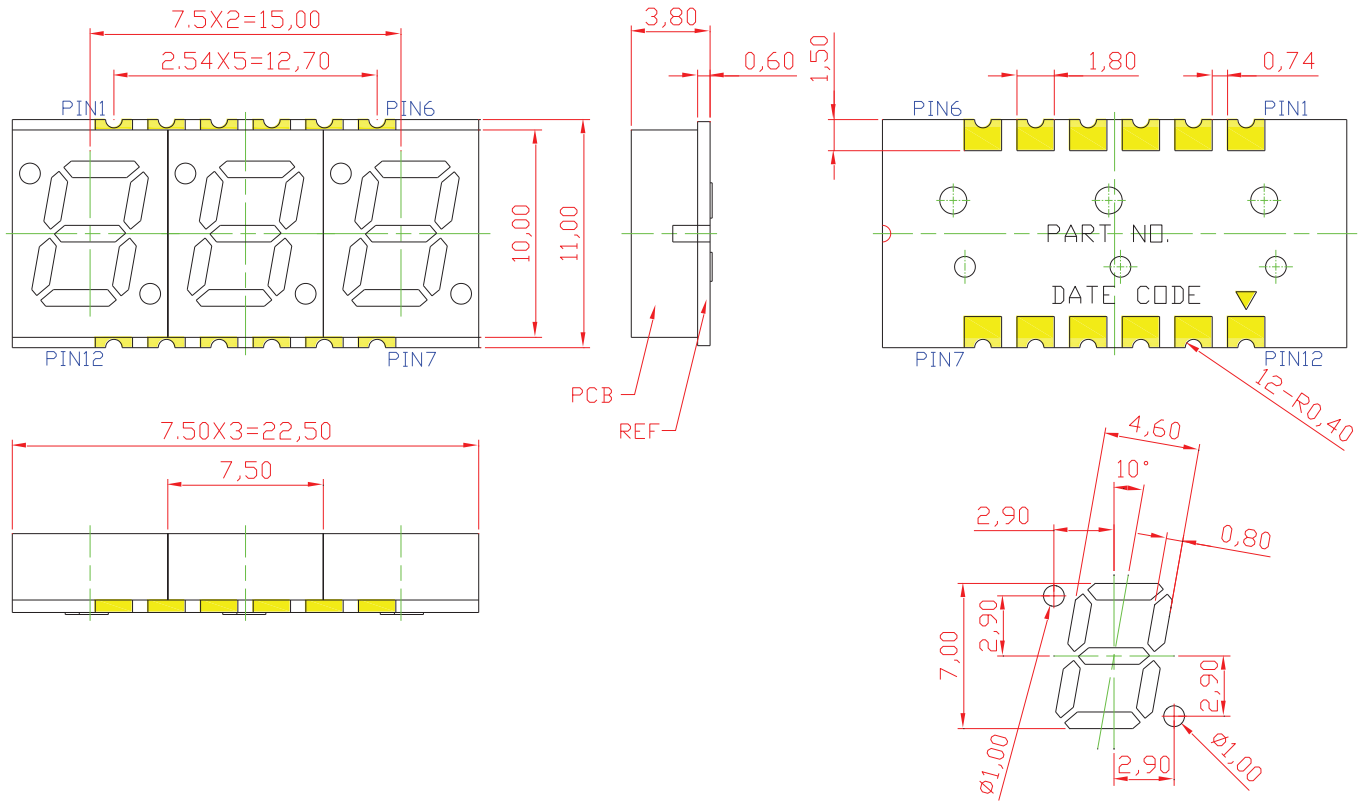

- Notes:**
1. All dimensions are in millimeters (inches).
  2. Tolerance is  $\pm 0.25\text{mm}$  (0.01") unless otherwise noted.
  3. Specifications are subject to change without notice.

Part Number	Chip Material	Color of Emission	Lens Type	Description
SDTA28A2W	InGaAlP	Amber	White Segment	Common Anode

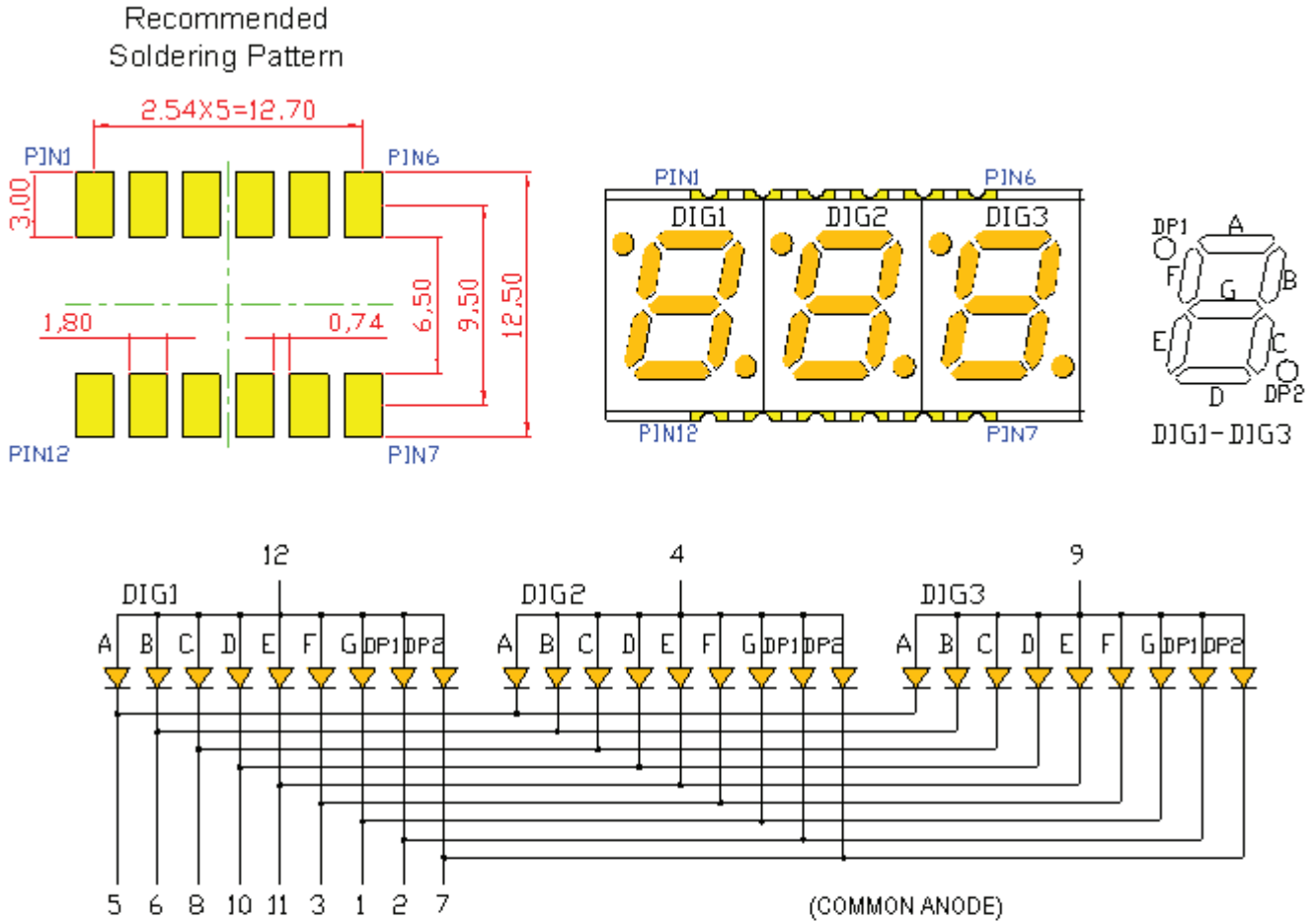

ChromeLED Corp. reserves the right to make changes at any time in order to supply the best product possible. The most current version of this document will always be available at: [www.chromeled.com](http://www.chromeled.com)

**SPECIFICATIONS**
**TYPICAL INTERNAL EQUIVALENT CIRCUIT**

**Notes:**

1. All dimensions are in millimeters (inches).
2. Tolerance is  $\pm 0.25\text{mm}$  (0.01") unless otherwise noted.
3. Specifications are subject to change without notice.



ChromeLED Corp. reserves the right to make changes at any time in order to supply the best product possible. The most current version of this document will always be available at: [www.chromeled.com](http://www.chromeled.com)

**ABSOLUTE MAXIMUM RATINGS**
**(TA=25°C)**

Parameter	Symbol		Unit
Power Dissipation per Dice	PAD	70	mW
Derating Liner from 25°C per Dice	-	0.28	mA / °C
Continuous Forward Current per Dice	IAF	25	mA
Peak Current per Dice (duty cycle 1/10, 1kHz)	IPF	90	mA
Reverse Voltage per Dice	VR	5	°C
Operating Temperature	TOPR	-40~+105	°C
Storage Temperature	TSTG	-40~+105	°C

**OPTICAL-ELECTRICAL CHARACTERISTICS**
**(TA=25°C)**

Characteristic	Symbol	Condition	Value			Unit
			Min.	Type.	Max.	
Forward Voltage per Dice	VF	IF =20mA		2.0	2.6	V
Reverse Current per Dice	IR	VR = 5V		-	10	µA
Peak Wavelength per Dice	λP	IF =20mA	-	612	-	nm
Dominant Wavelength per Dice	λD	IF =20mA	-	610	-	nm
Luminous Intensity	IV	IF =20mA	-	10	-	mcd
Spectral Radiation Bandwidth per Dice	Δλ	IF =20mA	-	20		nm

\*Tolerance of viewing angle: -10 / +5 deg.



ChromeLED Corp. reserves the right to make changes at any time in order to supply the best product possible. The most current version of this document will always be available at: [www.chromeled.com](http://www.chromeled.com)

## OPTICAL CHARACTERISTIC CURVES

(25 °C Free Air Temperature Unless Otherwise Specified)

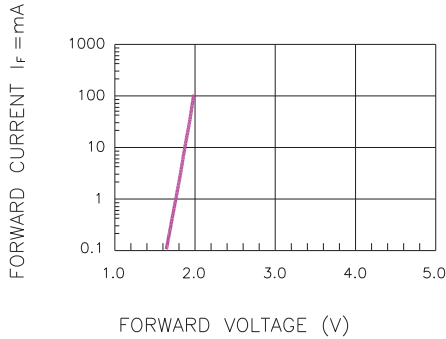

Fig.1 FORWARD CURRENT VS. FORWARD VOLTAGE

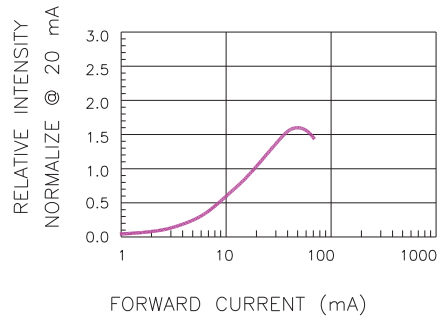

Fig.2 RELATIVE INTENSITY VS. FORWARD CURRENT

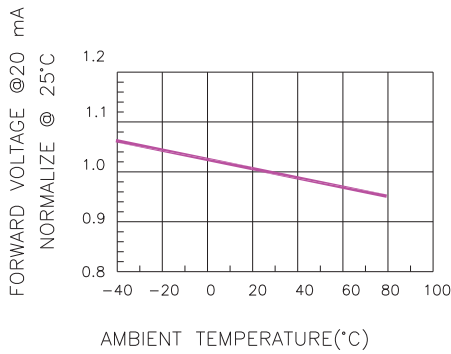

Fig.3 FORWARD VOLTAGE VS. TEMPERATURE

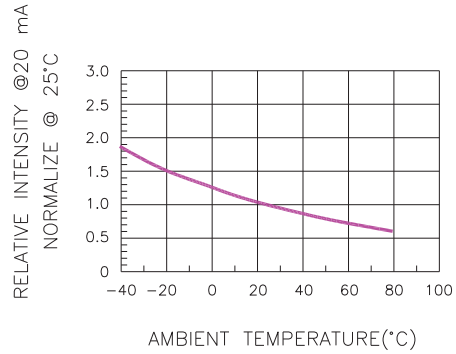

Fig.4 RELATIVE INTENSITY VS. TEMPERATURE

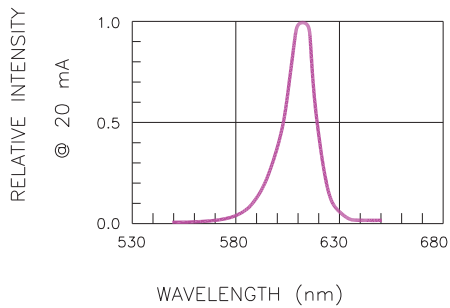

Fig.5 RELATIVE INTENSITY VS. WAVELENGTH

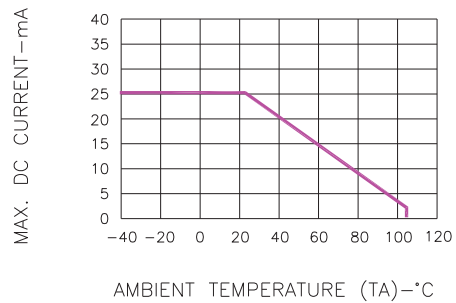

Fig.6 MAX. ALLOWABLE DC CURRENT VS. AMBIENT TEMPERATURE



ChromeLED Corp. reserves the right to make changes at any time in order to supply the best product possible. The most current version of this document will always be available at: [www.chromeled.com](http://www.chromeled.com)

**SOLDERING CONDITIONS – SMD TYPE LED**
**● RECOMMEND SOLDERING PROFILE**

SMT Soldering Profile  
 Pb free reflow soldering Profile

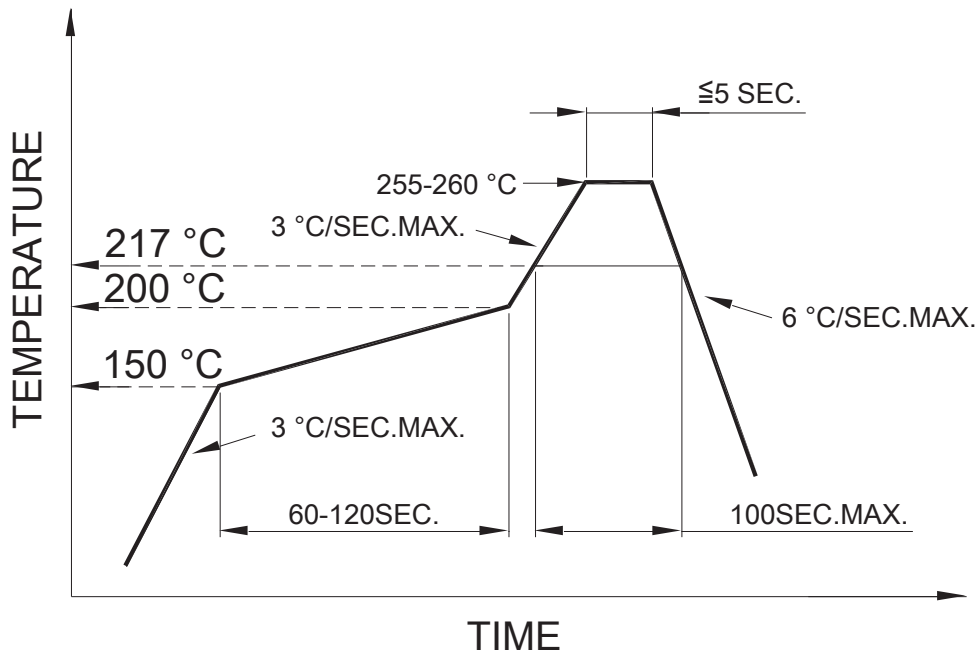
**● SOLDERING IRON**

Basic specification : ≤ 4 seconds when 260°C, If temperature is higher, time should be shorter (+10°C → 1 sec). Power dissipation of iron should be smaller than 15W, and temperature should be controllable. Surface temperature of the device should be under 230°C.

**● REWORK**

Customer must finish rework within ≤ 3 sec under 350°C.



ChromeLED Corp. reserves the right to make changes at any time in order to supply the best product possible. The most current version of this document will always be available at: [www.chromeled.com](http://www.chromeled.com)