

**Data sheet | Item number: 2086-1102**

THR PCB terminal block; push-button; 1.5 mm<sup>2</sup>; Pin spacing 3.5 mm; 2-pole;  
Push-in CAGE CLAMP®; 1,50 mm<sup>2</sup>; black

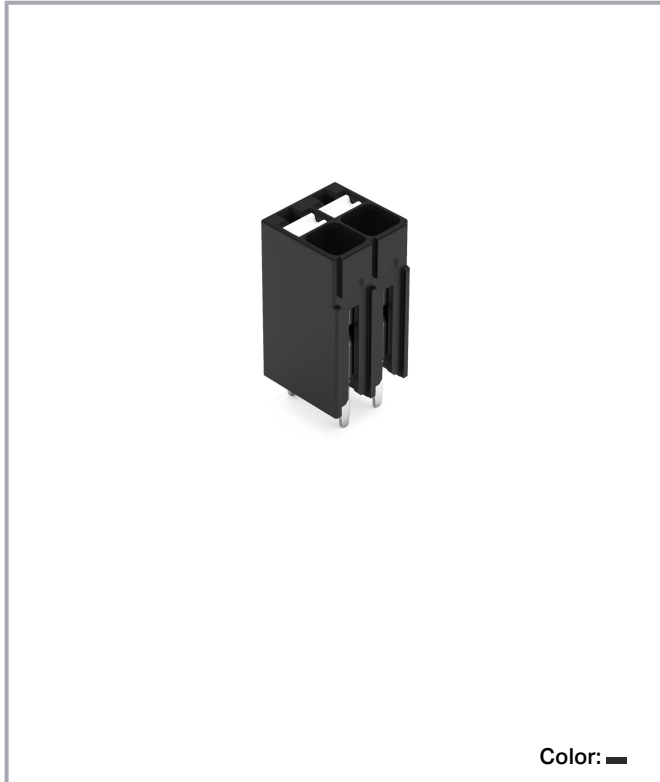

[www.wago.com/2086-1102](http://www.wago.com/2086-1102)



Subject to changes. Please also observe the further product documentation!

WAGO Corporation  
Germantown, WI 53022  
Phone: 1-800-DIN-RAIL (346-7245) | Fax: (262) 255-6222  
Email: [info.us@wago.com](mailto:info.us@wago.com) | Web: [www.wago.us](http://www.wago.us)

Do you have any questions about our products?  
We are always happy to take your call at (262) 255-6222 or 1 800-DIN-RAIL.

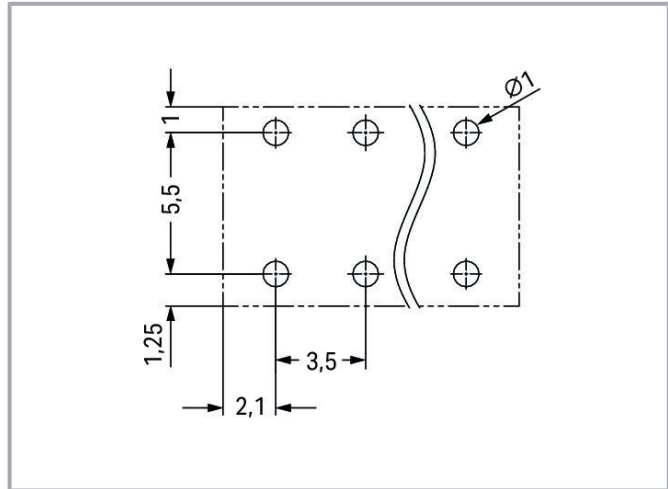

Dimensions in mm

$L = (\text{pole no.} - 1) \times \text{pin spacing} + 4.2 \text{ mm}$

## Item description

- Ideal for compact device connection, panel feedthrough and tight spaces
- Push-in CAGE CLAMP® allows push-in termination of solid and fine-stranded conductors with ferrules
- SMD and THR variants available
- Delivery in tape-and-reel packaging for full integration into SMT soldering process
- Push-button moves in direction of conductor connection
- Conductor connection and mating direction both parallel and perpendicular to the PCB
- Choice of double pin spacing or alternating pin spacing, 3.5 and 5 mm pin spacing

Subject to changes. Please also observe the further product documentation!

WAGO Corporation  
Germantown, WI 53022  
Phone: 1-800-DIN-RAIL (346-7245) | Fax: (262) 255-6222  
Email: [info.us@wago.com](mailto:info.us@wago.com) | Web: [www.wago.us](http://www.wago.us)

Do you have any questions about our products?  
We are always happy to take your call at (262) 255-6222 or 1 800-DIN-RAIL.



## Data

### Electrical data

#### IEC Approvals

Ratings per	IEC/EN 60664-1
Rated voltage (III / 3)	160 V
Rated surge voltage (III/3)	2.5 kV
Rated voltage (III/2)	160 V
Rated surge voltage (III/2)	2.5 kV
Nominal voltage (II/2)	320 V
Rated surge voltage (II/2)	2.5 kV
Rated current	17.5 A
Legend (ratings)	(III / 2) ≙ Overvoltage category III / Pollution degree 2

#### UL Approvals

Approvals per	UL 1059
Rated voltage UL (Use Group B)	300 V
Rated current UL (Use Group B)	10 A
Rated voltage UL (Use Group C)	300 V
Rated current UL (Use Group C)	10 A
Rated voltage UL (Use Group D)	300 V
Rated current UL (Use Group D)	10 A

#### CSA Approvals

Approvals per	CSA
Rated voltage CSA (Use Group B)	300 V
Rated current CSA (Use Group B)	10 A
Rated voltage CSA (Use Group D)	300 V
Rated current CSA (Use Group D)	10 A

#### Connection data

Total number of potentials	2
Number of connection types	1
Number of levels	1

Subject to changes. Please also observe the further product documentation!

WAGO Corporation  
 Germantown, WI 53022  
 Phone: 1-800-DIN-RAIL (346-7245) | Fax: (262) 255-6222  
 Email: [info.us@wago.com](mailto:info.us@wago.com) | Web: [www.wago.us](http://www.wago.us)

Do you have any questions about our products?  
 We are always happy to take your call at (262) 255-6222 or 1 800-DIN-RAIL.



## Connection 1

Connection technology	Push-in CAGE CLAMP®
Actuation type	Push-button
Solid conductor	0.14 ... 1.5 mm <sup>2</sup> / 24 ... 16 AWG
Fine-stranded conductor	0.14 ... 1.5 mm <sup>2</sup> / 24 ... 16 AWG
Fine-stranded conductor; with insulated ferrule	0.25 ... 0.75 mm <sup>2</sup>
Fine-stranded conductor; with uninsulated ferrule	0.25 ... 1.5 mm <sup>2</sup>
Strip length	8 ... 9 mm / 0.31 ... 0.35 inch
Conductor connection direction to PCB	90°
Number of poles	2

## Physical data

Pin spacing	3.5 mm / 0.138 inch
Width	7.7 mm / 0.303 inch
Height	16 mm / 0.63 inch
Height from the surface	13.6 mm / 0.535 inch
Depth	7.8 mm / 0.307 inch
Solder pin length	2.4 mm
Solder pin dimensions	0.3 x 0.8 mm
Plated through-hole diameter (THR)	1 <sup>(+0.1)</sup> mm

## PCB contact

PCB Contact	THR
Solder pin arrangement	Over the entire terminal strip (in-line)
Number of solder pins per potential	2

## Material data

Color	black
Insulation material	Polyphthalamide (PPA GF)
Flammability class per UL94	V0
Clamping spring material	Chrome nickel spring steel (CrNi)
Contact material	Electrolytic copper (E <sub>Cu</sub> )
Contact plating	Tin-plated
Weight	1 g

Subject to changes. Please also observe the further product documentation!

WAGO Corporation  
 Germantown, WI 53022  
 Phone: 1-800-DIN-RAIL (346-7245) | Fax: (262) 255-6222  
 Email: [info.us@wago.com](mailto:info.us@wago.com) | Web: [www.wago.us](http://www.wago.us)

Do you have any questions about our products?  
 We are always happy to take your call at (262) 255-6222 or 1 800-DIN-RAIL.

## Environmental requirements



Limit temperature range	-60 ... +105 °C
-------------------------	-----------------

## Commercial data

PU (SPU)	432 Stück
Packaging type	BOX
Country of origin	CH
GTIN	4055144089226
Customs tariff number	85369010000

## Approvals / Certificates

### Country specific Approvals

Logo	Approval	Additional Approval Text	Certificate name
	<b>CB</b> DEKRA Certification B.V.	IEC 60947-7-4	NL-74022
	<b>CSA</b> DEKRA Certification B.V.	C22.2	80060692
	<b>KEMA/KEUR</b> DEKRA Certification B.V.	EN 60947-7-4	71- 119449

### UL-Approvals

Logo	Approval	Additional Approval Text	Certificate name
	<b>UL</b> Underwriters Laboratories Inc.	UL 1059	E45172

## Optional accessories

### Testing accessories

Testing accessories	
 <b>Item no.: 735-500</b> Test pin; 1 mm Ø; with solder connection for test wire	<a href="http://www.wago.com/735-500">www.wago.com/735-500</a>

Subject to changes. Please also observe the further product documentation!



**Item no.: 859-500**  
Test pin; 1 mm Ø; with solder connection for test wire

[www.wago.com/859-500](http://www.wago.com/859-500)

**Tools**

Operating tool



**Item no.: 210-719**  
Operating tool; Blade: 2.5 x 0.4 mm; with a partially insulated shaft

[www.wago.com/210-719](http://www.wago.com/210-719)

**Ferrules**

Ferrule



**Item no.: 216-101**  
Ferrule; Sleeve for 0.5 mm<sup>2</sup> / AWG 22; uninsulated; electro-tin plated; silver-colored

[www.wago.com/216-101](http://www.wago.com/216-101)



**Item no.: 216-104**  
Ferrule; Sleeve for 1.5 mm<sup>2</sup> / AWG 16; uninsulated; electro-tin plated; silver-colored

[www.wago.com/216-104](http://www.wago.com/216-104)



**Item no.: 216-102**  
Ferrule; Sleeve for 0.75 mm<sup>2</sup> / AWG 20; uninsulated; electro-tin plated; silver-colored

[www.wago.com/216-102](http://www.wago.com/216-102)



**Item no.: 216-103**  
Ferrule; Sleeve for 1 mm<sup>2</sup> / AWG 18; uninsulated; electro-tin plated

[www.wago.com/216-103](http://www.wago.com/216-103)



**Item no.: 216-142**  
Ferrule; Sleeve for 0.75 mm<sup>2</sup> / 18 AWG; uninsulated; electro-tin plated; electrolytic copper; gastight crimped; acc. to DIN 46228, Part 1/08.92

[www.wago.com/216-142](http://www.wago.com/216-142)



**Item no.: 216-132**  
Ferrule; Sleeve for 0.34 mm<sup>2</sup> / AWG 24; uninsulated; electro-tin plated

[www.wago.com/216-132](http://www.wago.com/216-132)



**Item no.: 216-121**  
Ferrule; Sleeve for 0.5 mm<sup>2</sup> / AWG 22; uninsulated; electro-tin plated; silver-colored

[www.wago.com/216-121](http://www.wago.com/216-121)



**Item no.: 216-143**  
Ferrule; Sleeve for 1 mm<sup>2</sup> / AWG 18; uninsulated; electro-tin plated; electrolytic copper; gastight crimped; acc. to DIN 46228, Part 1/08.92

[www.wago.com/216-143](http://www.wago.com/216-143)



**Item no.: 216-131**  
Ferrule; Sleeve for 0.25 mm<sup>2</sup> / AWG 24; uninsulated; electro-tin plated; silver-colored

[www.wago.com/216-131](http://www.wago.com/216-131)



**Item no.: 216-141**  
Ferrule; Sleeve for 0.5 mm<sup>2</sup> / 20 AWG; uninsulated; electro-tin plated; electrolytic copper; gastight crimped; acc. to DIN 46228, Part 1/08.92

[www.wago.com/216-141](http://www.wago.com/216-141)



**Item no.: 216-152**  
Ferrule; Sleeve for 0.34 mm<sup>2</sup> / AWG 24; uninsulated; electro-tin plated

[www.wago.com/216-152](http://www.wago.com/216-152)



**Item no.: 216-202**  
Ferrule; Sleeve for 0.75 mm<sup>2</sup> / 18 AWG; insulated; electro-tin plated; gray

[www.wago.com/216-202](http://www.wago.com/216-202)



**Item no.: 216-151**  
Ferrule; Sleeve for 0.25 mm<sup>2</sup> / AWG 24; uninsulated; electro-tin plated

[www.wago.com/216-151](http://www.wago.com/216-151)



**Item no.: 216-144**  
Ferrule; Sleeve for 1.5 mm<sup>2</sup> / AWG 16; uninsulated; electro-tin plated; electrolytic copper; gastight crimped; acc. to DIN 46228, Part 1/08.92; silver-colored





[www.wago.com/216-144](http://www.wago.com/216-144)

Subject to changes. Please also observe the further product documentation!

WAGO Corporation  
Germantown, WI 53022  
Phone: 1-800-DIN-RAIL (346-7245) | Fax: (262) 255-6222  
Email: [info.us@wago.com](mailto:info.us@wago.com) | Web: [www.wago.us](http://www.wago.us)

Do you have any questions about our products?  
We are always happy to take your call at (262) 255-6222 or 1 800-DIN-RAIL.



	<b>Item no.: 216-201</b> Ferrule; Sleeve for 0.5 mm <sup>2</sup> / 20 AWG; insulated; electro-tin plated; white	<a href="http://www.wago.com/216-201">www.wago.com/216-201</a>
	<b>Item no.: 216-241</b> Ferrule; Sleeve for 0.5 mm <sup>2</sup> / 20 AWG; insulated; electro-tin plated; electrolytic copper; gastight crimped; acc. to DIN 46228, Part 4/09.90; white	<a href="http://www.wago.com/216-241">www.wago.com/216-241</a>
	<b>Item no.: 216-242</b> Ferrule; Sleeve for 0.75 mm <sup>2</sup> / 18 AWG; insulated; electro-tin plated; electrolytic copper; gastight crimped; acc. to DIN 46228, Part 4/09.90; gray	<a href="http://www.wago.com/216-242">www.wago.com/216-242</a>
	<b>Item no.: 216-301</b> Ferrule; Sleeve for 0.25 mm <sup>2</sup> / AWG 24; insulated; electro-tin plated; yellow	<a href="http://www.wago.com/216-301">www.wago.com/216-301</a>
	<b>Item no.: 216-302</b> Ferrule; Sleeve for 0.34 mm <sup>2</sup> / 22 AWG; insulated; electro-tin plated; green	<a href="http://www.wago.com/216-302">www.wago.com/216-302</a>

## Downloads

### Documentation

#### Additional Information

Technical explanations	Apr 3, 2019	pdf 2.0 MB	Download
THR Soldering Process		pdf 548.2 kB	Download

## CAD files

### CAD data

2D/3D Models 2086-1102	URL	Download
------------------------	-----	----------

### CAE data

ZUKEN Portal 2086-1102	URL	Download
------------------------	-----	----------

## Environmental Product Compliance

### Compliance Search

Environmental Product Compliance 2086-1102 THR PCB terminal block; push-button; 1.5 mm <sup>2</sup> ; Pin spacing 3.5 mm; 2-pole; Push-in CAGE CLAMP®; 1,50 mm <sup>2</sup> ; black	URL	Download
--	-----	----------

## Installation Notes

Subject to changes. Please also observe the further product documentation!

WAGO Corporation  
Germantown, WI 53022  
Phone: 1-800-DIN-RAIL (346-7245) | Fax: (262) 255-6222  
Email: [info.us@wago.com](mailto:info.us@wago.com) | Web: [www.wago.us](http://www.wago.us)

Do you have any questions about our products?  
We are always happy to take your call at (262) 255-6222 or 1 800-DIN-RAIL.

### Conductor termination



Inserting solid conductor via push-in termination.

### Conductor removal



Removing fine-stranded conductors via push-buttons.

### Conductor termination

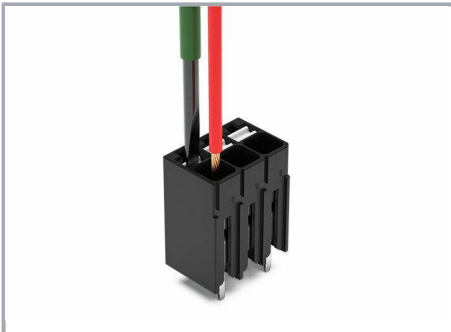

Inserting and removing fine-stranded conductors via push-buttons.

### Testing

Subject to changes. Please also observe the further product documentation!



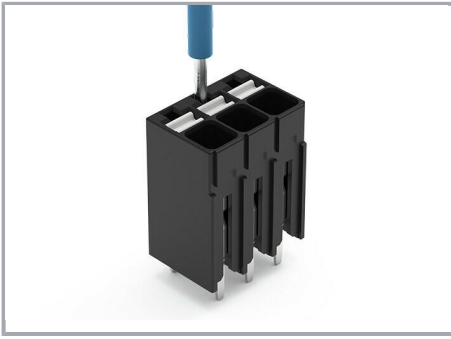

Testing via 1 mm Ø test pin.

Touch contact with current bar.

### Marking



Pole marking via direct marking  
perpendicular to conductor entry.

Subject to changes. Please also observe the further product documentation!