



1214GN-15E

15 Watts • 50 Volts • 4.5mS, 35%
1200–1400MHz

E Class Earless Driver GaN Transistor – Key Features

- 1200-1400MHz • 15W Output Power • CW and Pulsed
- Common Source • Class AB • 50VDD Bias Voltage
- >60% Efficiency Across the Frequency Band
- Extremely Compact Size
- 17.8 dB Typical Power Gain
- 0.3 dB Typical Excellent Gain Flatness
- L-Band Radars, Communication, Industrial, General Purpose
- All gold metallization and eutectic die attach for highest reliability
- 50Ω in/out lumped element very small footprint plug & play pallets available

CASE/PALLET OUTLINES

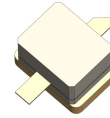

55-QQP
(0.160" x 0.230")

ABSOLUTE MAXIMUM RATINGS

Maximum Power Dissipation

Device Dissipation @ 25°C 34 W

Maximum Voltage and Current

Drain-Source Voltage (VDSS) 150 V

Gate-Source Voltage (VGS) -8 to +0 V

Maximum Temperatures

Storage Temperature (TSTG) -55 to +125° C

Operating Junction Temperature +200 °C

ELECTRICAL CHARACTERISTICS @ 25°C

Symbol	Characteristics	Test Conditions	Min	Typ	Max	Units
Pout	Output Power	Pin=0.32W, Freq=1200,1300,1400 MHz	15	19		W
Gp	Power Gain	Pin=0.32W, Freq=1200,1300,1400 MHz	16.7	17.8		dB
ηd	Drain Efficiency	Pin=0.32W, Freq=1200,1300,1400 MHz	50	68		%
Dr	Droop	Pin=0.32W, Freq=1200,1300,1400 MHz		0.2	0.6	dB
VSWR-T	Load Mismatch Tolerance	Pin=0.32W, Freq=1300MHz, 100μ-10%			10:1	

- Bias Condition: Vdd=+50V, Idq=10mA constant current (Vgs= -2.0 ~ -4.5V typical)

FUNCTIONAL CHARACTERISTICS @ 25°C

Id(off)	Drain leakage current	VGS = -8V, VD = 50V			1.0	mA
Ig(off)	Gate leakage current	VGS = -8V, VD = 0V			0.2	mA
BVDSS	Drain-source breakdown voltage	VGS = -8V, ID = 2mA	150			V

Export Classification: EAR-99

For the most current data, consult MICROSEMI's website: www.MICROSEMI.com
Specifications are subject to change, consult the RFIS factory at (408) 986-8031 for the latest information.



1214GN-15E

15 Watts • 50 Volts • 4.5mS, 35%
1200–1400MHz

TYPICAL BROAD BAND PERFORMANCE DATA

Frequency	Pin (mW)	Pout (W)	Id (mA)	RL (dB)	Nd (%)	G (dB)	Drop (dB)
1200 MHz	320	18.5	.210	-7.5	65	17.7	0.2
1300 MHz	320	20.0	.210	-8.0	70	18.0	0.2
1400 MHz	320	19.7	.210	-7.5	69	17.9	0.2

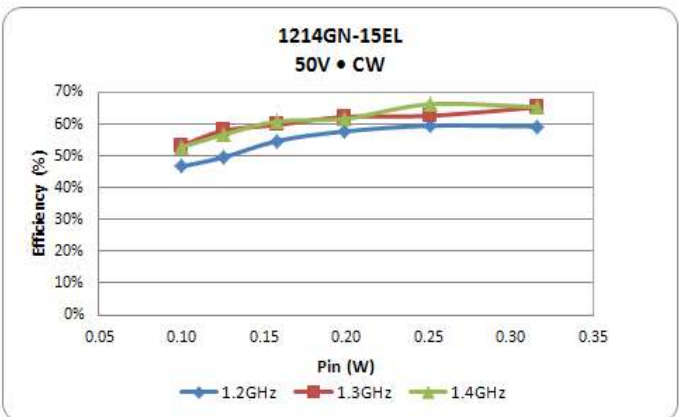
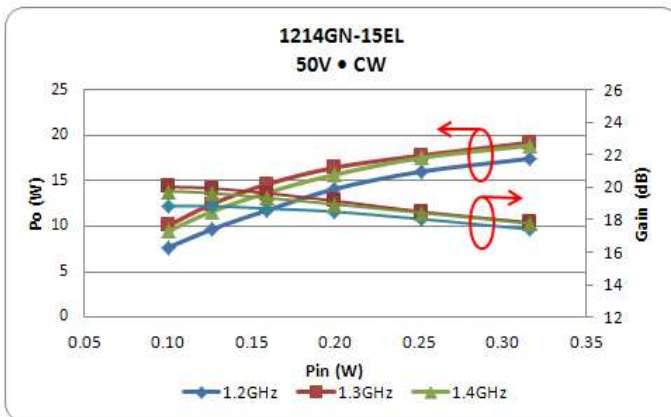
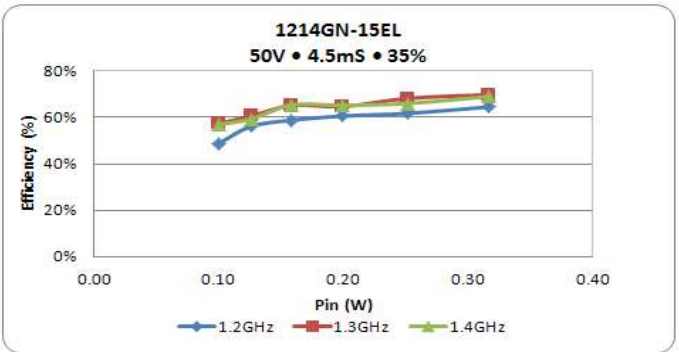
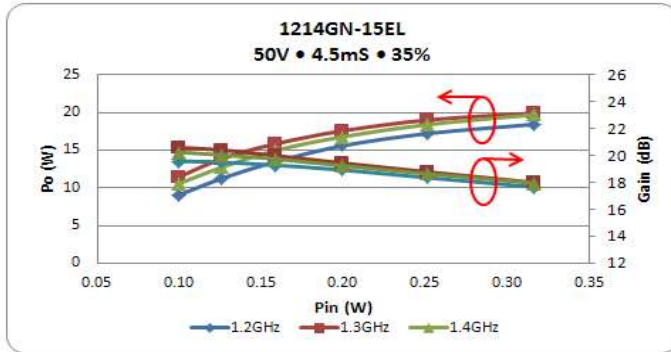
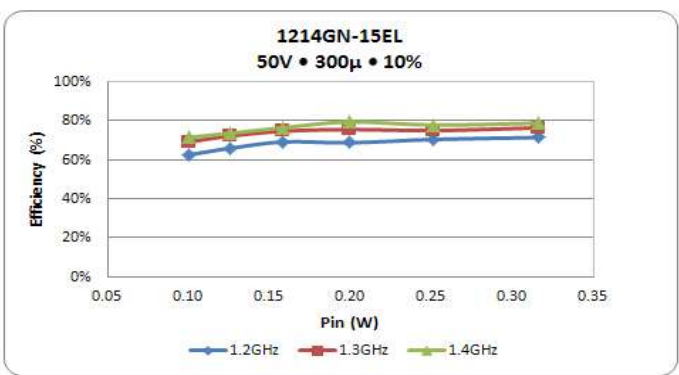
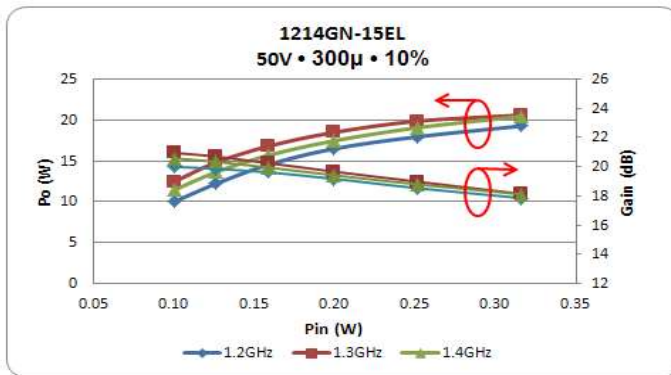

For the most current data, consult MICROSEMI's website: www.MICROSEMI.com
Specifications are subject to change, consult the RFIS factory at (408) 986-8031 for the latest information.



1214GN-15E

15 Watts • 50 Volts • 4.5mS, 35%
1200–1400MHz

Critical Performance @ Pin = 25dBm

Freq (GHz)	Test Condition	Po (W)	Gain (dB)	Eff (%)	Droop (dB)
1.2	300 μ S – 10%	19.3	17.9	70	0.1
1.3	4.5mS – 35%	18.5	17.7	65	0.2
1.4	CW	17.5	17.4	58	0.0
1.2	300 μ S – 10%	20.6	18.2	75	0.1
1.3	4.5mS – 35%	20.0	18.0	70	0.2
1.4	CW	19.2	17.8	65	0.0
1.2	300 μ S – 10%	20.5	18.1	76	0.1
1.3	4.5mS – 35%	19.7	18.0	69	0.2
1.4	CW	18.9	17.8	65	0.0

Test Fixture Overall Dimension

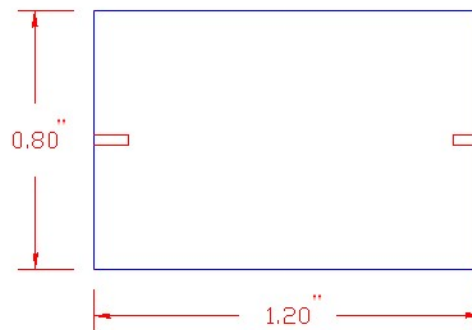

(Dimensions shown are in inches)

Test Fixture available upon request



1214GN-15E

15 Watts • 50 Volts • 4.5mS, 35%
1200–1400MHz

1214GN-15E CASE OUTLINE 55-QQ PACKAGE DIMENSION

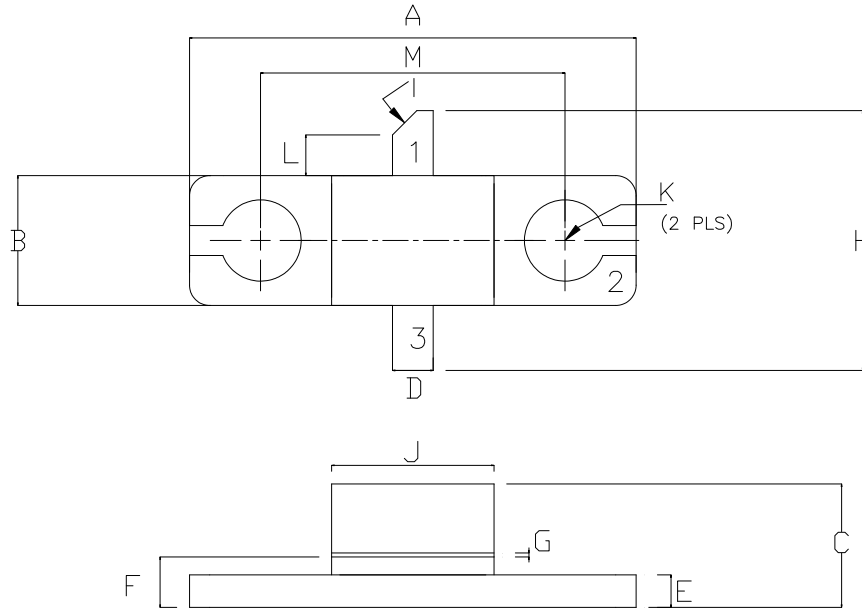

Dim	Millimeter	Tol	Inches	Tol
A	13.970	0.250	0.550	0.010
B	4.570	0.250	0.160	0.010
C	3.860	0.330	0.152	0.013
D	1.270	0.130	0.050	0.005
E	1.020	0.130	0.040	0.005
F	1.700	0.130	0.067	0.005
G	0.130	0.025	0.005	0.001
H	8.130	0.250	0.320	0.010
I	45°	5°	45°	5°
J	5.080	0.250	0.200	0.010
K	2.54 DIA	0.130	.100 DIA	0.005
L	1.270	0.130	0.050	0.005
M	9.530	0.130	0.375	0.005

PIN 1: DRAIN
PIN 2: SOURCE
PIN 3: GATE





1214GN-15E

15 Watts • 50 Volts • 4.5mS, 35%

1200–1400MHz

The information contained in the document is PROPRIETARY AND CONFIDENTIAL information of Microsemi and cannot be copied, published, uploaded, posted, transmitted, distributed or disclosed or used without the express duly signed written consent of Microsemi. If the recipient of this document has entered into a disclosure agreement with Microsemi, then the terms of such Agreement will also apply. This document and the information contained herein may not be modified, by any person other than authorized personnel of Microsemi. No license under any patent, copyright, trade secret or other intellectual property right is granted to or conferred upon you by disclosure or delivery of the information, either expressly, by implication, inducement, estoppel or otherwise. Any license under such intellectual property rights must be approved by Microsemi in writing signed by an officer of Microsemi.

Microsemi reserves the right to change the configuration, functionality and performance of its products at anytime without any notice. This product has been subject to limited testing and should not be used in conjunction with life-support or other mission-critical equipment or applications. Microsemi assumes no liability whatsoever, and Microsemi disclaims any express or implied warranty, relating to sale and/or use of Microsemi products including liability or warranties relating to fitness for a particular purpose, merchantability, or infringement of any patent, copyright or other intellectual property right. The product is subject to other terms and conditions which can be located on the Web at <http://www.microsemi.com/legal/tnc.asp>.

Revision History

Revision Level / Date	Para. Affected	Description
0.2 / 04 Dec. 2014	-	Initial Preliminary Release

For the most current data, consult MICROSEMI's website: www.MICROSEMI.com
Specifications are subject to change, consult the RFIS factory at (408) 986-8031 for the latest information.