

## DATASHEET

# UJ4C075023K3S

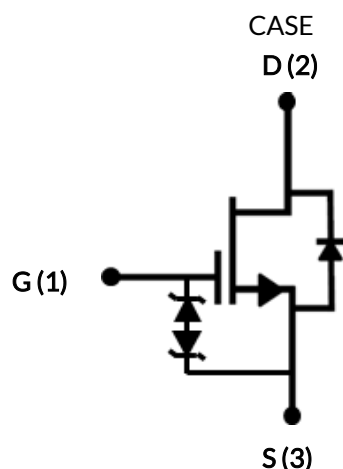

## 750V-23mΩ SiC FET

Rev. B, July 2021

### Description

The UJ4C075023K3S is a 750V, 23mΩ G4 SiC FET. It is based on a unique ‘cascode’ circuit configuration, in which a normally-on SiC JFET is co-packaged with a Si MOSFET to produce a normally-off SiC FET device. The device’s standard gate-drive characteristics allows for a true “drop-in replacement” to Si IGBTs, Si FETs, SiC MOSFETs or Si superjunction devices. Available in the TO-247-3L package, this device exhibits ultra-low gate charge and exceptional reverse recovery characteristics, making it ideal for switching inductive loads and any application requiring standard gate drive.

### Features

- ◆ On-resistance  $R_{DS(on)}$ : 23mΩ (typ)
- ◆ Operating temperature: 175°C (max)
- ◆ Excellent reverse recovery:  $Q_{rr}$  = 84nC
- ◆ Low body diode  $V_{FSD}$ : 1.23V
- ◆ Low gate charge:  $Q_G$  = 37.8nC
- ◆ Threshold voltage  $V_{G(th)}$ : 4.8V (typ) allowing 0 to 15V drive
- ◆ Low intrinsic capacitance
- ◆ ESD protected: HBM class 2 and CDM class C3

Part Number	Package	Marking
UJ4C075023K3S	TO-247-3L	UJ4C075023K3S



### Typical applications

- ◆ EV charging
- ◆ PV inverters
- ◆ Switch mode power supplies
- ◆ Power factor correction modules
- ◆ Motor drives
- ◆ Induction heating

## Maximum Ratings

Parameter	Symbol	Test Conditions	Value	Units
Drain-source voltage	$V_{DS}$		750	V
Gate-source voltage	$V_{GS}$	DC	-20 to +20	V
		AC (f > 1Hz)	-25 to +25	V
Continuous drain current <sup>1</sup>	$I_D$	$T_C = 25^\circ\text{C}$	66	A
		$T_C = 100^\circ\text{C}$	49	A
Pulsed drain current <sup>2</sup>	$I_{DM}$	$T_C = 25^\circ\text{C}$	196	A
Single pulsed avalanche energy <sup>3</sup>	$E_{AS}$	L=15mH, $I_{AS} = 3\text{A}$	67	mJ
SiC FET dv/dt ruggedness	dv/dt	$V_{DS} \leq 500\text{V}$	150	V/ns
Power dissipation	$P_{tot}$	$T_C = 25^\circ\text{C}$	306	W
Maximum junction temperature	$T_{J,max}$		175	$^\circ\text{C}$
Operating and storage temperature	$T_J, T_{STG}$		-55 to 175	$^\circ\text{C}$
Max. lead temperature for soldering, 1/8" from case for 5 seconds	$T_L$		250	$^\circ\text{C}$

1. Limited by  $T_{J,max}$

2. Pulse width  $t_p$  limited by  $T_{J,max}$

3. Starting  $T_J = 25^\circ\text{C}$

## Thermal Characteristics

Parameter	Symbol	Test Conditions	Value			Units
			Min	Typ	Max	
Thermal resistance, junction-to-case	$R_{\theta JC}$			0.38	0.49	$^\circ\text{C/W}$

## Electrical Characteristics ( $T_J = +25^\circ\text{C}$ unless otherwise specified)

### Typical Performance - Static

Parameter	Symbol	Test Conditions	Value			Units
			Min	Typ	Max	
Drain-source breakdown voltage	$BV_{DS}$	$V_{GS}=0V, I_D=1mA$	750			V
Total drain leakage current	$I_{DSS}$	$V_{DS}=750V, V_{GS}=0V, T_J=25^\circ\text{C}$		2	30	$\mu\text{A}$
		$V_{DS}=750V, V_{GS}=0V, T_J=175^\circ\text{C}$		15		
Total gate leakage current	$I_{GSS}$	$V_{DS}=0V, T_J=25^\circ\text{C}, V_{GS}=-20V / +20V$		6	$\pm 20$	$\mu\text{A}$
Drain-source on-resistance	$R_{DS(on)}$	$V_{GS}=12V, I_D=40A, T_J=25^\circ\text{C}$		23	29	m $\Omega$
		$V_{GS}=12V, I_D=40A, T_J=125^\circ\text{C}$		39		
		$V_{GS}=12V, I_D=40A, T_J=175^\circ\text{C}$		50		
Gate threshold voltage	$V_{G(th)}$	$V_{DS}=5V, I_D=10mA$	4	4.8	6	V
Gate resistance	$R_G$	f=1MHz, open drain		4.5		$\Omega$

### Typical Performance - Reverse Diode

Parameter	Symbol	Test Conditions	Value			Units
			Min	Typ	Max	
Diode continuous forward current <sup>1</sup>	$I_S$	$T_C = 25^\circ\text{C}$			66	A
Diode pulse current <sup>2</sup>	$I_{S,pulse}$	$T_C = 25^\circ\text{C}$			196	A
Forward voltage	$V_{FSD}$	$V_{GS}=0V, I_S=20A, T_J=25^\circ\text{C}$		1.23	1.39	V
		$V_{GS}=0V, I_S=20A, T_J=175^\circ\text{C}$		1.45		
Reverse recovery charge	$Q_{rr}$	$V_R=400V, I_S=40A, V_{GS}=0V, R_{G,EXT}=5\Omega$		84		nC
Reverse recovery time	$t_{rr}$	di/dt=1500A/ $\mu\text{s}, T_J=25^\circ\text{C}$		27		ns
Reverse recovery charge	$Q_{rr}$	$V_R=400V, I_S=40A, V_{GS}=0V, R_{G,EXT}=5\Omega$		91		nC
Reverse recovery time	$t_{rr}$	di/dt=1500A/ $\mu\text{s}, T_J=150^\circ\text{C}$		28		ns

## Typical Performance - Dynamic

Parameter	Symbol	Test Conditions	Value			Units
			Min	Typ	Max	
Input capacitance	$C_{iss}$	$V_{DS}=400V, V_{GS}=0V$ $f=100kHz$		1400		pF
Output capacitance	$C_{oss}$			93		
Reverse transfer capacitance	$C_{rss}$			2.5		
Effective output capacitance, energy related	$C_{oss(er)}$	$V_{DS}=0V$ to 400V, $V_{GS}=0V$		116		pF
Effective output capacitance, time related	$C_{oss(tr)}$	$V_{DS}=0V$ to 400V, $V_{GS}=0V$		232		pF
$C_{oss}$ stored energy	$E_{oss}$	$V_{DS}=400V, V_{GS}=0V$		9.3		$\mu J$
Total gate charge	$Q_G$	$V_{DS}=400V, I_D=40A,$ $V_{GS} = 0V$ to 15V		37.8		nC
Gate-drain charge	$Q_{GD}$			8		
Gate-source charge	$Q_{GS}$			11.8		
Turn-on delay time	$t_{d(on)}$	Notes 4 and 5, $V_{DS}=400V, I_D=40A,$ Gate Driver =0V to +15V, Turn-on $R_{G,EXT}=1\Omega,$ Turn-off $R_{G,EXT}=5\Omega,$ inductive Load, FWD: same device with $V_{GS} = 0V$ and $R_G = 5\Omega,$ RC snubber: $R_S=10\Omega$ and $C_S=200pF,$ $T_J=25^\circ C$		10		ns
Rise time	$t_r$			49		
Turn-off delay time	$t_{d(off)}$			53		
Fall time	$t_f$			14		
Turn-on energy including $R_S$ energy	$E_{ON}$			455		
Turn-off energy including $R_S$ energy	$E_{OFF}$			140		
Total switching energy	$E_{TOTAL}$	Notes 4 and 5, $V_{DS}=400V, I_D=40A,$ Gate Driver =0V to +15V, Turn-on $R_{G,EXT}=1\Omega,$ Turn-off $R_{G,EXT}=5\Omega,$ inductive Load, FWD: same device with $V_{GS} = 0V$ and $R_G = 5\Omega,$ RC snubber: $R_S=10\Omega$ and $C_S=200pF,$ $T_J=150^\circ C$		595		$\mu J$
Snubber $R_S$ energy during turn-on	$E_{RS\_ON}$			4		
Snubber $R_S$ energy during turn-off	$E_{RS\_OFF}$			10		
Turn-on delay time	$t_{d(on)}$			15		
Rise time	$t_r$			47		
Turn-off delay time	$t_{d(off)}$			51		
Fall time	$t_f$	Notes 4 and 5, $V_{DS}=400V, I_D=40A,$ Gate Driver =0V to +15V, Turn-on $R_{G,EXT}=1\Omega,$ Turn-off $R_{G,EXT}=5\Omega,$ inductive Load, FWD: same device with $V_{GS} = 0V$ and $R_G = 5\Omega,$ RC snubber: $R_S=10\Omega$ and $C_S=200pF,$ $T_J=150^\circ C$		14		ns
Turn-on energy including $R_S$ energy	$E_{ON}$			505		
Turn-off energy including $R_S$ energy	$E_{OFF}$			157		
Total switching energy	$E_{TOTAL}$			662		
Snubber $R_S$ energy during turn-on	$E_{RS\_ON}$			4		
Snubber $R_S$ energy during turn-off	$E_{RS\_OFF}$			10		

4. Measured with the switching test circuit in Figure 35.

5. In this datasheet, all the switching energies (turn-on energy, turn-off energy and total energy) presented in the tables and Figures include the device RC snubber energy losses.

## Typical Performance - Dynamic (continued)

Parameter	Symbol	Test Conditions	Value			Units	
			Min	Typ	Max		
Turn-on delay time	$t_{d(on)}$	Note 6, $V_{DS}=400V$ , $I_D=40A$ , Gate Driver =0V to +15V, Turn-on $R_{G,EXT}=1\Omega$ , Turn-off $R_{G,EXT}=5\Omega$ , inductive Load, FWD: UJ3D06520TS, RC snubber: $R_S=10\Omega$ and $C_S=200pF$ , $T_J=25^\circ C$		10		ns	
Rise time	$t_r$			45			
Turn-off delay time	$t_{d(off)}$			50			
Fall time	$t_f$			11			
Turn-on energy including $R_S$ energy	$E_{ON}$				366		$\mu J$
Turn-off energy including $R_S$ energy	$E_{OFF}$				135		
Total switching energy	$E_{TOTAL}$				501		
Snubber $R_S$ energy during turn-on	$E_{RS\_ON}$				4.4		
Snubber $R_S$ energy during turn-off	$E_{RS\_OFF}$				10		
Turn-on delay time	$t_{d(on)}$	Note 6, $V_{DS}=400V$ , $I_D=40A$ , Gate Driver =0V to +15V, Turn-on $R_{G,EXT}=1\Omega$ , Turn-off $R_{G,EXT}=5\Omega$ , inductive Load, FWD: UJ3D06520TS, RC snubber: $R_S=10\Omega$ and $C_S=200pF$ , $T_J=150^\circ C$		10		ns	
Rise time	$t_r$			47			
Turn-off delay time	$t_{d(off)}$			53			
Fall time	$t_f$			17			
Turn-on energy including $R_S$ energy	$E_{ON}$				450		$\mu J$
Turn-off energy including $R_S$ energy	$E_{OFF}$				157		
Total switching energy	$E_{TOTAL}$				607		
Snubber $R_S$ energy during turn-on	$E_{RS\_ON}$				4.4		
Snubber $R_S$ energy during turn-off	$E_{RS\_OFF}$				10		

6. Measured with the switching test circuit in Figure 36.

### Typical Performance Diagrams

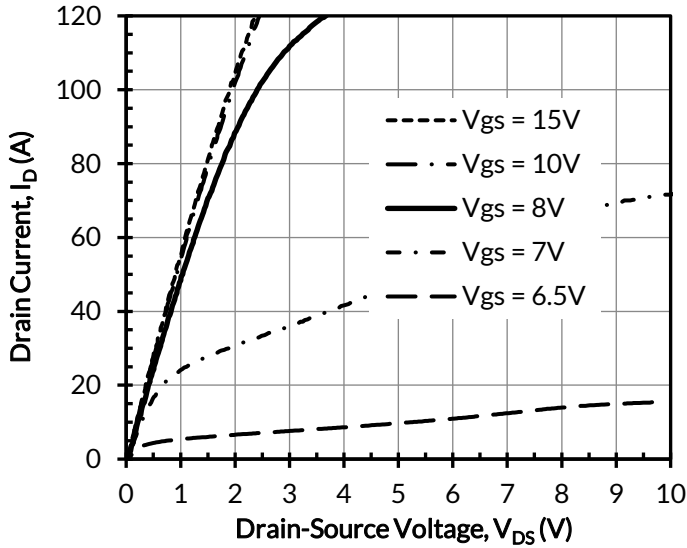

Figure 1. Typical output characteristics at  $T_j = -55^\circ\text{C}$ ,  $t_p < 250\mu\text{s}$

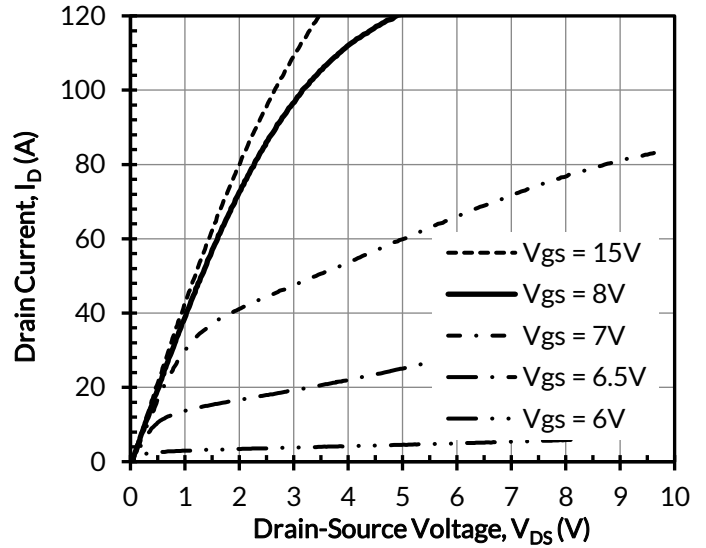

Figure 2. Typical output characteristics at  $T_j = 25^\circ\text{C}$ ,  $t_p < 250\mu\text{s}$

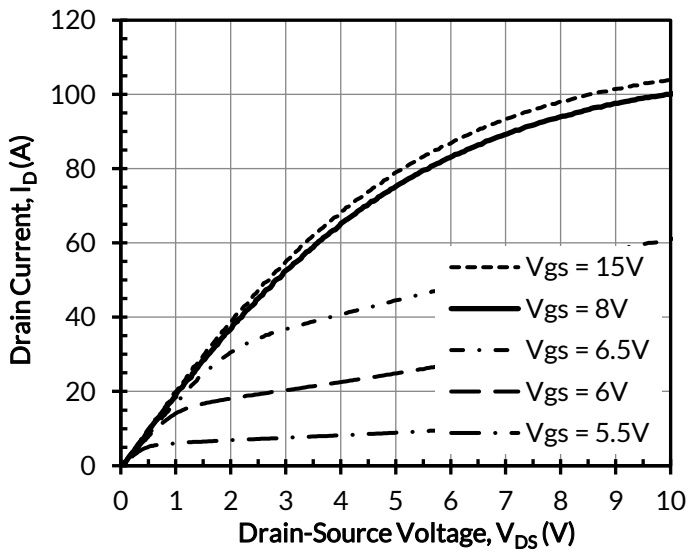

Figure 3. Typical output characteristics at  $T_j = 175^\circ\text{C}$ ,  $t_p < 250\mu\text{s}$

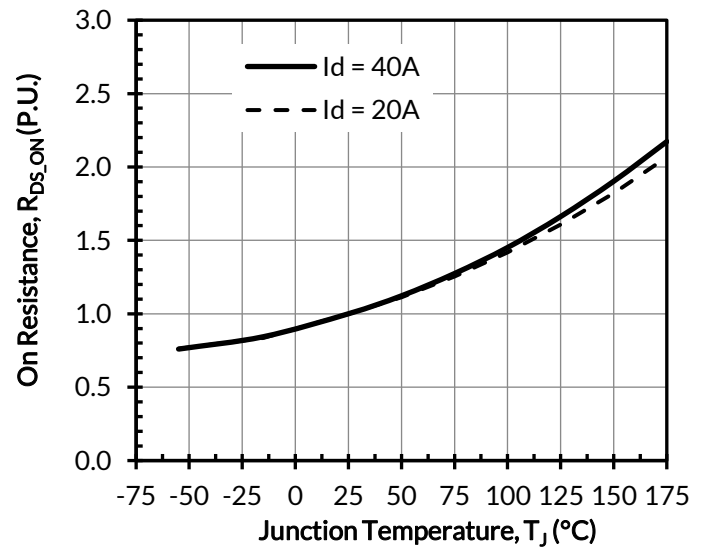

Figure 4. Normalized on-resistance vs. temperature at  $V_{GS} = 12\text{V}$

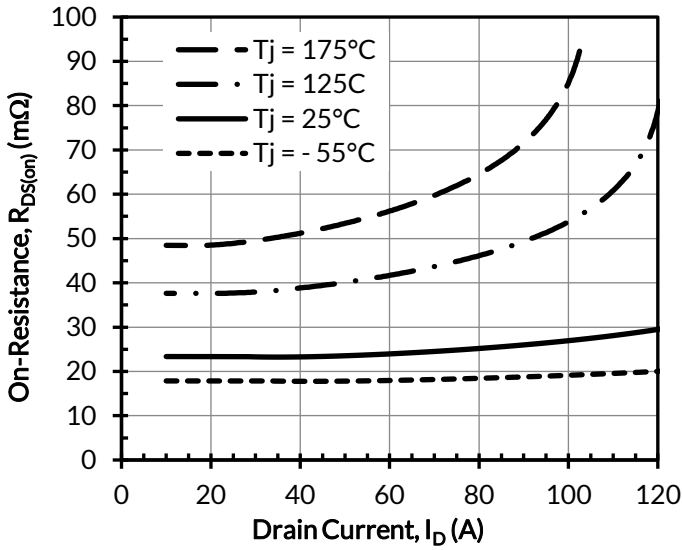

Figure 5. Typical drain-source on-resistances at  $V_{GS} = 12V$

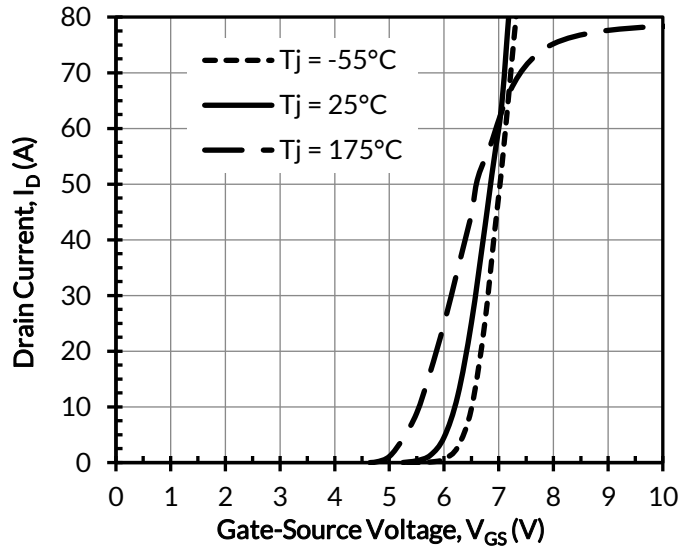

Figure 6. Typical transfer characteristics at  $V_{DS} = 5V$

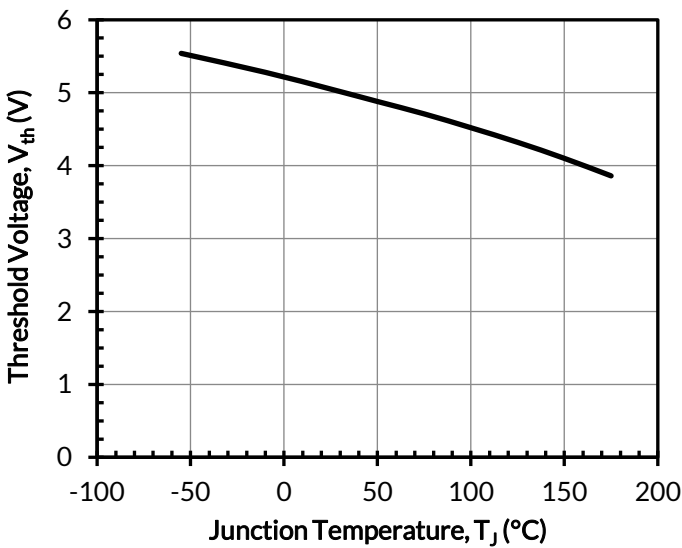

Figure 7. Threshold voltage vs. junction temperature at  $V_{DS} = 5V$  and  $I_D = 10mA$

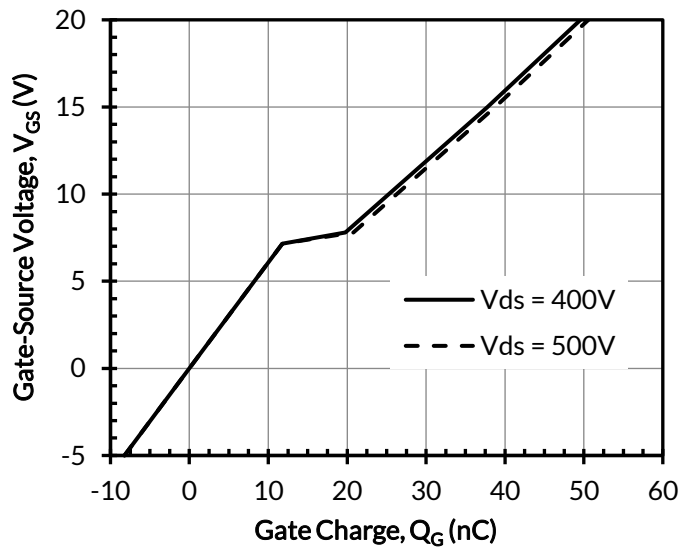

Figure 8. Typical gate charge at  $I_D = 40A$

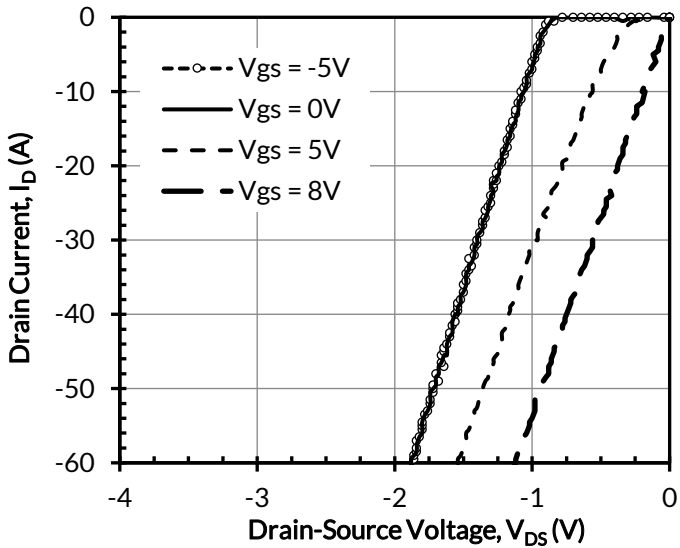

Figure 9. 3rd quadrant characteristics at  $T_J = -55^\circ\text{C}$

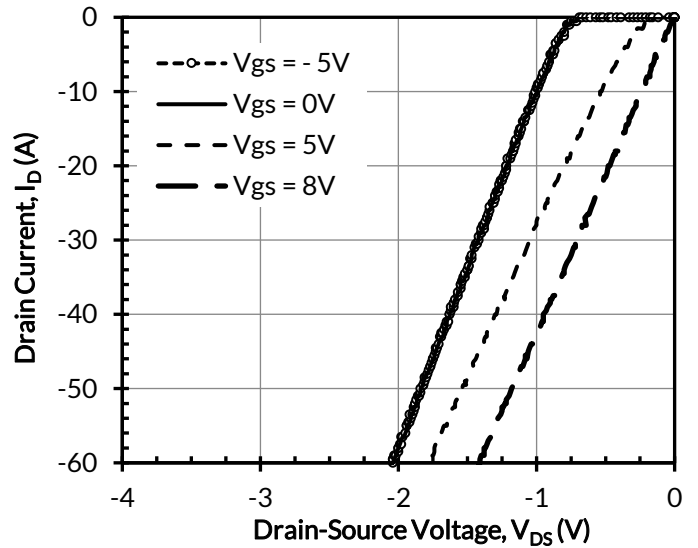

Figure 10. 3rd quadrant characteristics at  $T_J = 25^\circ\text{C}$

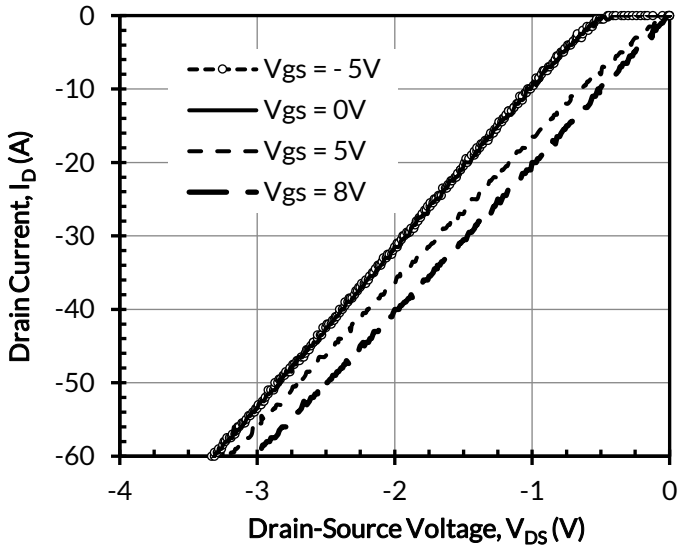

Figure 11. 3rd quadrant characteristics at  $T_J = 175^\circ\text{C}$

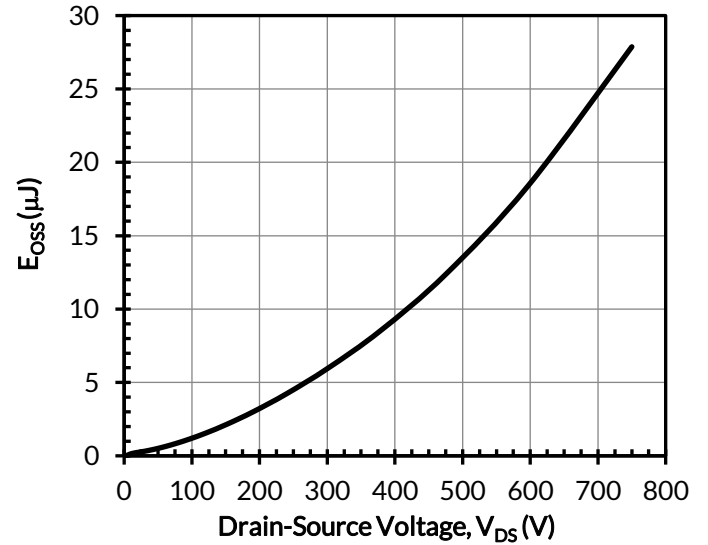

Figure 12. Typical stored energy in  $C_{OSS}$  at  $V_{GS} = 0\text{V}$



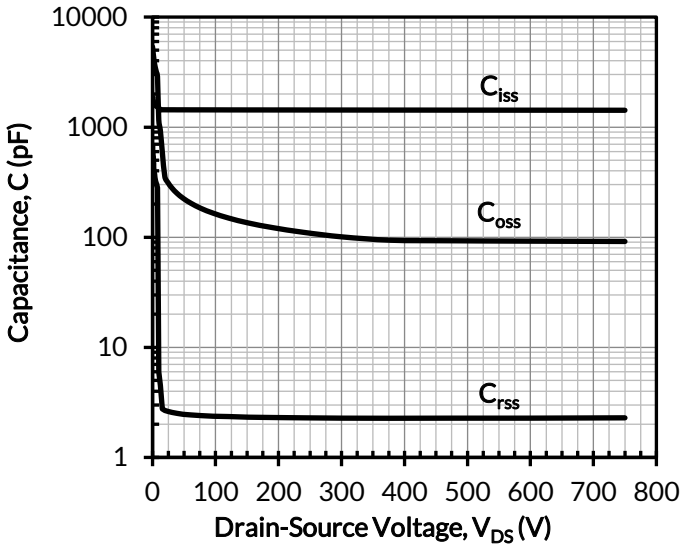

Figure 13. Typical capacitances at  $f = 100\text{kHz}$  and  $V_{GS} = 0\text{V}$

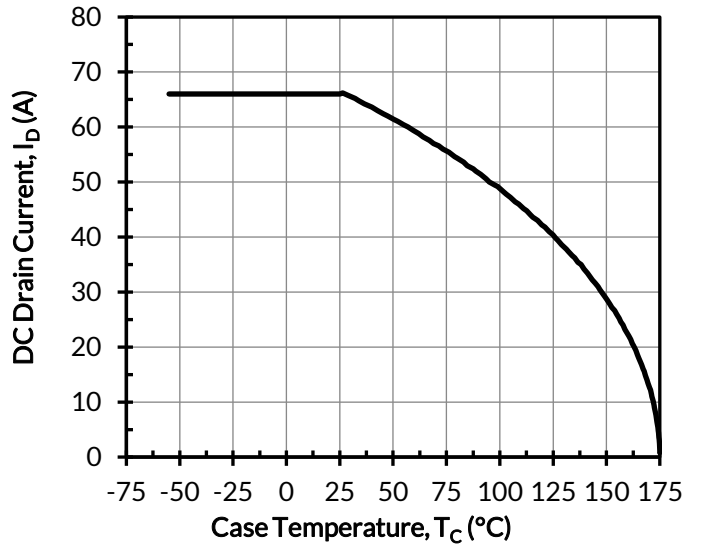

Figure 14. DC drain current derating

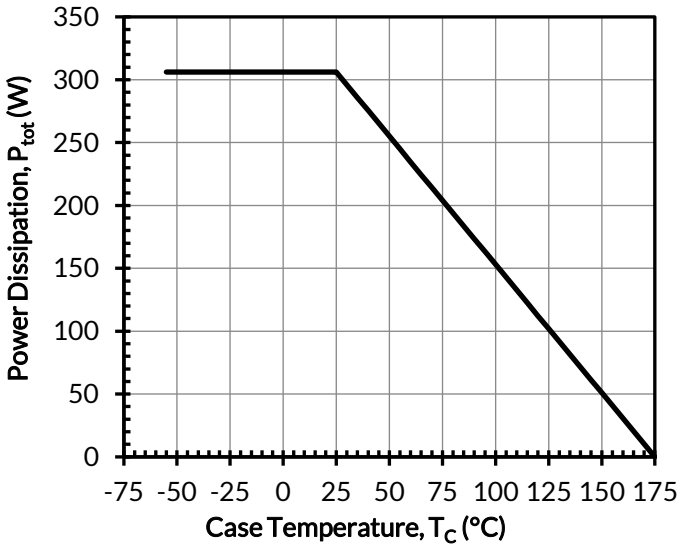

Figure 15. Total power dissipation

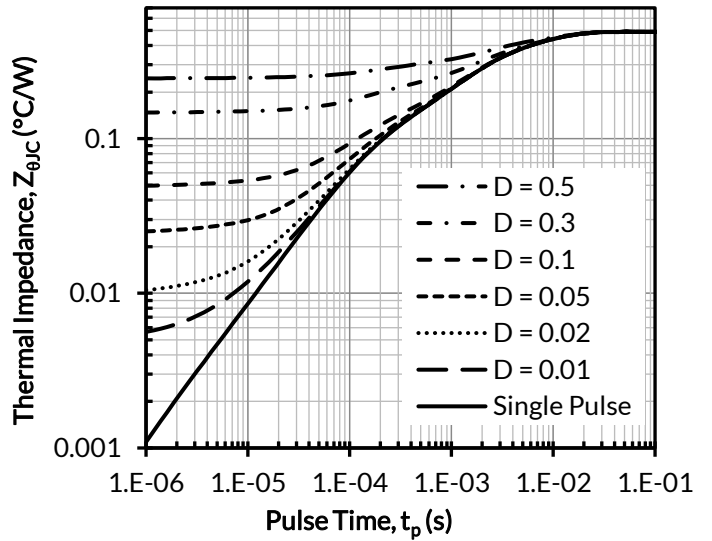

Figure 16. Maximum transient thermal impedance

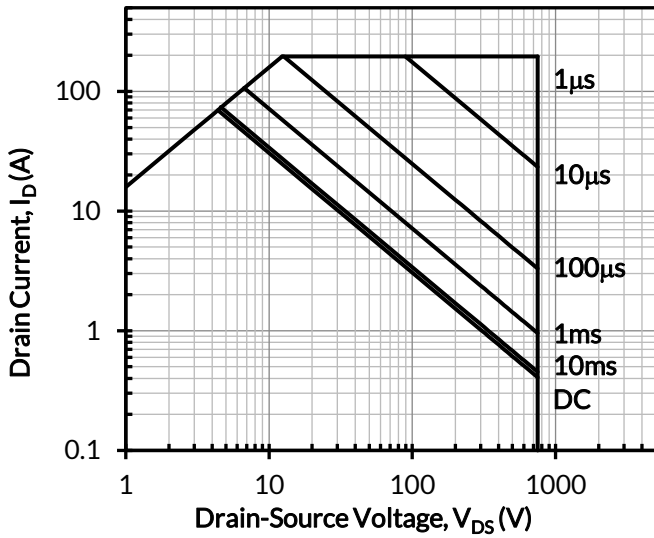

Figure 17. Safe operation area at  $T_C = 25^\circ\text{C}$ ,  $D = 0$ , Parameter  $t_p$

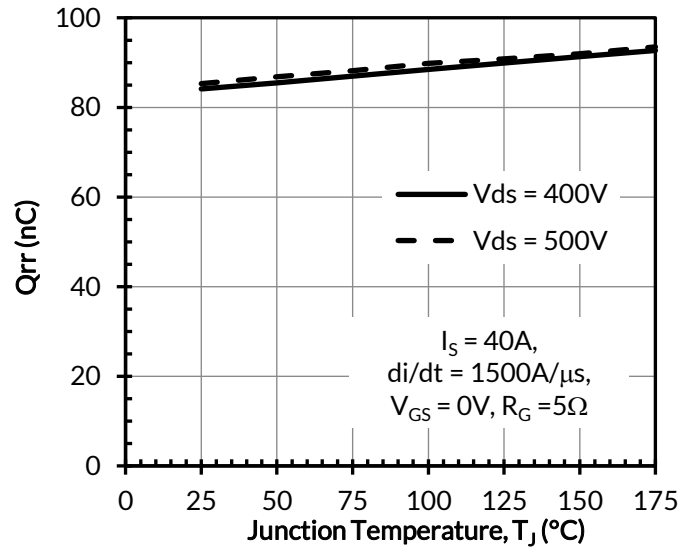

Figure 18. Reverse recovery charge  $Q_{rr}$  vs. junction temperature

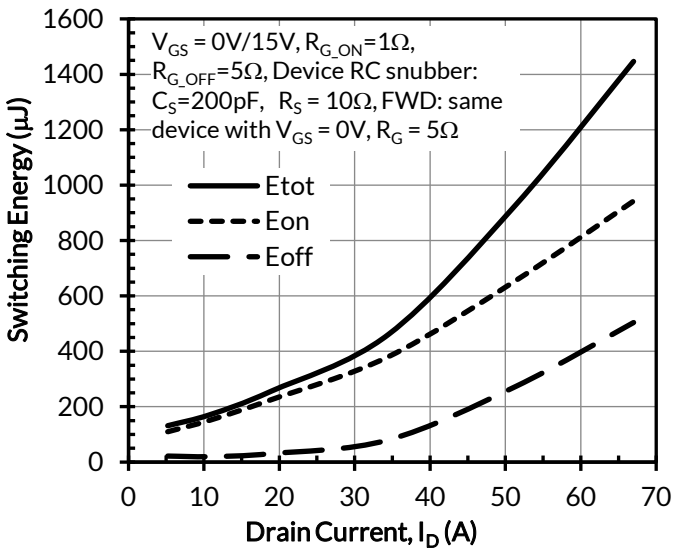

Figure 19. Clamped inductive switching energy vs. drain current at  $V_{DS} = 400\text{V}$  and  $T_J = 25^\circ\text{C}$

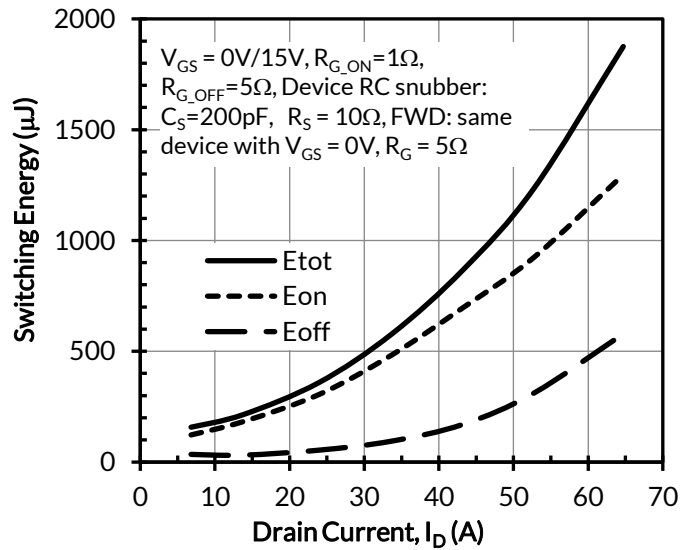

Figure 20. Clamped inductive switching energy vs. drain current at  $V_{DS} = 500\text{V}$  and  $T_J = 25^\circ\text{C}$

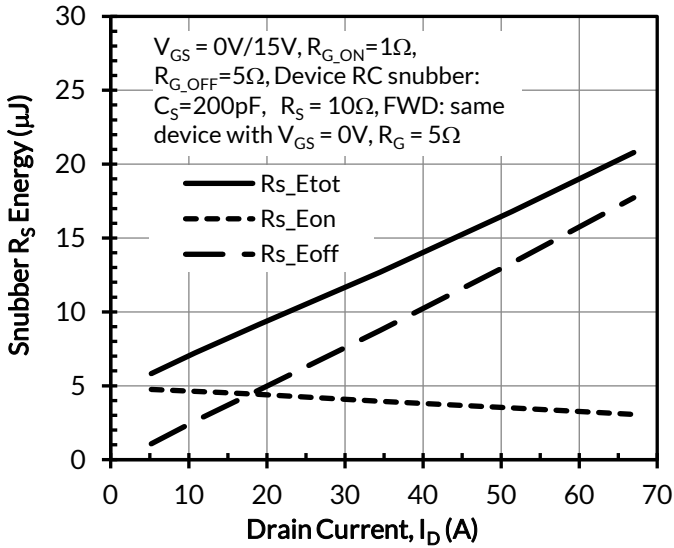

Figure 21. RC snubber energy loss vs. drain current at  $V_{DS} = 400V$  and  $T_J = 25^\circ C$

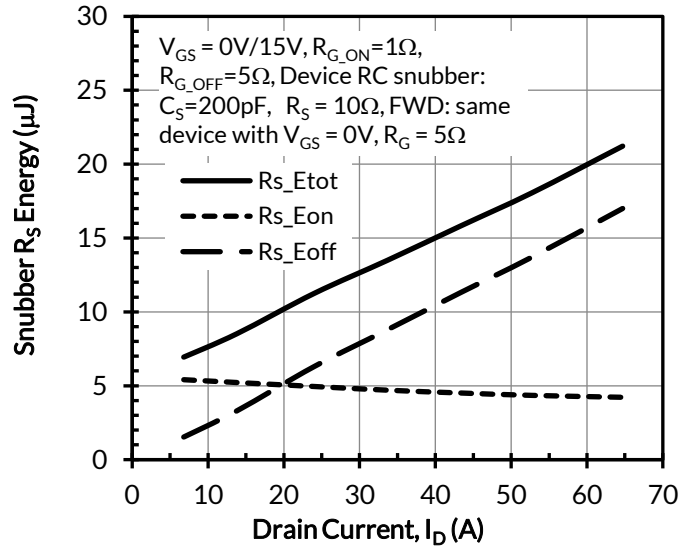

Figure 22. RC snubber energy losses vs. drain current at  $V_{DS} = 500V$  and  $T_J = 25^\circ C$

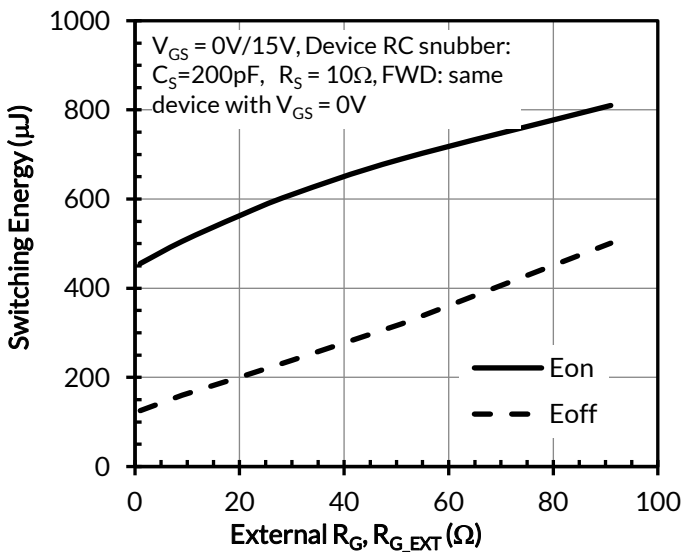

Figure 23. Clamped inductive switching energies vs.  $R_{G\_EXT}$  at  $V_{DS} = 400V, I_D = 40A,$  and  $T_J = 25^\circ C$

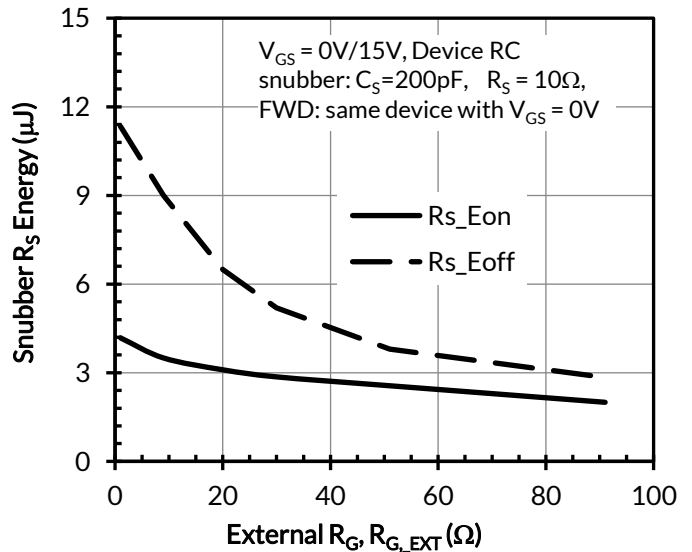

Figure 24. RC snubber energy losses vs.  $R_{G\_EXT}$  at  $V_{DS} = 400V, I_D = 40A,$  and  $T_J = 25^\circ C$

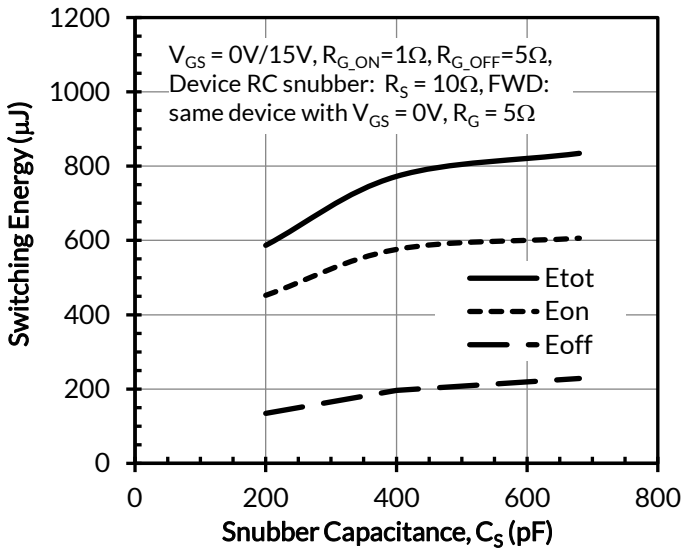

Figure 25. Clamped inductive switching energies vs. snubber capacitance  $C_S$  at  $V_{DS} = 400V$ ,  $I_D = 40A$ , and  $T_J = 25^\circ C$

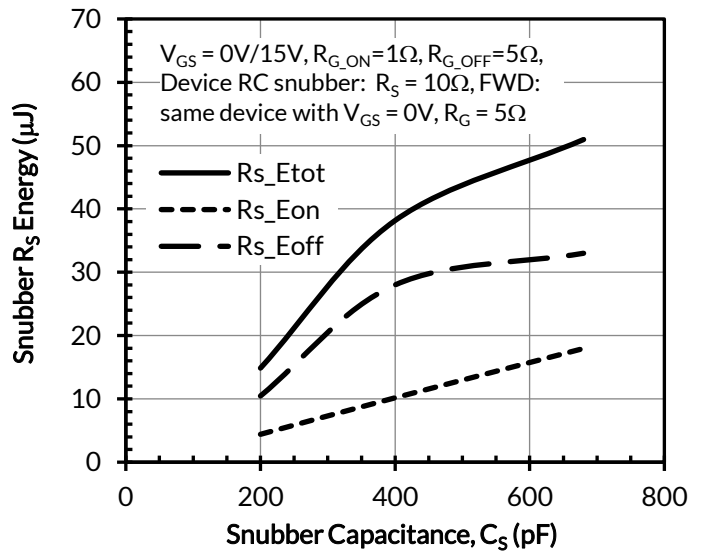

Figure 26. RC snubber energy losses vs. snubber capacitance  $C_S$  at  $V_{DS} = 400V$ ,  $I_D = 40A$ , and  $T_J = 25^\circ C$

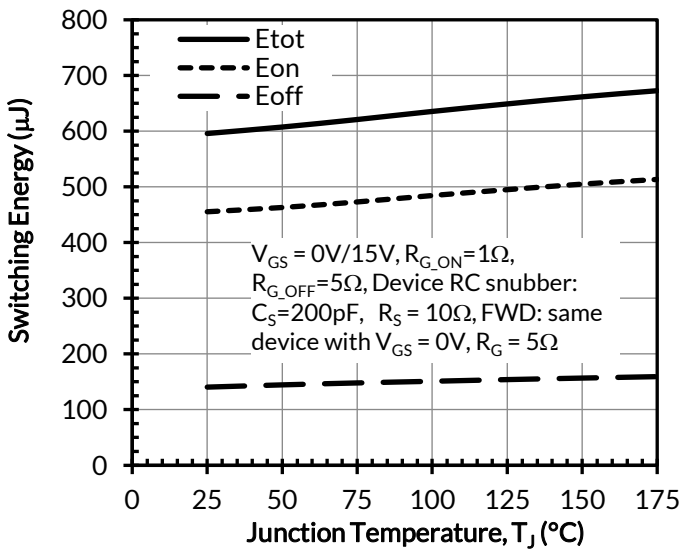

Figure 27. Clamped inductive switching energy vs. junction temperature at  $V_{DS} = 400V$  and  $I_D = 40A$

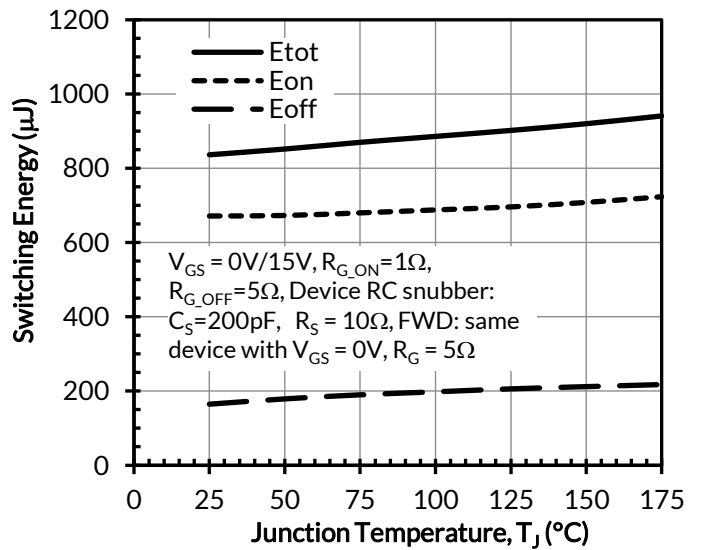

Figure 28. Clamped inductive switching energy vs. junction temperature at  $V_{DS} = 500V$  and  $I_D = 40A$

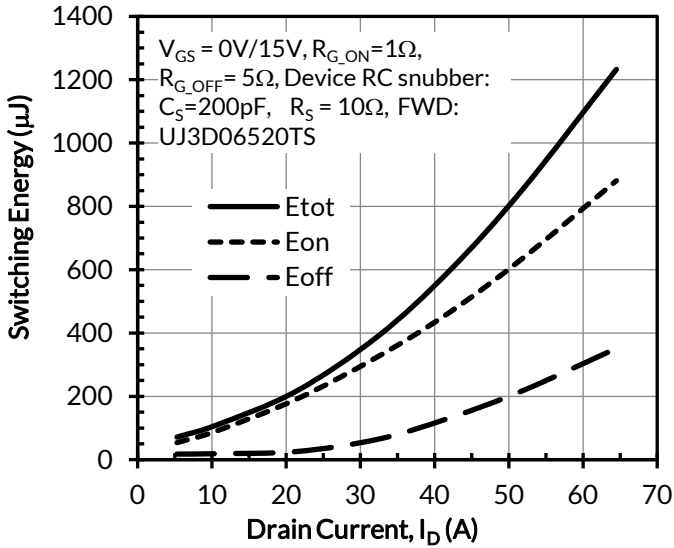

Figure 29. Clamped inductive switching energy vs. drain current at  $V_{DS} = 400V$  and  $T_J = 25^\circ C$

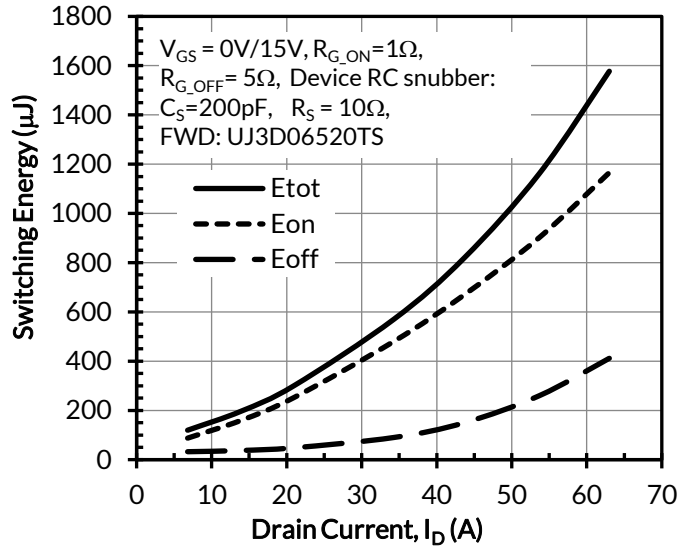

Figure 30. Clamped inductive switching energy vs. drain current at  $V_{DS} = 500V$  and  $T_J = 25^\circ C$

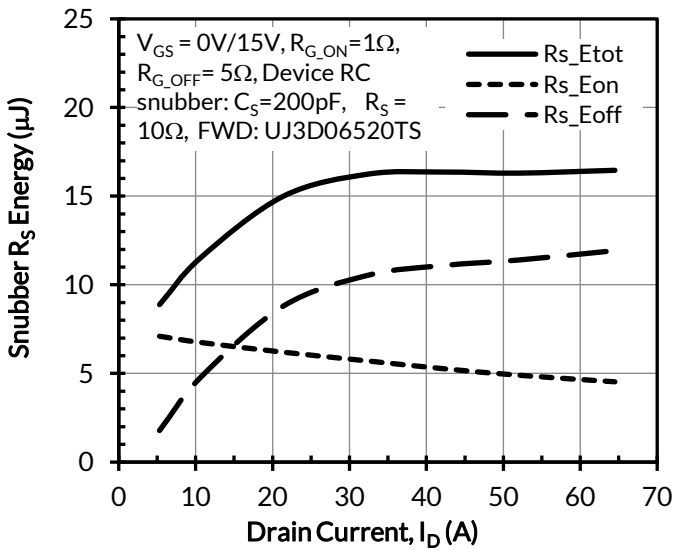

Figure 31. RC snubber energy losses vs. drain current at  $V_{DS} = 400V$  and  $T_J = 25^\circ C$

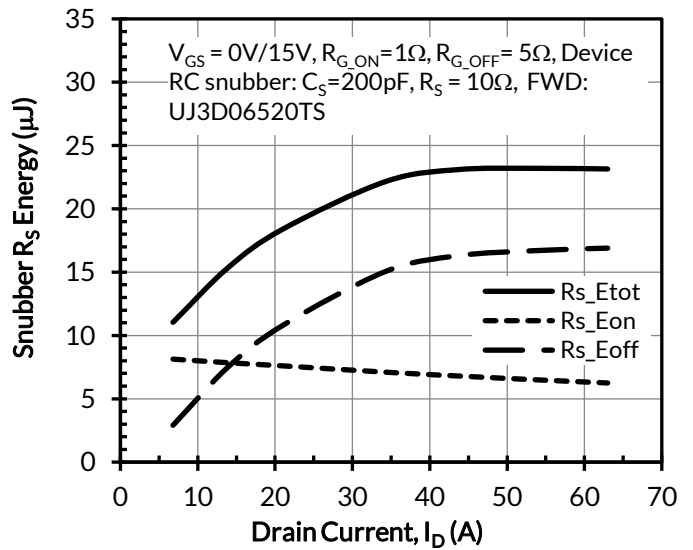

Figure 32. RC snubber energy losses vs. drain current at  $V_{DS} = 500V$  and  $T_J = 25^\circ C$

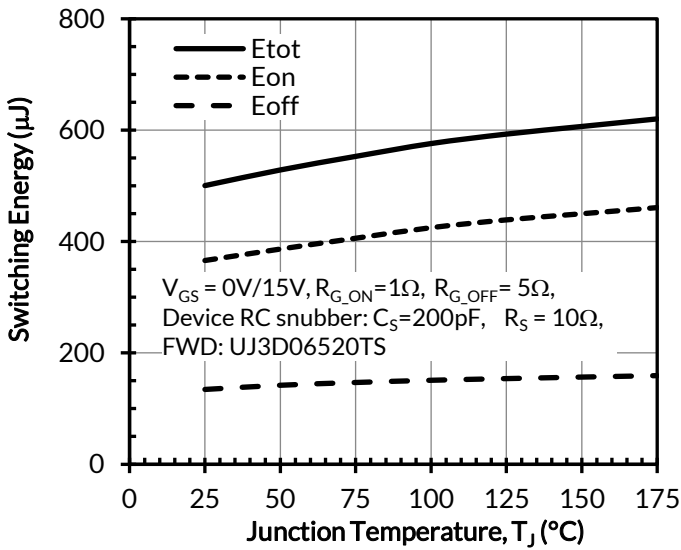

Figure 33. Clamped inductive switching energy vs. junction temperature at  $V_{DS} = 400V$  and  $I_D = 40A$

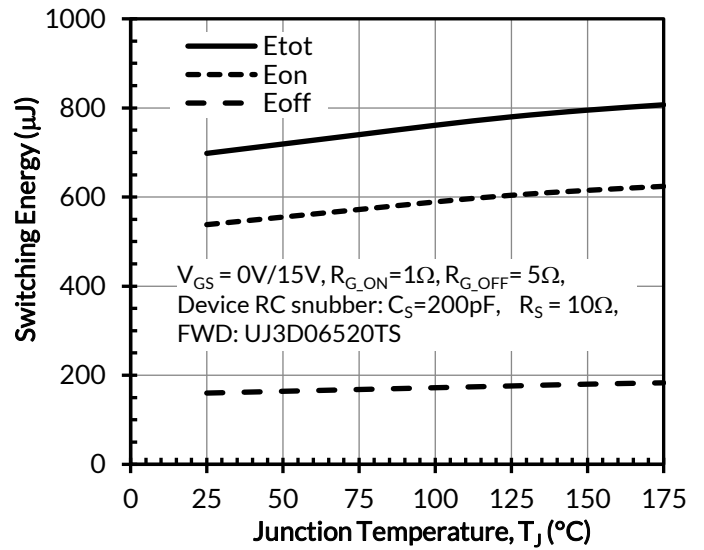

Figure 34. Clamped inductive switching energy vs. junction temperature at  $V_{DS} = 500V$  and  $I_D = 40A$

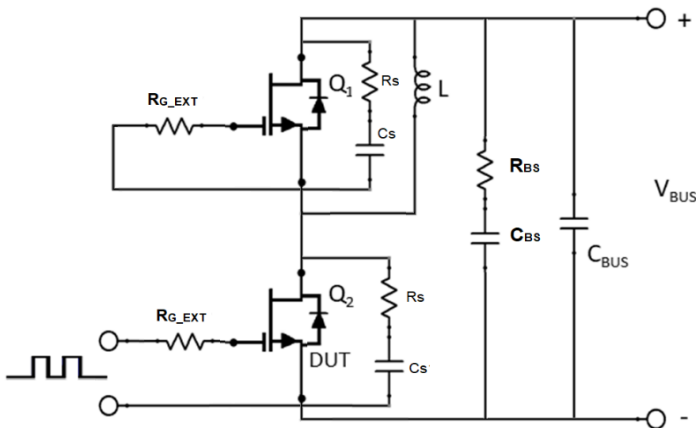

Figure 35. Schematic of the half-bridge mode switching test circuit. Note, a bus RC snubber ( $R_{BS} = 2.5\Omega, C_{BS} = 100nF$ ) is used to reduce the power loop high frequency oscillations.

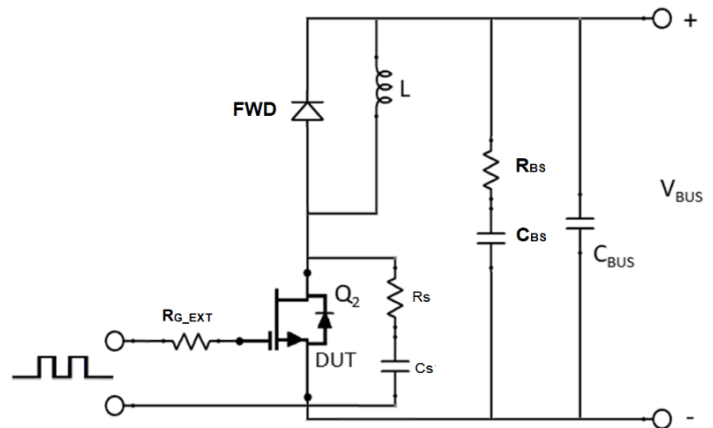

Figure 36. Schematic of the chopper mode switching test circuit. Note, a bus RC snubber ( $R_{BS} = 2.5\Omega, C_{BS} = 100nF$ ) is used to reduce the power loop high frequency oscillations.

## Applications Information

SiC FETs are enhancement-mode power switches formed by a high-voltage SiC depletion-mode JFET and a low-voltage silicon MOSFET connected in series. The silicon MOSFET serves as the control unit while the SiC JFET provides high voltage blocking in the off state. This combination of devices in a single package provides compatibility with standard gate drivers and offers superior performance in terms of low on-resistance ( $R_{DS(on)}$ ), output capacitance ( $C_{oss}$ ), gate charge ( $Q_G$ ), and reverse recovery charge ( $Q_{rr}$ ) leading to low conduction and switching losses. The SiC FETs also provide excellent reverse conduction capability eliminating the need for an external anti-parallel diode.

Like other high performance power switches, proper PCB layout design to minimize circuit parasitics is strongly recommended due to the high  $dv/dt$  and  $di/dt$  rates. An external gate resistor is recommended when the FET is working in the diode mode in order to achieve the optimum reverse recovery performance. For more information on SiC FET operation, see [www.unitedsic.com](http://www.unitedsic.com).

A snubber circuit with a small  $R_{(G)}$ , or gate resistor, provides better EMI suppression with higher efficiency compared to using a high  $R_{(G)}$  value. There is no extra gate delay time when using the snubber circuitry, and a small  $R_{(G)}$  will better control both the turn-off  $V_{(DS)}$  peak spike and ringing duration, while a high  $R_{(G)}$  will damp the peak spike but result in a longer delay time. In addition, the total switching loss when using a snubber circuit is less than using high  $R_{(G)}$ , while greatly reducing  $E_{(OFF)}$  from mid-to-full load range with only a small increase in  $E_{(ON)}$ . Efficiency will therefore improve with higher load current. For more information on how a snubber circuit will improve overall system performance, visit the UnitedSiC website at [www.unitedsic.com](http://www.unitedsic.com)

## Disclaimer

UnitedSiC reserves the right to change or modify any of the products and their inherent physical and technical specifications without prior notice. UnitedSiC assumes no responsibility or liability for any errors or inaccuracies within.

Information on all products and contained herein is intended for description only. No license, express or implied, to any intellectual property rights is granted within this document.

UnitedSiC assumes no liability whatsoever relating to the choice, selection or use of the UnitedSiC products and services described herein.