



TAOGLAS®



Datasheet

Pantheon MA752 5-in-1 Screw Mount Antenna

Part No:
MA752.B.ABICG.001

Description:

Pantheon MA752 5-in-1 Screw Mount Antenna
GPS/GLONASS/Galileo, 5G/4G MIMO, 2.4/5.8Hz MIMO

Features:

- NEW – Addition of LTE 450MHz band!**
- 2 x 5G/4G 450-6000MHz Antennas (MIMO)
- 1 x GPS/GLONASS/Galileo 1575.42/1602MHz Active Antenna
- 2 x Wi-Fi 2.4GHz/5.8GHz Antennas (MIMO)
- IP67 Waterproof
- Front End SAW Filter
- High Efficiency / Peak Gain Outdoor Antenna
- Dimensions: \varnothing 143.2 x 82.4mm
- Fully Customizable Cable and Connectors
- RoHs & Reach Compliant

1. Introduction	3
2. Specifications	4
3. Antenna Characteristics	8
4. Radiation Patterns	16
5. Mechanical Drawing	36
6. Installation	37
7. Packaging	38
<hr/>	
Changelog	39

Taoglas makes no warranties based on the accuracy or completeness of the contents of this document and reserves the right to make changes to specifications and product descriptions at any time without notice. Taoglas reserves all rights to this document and the information contained herein. Reproduction, use or disclosure to third parties without express permission is strictly prohibited.



1. Introduction



The Pantheon MA752.B antenna is an omnidirectional, heavy-duty, fully IP67 waterproof external multi-antenna for use in telematics, transportation and remote monitoring applications. The MA752.B is an upgrade of the MA75x series to include the bands below 500MHz to cover some of the most recent band releases.

Typical applications include:

- Gateways and Routers
- Public Safety
-

New fleet management and video location technology demand real-time video uplink and downlink. High efficiency, high gain MIMO antennas are necessary to achieve the high signal to noise ratio and throughput required to solve these challenges.

This unique antenna delivers powerful MIMO antenna technology for worldwide LTE and Wi-Fi 802.11n and emerging 802.11ac, plus GPS/GLONASS for next-generation, high-bandwidth telematics systems.

Taoglas has packed 5 high-efficiency and high-gain antennas in an extremely robust IP67 direct mount antenna package with good isolation (>10dB). The antenna has its own ground-plane and can radiate on any mounting environment like metal or plastic without affecting performance. The cables are low loss allowing for lengths of up to 5 meters (16' 4.8"), critical for buses, trains and other commercial transport applications.

Customized cable and connector are versions available. Contact your regional Taoglas customer support team for further information.

2. Specifications

GNSS Frequency Bands Covered							
GPS/QZSS	L1 1575.42MHz	L2 1227.6MHz	L5 1176.45MHz	L6 1278.75MHz			
	■	□	□	□			
GLONASS	L5R 1176.45MHz	L3PT 1201.5MHz	L2PT 1246MHz	L1CR 1575.42MHz	L1PT 1602MHz		
	□	□	□	■	■		
Galileo	E5a 1176.45MHz	E5b 1201.5MHz	E4 1215MHz	E3 1256MHz	E6 1278.75MHz	E2 1561MHz	E1 1575.42MHz
	□	□	□	□	□	□	■
BeiDou	B1 1561MHz	B2 1207.14MHz	B3 1268.52MHz				
	□	□	□				
Compass	E5B(B2)/ E6(B3) 1268.56MHz	E2(B1) 1561MHz					
	□	□					
SBAS	Omnistar 1542.5MHz	WAAS/EGN OS 1575.42MHz					
	□	■					

GNSS Electrical						
Centre Frequency			1575.42MHz / 1602MHz			
Bandwidth			10MHz			
Radiation Efficiency			50(without cable)			
VSWR			2			
Impedance			50Ω			
DC Power Input Range			3 - 5V			
DC Input	3.3V		4.0V		5.5V	
Frequency	1575.42	1602	1575.42	1602	1575.42	1602
VSWR	2	2	2	2	2	2
LNA Gain	29.2	29	31	31	32.3	32
Noise Figure	3.1	3.1	3.2	3.2	3.4	3.4
Power Consumption	7.5	7.5	9.4	9.4	15	15
Band Attenuation	1520MHz: -20dB 1642MHz: -20dB		1520MHz: -20dB 1642MHz: -20dB		1520MHz: -20dB 1642MHz: -20dB	

5G/4G MIMO								
Band	Frequency (MHz)		Efficiency (%)	Average Gain (dB)	Peak Gain (dBi)	VSWR	Impedance	Polarization
4G/3G Band 31	430~470	MIMO 1	18	-7.5	-1.1	3 Max	50Ω	Linear
		MIMO 2	16	-8.2	-2.2			
5G NR/4G Band 5,8,12,13,14,17,18,20, 26,27,28, 29,71	617~960	MIMO 1	54	-2.7	3.8			
		MIMO 2	57	-2.5	2.4			
5G NR/4G Band 21,32,74,75,76	1427~1518	MIMO 1	39	-4.1	1.6			
		MIMO 2	34	-4.8	1.6			
4G/3G Band 1,2,3,4,9,23,25,35,39,66	1710~2200	MIMO 1	31	-5.2	1.4			
		MIMO 2	33	-4.9	1.1			
Wi-Fi 2400	2400~2500	MIMO 1	25	-6.0	-0.5			
		MIMO 2	27	-5.6	-0.3			
4G/3G Band 7,38,41	2490~2690	MIMO 1	22	-6.7	-0.6			
		MIMO 2	24	-6.2	0.2			
5G NR/4G Band 22,42,43,48,77,78,79	3300~5000	MIMO 1	18	-8.2	2.8			
		MIMO 2	21	-8.1	6.0			
LTE5200/ Wi-Fi 5800	5150~5925	MIMO 1	25	-6.2	4.9			
		MIMO 2	32	-5.0	5.8			

Wi-Fi MIMO 2.4GHz / 5GHz							
Frequency (MHz)		Efficiency (%)	Average Gain (dB)	Peak Gain (dBi)	VSWR	Polarization	Impedance
2400~2500	MIMO 1	36	-4.5	3.7	2 Max	Linear	50 Ω
	MIMO 2	57	-2.4	2.2			
5150~5850	MIMO 1	51	-2.9	5.4			
	MIMO 2	50	-3.1	4.8			

Mechanical	
Antenna Dimensions	Height 82.4mm x Diameter 143.19mm
Casing	Wonderloy PC-540 PC/ABS Alloy
Waterproof	IP67
Cables	5G/4G & Wi-Fi – 3m CFD-200 GNSS – 3m RG-174
Connectors	GNSS & 5G/4G – SMA(M) Wi-Fi – RP-SMA(M)
Base and thread	CAN10 Zinc Alloy
Thread diameter	M30 x 2 (30mm)
Nut	Nickel Plated Steel
Foam	3M 9448HK
Weight(kg)	1.29
Recommended Torque for Mounting	5-7Nm
Environmental	
Operation Temperature	-40°C to 85°C
Storage Temperature	-40°C to 90°C
Humidity	Non-condensing 65°C 95% RH

5G/4G Bands			
Band Number	5G NR / FR1 / LTE / LTE-Advanced / WCDMA / HSPA / HSPA+ / TD-SCDMA		
	Uplink	Downlink	Covered
1	UL: 1920 to 1980	DL: 2110 to 2170	✓
2	UL: 1850 to 1910	DL: 1930 to 1990	✓
3	UL: 1710 to 1785	DL: 1805 to 1880	✓
4	UL: 1710 to 1755	DL: 2110 to 2155	✓
5	UL: 824 to 849	DL: 869 to 894	✓
7	UL: 2500 to 2570	DL: 2620 to 2690	✓
8	UL: 880 to 915	DL: 925 to 960	✓
9	UL: 1749.9 to 1784.9	DL: 1844.9 to 1879.9	✓
11	UL: 1427.9 to 1447.9	DL: 1475.9 to 1495.9	✓
12	UL: 699 to 716	DL: 729 to 746	✓
13	UL: 777 to 787	DL: 746 to 756	✓
14	UL: 788 to 798	DL: 758 to 768	✓
17	UL: 704 to 716	DL: 734 to 746	✓
18	UL: 815 to 830	DL: 860 to 875	✓
19	UL: 830 to 845	DL: 875 to 890	✓
20	UL: 832 to 862	DL: 791 to 821	✓
21	UL: 1447.9 to 1462.9	DL: 1495.9 to 1510.9	✓
22	UL: 3410 to 3490	DL: 3510 to 3590	✓
23	UL: 2000 to 2020	DL: 2180 to 2200	✓
24	UL: 1625.5 to 1660.5	DL: 1525 to 1559	✓
25	UL: 1850 to 1915	DL: 1930 to 1995	✓
26	UL: 814 to 849	DL: 859 to 894	✓
27	UL: 807 to 824	DL: 852 to 869	✓
28	UL: 703 to 748	DL: 758 to 803	✓
29	UL: -	DL: 717 to 728	✓
30	UL: 2305 to 2315	DL: 2350 to 2360	✓
31	UL: 452.5 to 457.5	DL: 462.5 to 467.5	✓
32	UL: -	DL: 1452 - 1496	✓
35		1850 to 1910	✓
38		2570 to 2620	✓
39		1880 to 1920	✓
40		2300 to 2400	✓
41		2496 to 2690	✓
42		3400 to 3600	✓
43		3600 to 3800	✓
48		3550 to 3700	✓
66	UL: 1710-1780	DL: 2110-2200	✓
71		617 to 698	✓
74/75/76		1427 to 1518	✓
78		3300 to 3800	✓
79		4400 to 5000	✓
85	698-716	728-746	✓

3. Antenna Characteristics

3.1 Return Loss

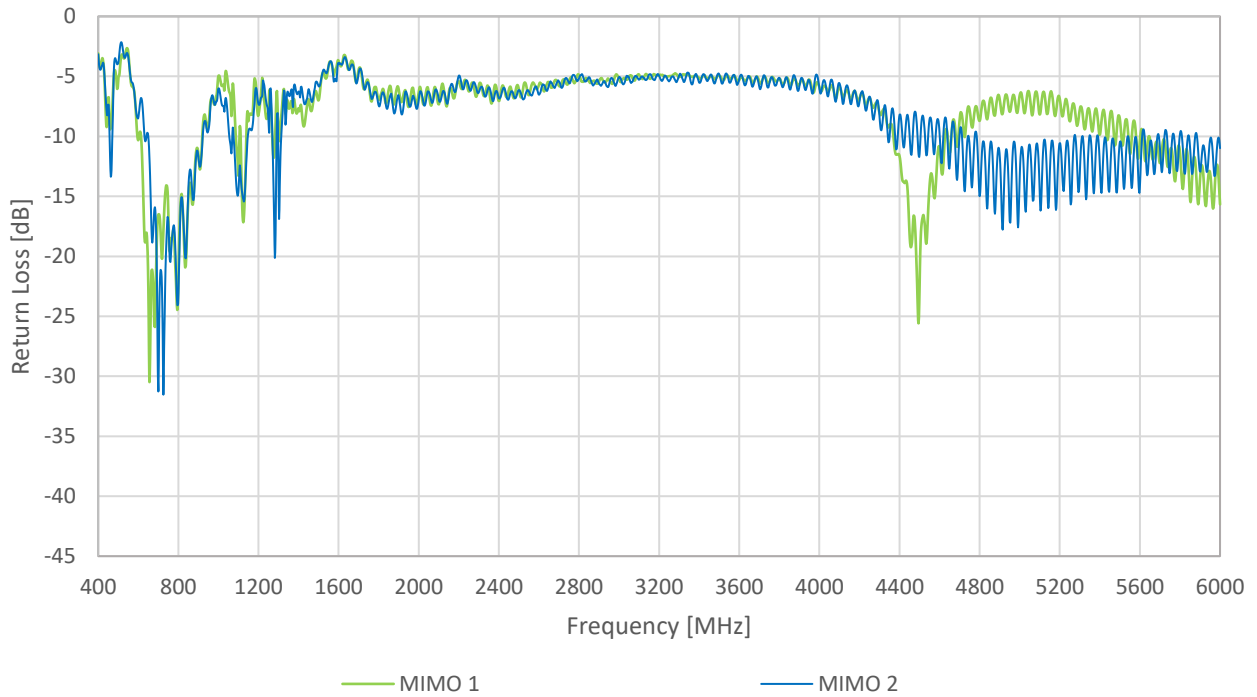

3.2 Efficiency

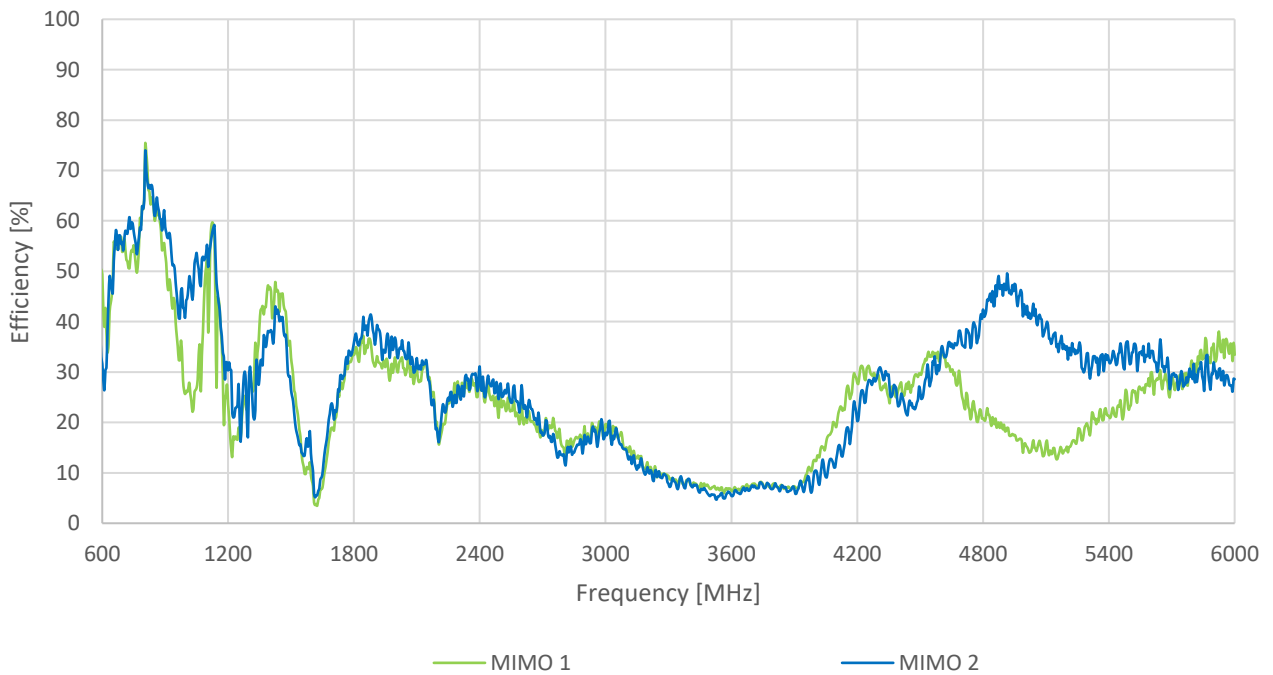

3.3 Peak Gain

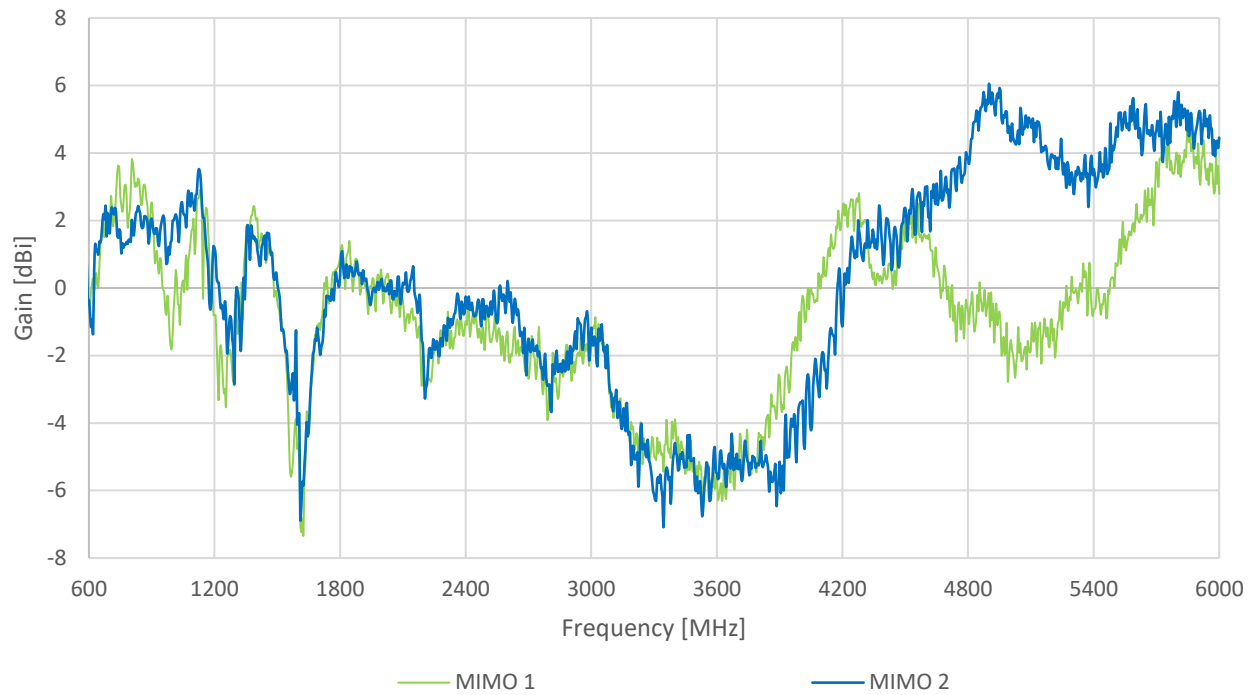

3.4 Average Gain

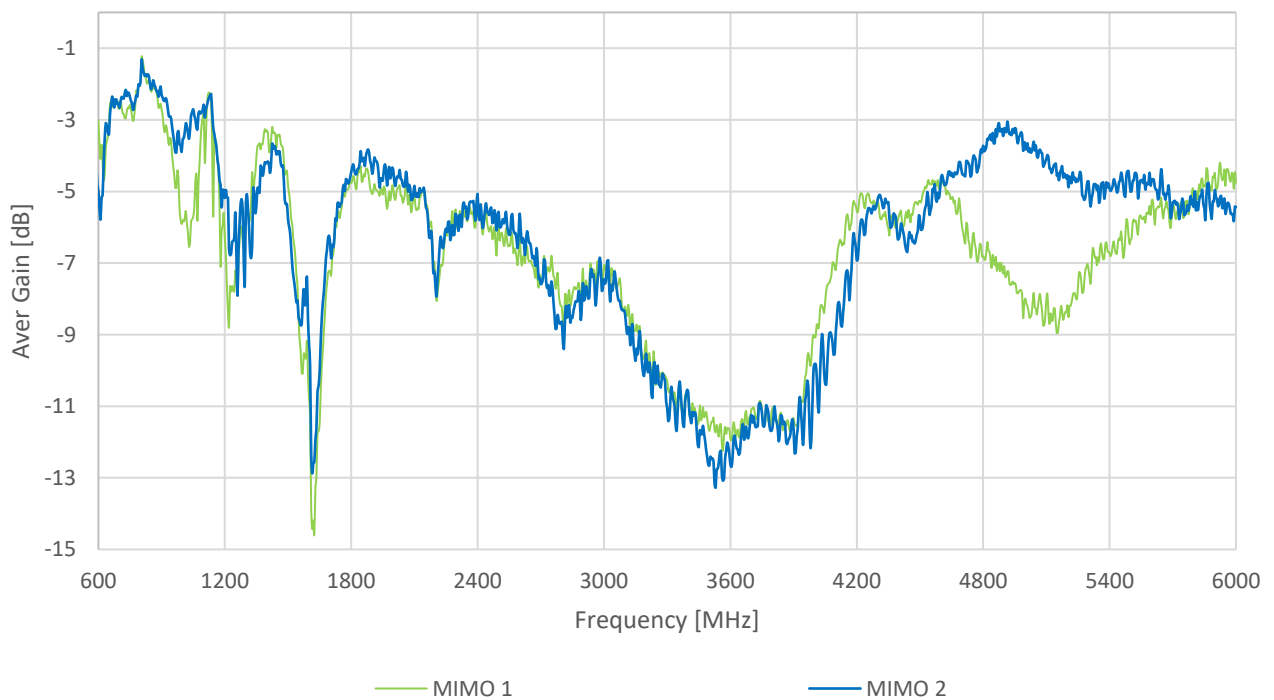

3.5 Return Loss – WiFi MIMO 1 &2 (2.4/5 GHz)

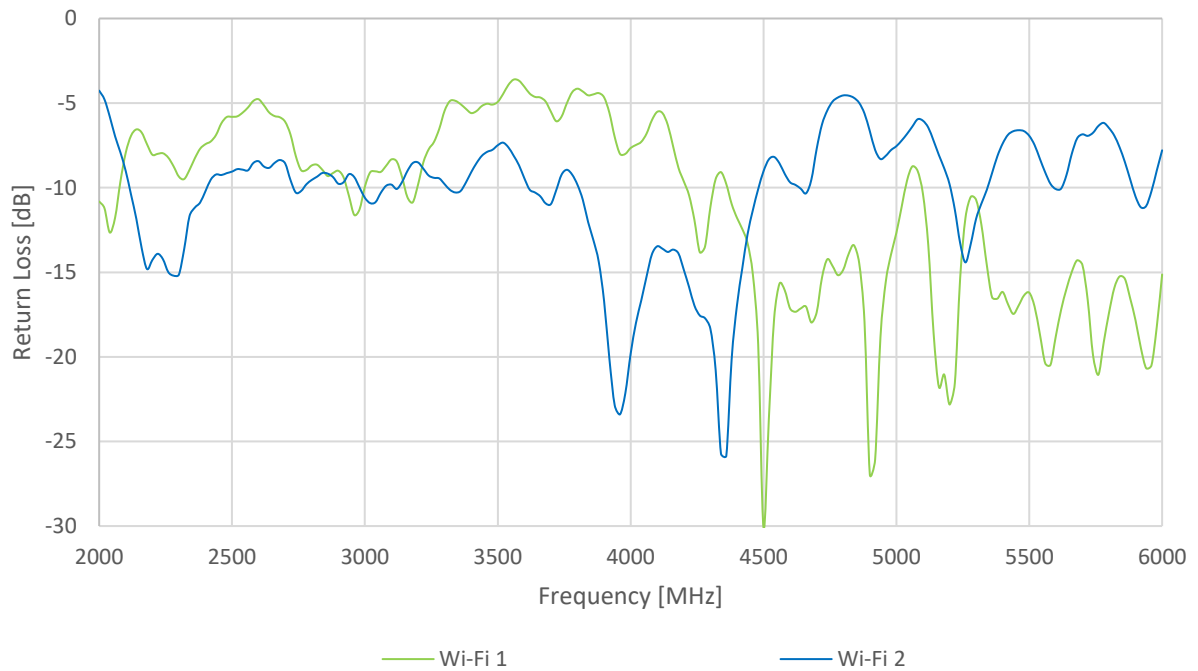

3.6 VSWR - WiFi MIMO 1 &2 (2.4/5 GHz)

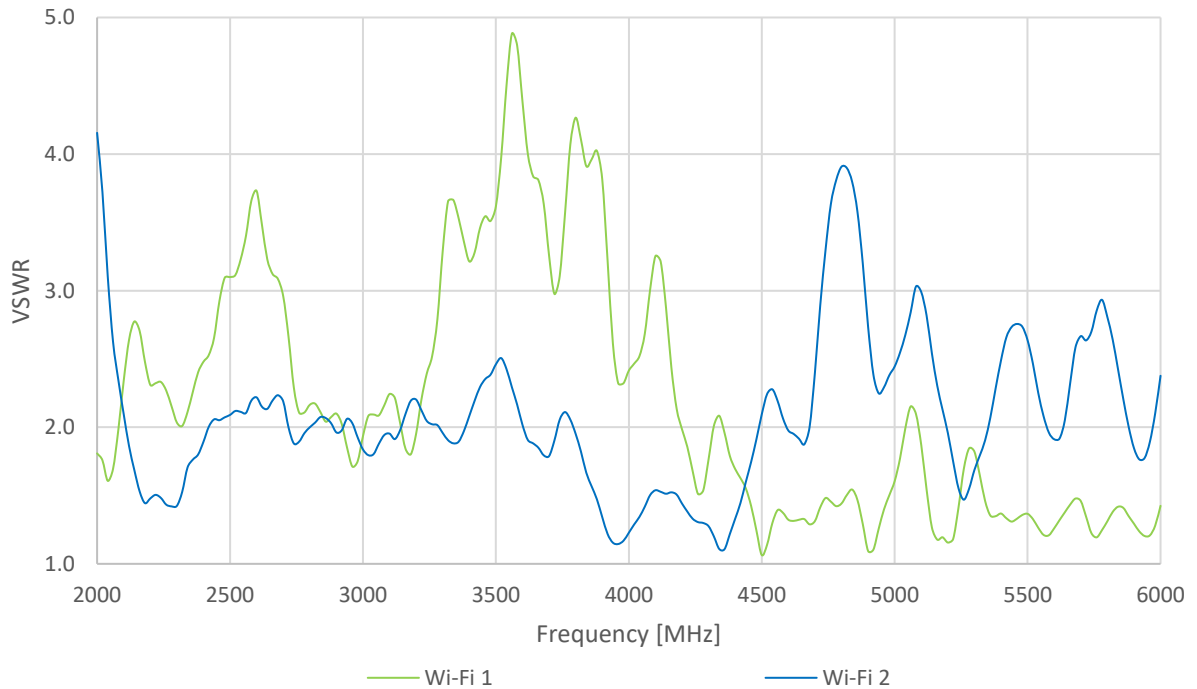

3.7 Isolation – WiFi MIMO 1 &2 (2.4/5 GHz)

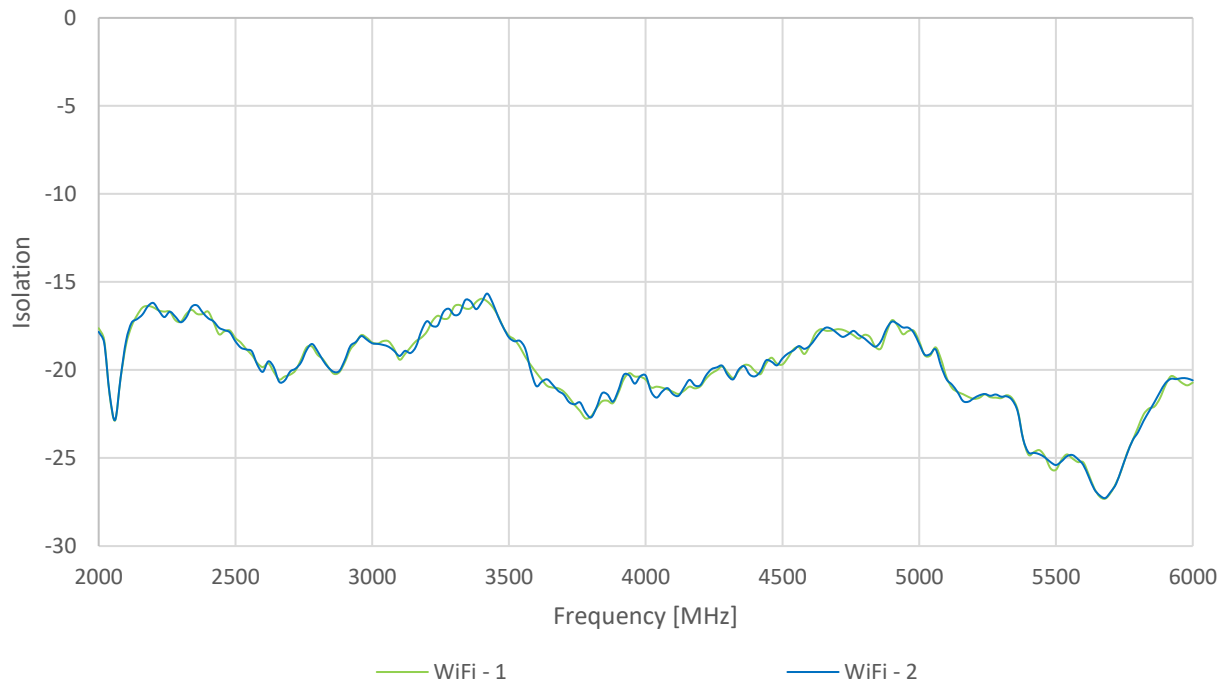

3.8 Efficiency - WiFi MIMO 1 &2 (2.4/5 GHz)

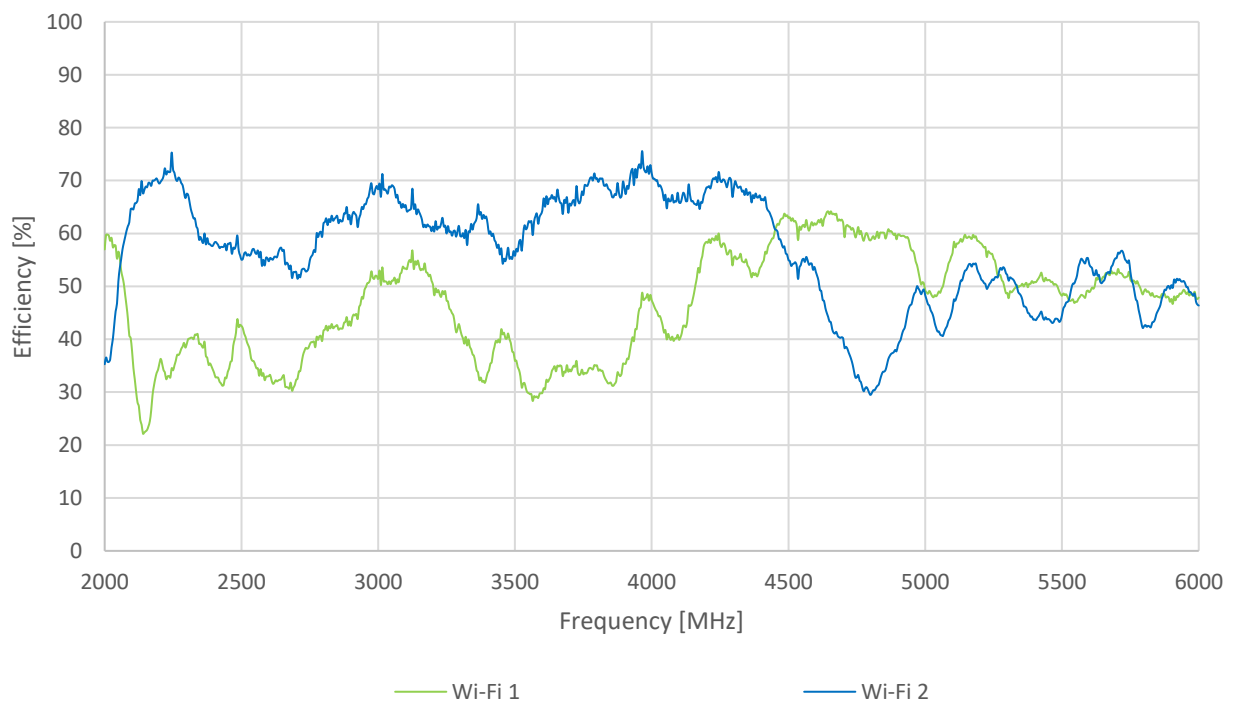

3.9 Peak Gain - WiFi MIMO 1 & 2 (2.4/5 GHz)

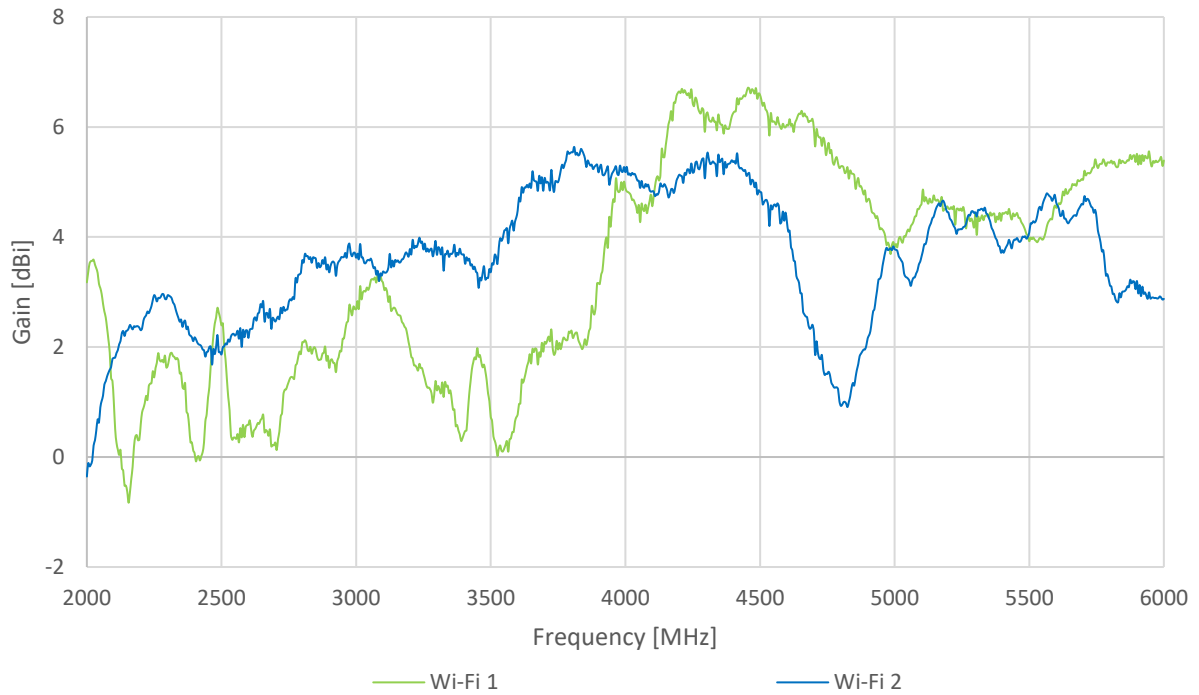

3.10 Average Gain - WiFi MIMO 1 & 2 (2.4/5 GHz)

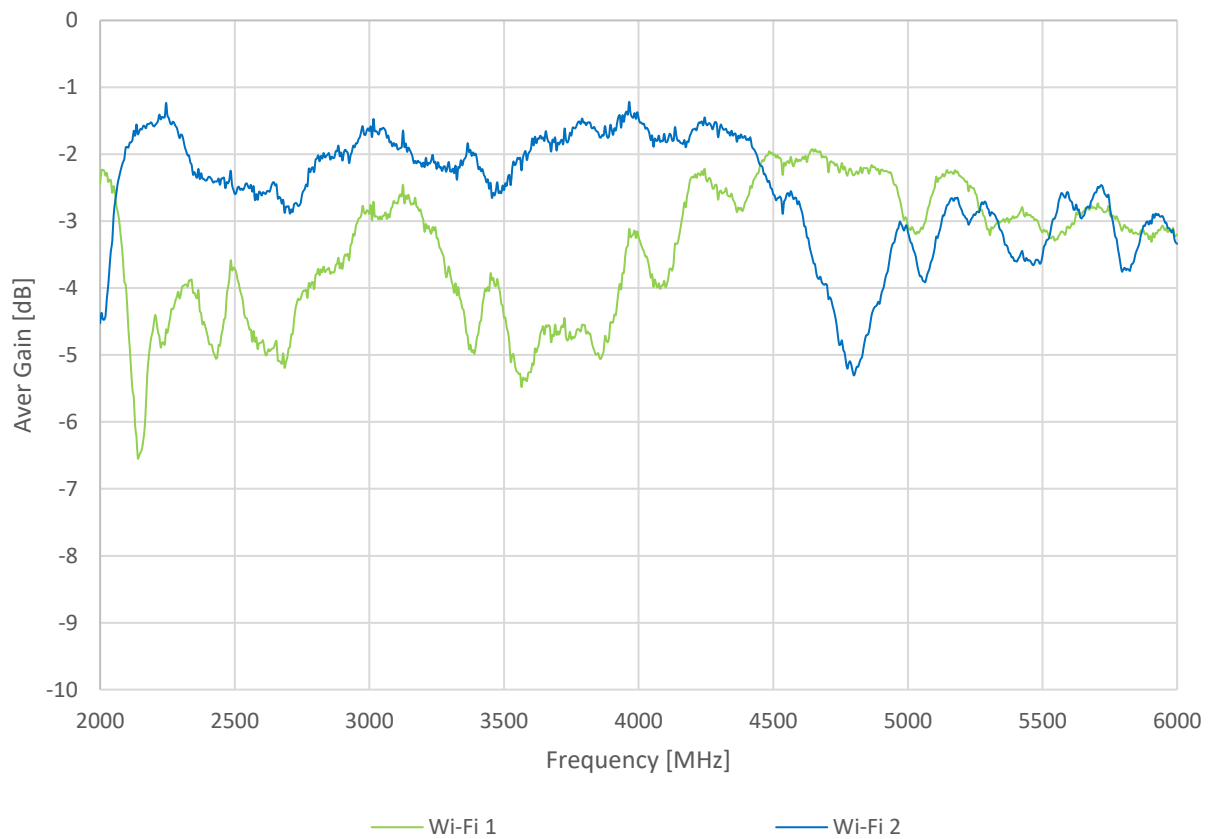

3.11 Block Diagram - GPS/GLONASS/GALILEO

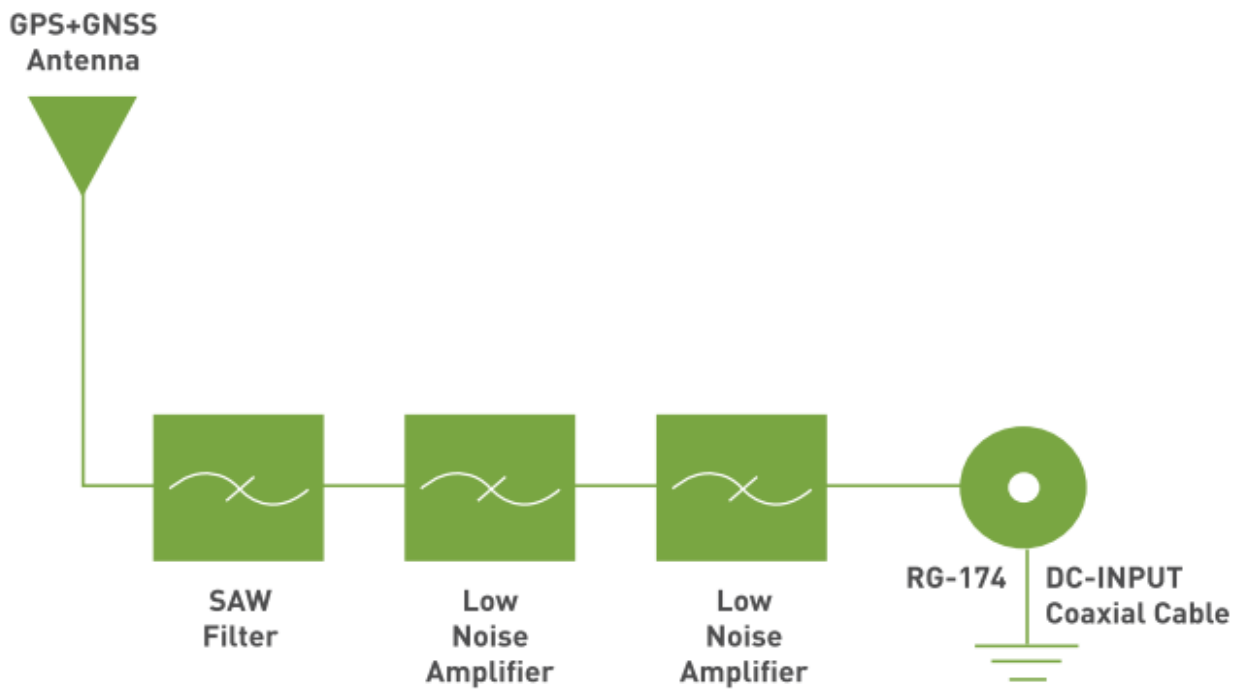

3.12 Return Loss - GNSS

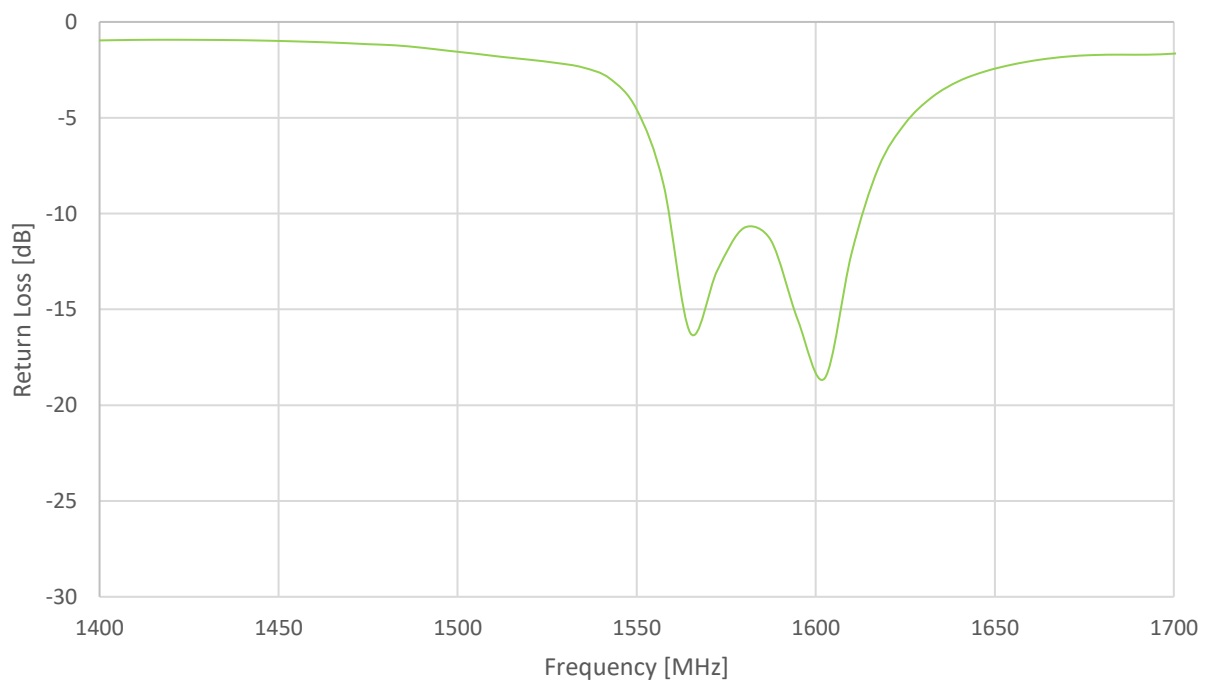

3.13 GNSS – Efficiency

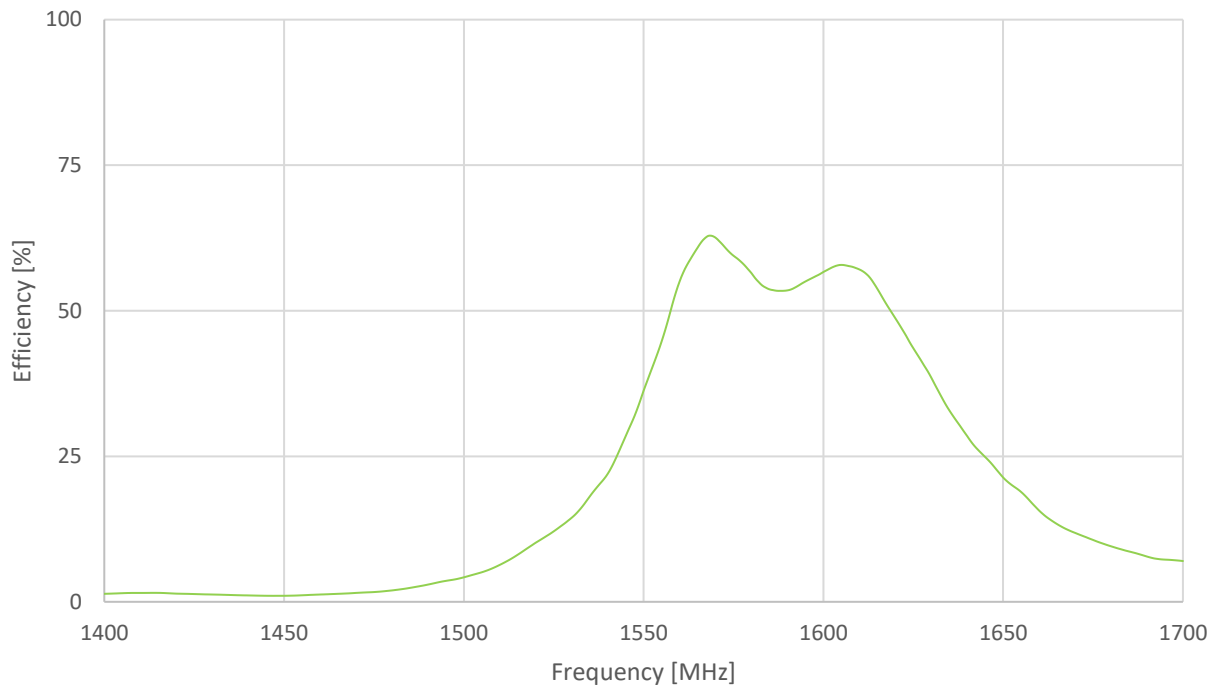

3.14 GNSS – Peak Gain

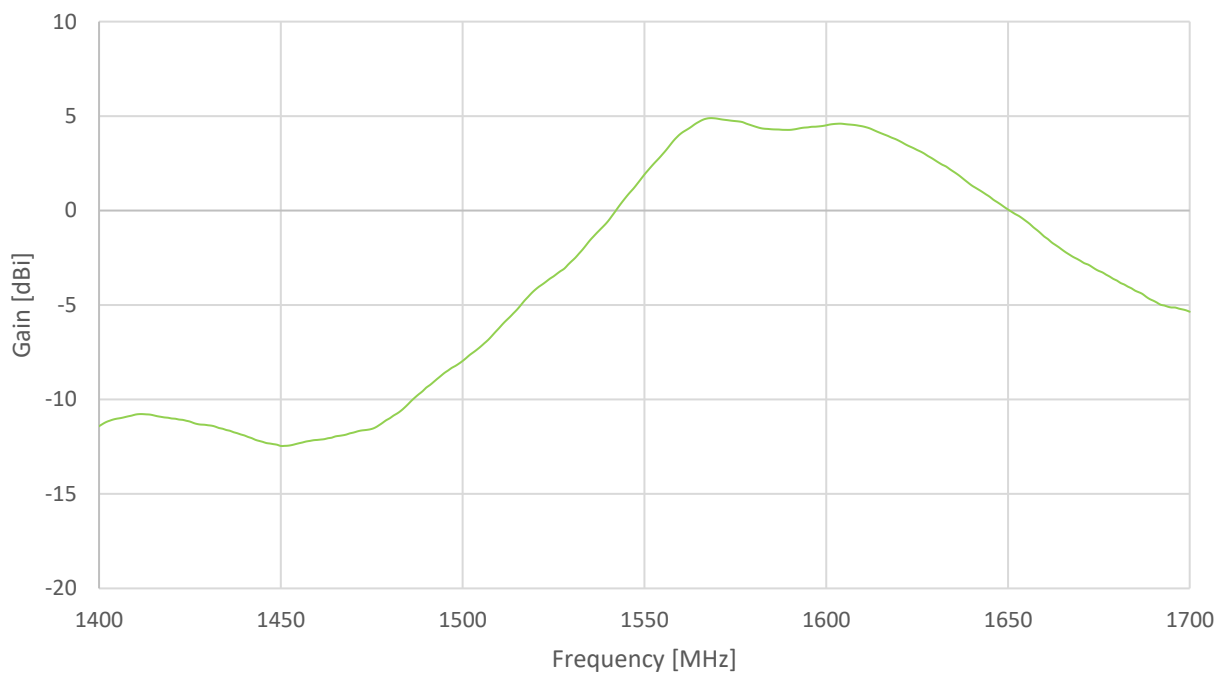

3.15 GNSS – Average Gain

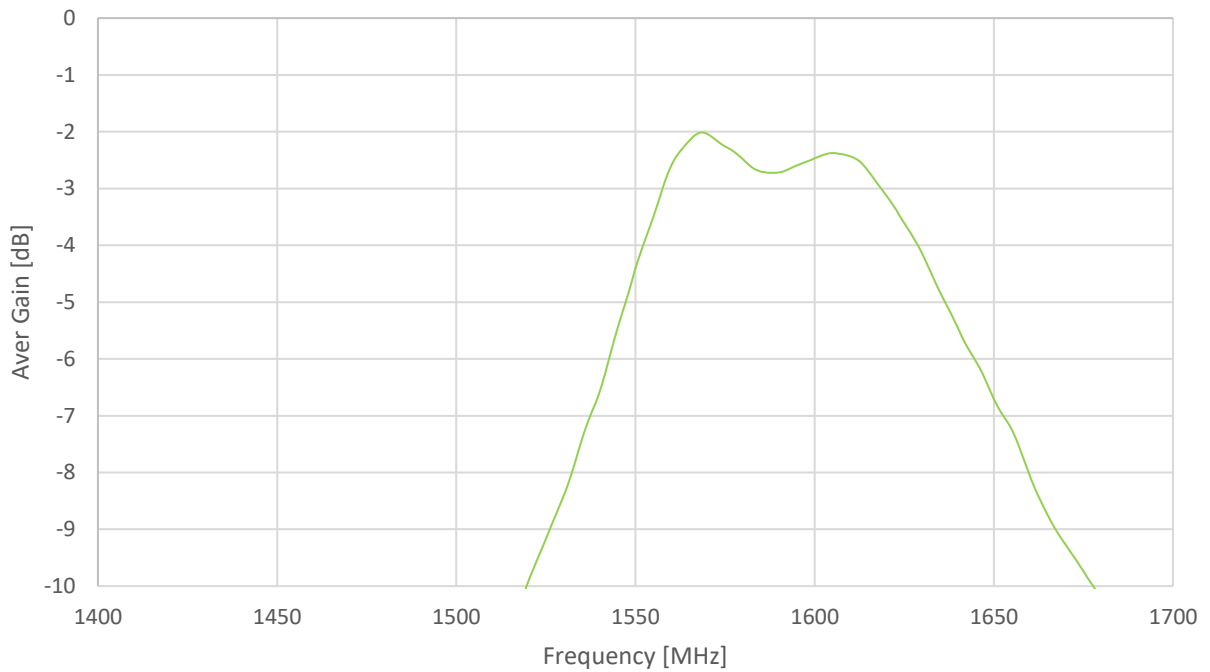

3.16 GNSS - Axial Ratio

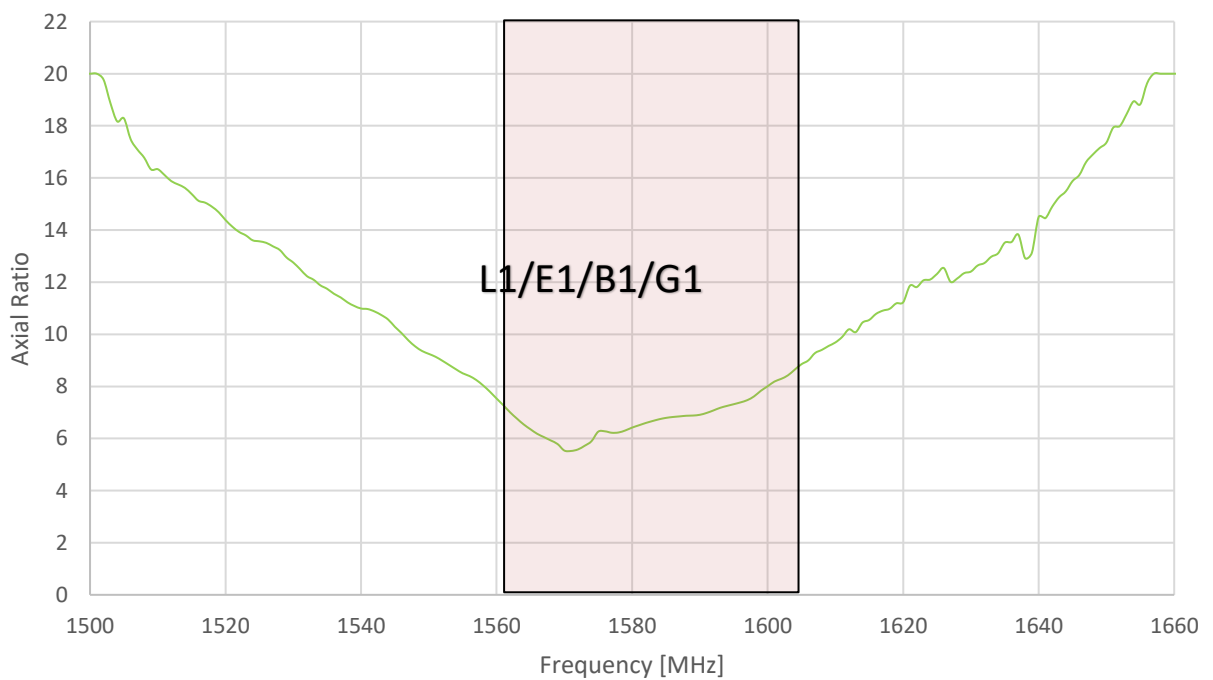

4. Radiation Patterns

4.1 Test Setup

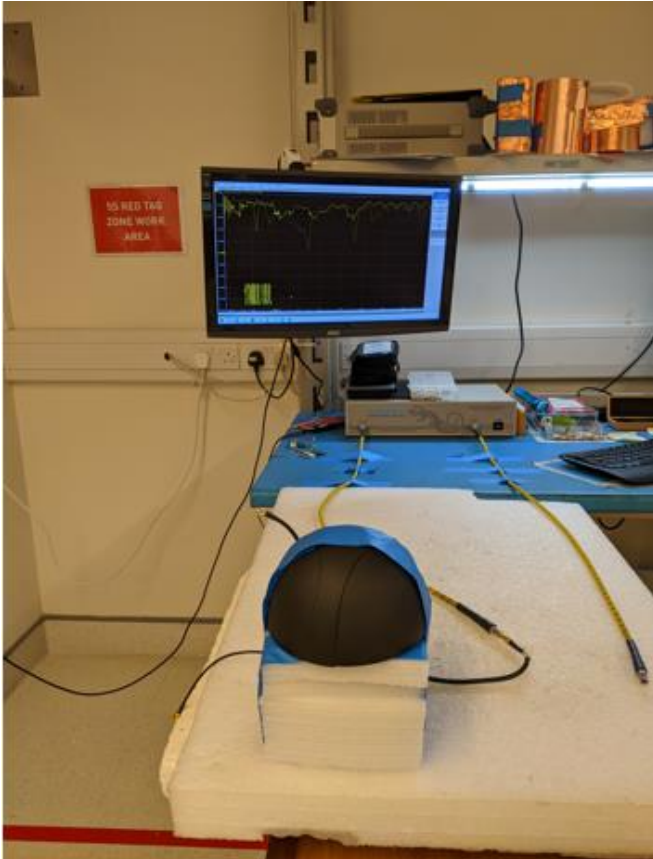

VNA Test Set-up

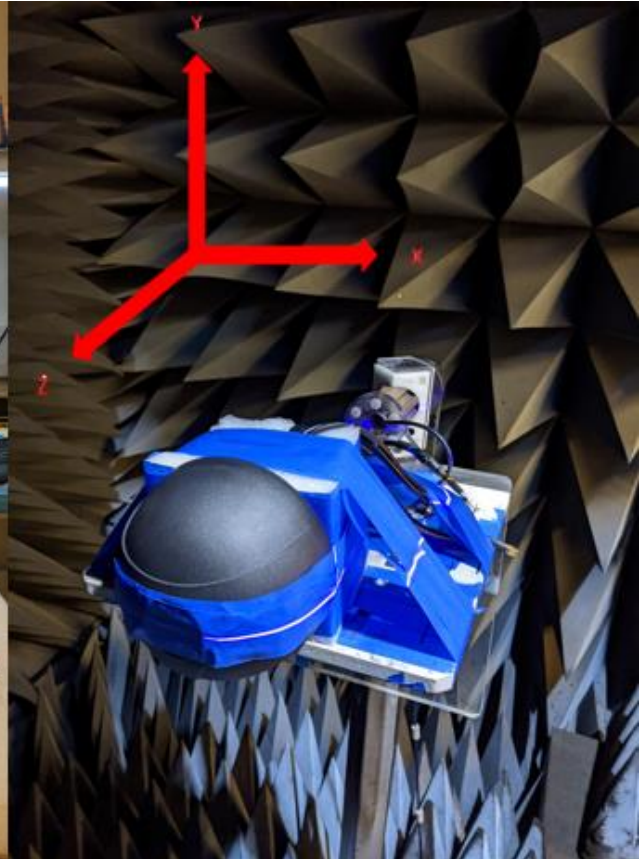

Chamber Test Set-up

4.2 450MHz 3D and 2D Cellular Radiation Patterns

MIMO 1

MIMO 2

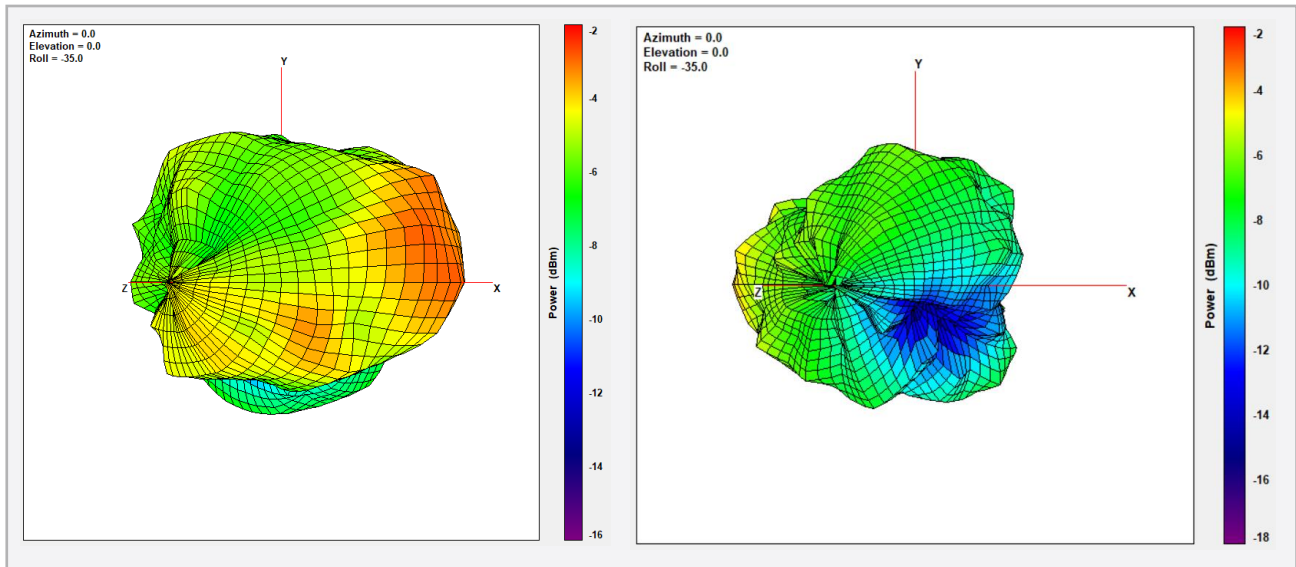

XY Plane

XZ Plane

YZ Plane

MIMO 1

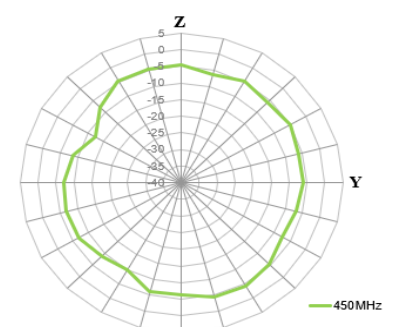
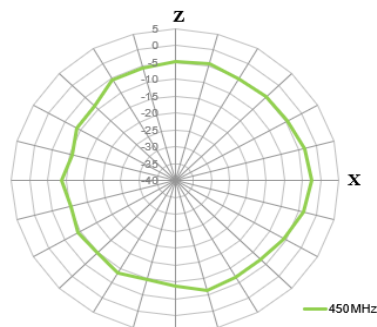
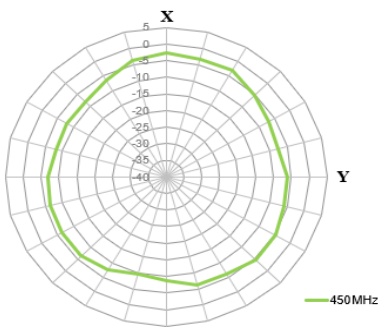

MIMO 2

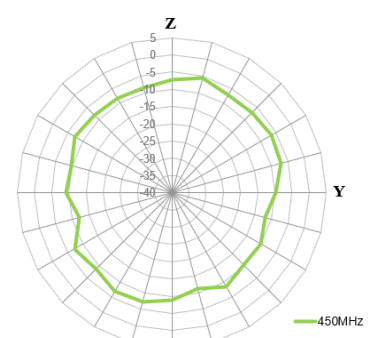
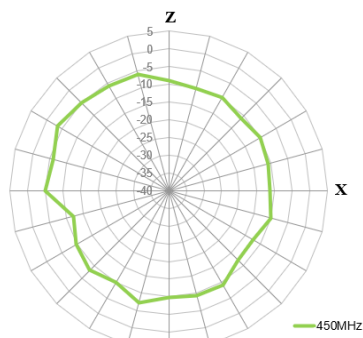
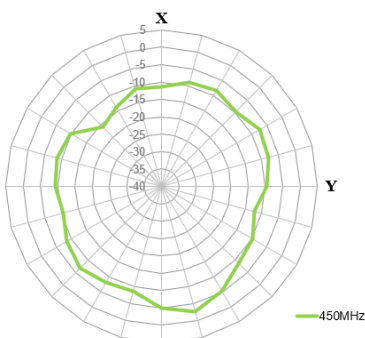

470MHz

MIMO 1

MIMO 2

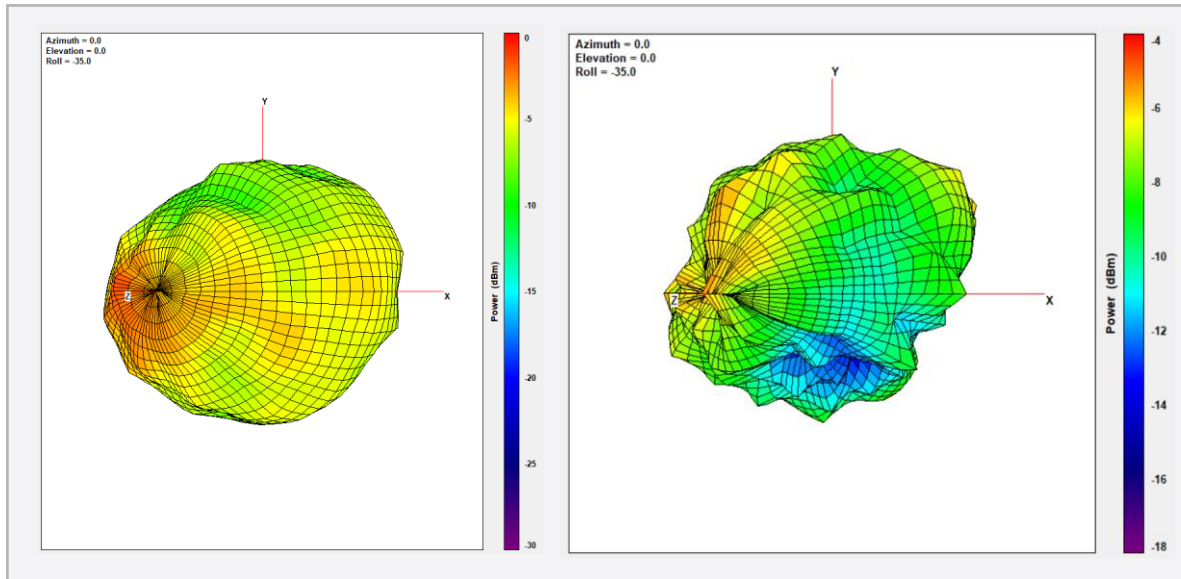

XY Plane

XZ Plane

YZ Plane

MIMO 1

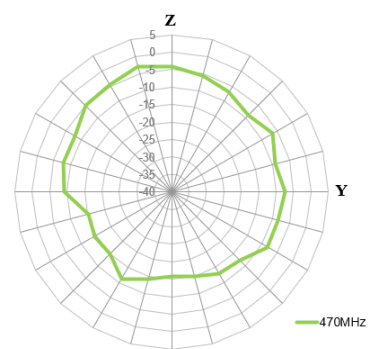
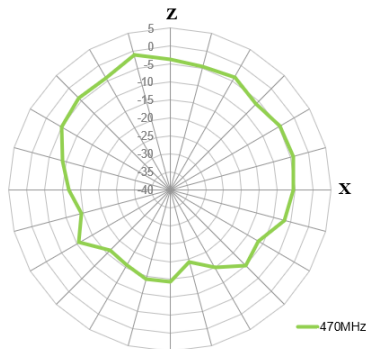
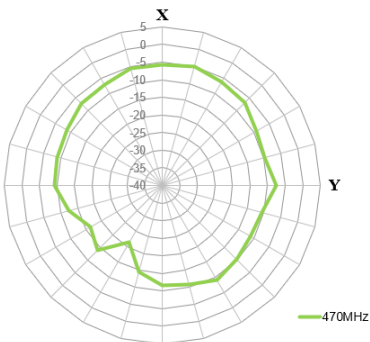

MIMO 2

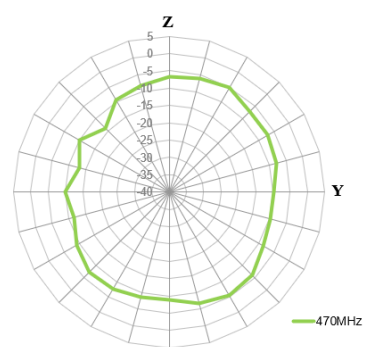
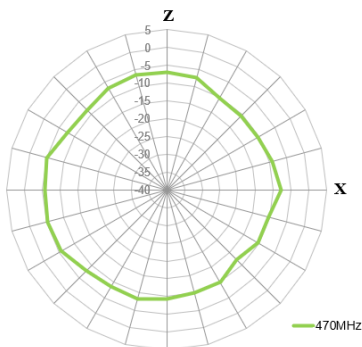
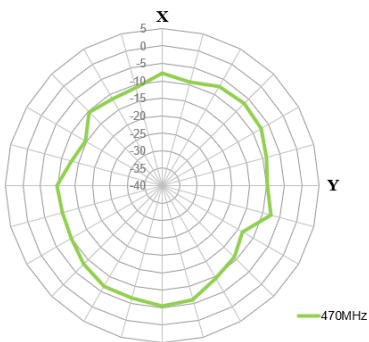

705MHz

MIMO 1

MIMO 2

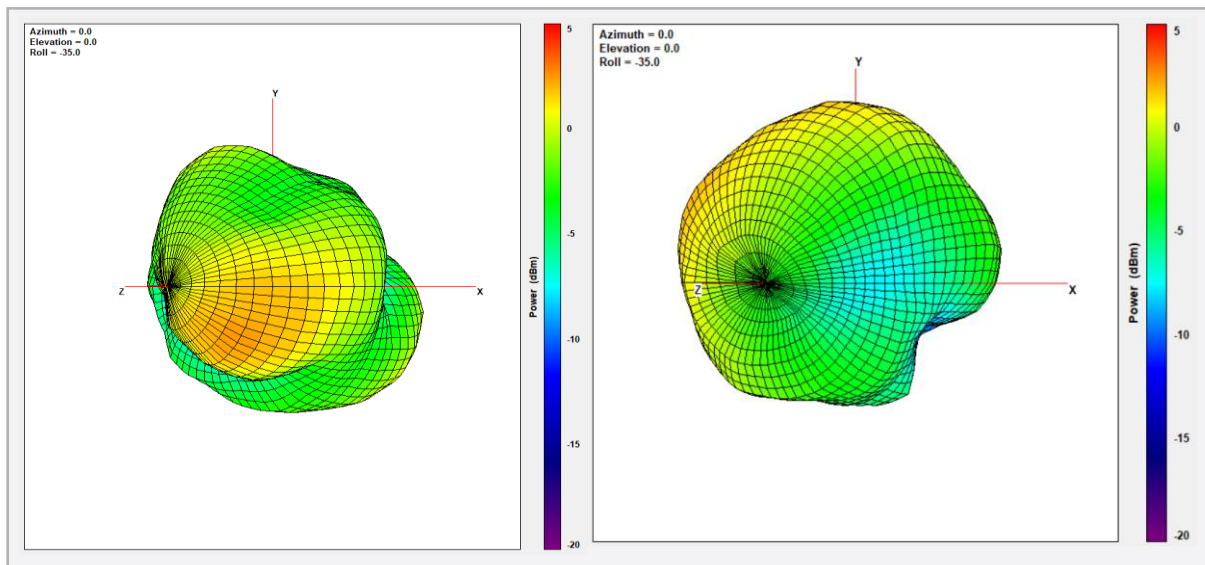

XY Plane

XZ Plane

YZ Plane

MIMO 1

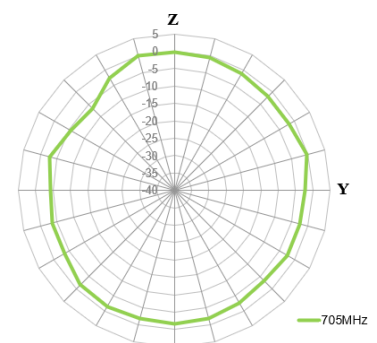
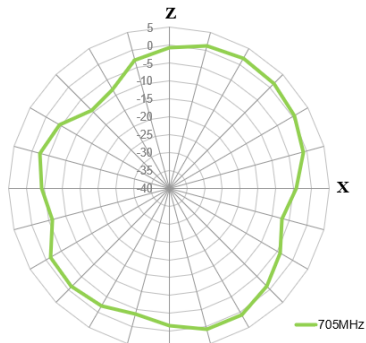
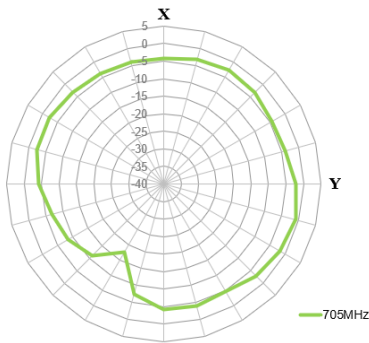

MIMO 2

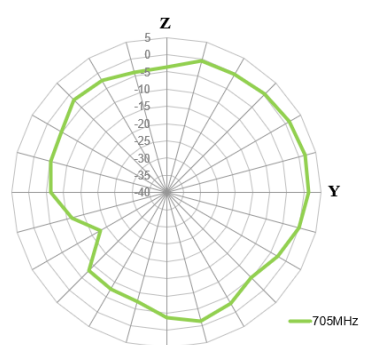
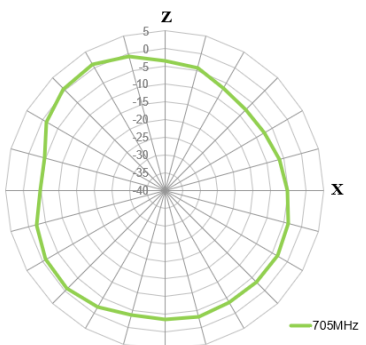
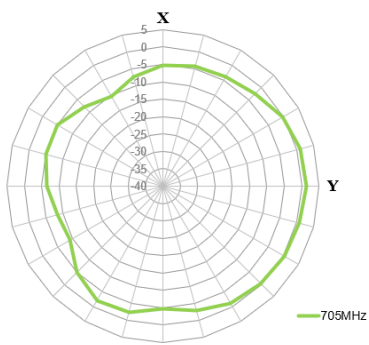

750MHz

MIMO 1

MIMO 2

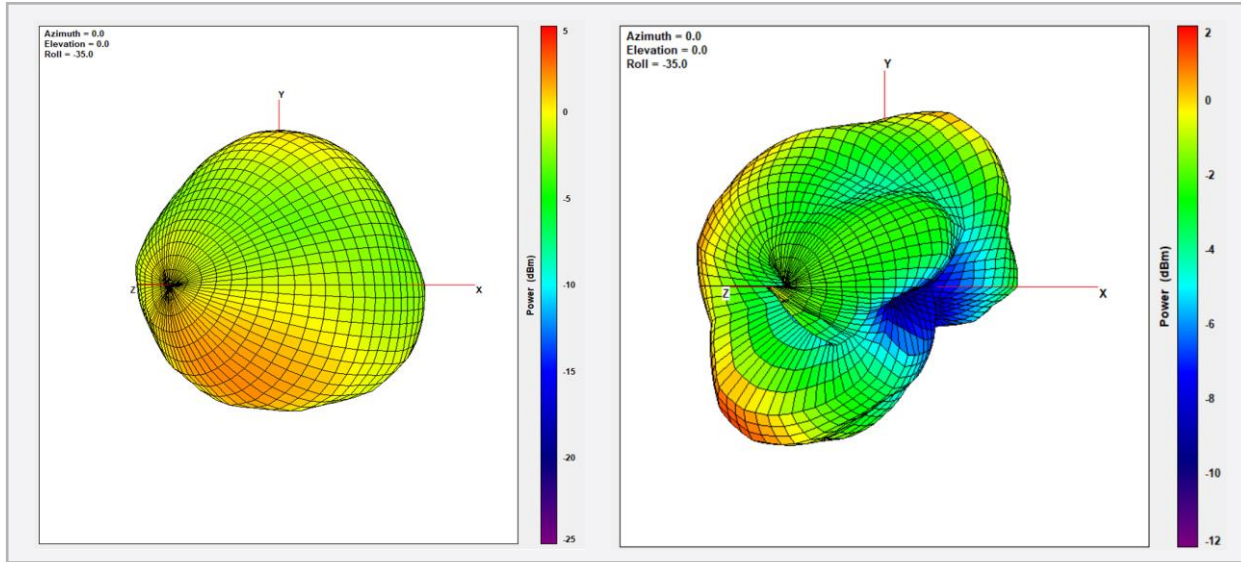

XY Plane

XZ Plane

YZ Plane

MIMO 1

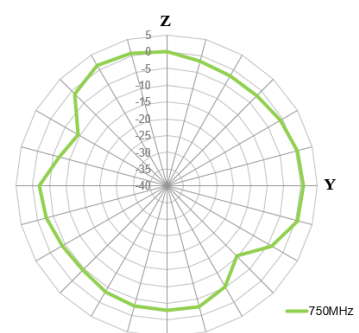
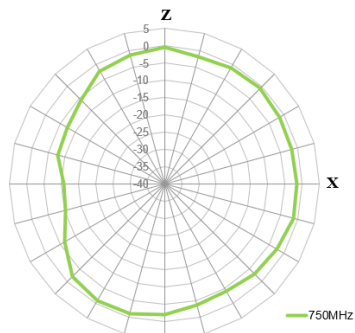
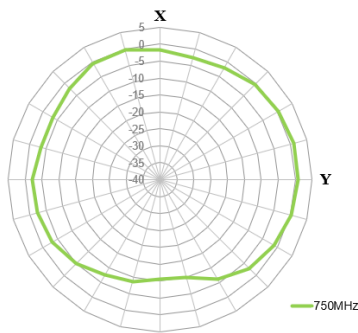

MIMO 2

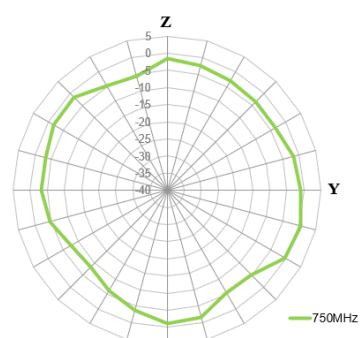
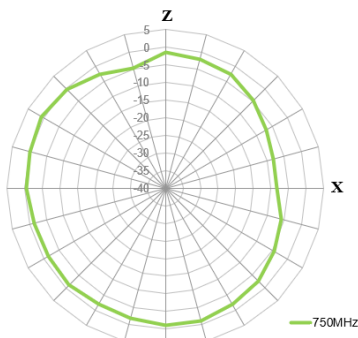
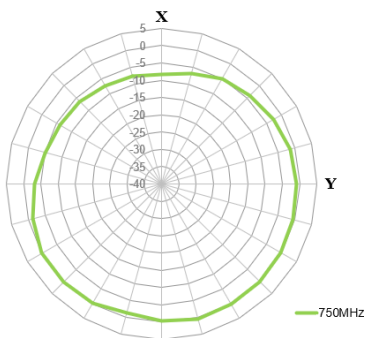

825MHz

MIMO 1

MIMO 2

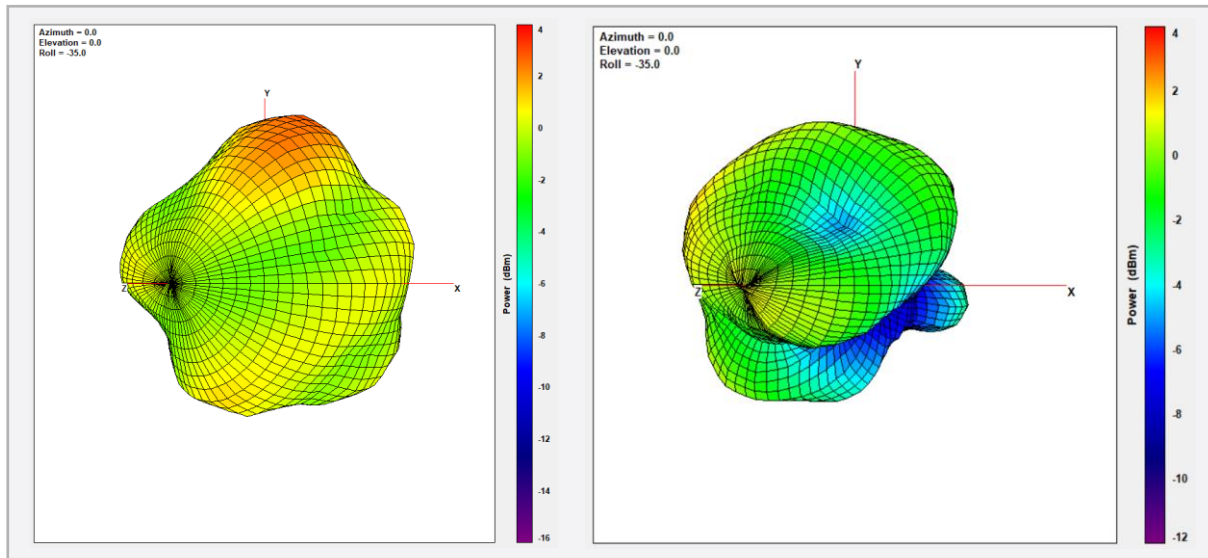

XY Plane

XZ Plane

YZ Plane

MIMO 1

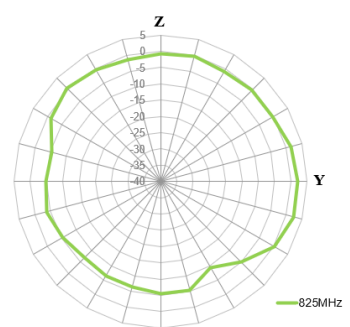
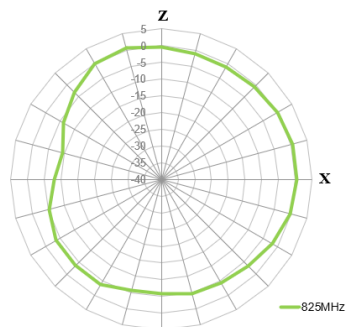
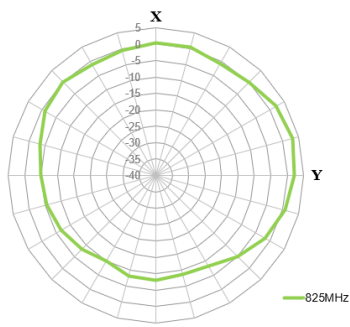

MIMO 2

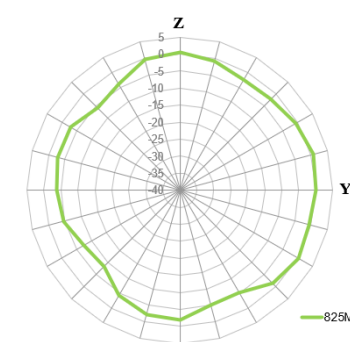
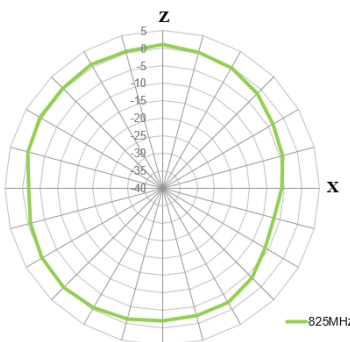
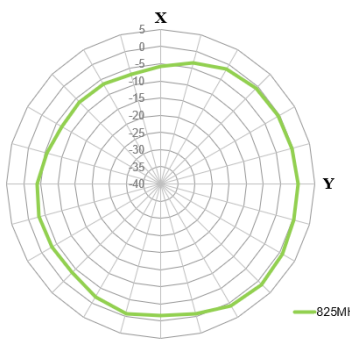

960MHz

MIMO 1

MIMO 2

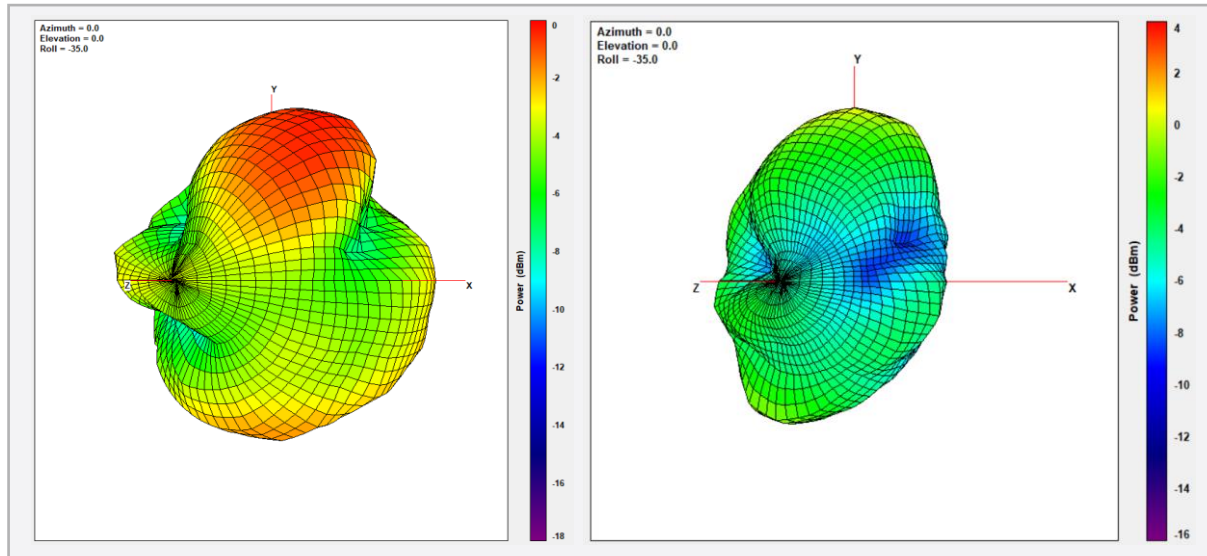

XY Plane

XZ Plane

YZ Plane

MIMO 1

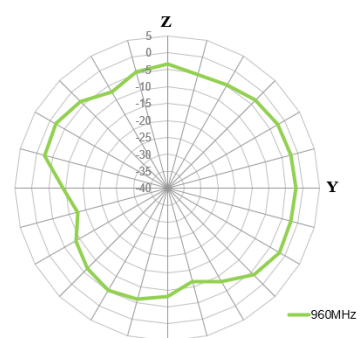
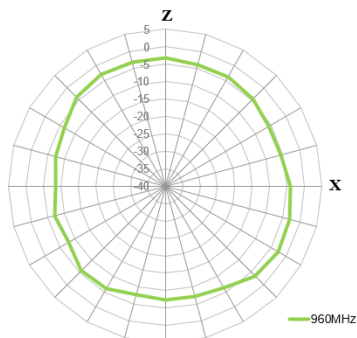
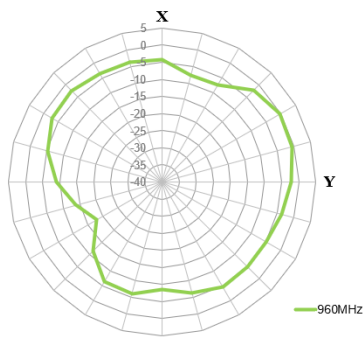

MIMO 2

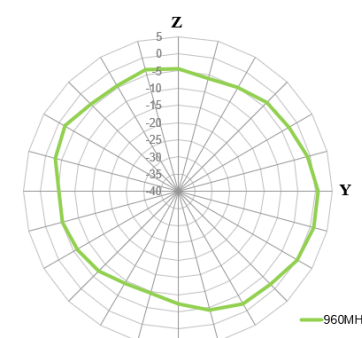
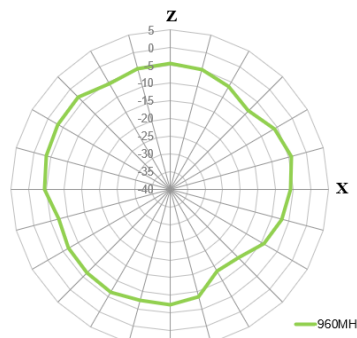
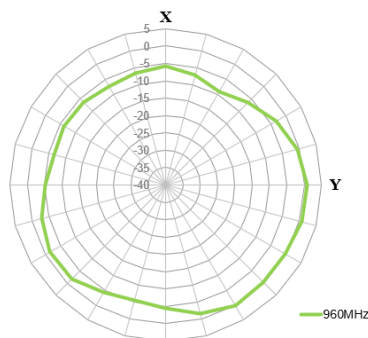

1710MHz

MIMO 1

MIMO 2

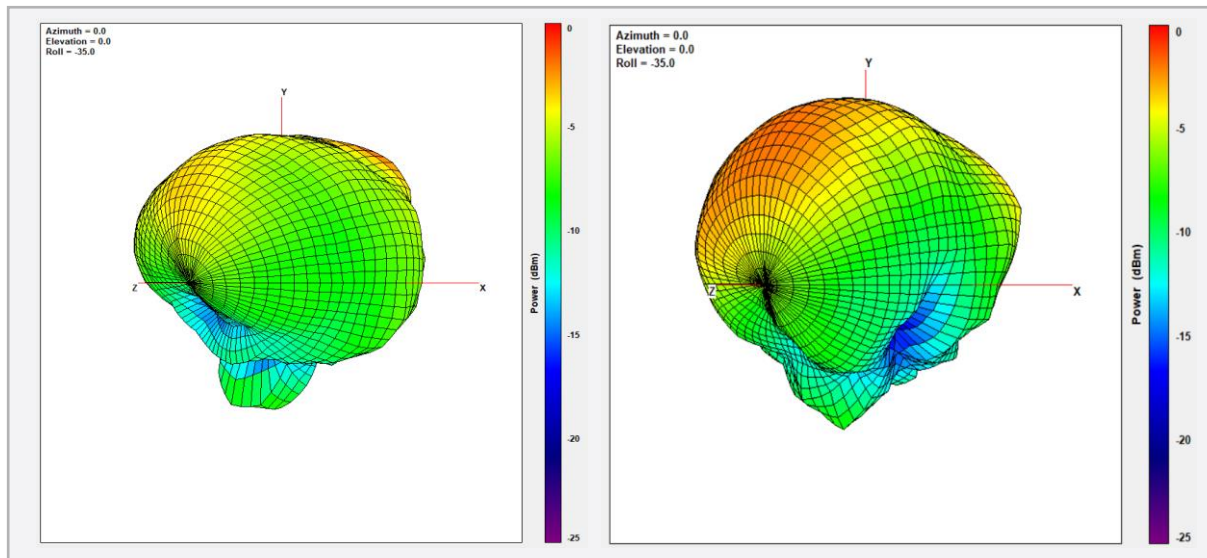

XY Plane

XZ Plane

YZ Plane

MIMO 1

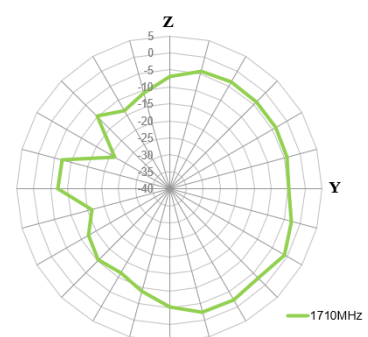
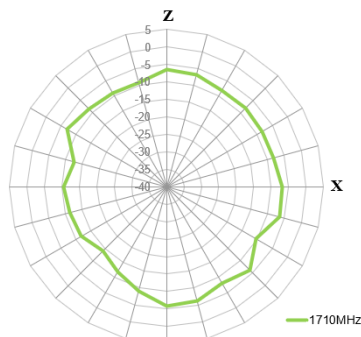
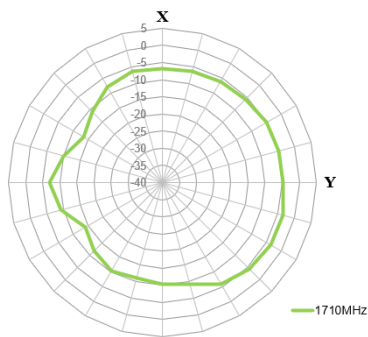

MIMO 2

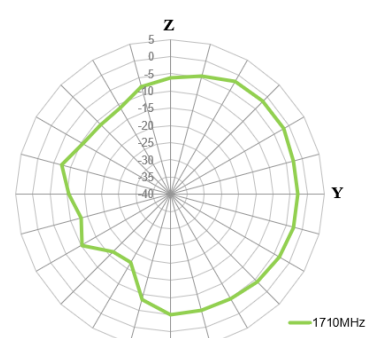
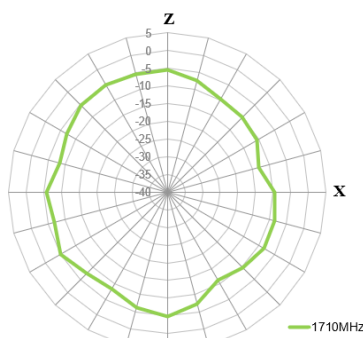
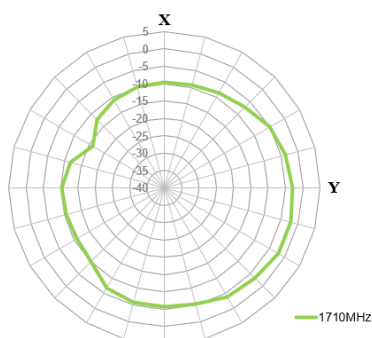

1805MHz

MIMO 1

MIMO 2

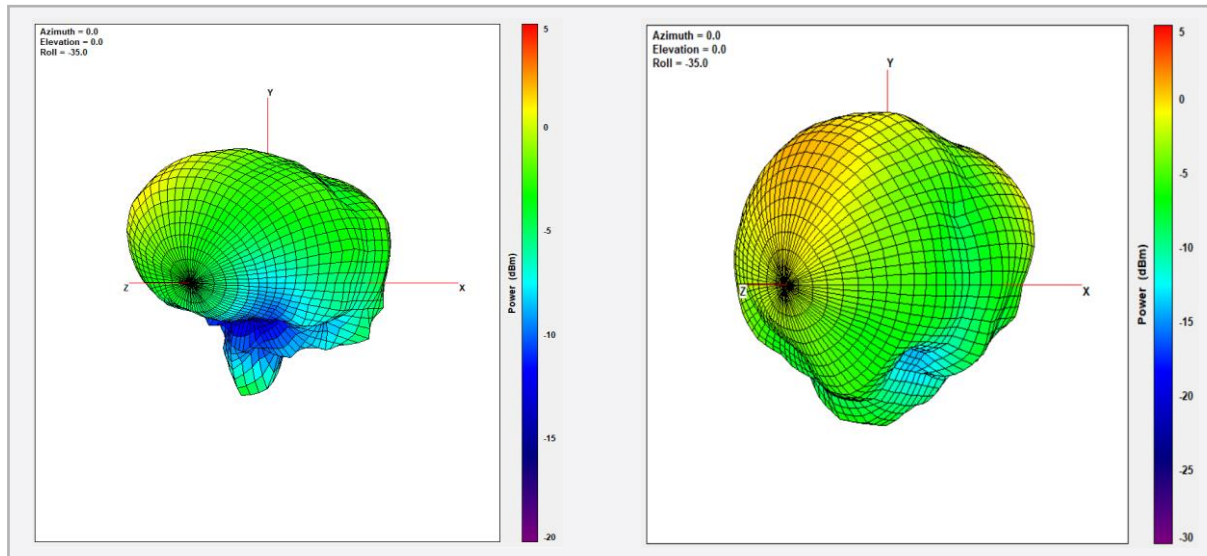

XY Plane

XZ Plane

YZ Plane

MIMO 1

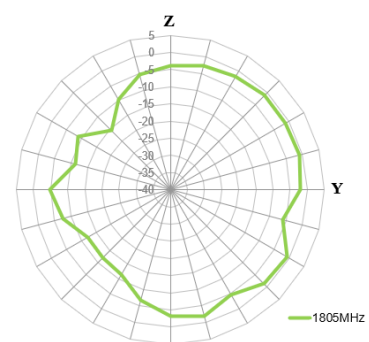
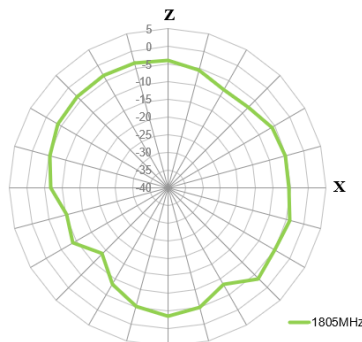
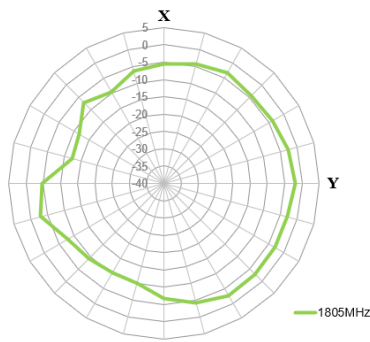

MIMO 2

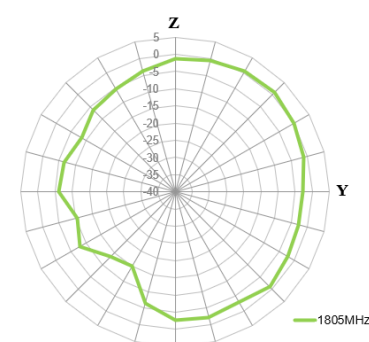
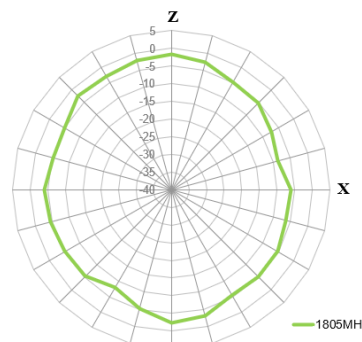
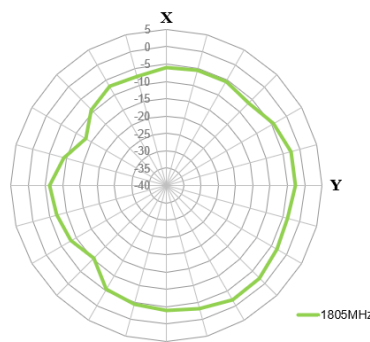

1990MHz

MIMO 1

MIMO 2

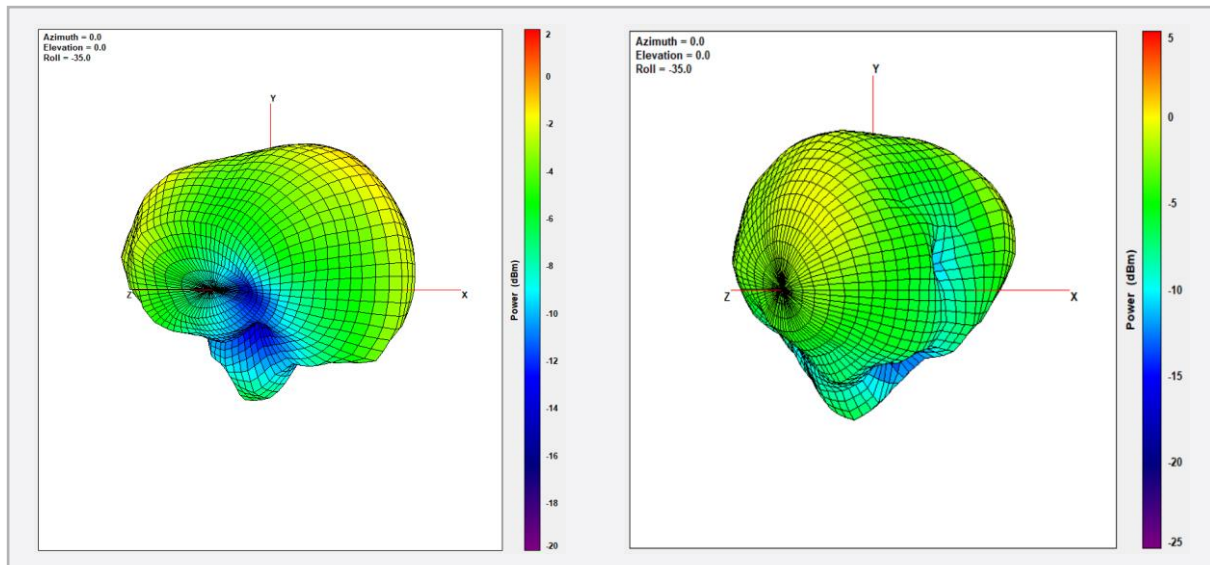

XY Plane

XZ Plane

YZ Plane

MIMO 1

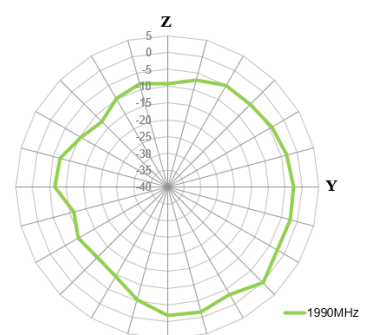
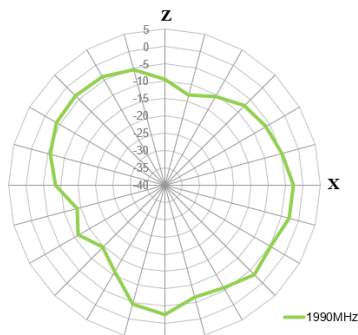
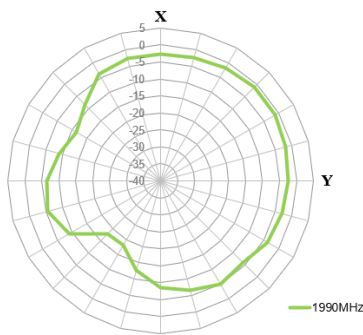

MIMO 2

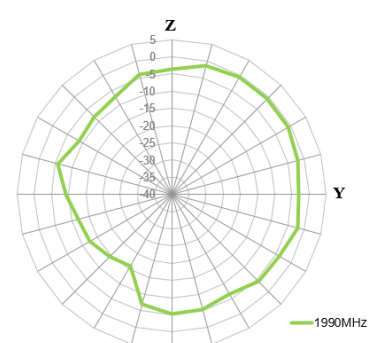
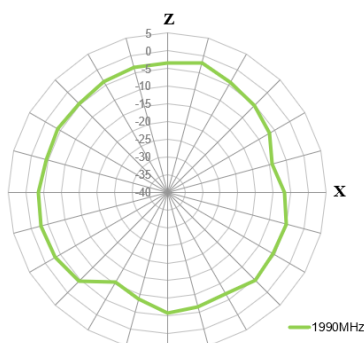
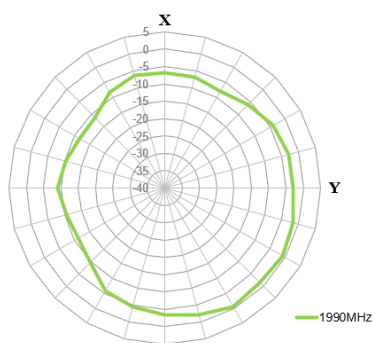

2170MHz

MIMO 1

MIMO 2

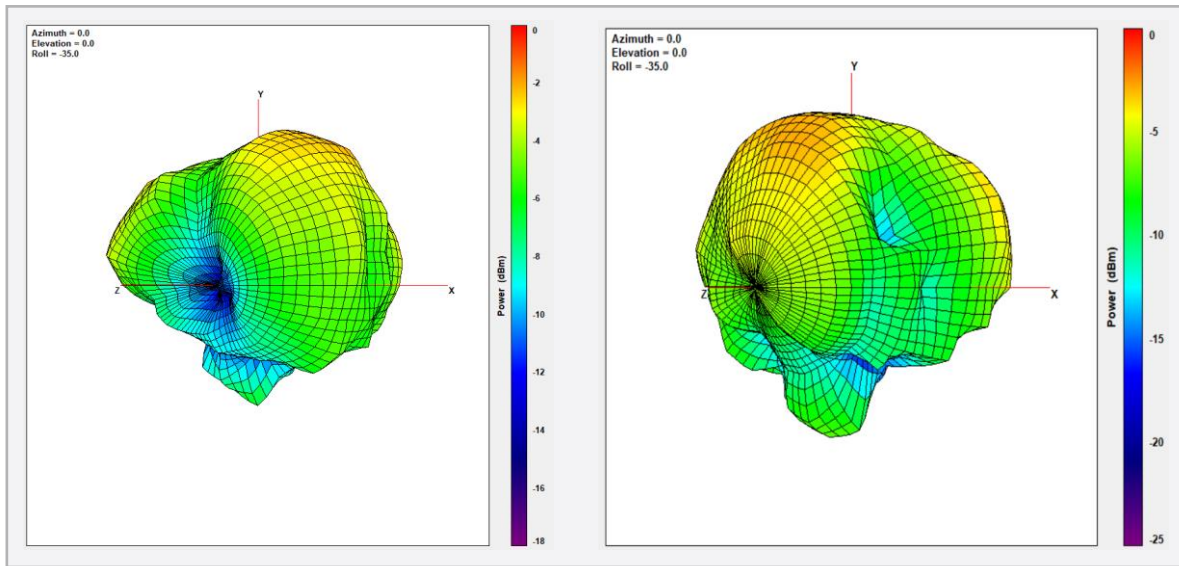

XY Plane

XZ Plane

YZ Plane

MIMO 1

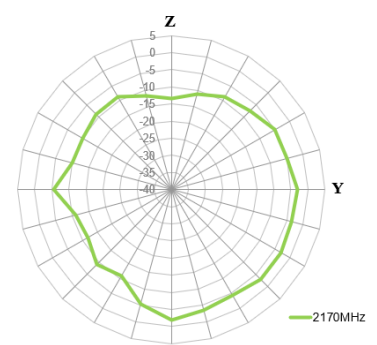
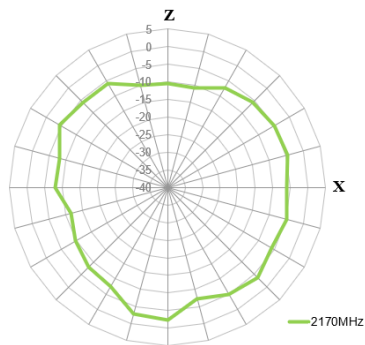
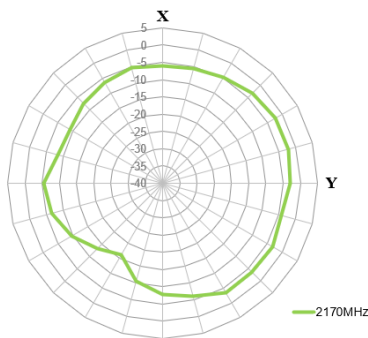

MIMO 2

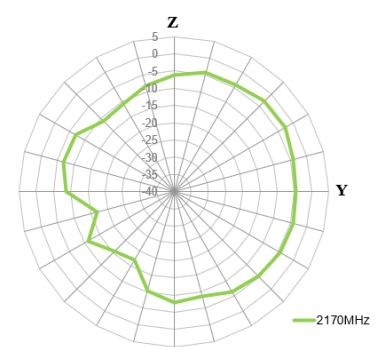
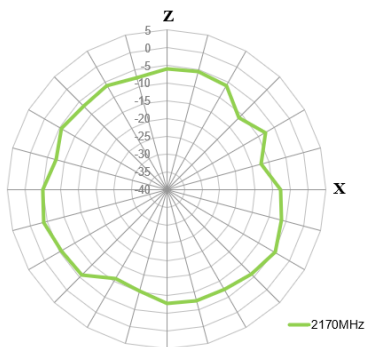
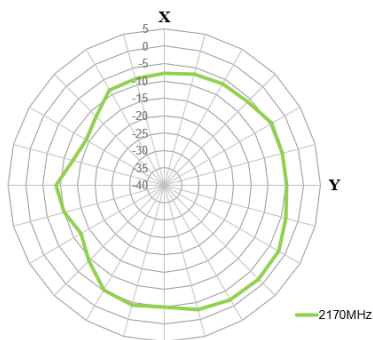

2690MHz

MIMO 1

MIMO 2

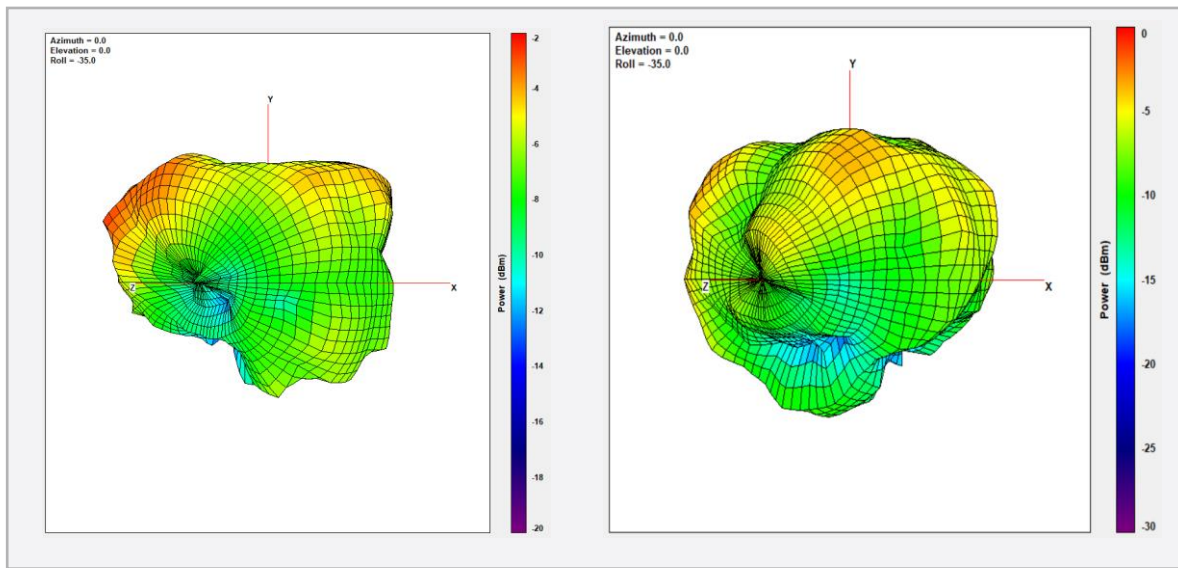

XY Plane

Z Plane

YZ Plane

MIMO 1

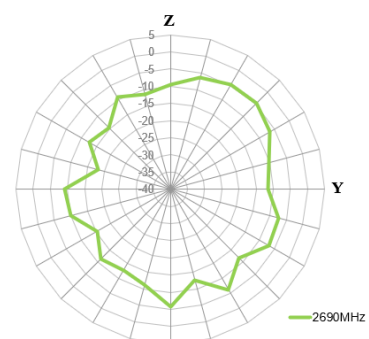
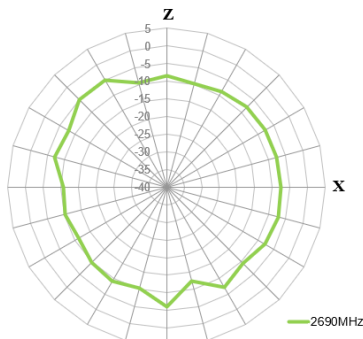
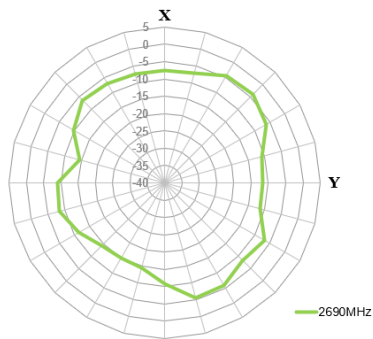

MIMO 2

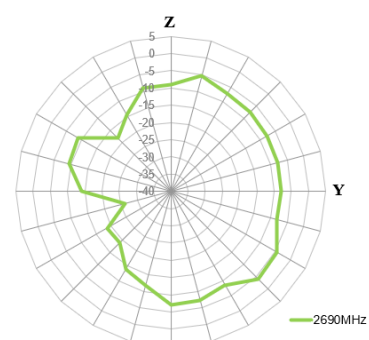
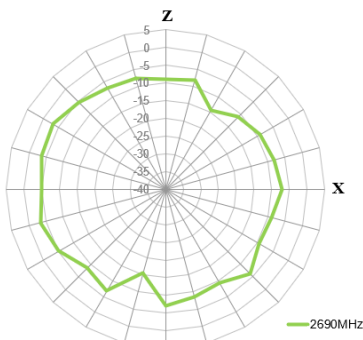
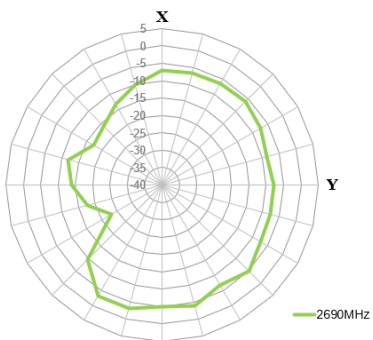

3200MHz

MIMO 1

MIMO 2

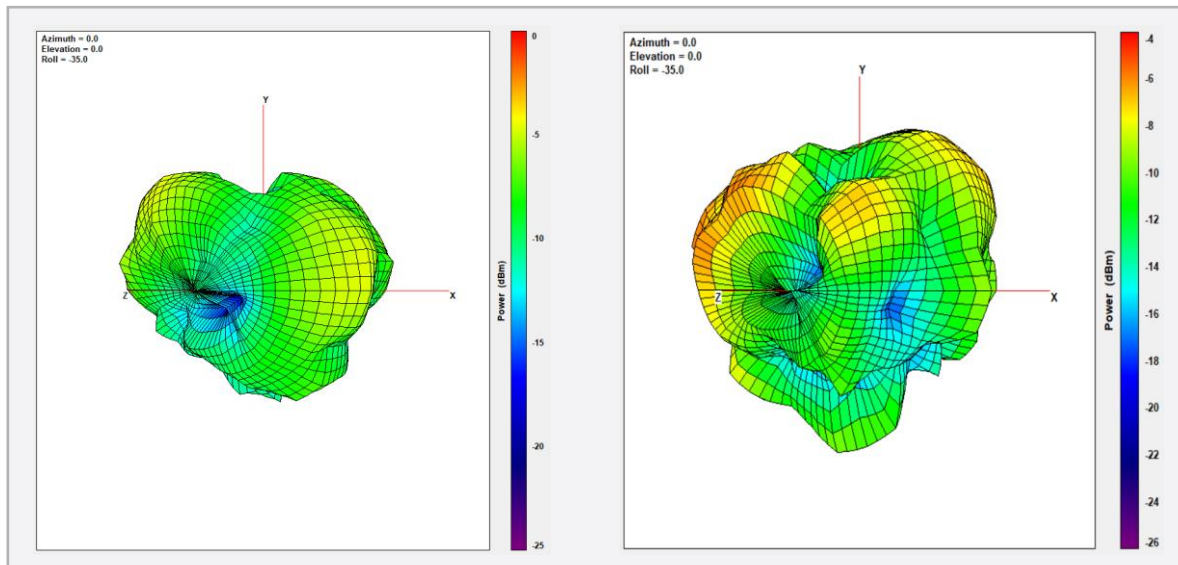

XY Plane

XZ Plane

YZ Plane

MIMO 1

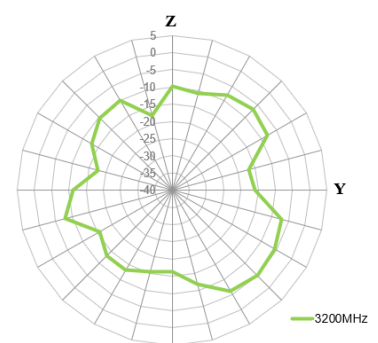
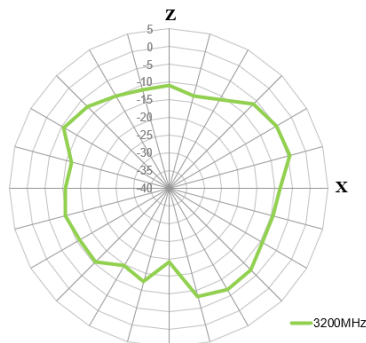
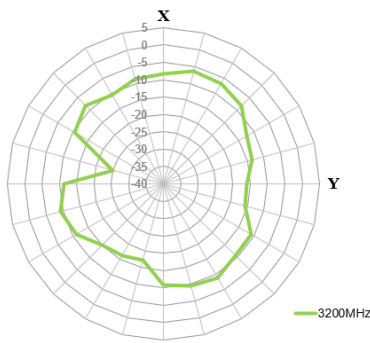

MIMO 2

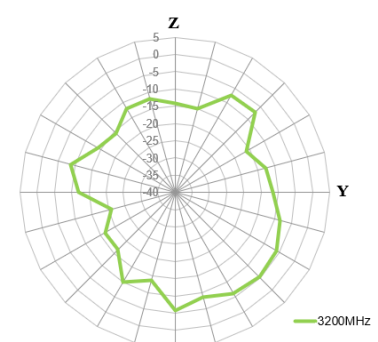
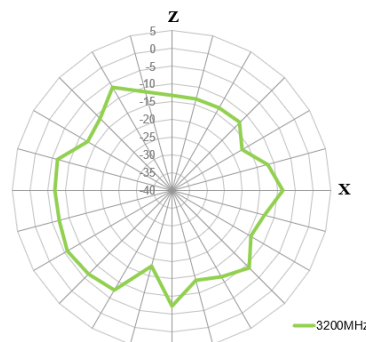
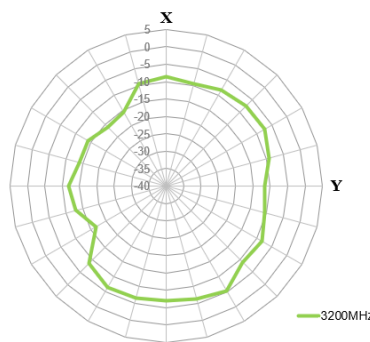

4200MHz

MIMO 1

MIMO 2

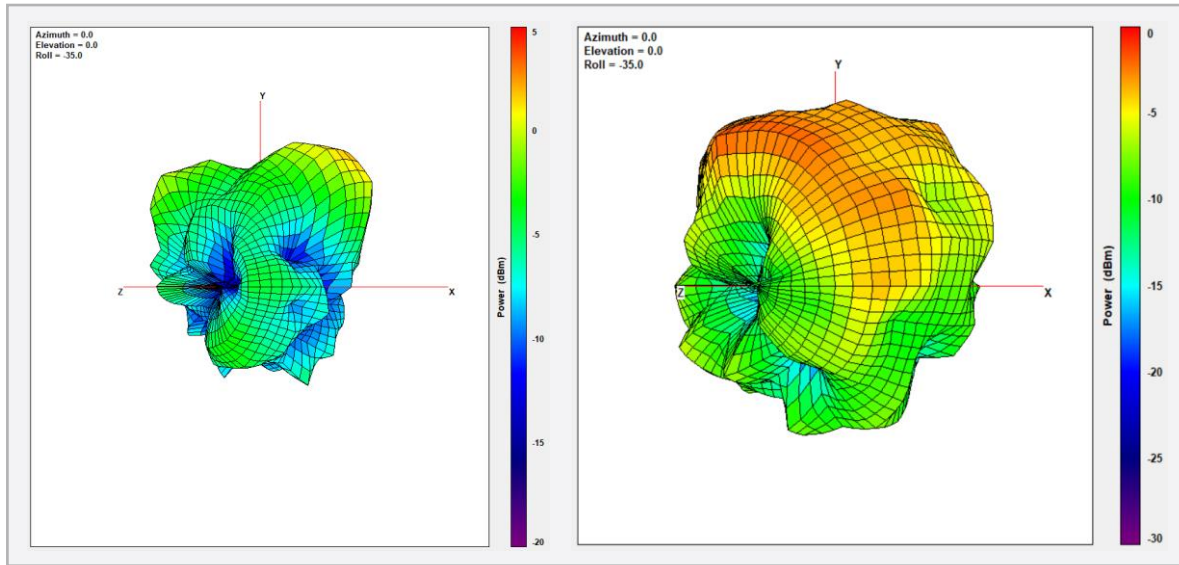

XY Plane

XZ Plane

YZ Plane

MIMO 1

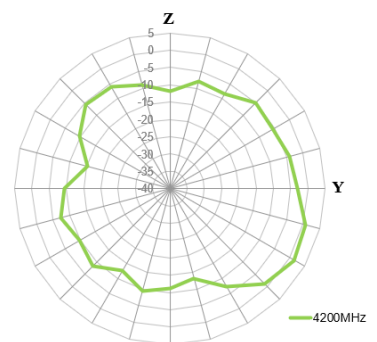
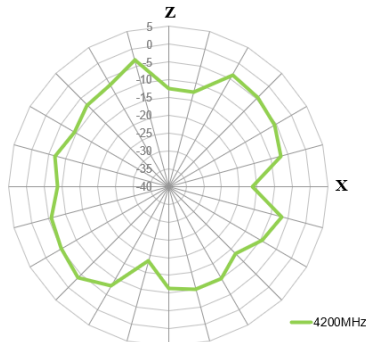
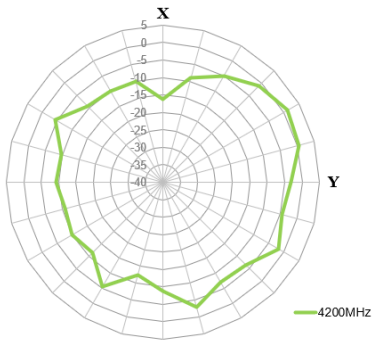

MIMO 2

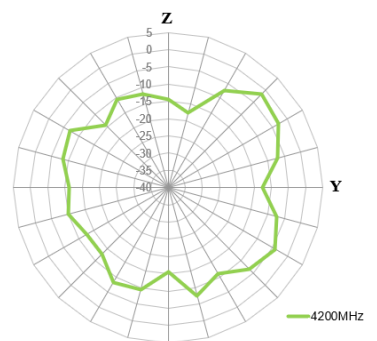
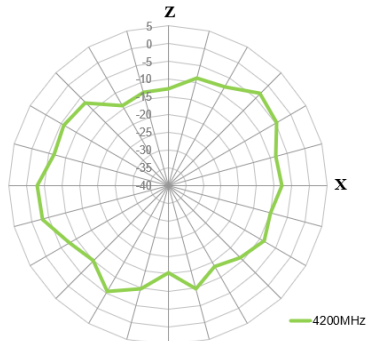
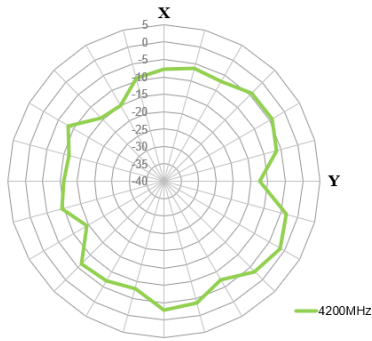

5150MHz

MIMO 1

MIMO 2

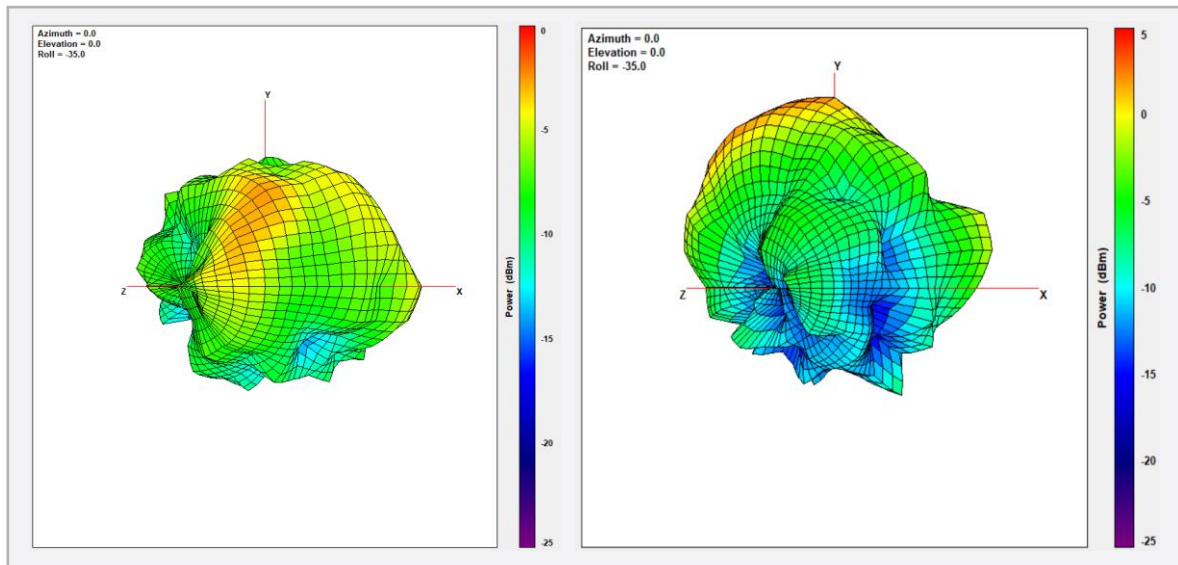

XY Plane

XZ Plane

YZ Plane

MIMO 1

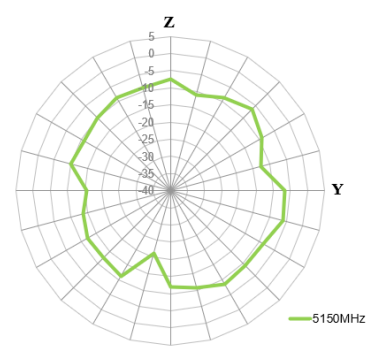
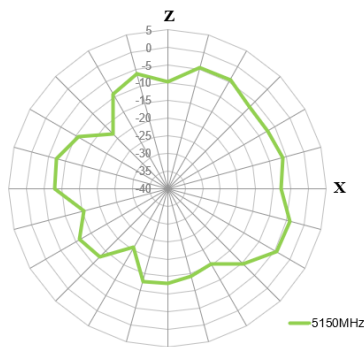
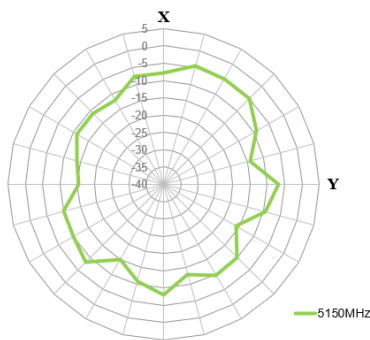

MIMO 2

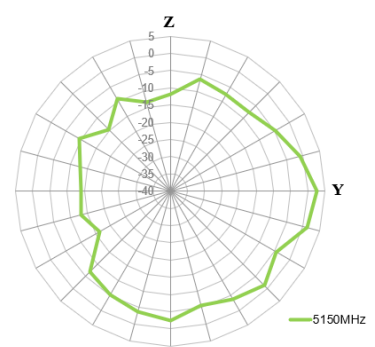
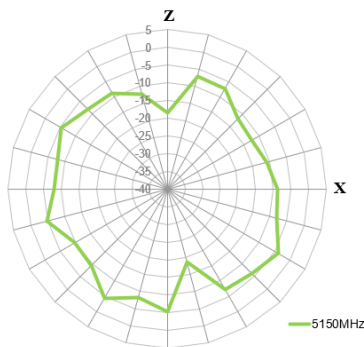
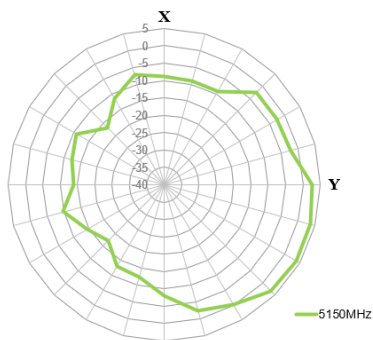

5550MHz

MIMO 1

MIMO 2

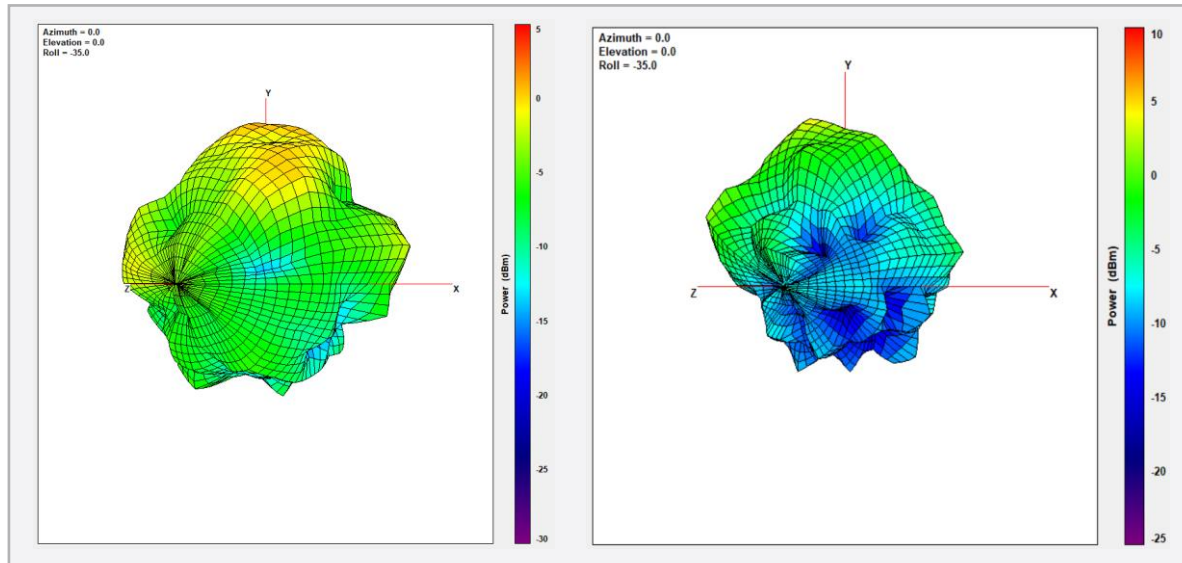

XY Plane

XZ Plane

YZ Plane

MIMO 1

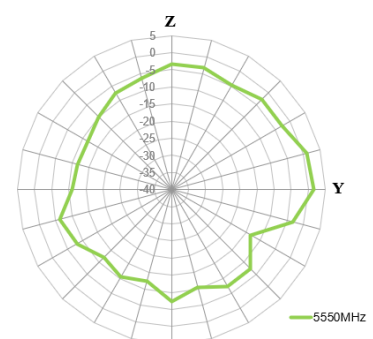
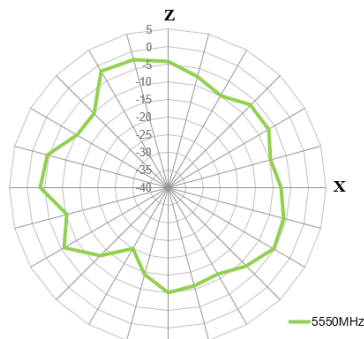
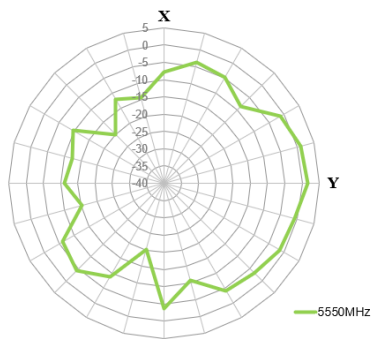

MIMO 2

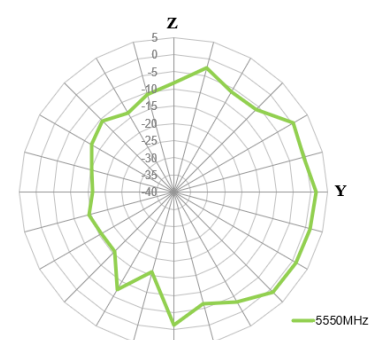
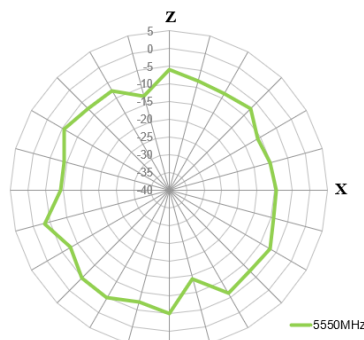
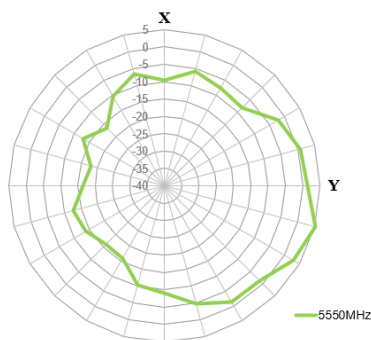

5.5GHz

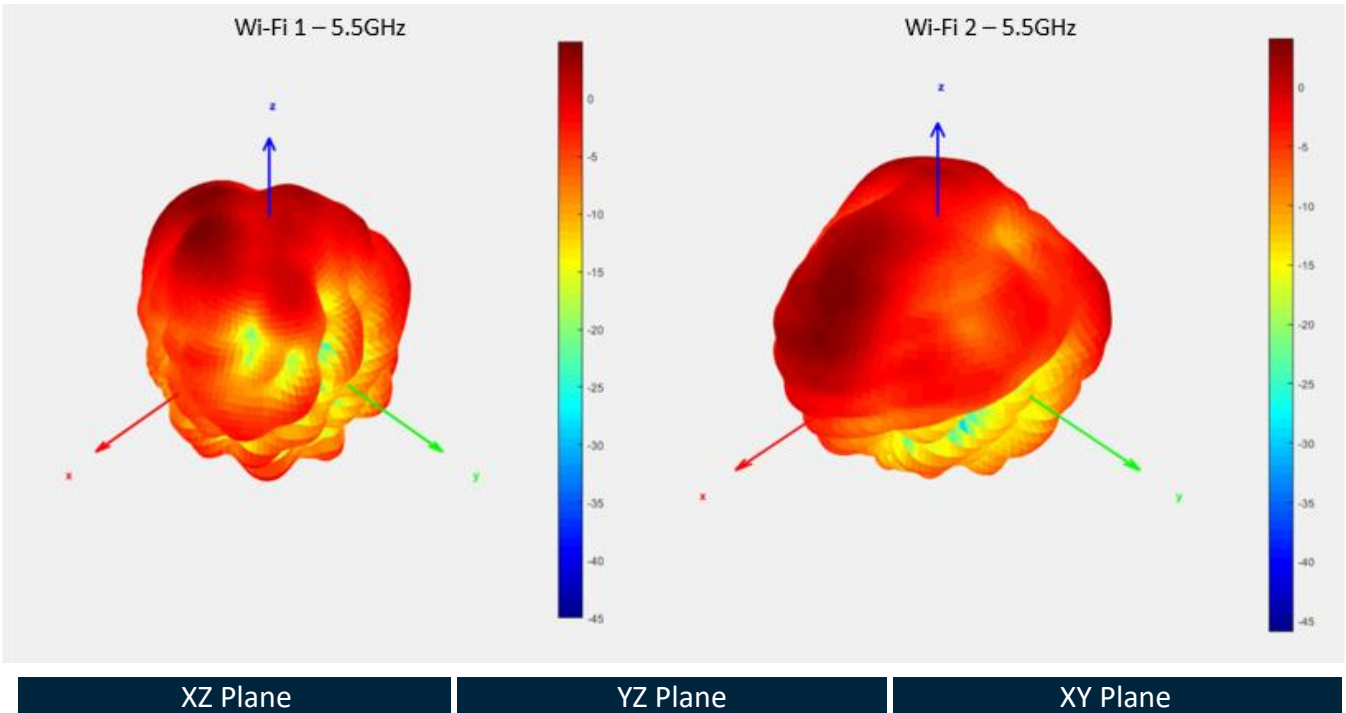

Wi-Fi 1

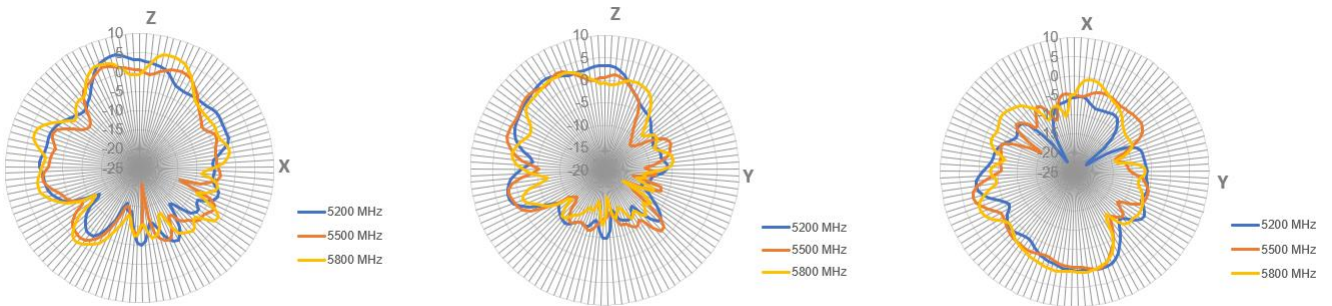

Wi-Fi 2

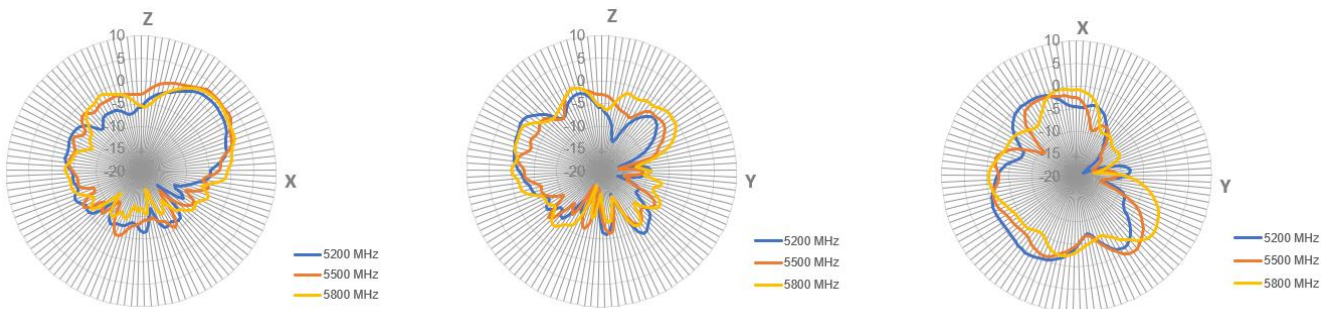

5.8GHz

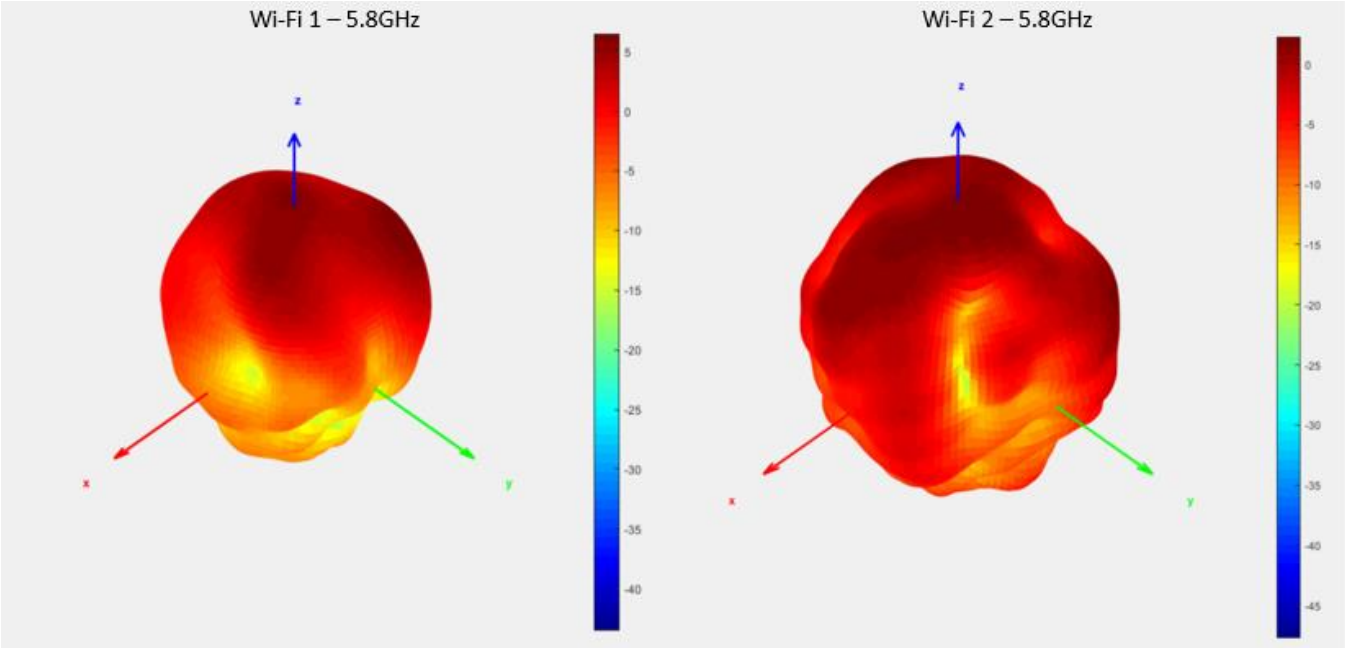

XZ Plane

YZ Plane

XY Plane

Wi-Fi 1

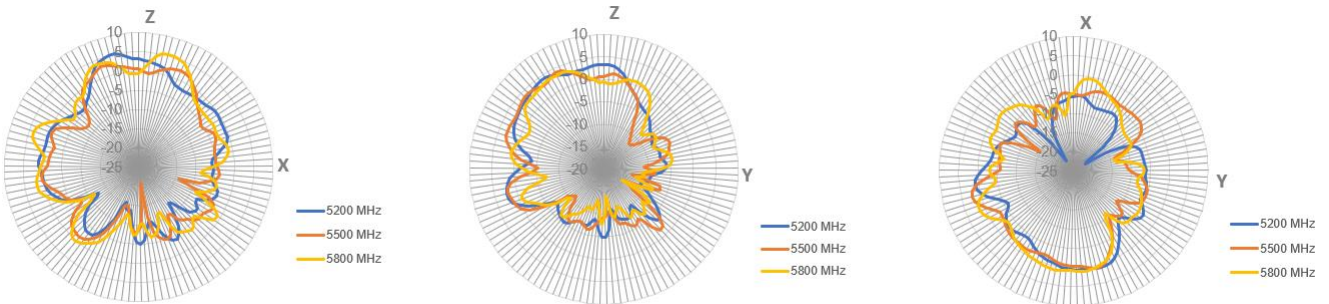

Wi-Fi 2

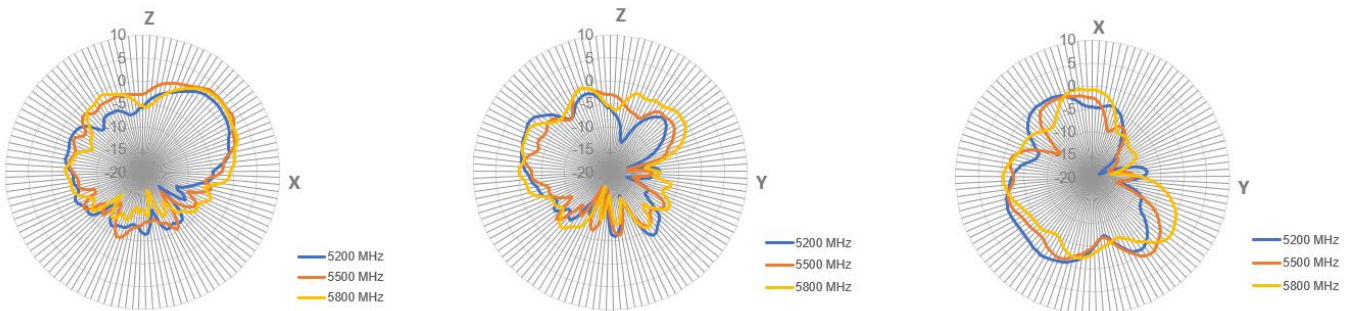

4.4 GNSS 3D and 2D Radiation Patterns

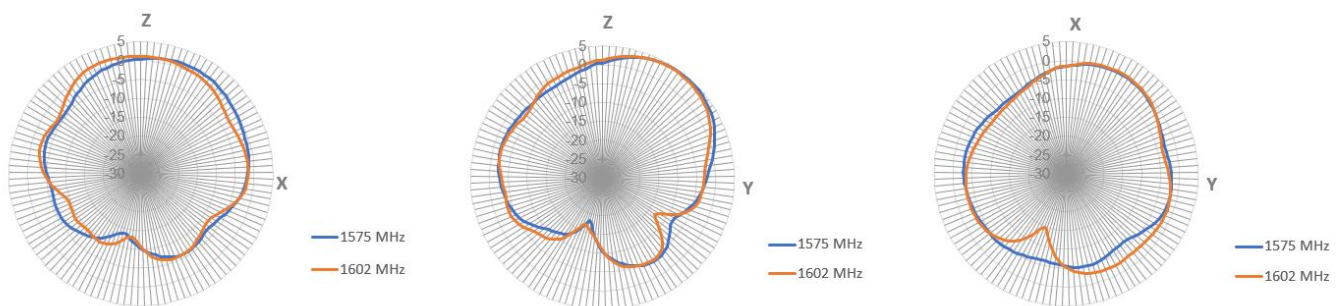
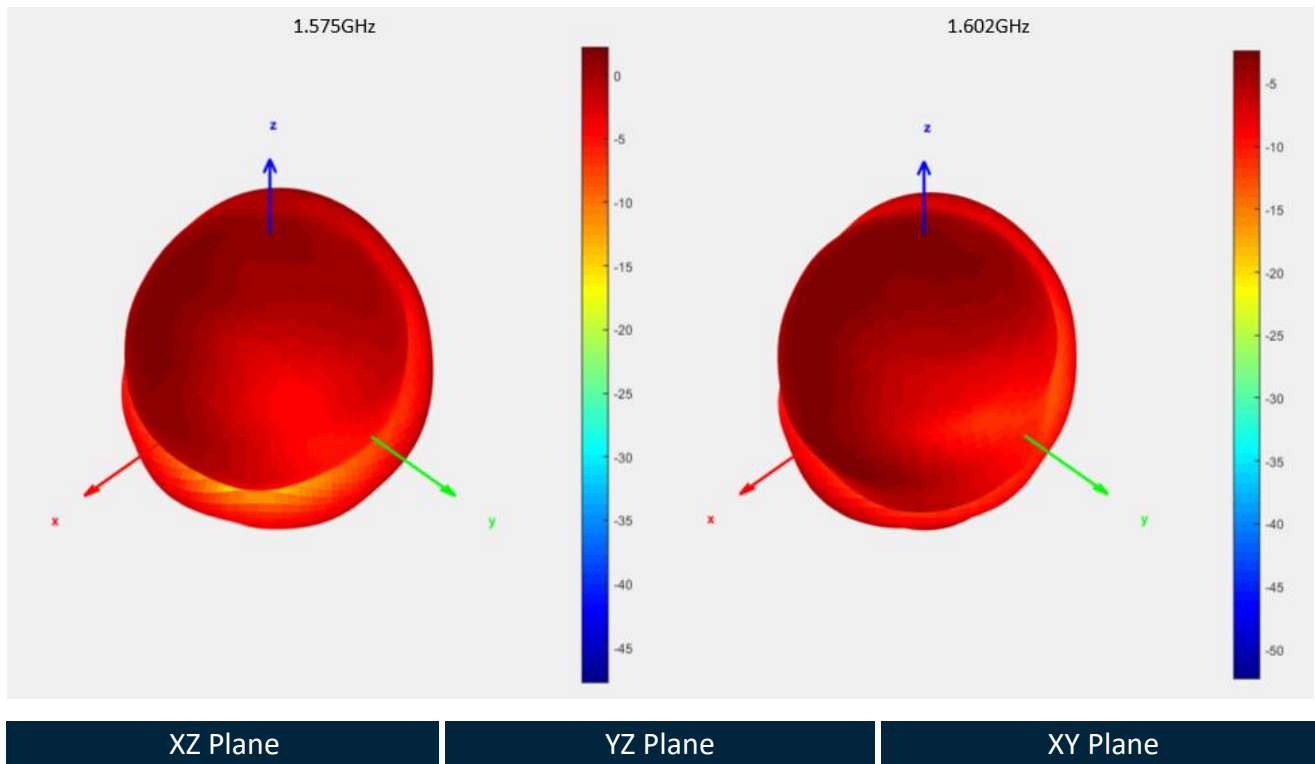

5. Mechanical Drawing

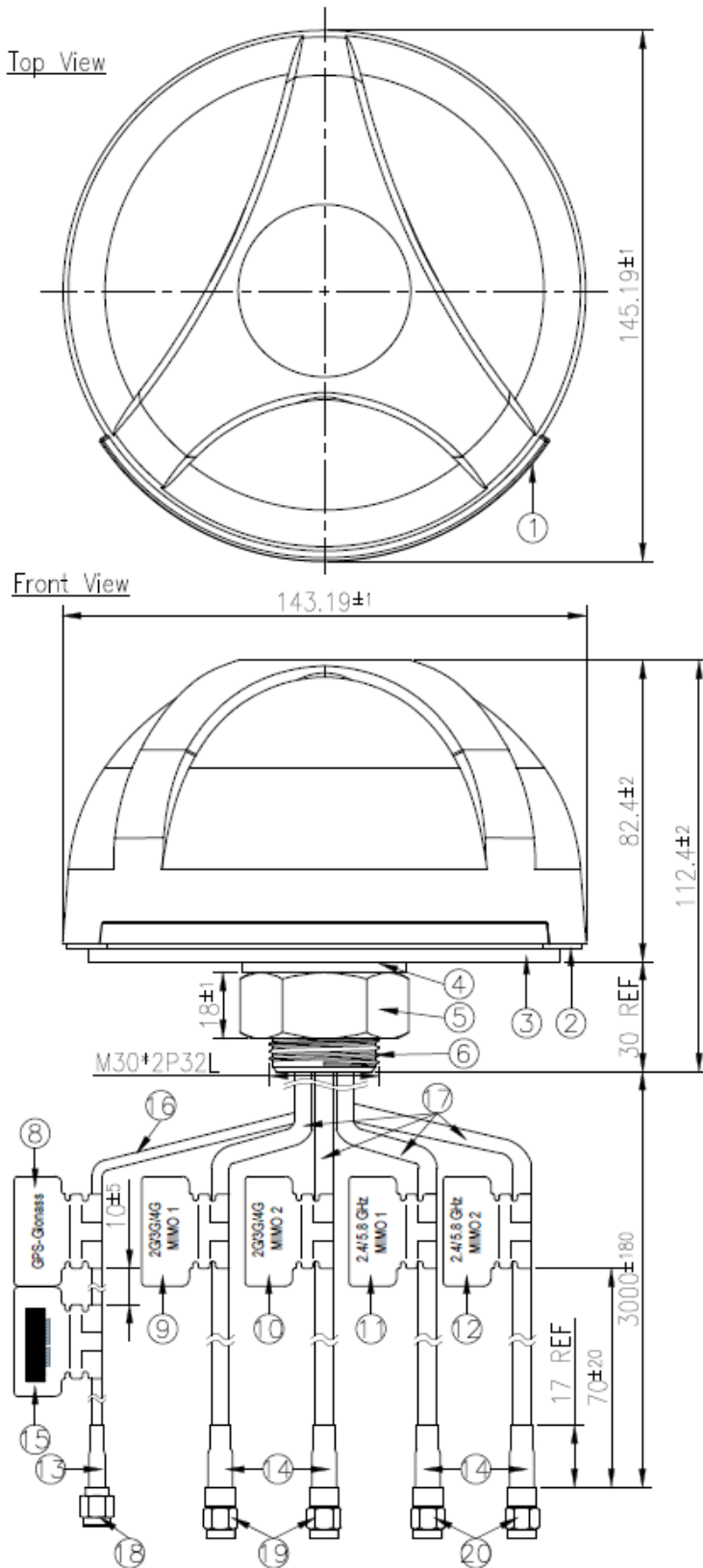

Bottom Thread View

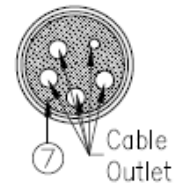

	Name	P/N	Material	Finish	QTY
1	Housing	000111000015A	ABS+PC	Black	1
2	Waterproof Rubber	000711F000015A	Silicone Rubber	Black	1
3	Double Sided Adhesive(Black Foam)	001011F030015A	3M4488+CR435	White Liner	1
4	Washer M30	000411F010015A	Steel	Ni Plated	1
5	M30 Nut	000411F000015A	Steel	Ni Plated	1
6	M30x2P Thread 32L	000311F000015A	Zinc Alloy	Ni Plated	1
7	Rubber Stepper	000711F010015A	Silicone Rubber	Black	1
8	GPS-Glonass Label	001012K010015A	PEPA	Orange	1
9	2G/3G/4G MIMO1 (48x30)	001012L060015A	PEPA	Gray	1
10	2G/3G/4G MIMO2 (48x30)	001012L090015A	PEPA	White	1
11	2.4/5.8 GHz MIMO1 Label	001016C040000A	PEPA	Yellow Black	1
12	2.4/5.8 GHz MIMO2 Label	001016C050000A	PEPA	Red	1
13	Heat Shrink Tube(RC174)	001315C020000A	PE	Black	1
14	Heat Shrink Tube(CF0200)	001315C030000A	PE	Black	4
15	Barcode Label	001013G000015A	PEPA	White	1
16	RC174 Coaxial Cable	301315C000000A	PVC	Black	1
17	CF0200 Coaxial Cable	301415C010000A	PE	Black	4
18	SMA(M)ST	200214000015A	Brass	Air Plated	1
19	SMA(M)ST	2002120010015A	Brass	Air Plated	2
20	RP-SMA(M)ST	200212F000015A	Brass	Air Plated	2

6. Installation

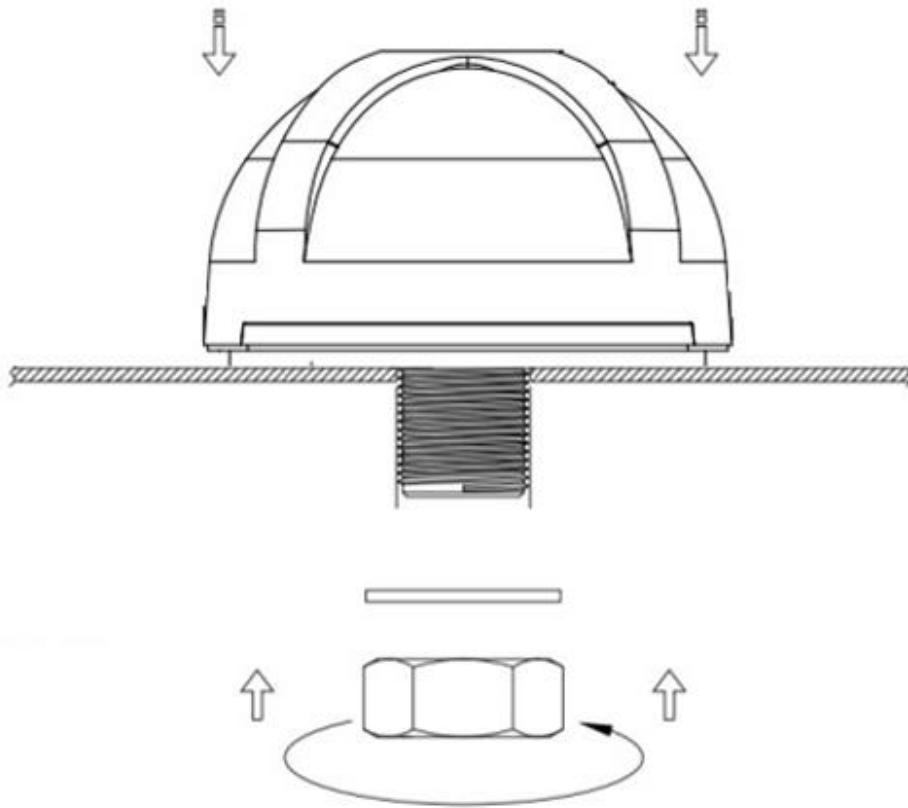

Recommended torque for mounting: 5-7Nm
(Torque value obtained with antenna mounted on 1mm thick SUS-316 bracket)

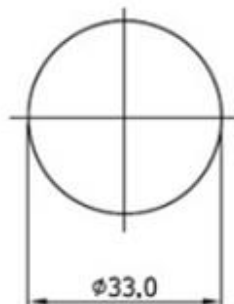

**Recommended
Mounting Hole**

Unit:mm

7. Packaging

1pc MA752.B.ABICG.001 per box
 Box Dimensions – 185 x 170 x 177mm
 Weight – 1.29kg

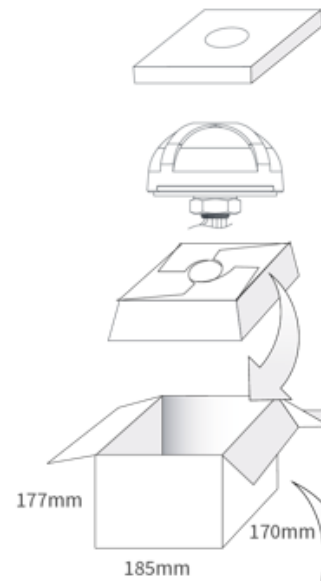

8pcs MA752.B.ABICG.001 per carton
 Carton Dimensions – 384 x 350 x 388mm
 Weight – 12.24kg

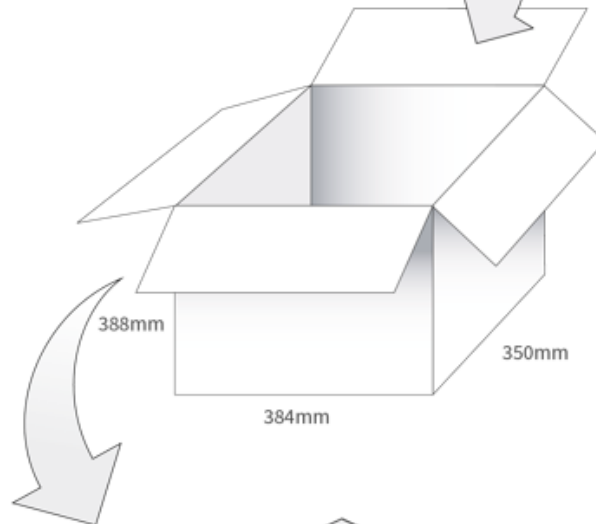

32 Cartons per pallet
 Pallet Dimensions – 1100 x 1100mm

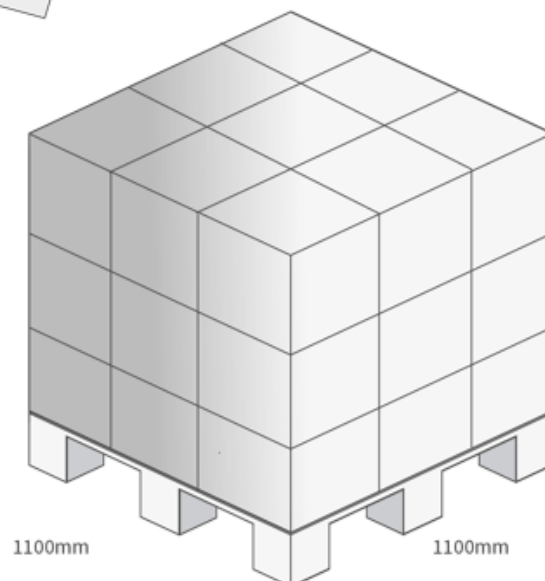

Changelog for the datasheet

SPE-17-8-039 – MA752.A.ABICG.001

Revision: B (Current Version)

Date:	2022-06-02
Changes:	Full datasheet update. New data covers up to 6GHz.
Changes Made by:	Gary West

Previous Revisions

Revision: A (Original First Release)

Date:	2017-09-08
Notes:	
Author:	Technical Writer



TAOGLAS®

www.taoglas.com

