

Key Features

**Up to 3 Watt
at 70°C**

**12:06, 20:10,
and 25:12
Packages
Available**

**Low
Inductance
<5nH**

**AEC-Q200
Qualified**

**Sulfur
Resistant -
unaffected by
sulfur
environments**

Type TLRP Series

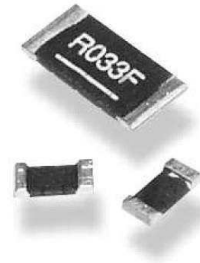

TE Connectivity (TE) is pleased to offer these unique AEC-Q200 qualified High Power Metal Strip Resistors for Current Sensing positions. TLRP resistors have a special metal resistive element combined with suitable barrier layers beneath the solder to prolong terminal life. This model is particularly useful for power management along with DC-DC converting and charging applications, as well as adaptors within SWPS applications.

Characteristics – Electrical

Size	Power Rating @ 70°C	Resistance Range (mΩ)			TCR (PPM/°C)
		±0.5%	±1%	±5%	
1206	1W	8, 10, 12, 15, 20, 25, 30, 33, 40,			±50
		3, 4, 5, 7, 8, 10, 12, 15, 18, 20, 22, 25, 30, 33, 40, 47, 51, 68, 75, 82, 90, 100, 150			±75 ±100
2010	1W	10, 15, 20, 30, 50, 68, 75, 100			±75
	2W	10, 15, 20, 30, 50			
2512	2W & 3W	3, 4, 5, 6, 7, 18, 20, 22, 25, 30, 33, 35, 39, 40, 47, 50, 60, 68, 70, 75, 80, 82, 90, 91, 100, 120, 150, 180, 200			±25
		1, 2, 3, 4, 5, 6, 7, 8, 9, 10, 12, 15, 18, 20, 22, 25, 27, 30, 33, 35, 39, 40, 47, 50, 51, 56, 60, 68, 70, 75, 80, 82, 90, 91, 100, 120, 150, 180, 200, 220			±50 ±75

Operating Temperature Range: -55 ~ 170°C

Operating Current = $\sqrt{P/R}$, Operating Voltage = $\sqrt{P \cdot R}$

Derating

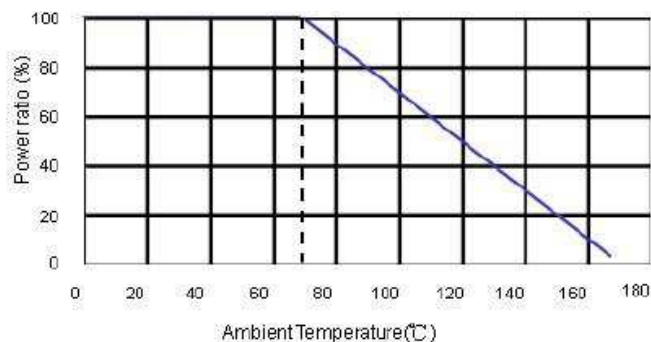

Construction and Dimensions

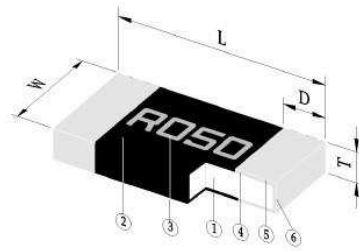

① Alloy Plate	④ Internal Electrode
② Overcoat	⑤ Barrier Layer
③ Marking	⑥ Solder Plating

Type	Size	L mm	W mm	T mm	D mm
TLRP2B	1206	3.15±0.10	1.45±0.10	0.55±0.10	0.55±0.15
TLRP2H	2010	5.00±0.10	2.40±0.15	0.60±0.10	0.80±0.20
TLRP3A	2512	6.40±0.25	3.20±0.25	0.70±0.20	0.90±0.30

Marking

Resistance (4 Digit)

Resistance	3mΩ	10mΩ	22mΩ	100mΩ
Codes	R003	R010	R022	R100

Solder Profile (Reflow)

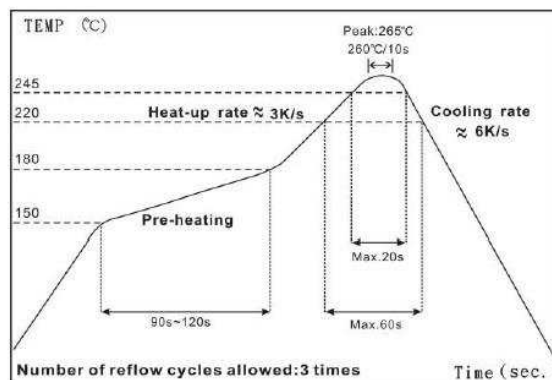

IR Reflow Soldering

(1) Time of IR reflow soldering at maximum temperature point 260°C : 10s

Environmental Characteristics

Item	Requirement	Test Method
Temperature Coefficient of Resistance (T.C.R.)	As Spec.	IEC60115-1 4.8 JIS-C-5201-1 4.8 +25°C ~125°C, 25°C is the reference temperature
Short Time Overload	±1.0%	IEC60115-1 4.13 JIS-C-5201-1 4.13 5*rated power for 5 seconds
Insulation Resistance	≥10G	IEC60115-1 4.6 JIS-C-5201-1 4.13 100V DC for 1 minute
Endurance	±1.0%	IEC60115-1 4.25 JIS-C-5201-1 4.25.1 70±2°C, rated power for 1000 hrs with 1.5 hrs "ON" and 0.5 hr "OFF" MIL-STD-202 Method 108 Condition D Steady State TA=125°C at derated power. Measurement at 24±4 hours after test conclusion.
Biased Humidity	±1.0%	MIL-STD-202 Method 103 1000 hrs 85°C/85%RH 10% of operating power
Dry Heat	±1.0%	IEC60115-1 4.23.2 JIS-C-5201-1 4.23.2 MIL-STD-202 Method 108 at +170°C for 1000 hrs
Resistance to Solvents	No visible damage on appearance and marking.	MIL-STD-202 Method 215 Note: Add Aqueous wash chemical - OKEM Clean or equivalent. Do not use banned solvents.
Mechanical Shock	±1.0%	MIL-STD-202 Method 213 Wave Form: Tolerance for half sine shock pulse. Peak value is 100g's. Normal duration(D) is 6.
Vibration	±1.0%	MIL-STD-202 Method 204 5g's for 20 min., 12 cycles each of 3 orientations. Note: Use 8"X5" PCB .031" thick 7 secure points on one long side and 2 secure points at corners of opposite sides. Parts mounted within 2" from any secure point. Test from 10-2000 Hz.
ESD	±1.0%	AEC-Q200-002 Human body model, 2KV. (DC = Direct Contact Discharge)
Flammability	V-0	UL-94 50W (20 mm) Vertical Burning Test. Electrical test not required.

Item	Requirement	Test Method
Flame Retardance	The following phenomena cannot occur during the experiment: (1)A flame over 3.0 seconds duration. (2)An explosion. (3)A temperature above 350°C sustained for over 10 seconds	AEC-Q200-001 Assemble the sample on the test board, perform functional test before flame retardant test to ensure no damage to the sample. The test environment is 22±5 °C still air, from 9.0 to 32.0 VDC (current clamped up to 500A), increase the voltages at the rate of 1.0 VDC per hour until the end of the experiment.
Bending Strength	±1.0%	JIS-C-5201-1 4.33 IEC-60115-1 4.33 AEC-Q200-005 Bending width 2mm once for 5 seconds
Terminal Strength (SMD)	Not broken	AEC-Q200-006 Force of 1.8kg for 60 seconds.
Solderability	95% min. coverage	JIS-C-5201-1 4.17 IEC-60115-1 4.17 J-STD-002 245±5°C for 3seconds
Resistance to Soldering Heat	±0.5%	JIS-C-5201-1 4.18 IEC-60115-1 4.18 MIL-STD-202 Method 210 260±5°C for 10 seconds
Rapid Change of Temperature	±1.0%	JIS-C-5201-1 4.19 IEC-60115-1 4.19 -55°C to +155°C, 5 cycles
Temperature Cycling	±1.0%	JESD22 Method JA-104 1000 cycles (-55°C to +125°C, Dwell 30 minutes, transition time within 1 minute). Measurement at 24±4 hours after test conclusion.
Low Temperature Storage	±1.0%	IEC60115-1 4.23.4 JIS-C-5201-1 4.23.4 at -55°C for 2hrs

RCWV (Rated Continuous Working Voltage)= $\sqrt{P \cdot R}$ or Max. Operating Voltage whichever is lower.

Storage Temperature: 15~28°C; Humidity < 80%RH

Recommended Land Pattern

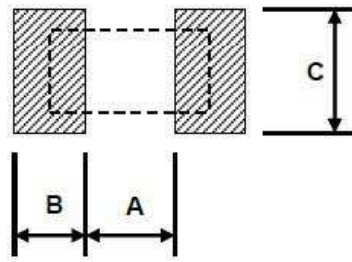

Size	A (mm)	B (mm)	C (mm)
1206	1.50	1.40	1.70
2010	3.60	1.40	2.50±0.2
2512	4.00	2.00	3.50

*FR4 copper board, 100µm of copperpad thickness

Packaging

Reel Specifications & Packaging Quantity

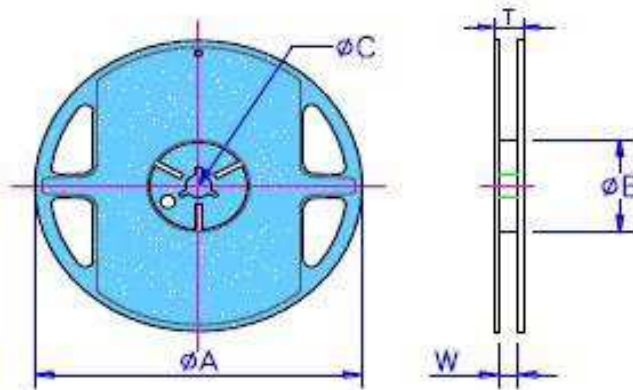

Size	Resistance (mΩ)	Tape / Qty	Tape width	Reel Dia.	ØA (mm) ±1.5	ØB (mm)	ØC (mm)	W (mm)	T (mm)
1206	3~40	Paper / 5K	8mm	7 inch	178.5	60 ⁺¹⁻⁰	13.0 ±0.2	9.0±0.5	12.5 ±0.5
2010	10~100	Embossed / 4K	12mm			60 ⁺¹⁻⁰	13.0 ±0.5	13.0 ±0.5	15.5 ±0.5
2512	4~200	Embossed / 4K	12mm			60±1.0	13.0 ±0.5	13.0±1.0	15.5 ±0.5
2512	3	Embossed / 2K	12mm						

Paper Tape Specification

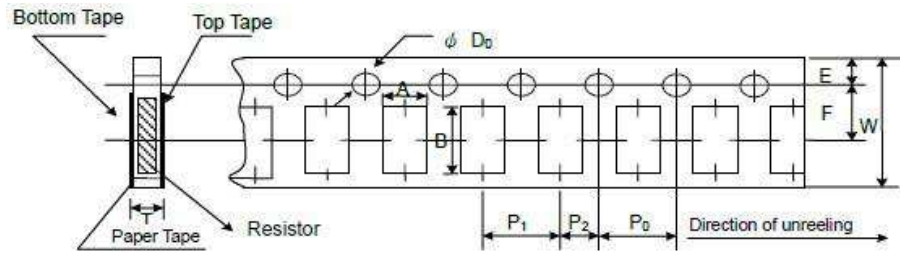

A (mm)	B (mm)	W (mm)	E (mm)	F (mm)	P ₀ (mm)	P ₁ (mm)	P ₂ (mm)	∅D ₀ (mm)	T (mm)
1.90±0.10	3.50±0.20	8.0±0.20	1.75±0.10	3.50±0.05	4.00±0.10	4.00±0.05	2.00±0.05	1.50+0.1,-0	0.85±0.10

Embossed Plastic Tape Specification

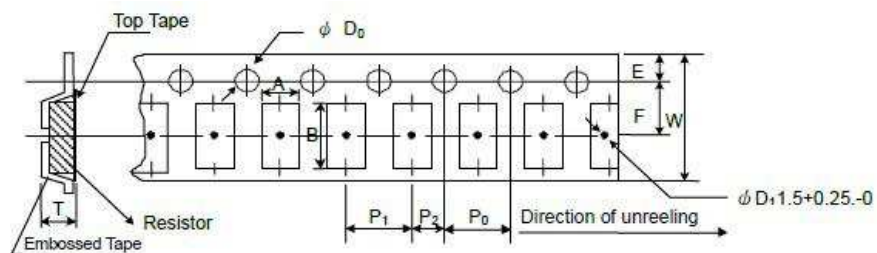

	A (mm)	B (mm)	W (mm)	E (mm)	F (mm)	P ₀ (mm)	P ₁ (mm)	P ₂ (mm)	∅D ₀ (mm)	T (mm)
2010	2.80±0.10	5.5±0.10	12.0±0.30	0.75±0.10	5.5±0.5	4.00±0.10	4.00±0.10	2.00±0.05	1.5+0.1-0	1.20+0
2512	3.50±0.10	6.70±0.10	12.0±0.30	1.75±0.10	5.5±0.05	4.00±0.10	4.00±0.10	2.00±0.05	1.50+0.1-0	1.20+0
2512 3mΩ										1.45±0.2

How To Order

TLRP	2B	10	E	R008	F	TD
Common Part	Size	*Power Rating	**TCR (PPM/°C)	Resistance Code	Tolerance	Packaging
TLRP – Ultra Low Ohm Metal Strip Resistor	2B – 1206 2H - 2010 3A – 2512	1.0 = 10 2.0 = 20 3.0 = 30	C = ±25 D = ±50 W = ±75 E = ±100	R003 - 3mΩ R020 - 20mΩ R10 – 0.1Ω (100mΩ)	D = ±0.5% F = ±1% J = ±5%	TDG = 2000/Reel (2512 3mΩ) TE = 4000/Reel (2512) TD = 5000/Reel (1206)