

Luminus UV-C High Power Starboards

Industry Leading High Powered LED Starboards

Data Sheet

Version 1.1

Lean & Fast. Made Smarter.

Superior Performance - Stay current with the highest intensity LEDs

Design Faster - Use industry standard starboards to shorten development time

Maximum Flexibility - Design to your exact specifications using NewEnergy starboards

Rapid Innovation - Work with NewEnergy on your custom solution

Primary Applications



Surface Sterilization
 Water Disinfection
 Air Purification
 Skin Therapy
 Florescence Analyzer
 Food Preparation
 Horticulture

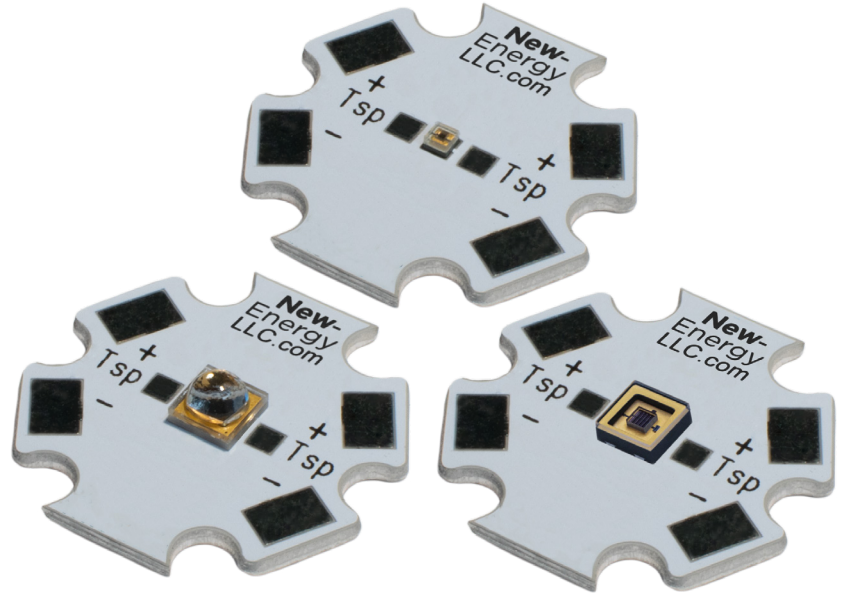

Custom Solutions

NewEnergy operates facilities globally with ISO certifications for the LED lighting, automotive and medical industries. Our North Carolina based office provides quick engineering & sales support with a R&D lab for prototype development and custom solutions. Our in-house global manufacturing capabilities allow for both building in the United States as well as overseas at scale.

About NewEnergy

NewEnergy accelerates the adoption of LED technology through simple, modular products and custom designs. Through 30 years of experience, state of the art manufacturing, full traceability and advanced quality controls, NewEnergy offers leading solid state lighting components, modules and custom solutions. NewEnergy customers get to market faster, with less resources, at lower costs. Visit new-energyllc.com for more information.

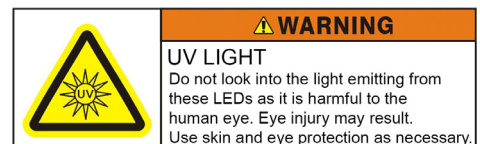
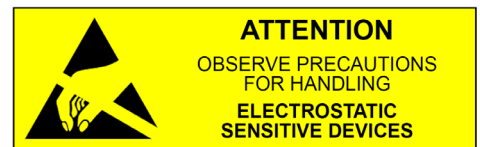

Luminus High Power Starboards

Product Selection Table

Part Number	LED Series	Beam Angle (°)	Color	Typical Wavelength Range	Typical Flux (mW)	Typical Forward Voltage (Vf)	Typical Watts (W)
LST1-01G06-UV02-01 ⁽¹⁾	XBT-1313	150	UV	270-275nm	2	6.5	0.26
LST1-01G07-UV01-01 ⁽²⁾	XST-3535	60	UV	275-286nm	35	6.45	2.26
LST1-01G08-UV01-01 ⁽²⁾	XBT-3535	130	UV	275-280nm	30	6.5	2.28
LST1-01G08-UV02-01 ⁽²⁾	XBT-3535	130	UV	280-285nm	30	6.5	2.28
LST1-01G08-UV03-01 ⁽²⁾	XBT-3535	130	UV	275-285nm	30	6.5	2.28
LST1-01G08-UV04-01 ⁽²⁾	XBT-3535	130	UV	275-280nm	35	6.5	2.28
LST1-01G08-UV05-01 ⁽²⁾	XBT-3535	130	UV	280-285nm	35	6.5	2.28
LST1-01G08-UV06-01 ⁽²⁾	XBT-3535	130	UV	275-285nm	35	6.5	2.28

⁽¹⁾Flux, wavelength, and wattage values specified at 40mA, Tj 25°C

⁽²⁾Flux, wavelength, and wattage values specified at 350mA, Tj 25°C

All values shown above are typical.

Do not look into the light that is emitting from these LEDs as it is harmful to the human eye.

Eye injury may result. Use skin and eye protection as necessary.

Maximum Ratings

Part Number	DC Current (mA)	Forward Voltage (V)	Tsp Temp (°C)	Power (W)
LST1-01G06-x	100	7.0	105	0.70
LST1-01G07-x	500	7.5	105	3.75
LST1-01G08-x	800	7.5	105	6.0

Luminus High Power Starboards

Dimensions (Units: Inches)

LST1-01G06-x

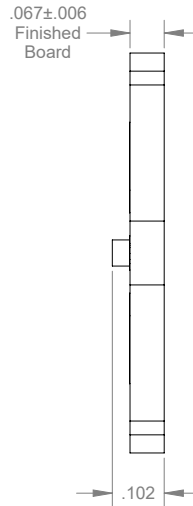
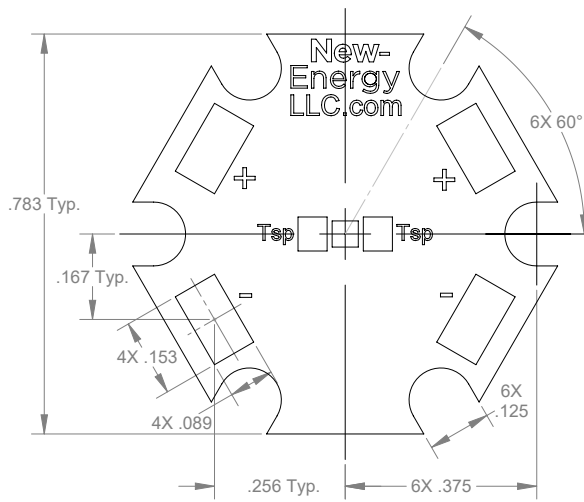

LST1-01G07-x

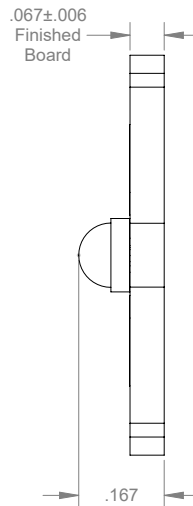
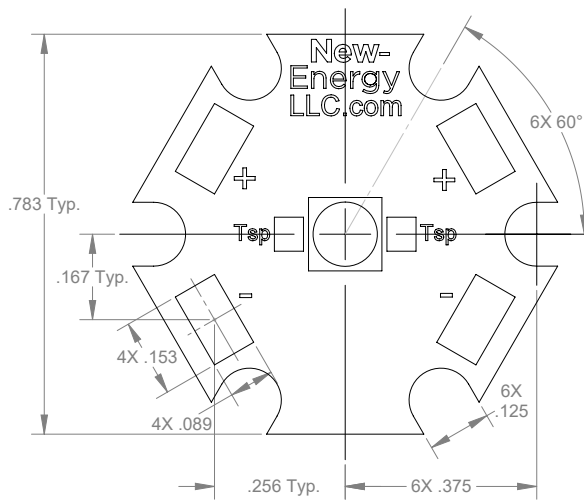

LST1-01G08-x

