

Customer Part:

Description

- Temperature compensated voltage controlled crystal oscillator (TCVCXO)
- 8 pad version
- Model IQXT-200-3-B
- Model Issue number 1

Frequency Parameters

- Frequency 10.0MHz
- Frequency Tolerance $\pm 0.50\text{ppm}$
- Tolerance Condition @ 25°C, 3.3V & VC=1.65V
- Frequency Stability $\pm 0.28\text{ppm}$
- Operating Temperature Range -20.00 to 70.00°C
- Ageing $\pm 0.02\text{ppm}$ max per day,
 $\pm 1.0\text{ppm}$ max per year
- Frequency Tolerance (measurement referenced to frequency observed with TA=25°C, Vs=3.3V, VC=1.65V and within 30 days after ex-works): $\pm 0.5\text{ppm}$
- Frequency Stability: TA varied over temperature, measurement referenced to frequency observed with TA=25°C, Vs=3.3V, VC=1.65V, load=15pF and temperature variable speed less than 2°C per minute.
- Ageing: TA=25°C, Vs=3.3V, VC=1.65V and after 1hr of operation.
- Supply Voltage Variation (measurement referenced to frequency observed with TA=25°C, Vs varied from 3.13V to 3.47V, VC=1.65V and load=15pF): $\pm 0.1\text{ppm}$ max
- Load Variation (5% load change measurement referenced to frequency observed with TA=25°C, Vs=3.3V, VC=1.65V and load=15pF): $\pm 0.1\text{ppm}$ max
- Short Term Stability (@ 25°C after 10mins power on): 5E-10/s typ @ 10MHz

Electrical Parameters

- Supply Voltage 3.3V $\pm 5\%$
- Current Draw 10.000mA
- Current: TA=25°C, Vs=3.3V, VC=1.65V and load=15pF

Frequency Adjustment

- Pulling $\pm 10\text{ppm}$ to $\pm 15\text{ppm}$
- Control Voltage 1.65V $\pm 1.65\text{V}$
- Linearity: $\pm 10\%$ max
- Slope: Positive
- Input Impedance: 100k Ω min

Output Details

- Output Compatibility HCMOS
- Drive Capability 15pF
- Rise and Fall Time 8.0ns max
- Duty Cycle 45/55%
- Output Low (@ Vs=3.3V, load=15pF): 0.4V max
- Output High (@ Vs=3.3V, load=15pF): 2.4V min

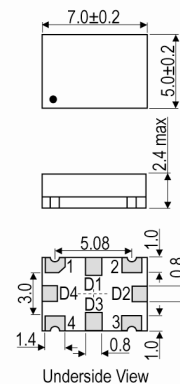
Outline (mm)

Pad Connections

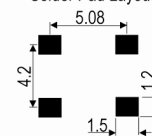
1. Voltage Control
 2. GND
 3. Output
 4. +Vs
- D1, D2, D3, D4. N/C

Solder Pad Layout

Sales Office Contact Details:

UK: +44 (0)1460 270200
Germany: 0800 1808 443

France: 0800 901 383
USA: +1.760.318.2824

Email: info@iqdfrequencyproducts.com
Web: www.iqdfrequencyproducts.com

Customer Part:

Noise Parameters

- Phase Noise (@ 10MHz typ):
 - 90dBc/Hz @ 10Hz
 - 115dBc/Hz @ 100Hz
 - 135dBc/Hz @ 1kHz
 - 145dBc/Hz @ 10kHz
 - 148dBc/Hz @ 100kHz
 - 150dBc/Hz @ 1MHz

Environmental Parameters

- Storage Temperature Range: -55 to 105°C
- ESD Level:
 - HBM, Class 2: 2000V to 4000V, JEDEC JS-001-2010
 - Machine Model, Class B: 200V to 400V, JEDEC JS-001-2010
- Shock: IEC 60068-2-27, Test Ea: 100G acceleration for 6ms, sinewave, in 3 mutually perpendicular planes
- Vibration: IEC 60068-2-6, Test Fc: 10Hz-2000Hz, 0.75mm amplitude, 10G acceleration, 30mins per cycle, in 3 mutually perpendicular planes, test duration 2hrs

Manufacturing Details

- Moisture Sensitivity Level: 2
- Maximum Reflow Temperature: 260°C (30secs max)

Compliance

- RoHS Status (2015/863/EU) Compliant
- REACH Status Compliant
- MSL Rating (JDEC-STD-033): 2

Packaging Details

- Pack Style: Bulk Loose in bulk pack
Pack Size: 1
- *Alternative packing option available*

Outline (mm) -B = 8 pad version

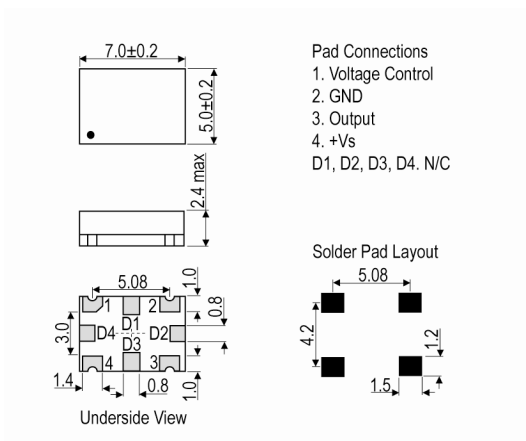

Sales Office Contact Details:

UK: +44 (0)1460 270200
Germany: 0800 1808 443

France: 0800 901 383
USA: +1.760.318.2824

Email: info@iqdfrequencyproducts.com
Web: www.iqdfrequencyproducts.com