



**SERIES:** PQME3-M | **DESCRIPTION:** DC-DC CONVERTER

**FEATURES**

- up to 3 W continuous power
- 14 pin SMT package
- 4:1 input range
- single regulated output
- -40 to +85°C temperature range
- efficiency up to 84%
- no load power consumption under 0.1 W



MODEL	input voltage		output voltage (Vdc)	output current		output power max (W)	ripple & noise <sup>3</sup> max (mVp-p)	efficiency <sup>4</sup> typ (%)
	typ (Vdc)	range (Vdc)		min (mA)	max (mA)			
PQME3-D24-S3-M	24	9~36	3.3	0	728	2.4	120	75
PQME3-D24-S5-M <sup>1, 2</sup>	24	9~36	5	0	600	3	120	80
PQME3-D24-S9-M	24	9~36	9	0	333	3	120	80
PQME3-D24-S12-M <sup>1, 2</sup>	24	9~36	12	0	250	3	120	82
PQME3-D24-S15-M <sup>1, 2</sup>	24	9~36	15	0	200	3	120	83
PQME3-D24-S24-M <sup>1, 2</sup>	24	9~36	24	0	125	3	120	82
PQME3-D48-S3-M <sup>2</sup>	48	18~75	3.3	0	728	2.4	120	75
PQME3-D48-S5-M <sup>2</sup>	48	18~75	5	0	600	3	120	79
PQME3-D48-S12-M <sup>2</sup>	48	18~75	12	0	250	3	120	82
PQME3-D48-S15-M <sup>2</sup>	48	18~75	15	0	200	3	120	84
PQME3-D48-S24-M <sup>2</sup>	48	18~75	24	0	125	3	120	82

- Notes:
1. UL certified
  2. CE certified
  3. From 5~100% load, nominal input, 20 MHz bandwidth oscilloscope, with 10 µF tantalum and 1 µF ceramic capacitors on the output. From 0~5% load, ripple and noise is <5% Vo.
  4. Measured at nominal input voltage, full load.
  5. All specifications are measured at Ta=25°C, humidity < 75%, nominal input voltage, and rated output load unless otherwise specified.

**PART NUMBER KEY**

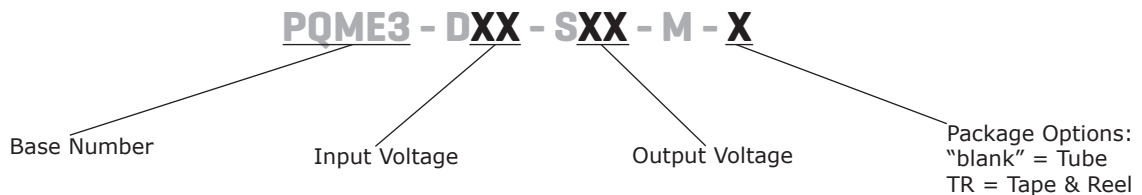

## INPUT

parameter	conditions/description	min	typ	max	units
operating input voltage	24 Vdc input models	9	24	36	Vdc
	48 Vdc input models	18	48	75	Vdc
start-up voltage	24 Vdc input models	9			Vdc
	48 Vdc input models	18			Vdc
surge voltage	for maximum of 1 second				
	24 Vdc input models	-0.7		50	Vdc
under voltage shutdown	48 Vdc input models	-0.7		100	Vdc
	24 Vdc input models	5.5	6.5		Vdc
current	48 Vdc input models	13	15.5		Vdc
	24 Vdc input models			138	mA
remote on/off (CTRL) <sup>1</sup>	3.3 Vdc output models			161	mA
	all other models			69	mA
filter	48 Vdc input models			82	mA
	3.3 Vdc output models				
no load power consumption	all other models				
	turn on (control pin floating or connected to TTL high level 3.5~12 Vdc)				
input current when switched off	turn off (control pin connected to GND or low level 0~1.2 Vdc)				
			6	10	mA
filter	C type				
no load power consumption				0.1	W

Note: 1. The voltage of the CTRL pin is referenced to GND.

## OUTPUT

parameter	conditions/description	min	typ	max	units
maximum capacitive load	3.3, 5 Vdc output models			2,200	μF
	9 Vdc output models			1,000	μF
	12 Vdc output models			680	μF
	15 Vdc output models			470	μF
	24 Vdc output models			100	μF
voltage accuracy			±1	±3	%
line regulation	from low line to high line, full load		±0.2	±0.5	%
load regulation	from 0% to full load		±0.5	±1	%
start-up time	at nominal input voltage		10		ms
switching frequency <sup>2</sup>	PWM mode		350		kHz
transient recovery time	25% load step change, nominal input voltage		300	500	μs
transient response deviation	25% load step change, nominal input voltage		±3	±5	%
temperature coefficient	at full load			±0.03	%/°C

Note: 2. Value is based on full load. At loads <50%, the switching frequency decreases with decreasing load.

## PROTECTIONS

parameter	conditions/description	min	typ	max	units
over current protection			150	250	%
short circuit protection	hiccup				

## SAFETY AND COMPLIANCE

parameter	conditions/description	min	typ	max	units
isolation voltage	input to output for 1 minute at 1 mA	1,500			Vdc
isolation resistance	input to output at 500 Vdc	1,000			MΩ
isolation capacitance	input to output, 100 kHz / 0.1 V		1,000		pF
safety approvals <sup>3</sup>	UL 60950-1				
conducted emissions	CISPR22/EN55022, class B (external circuit required, see Figure 2-b)				

Note: 3. See specific models noted on page 1.

**SAFETY AND COMPLIANCE (CONTINUED)**

parameter	conditions/description	min	typ	max	units
radiated emissions	CISPR22/EN55022, class B (external circuit required, see Figure 2-b)				
ESD	IEC/EN61000-4-2, contact $\pm$ 4kV, class B				
radiated immunity	IEC/EN61000-4-3, 10V/m, class A				
EFT/burst	IEC/EN61000-4-4, $\pm$ 2kV, class B (external circuit required, see Figure 2-a)				
surge	IEC/EN61000-4-5, line-line $\pm$ 2kV, class B (external circuit required, see Figure 2-a)				
conducted immunity	IEC/EN61000-4-6, 3 Vr.m.s, class A				
voltage dips & interruptions	IEC/EN61000-4-29, 0%-70%, class B				
MTBF	as per MIL-HDBK-217F, 25°C	1,000,000			hours
RoHS	2011/65/EU				

**ENVIRONMENTAL**

parameter	conditions/description	min	typ	max	units
operating temperature	see derating curve	-40		85	°C
storage temperature		-55		125	°C
storage humidity	non-condensing	5		95	%
case temperature rise	Ta=25°C, at nominal input voltage, full load		40		°C
vibration	10~55 Hz for 30 minutes on each axis		10		G

**SOLDERABILITY**

parameter	conditions/description	min	typ	max	units
reflow soldering	Maximum duration >217°C is 60 seconds. For actual application, refer to IPC/JEDEC J-STD-020D.1			245	°C

**MECHANICAL**

parameter	conditions/description	min	typ	max	units
dimensions	19.20 x 18.10 x 10.16 [0.756 x 0.713 x 0.400 inch]				mm
case material	black flame-retardant heat-proof plastic				
weight			3.5		g

## MECHANICAL DRAWING

units: mm [inch]  
 tolerance:  $\pm 0.50[\pm 0.020]$   
 pin diameter tolerance:  $\pm 0.10[\pm 0.004]$

PIN CONNECTIONS	
PIN	Function
1	GND
2	CTRL
6	NC
7	NC
8	+Vout
9	0V
14	Vin

NC=no connection

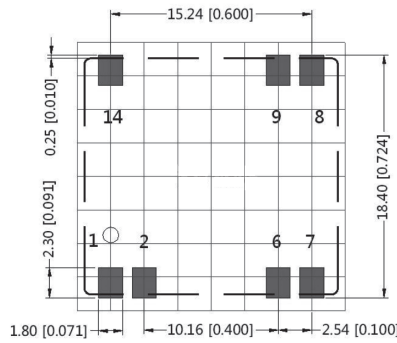
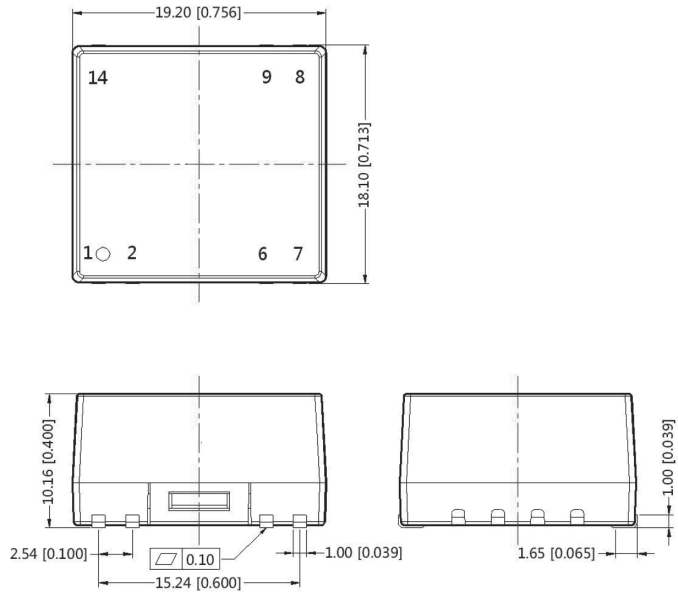

Note: 2.54 x 2.54 mm grid

Recommended PCB Layout  
Top View

## DERATING CURVE

Temperature Derating Curve  
(Natural Convection)

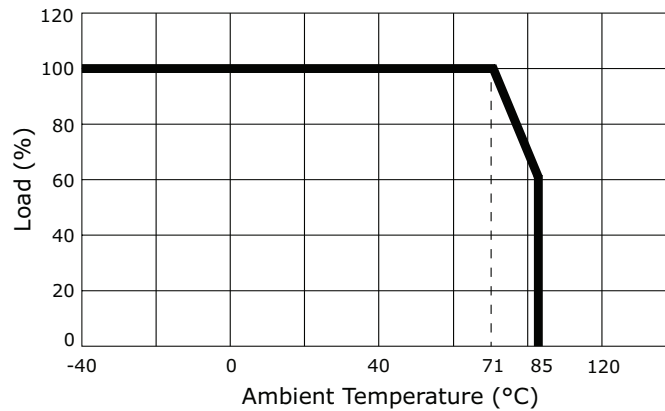

## APPLICATION CIRCUIT

This series has been tested according to the following recommended circuit (Figure 1) before leaving the factory. If you want to further reduce the input and output ripple, you can increase the input and output capacitors or select capacitors of low equivalent impedance provided that the capacitance is less than the maximum capacitive load of the model.

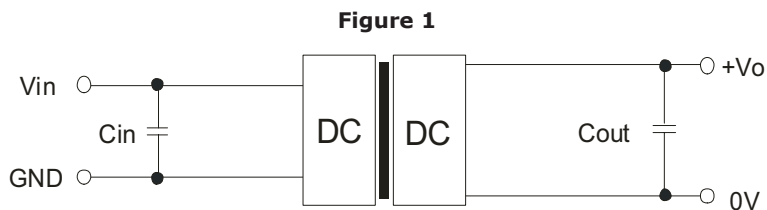
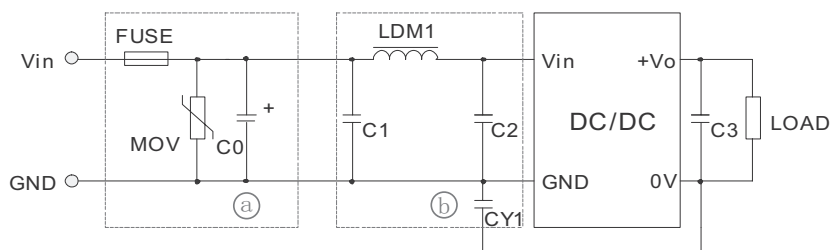

**Table 1**

Vin (Vdc)	Cin (μF)	Cout (μF)
24	100	10
48	10~47	10

## EMC RECOMMENDED CIRCUIT

**Figure 2**



**Table 2**

Recommended external circuit components		
Vin (Vdc)	24	48
FUSE	choose according to actual input current	
MOV	S20K30	S14K60
C0	680 μF / 50V	680 μF / 100V
C1, C2	4.7 μF / 50V	4.7 μF / 100V
C3	10 μF	
LDM1	12 μH	
CY1	1 nF / 2 kV	

## PACKAGING (TUBE)

units: mm

Tube Size: 21.6 x 13.2 x 530 mm

QTY: 26 pcs

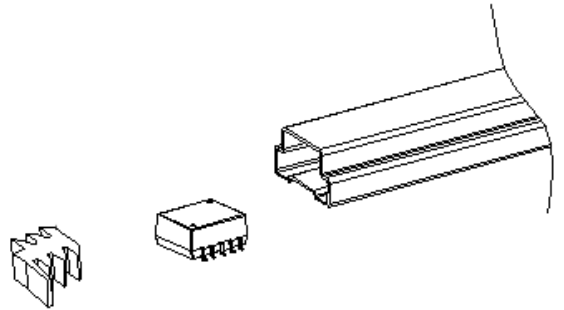
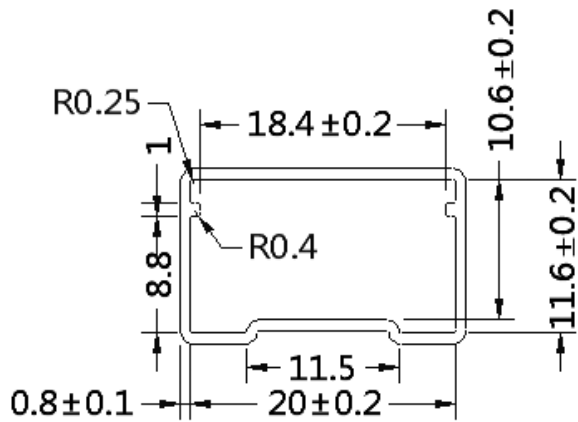

## PACKAGING (TAPE & REEL)

units: mm

Reel Size: Ø330 mm

QTY: 200 pcs per reel

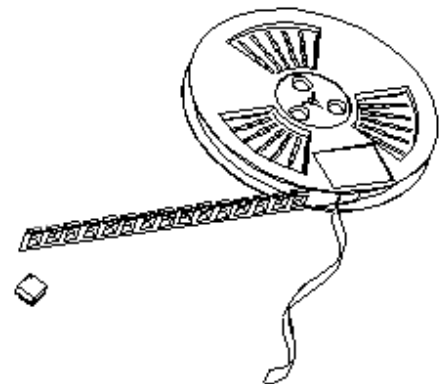
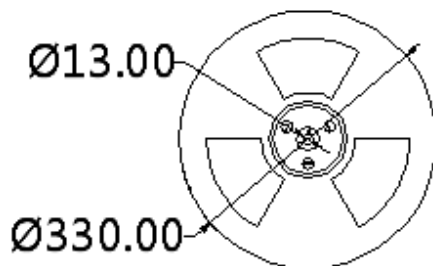
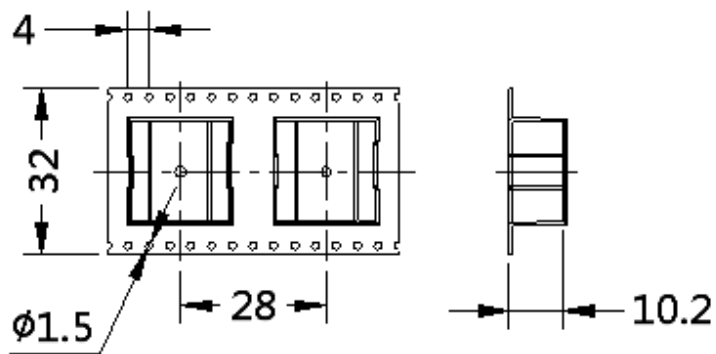

## REVISION HISTORY

---

rev.	description	date
1.0	initial release	04/18/2017

The revision history provided is for informational purposes only and is believed to be accurate.



**CUI INC**<sup>®</sup>

**Headquarters**  
20050 SW 112th Ave.  
Tualatin, OR 97062  
**800.275.4899**

Fax 503.612.2383  
**cui.com**  
techsupport@cui.com

CUI offers a two (2) year limited warranty. Complete warranty information is listed on our website.

CUI reserves the right to make changes to the product at any time without notice. Information provided by CUI is believed to be accurate and reliable. However, no responsibility is assumed by CUI for its use, nor for any infringements of patents or other rights of third parties which may result from its use.

CUI products are not authorized or warranted for use as critical components in equipment that requires an extremely high level of reliability. A critical component is any component of a life support device or system whose failure to perform can be reasonably expected to cause the failure of the life support device or system, or to affect its safety or effectiveness.