

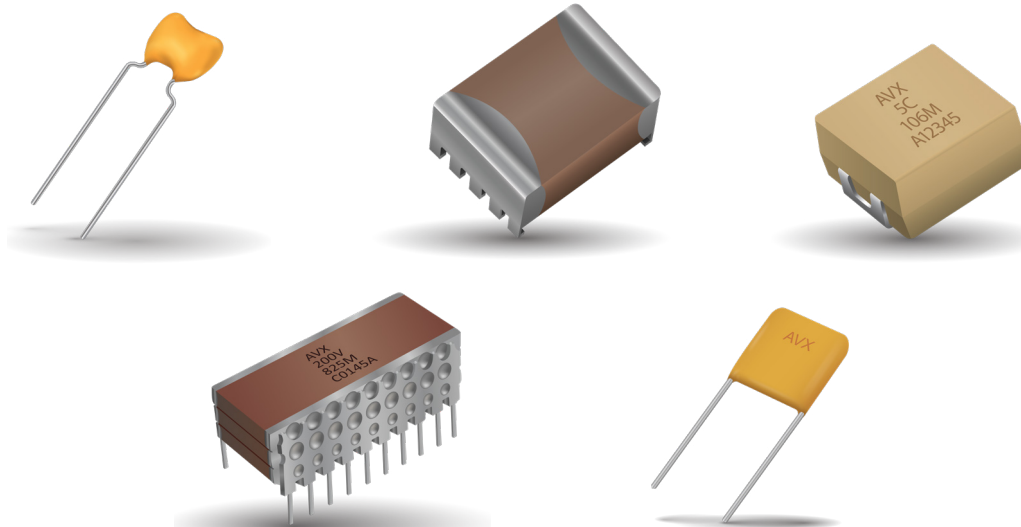

Advanced Ceramic Capacitors



IMPORTANT INFORMATION/DISCLAIMER

All product specifications, statements, information and data (collectively, the “Information”) in this datasheet or made available on the website are subject to change. The customer is responsible for checking and verifying the extent to which the Information contained in this publication is applicable to an order at the time the order is placed. All Information given herein is believed to be accurate and reliable, but it is presented without guarantee, warranty, or responsibility of any kind, expressed or implied.

Statements of suitability for certain applications are based on AVX’s knowledge of typical operating conditions for such applications, but are not intended to constitute and AVX specifically disclaims any warranty concerning suitability for a specific customer application or use.

ANY USE OF PRODUCT OUTSIDE OF SPECIFICATIONS OR ANY STORAGE OR INSTALLATION INCONSISTENT WITH PRODUCT GUIDANCE VOIDS ANY WARRANTY.

The Information is intended for use only by customers who have the requisite experience and capability to determine the correct products for their application. Any technical advice inferred from this Information or otherwise provided by AVX with reference to the use of AVX’s products is given without regard, and AVX assumes no obligation or liability for the advice given or results obtained.

Although AVX designs and manufactures its products to the most stringent quality and safety standards, given the current state of the art, isolated component failures may still occur. Accordingly, customer applications which require a high degree of reliability or safety should employ suitable designs or other safeguards (such as installation of protective circuitry or redundancies) in order to ensure that the failure of an electrical component does not result in a risk of personal injury or property damage.

Unless specifically agreed to in writing, AVX has not tested or certified its products, services or deliverables for use in high risk applications including medical life support, medical device, direct physical patient contact, water treatment, nuclear facilities, weapon systems, mass and air transportation control, flammable environments, or any other potentially life critical uses. Customer understands and agrees that AVX makes no assurances that the products, services or deliverables are suitable for any high-risk uses. Under no circumstances does AVX warrant or guarantee suitability for any customer design or manufacturing process.

Although all product–related warnings, cautions and notes must be observed, the customer should not assume that all safety measures are indicated or that other measures may not be required.

Advanced Ceramic Capacitors

Table of Contents



Introduction – Application Specific MLCs	1
SMPS Capacitors	
SM Style Stacked MLC Capacitors	7
RM Style Stacked MLC Capacitors	35
SMM Style Stacked MLC Capacitors Extended Range.....	38
RMM Style Stacked MLC Capacitors Extended Range	40
SMX Style for High Temperature Applications up to 200°C	42
CH/CV - Radial, Dual-in-Line, 4 Terminal/SMT 'J' & 'L' Ranges.....	46
SXP Style for High Temperature Applications up to 200°C	51
TurboCap™	53
RoHS Compliant TurboCap™	56
Mini-TurboCap™	59
RoHS Compliant Mini-TurboCap™	61
MH Style Ceramic Capacitor.....	63
RH Style - Surface Mount 'J' Lead Range.....	64
Custom Geometries and Lead Configurations.....	66
Assembly Guidelines	67
SK Style – Commercial Radial Range	69
SE Style – Extended Commercial Radial Range.....	71
CECC Offering	73
High Voltage MLC Capacitors	
ESCC Qualified SMPS Capacitors	74
HV Styles (US Preferred Sizes) DIP Lead.....	80
RV Style – RoHS Compliant High Voltage DIP Ledged	83
CH Style – Radial, Dual-in-line & 'L' Lead SMT	86
CV Style – Chip Assemblies	87
CH/CV Style – Chip Assemblies.....	88
SV Style Radial Lead – Application Information	89
DSCC Radials.....	92
MLC Chip Capacitors	
Basic Construction	95
General Description	96
Surface Mounting Guide.....	100
MIL-PRF-123/Chips	105
AT Series – High Temperature MLCC – 200°C & 250°C Rated.....	110
High Voltage MLC Chips – For 600V to 5000V Applications	116
High Voltage MLC Chips – For 600V to 5000V Applications	120
High Voltage MLC Chips Tin/Lead Termination "B".....	121
High Voltage MLC Chips FLEXITERM®	123
Tip & Ring Chips	130
Tip & Ring Tin/Lead Termination "B"	132
Packaging – Automatic Insertion Packaging	134
Embossed Carrier Configuration – 4, 8 & 12mm Tape Only.....	135
Surface Mount CapGuard™	
Varistor/Capacitor Combination for EMI/Surge Suppression.....	136
Filtered Arrays XD Type	138
Baseline Management	
A Dedicated Facility / BS9100 Requirements	139
Advanced Application Specific Products	140



Introduction – Application Specific MLCs

Problem Solving at the Leading Edge

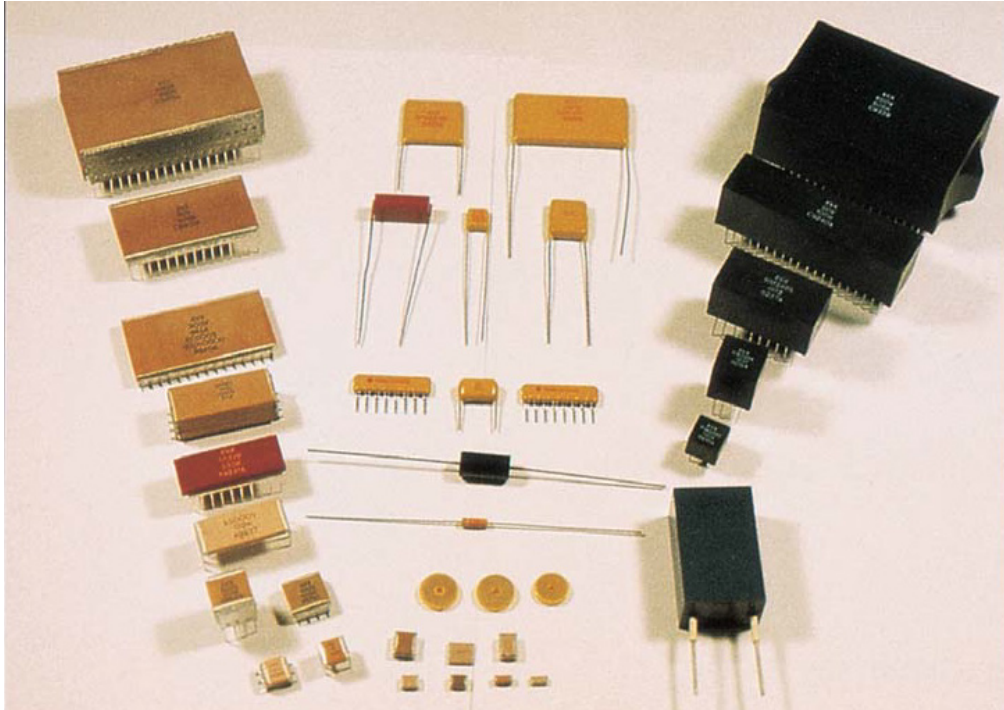

As the world's leading manufacturer and innovator in application specific multilayer ceramic (ASMLC) capacitors, AVX offers a unique technological and production capability to the field. AVX actively pursues and satisfies the high reliability and custom needs of a variety of governmental and industrial customers. Successful involvement in missile programs, extensive work in ultra-high reliability telecommunications and sophisticated capacitor design applications – all have established AVX as the source for advanced and high reliability ASMLC capacitors.

AVX Advanced Products are ISO9001 certified organizations for design and manufacturing of MLC capacitors.

AVX Advanced Application Capacitors are organized around three distinct functions:

- Application Specific Development Laboratories
- Advanced Manufacturing Facilities
- Quality Control

For designs or applications not listed please consult AVX Advanced Products.

Coleraine, Northern Ireland - ++44(0) 28703 44188

St. Appollinaire, France - ++33(0) 38071 7400



International Space Station



Defense / Military



Telecommunications
Undersea Cable Repeater

Application Specific MLCs

Problem Solving at the Leading Edge



APPLICATION SPECIFIC DEVELOPMENT LABORATORIES

Initially, AVX technical personnel communicate with customers to learn the requirements that the new capacitor must satisfy. The personnel involved are well-versed in material, manufacturing and electronic application technologies. They study the overall application and the environment in which the part will function. Programs are begun for selection of appropriate ceramic formulations, metal systems and designs. These programs yield a detailed technology profile from which mechanical design and process specifications follow.

ADVANCED MANUFACTURING FACILITIES

The ability and reputation of AVX in high reliability MLCs is due in part to the company's complete control over all phases of the production process. This includes powder processing, tape casting and/or wet build-up, green MLC assembly and final capacitor assembly/packaging. Recent renovations at AVX have upgraded green MLC assembly areas to certified clean room levels.

A favorite feature with many customers of AVX is our ability to work with customers in solving special packaging requirements. This includes special lead configurations and multiple chip packaging that simplifies the mounting of specialty capacitors. To the customer, the total capability of AVX assures a high level of consistent control

at all steps of production.

QUALITY CONTROL

The Q. A. organization is an integral part of manufacturing. Quality Control tests the product of each manufacturing process, detects flaws or variations from the narrow acceptable standard and isolates the cause of the deviation. Corrective action can then be taken to return the process to within its predetermined control levels.

Quality Assurance has large and well-equipped laboratories where statistical samples are evaluated and tested to determine failure rates, characterize products and assure compliance with specification. Both destructive and non-destructive testing are used, including advanced ultrasonic inspection equipment for non-destructive inspection of an entire production quantity.

Put the experience, technology and facilities of the leading company in multilayer ceramics to work for you. No other source offers the unique combination of capability and commitment to advanced application specific components.



SMPS Capacitors

SMPS Capacitor Applications



FOREWORD

High speed switch mode power supplies place high demands on the capacitors used in the input or output filters of Resonant DC-DC or Pulse Modulated DC-DC converters. AVX Corporation has developed several multilayer ceramic (MLC) capacitor styles for these switcher applications. These capacitors have been extensively tested and characterized and found to have almost ideal performances to meet the stringent requirements of these applications.

Input Filter Capacitor

The Input Filter capacitor is required to perform two functions: To supply an unrestricted burst of current to the power supply switch circuitry and to not only do it without generating any noise, but to help suppress noise generated in the switch circuitry. It is, in effect, a very large decoupling capacitor. It must have very low ESL, capabilities for very high dv/dt , as well as di/dt and it must have a very low ESR to eliminate power loss.

The distance from the primary DC source, as well as the type of capacitor used in this source (usually electrolytics), presents a very high inductance to the input of the Switcher. The MLC input capacitor, with its excellent ESL and ESR characteristics, is located physically close to the switch circuitry. Repetitive peak currents, inherent with the Switcher design, require a high ripple capability, as well as high surge capability for transients, both induced and conducted from other sources. MLCs have both these capabilities.

Output Filter Capacitor

The output from the switching circuit of a Switcher consists of current on and off. From an elevated DC reference, this current is an AC ripple additive on the DC. In order to smooth this ripple effect, a filter circuit (usually inductive input) is built to allow a storage of energy to take place during the rising ripple portion and to allow a discharge of energy during the falling ripple portion.

The ESR and ESL of the capacitor contribute to the net ripple effect. The output filter capacitor is chosen for ESR, and with previous types of capacitors, multiples were used in an attempt to lower the net ESR. The MLC offers ESRs well below the minimum allowable to lower noise levels, thus eliminating the need for multiple units.

Other MLC Capacitors for SMPS Applications

AVX also manufactures coupling, decoupling, resonant and snubber capacitors for SMPS applications. Contact AVX for Application Specific S.M.P.S. capacitor requirements.

Coleraine, Northern Ireland ++44(0) 28703 44188
St. Apollinaire, France ++33(0) 38071 7400

ASMLC CAPACITOR SELECTION

SMPS Design Information (SM, CH, CV, RH and SK Styles)

Absolute Maximum Output Capacitance
Assuming no ESL and no ESR

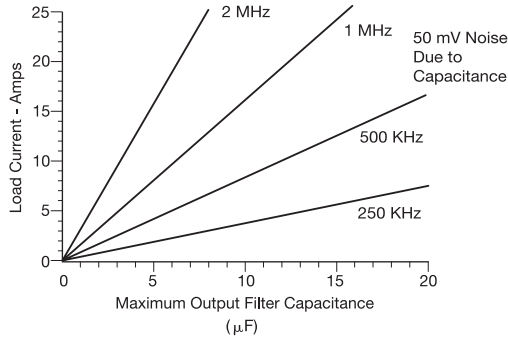

Absolute Maximum Capacitance ESL
Assuming no ESR - Capacitive Induced Ripple

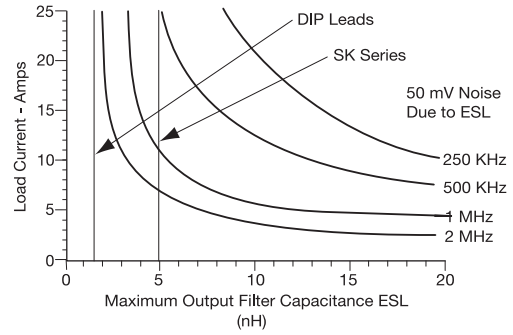

Absolute Maximum Capacitance ESR
Assuming no ESL - Capacitive Induced Ripple

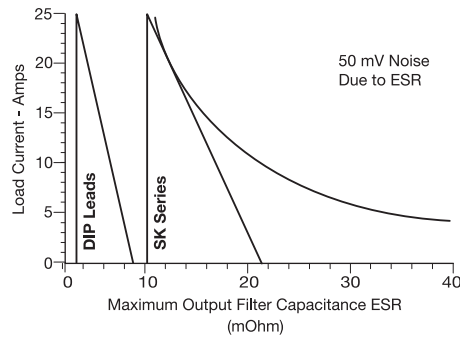

ASMLC CAPACITOR PERFORMANCE

Capacitance as Measured from dv/dt Slope
200 mA/ns Current Pulse
Measurement starts after inductive ring decay

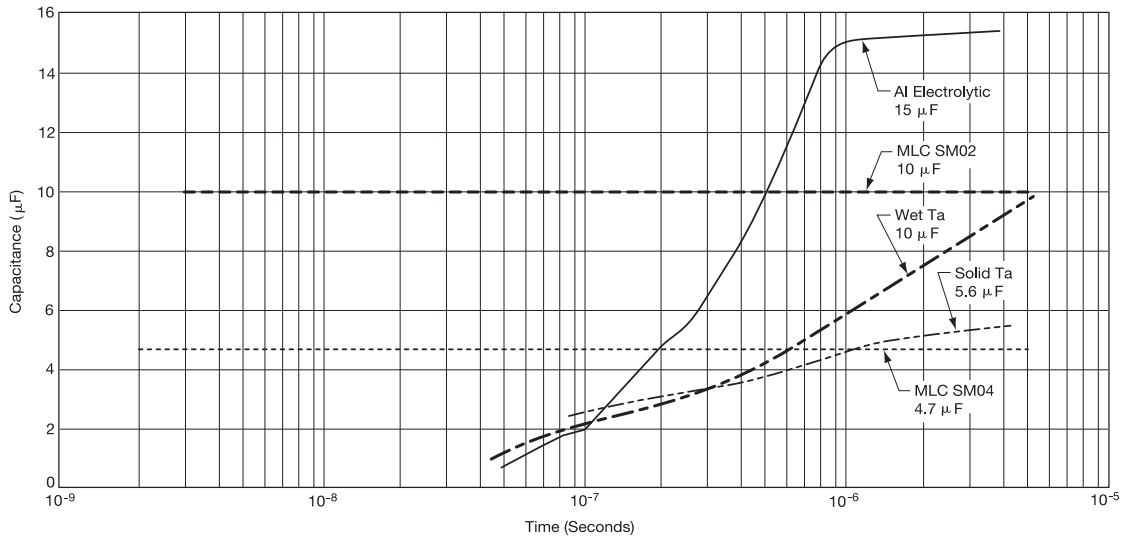

SMPS Capacitors

Capacitor Performance

AC Ripple Capability

Due to the wide range of product offering in this catalog, the AC ripple capabilities for switch mode power supply capacitors and high voltage capacitors are provided in the form of IBM compatible software package called SpiCalci. It is available free from AVX and can be downloaded for free from AVX website: <http://www.avx.com/download/software/SpiCalci-AVX.zip>.



SpiCalci program will provide answers to most of the design engineers' questions on critical parameters for their specific applications:

- Equivalent Series Resistance
 - function of frequency and temperature
- Equivalent Series Inductance
 - function of design
- Self Resonant Frequency

$$f = 1 / (2 \times \pi \sqrt{L \times C})$$
- Thermal Characteristics
 - function of design
- AC Ripple Capabilities
 - function of frequency, temperature and design

Examples of Product Performance

TYPICAL ESR -vs- Frequency FOR SM04 STYLE CAPACITORS

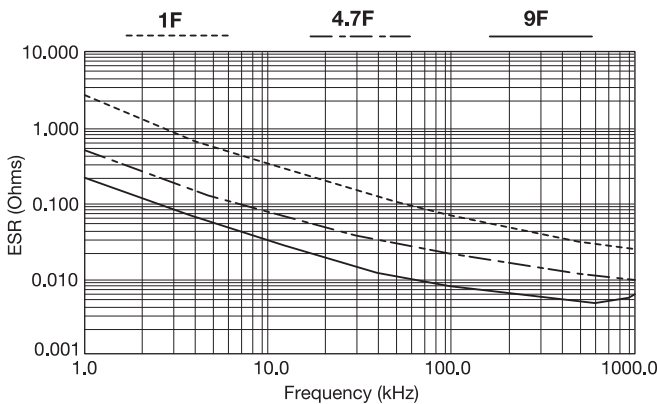

MAXIMUM RMS CURRENT FOR 50 VDC, CH - X7R @ 100 KHz & 25°C Ambient ASSUMING MAX. CAP. FOR SINGLE CHIP CONSTRUCTION

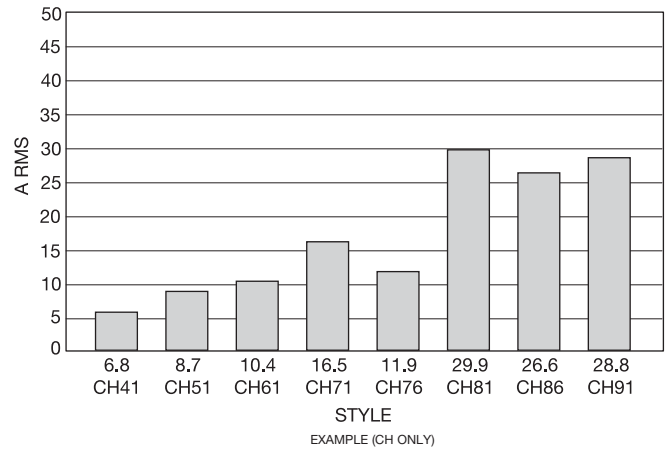

MAXIMUM RMS CURRENT FOR 50 WVDC, SM - X7R @ 100 KHz & 25°C Ambient ASSUMING MAX. CAP. FOR SINGLE CHIP CONSTRUCTION

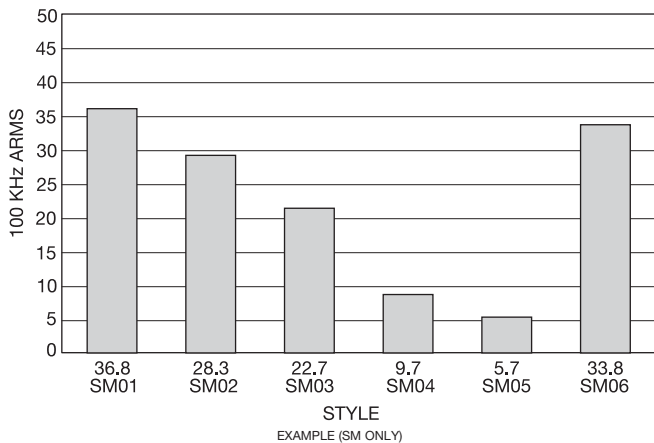

MAXIMUM RMS CURRENT FOR 25 WVDC, SK - Z5U @ 100 KHz & 25°C Ambient ASSUMING MAX. CAP. FOR EACH STYLE

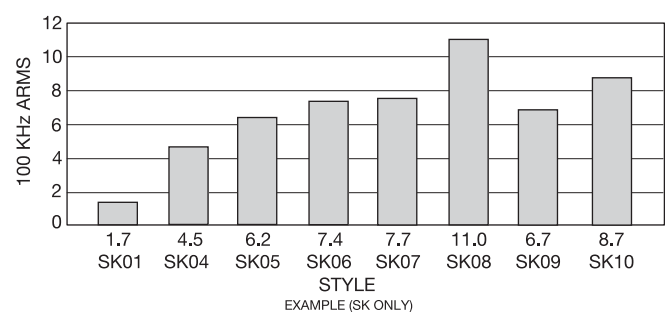

SMPS Capacitors

Application Information on SupraCap®

SUPRACAP® - LARGE CAPACITANCE VALUE MLCs

High speed switch mode power supplies require extremely low equivalent series resistance (ESR) and equivalent series inductance (ESL) capacitors for input and output filtering. These requirements are beyond the practical limits of electrolytic capacitors, both aluminum and tantalums, but are readily met by multilayer ceramic (MLCs) capacitors (Figure 1).

Theoretical SMPS's output filter capacitor values are in the range of 6-10 $\mu\text{F}/\text{amp}$ at 40KHz and drop to less than 1 $\mu\text{F}/\text{amp}$ at 1MHz. Most electrolytic applications use 10 to 100 times the theoretical value in order to obtain lower ESR from paralleling many capacitors. This is not necessary with SupraCap® MLC capacitors which inherently have ESRs in the range of milliohms. These extremely low values of ESR mean low ripple voltage and less self-heating of the capacitor.

Output noise spikes are reduced by lowering the filter capacitance self-inductance. The ripple current is a triangle wave form with constant di/dt except when it changes polarity, then the di/dt is very high. The noise voltage generated by the filter capacitor is

$$V_{\text{Noise}} = L_{\text{Capacitor}} di/dt$$

AVX SupraCap® devices have inductance value less than 3nH.

Figure 2 compares a 5.6 μF MLC to a 5.6 μF tantalum which was specially designed for low ESR and ESL. When subjected to a di/dt of 200 mA/ns the tantalum shows an ESR of 165 m Ω and an ESL of 18nH versus the MLC's 4 m Ω and 0.3 nH. These performance differences allow considerable reduction in size and weight of the filter capacitor.

Additionally, MLCs are compatible with surface mount technology reflow and assembly techniques which is the desirable assembly for conversion frequencies exceeding 1 MHz. Electrolytic capacitors (both aluminum and tantalum) are not compatible with normal vapor phase (VPS) or infrared (IR) reflow temperatures (205-215°C) due to electrolyte and structural problems. AVX SupraCap® devices are supplied with lead frames for either thru-hole or surface mount assembly. The lead frames act as stress relief for differences in coefficients of expansion between the large ceramic chip (10 ppm/°C) and the PC boards.

ESR Comparison of Different Capacitor Technologies
ESR -vs- Frequency
100 μF Filter Capacitors

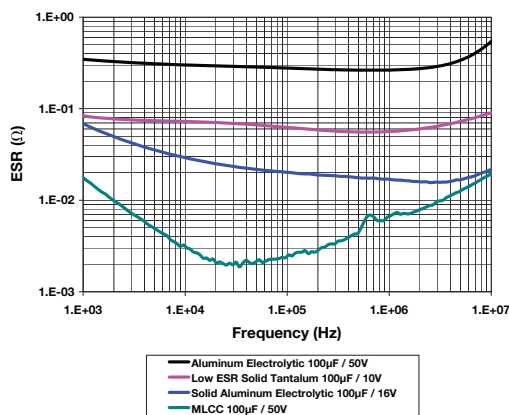

Figure 1

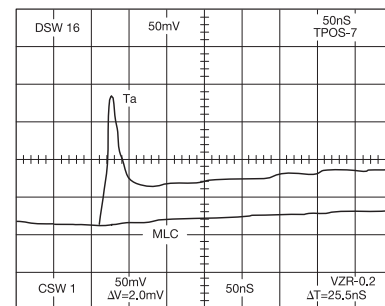
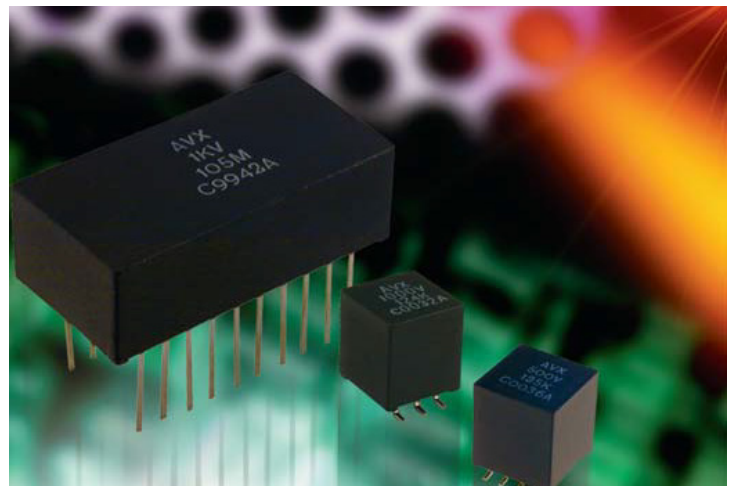
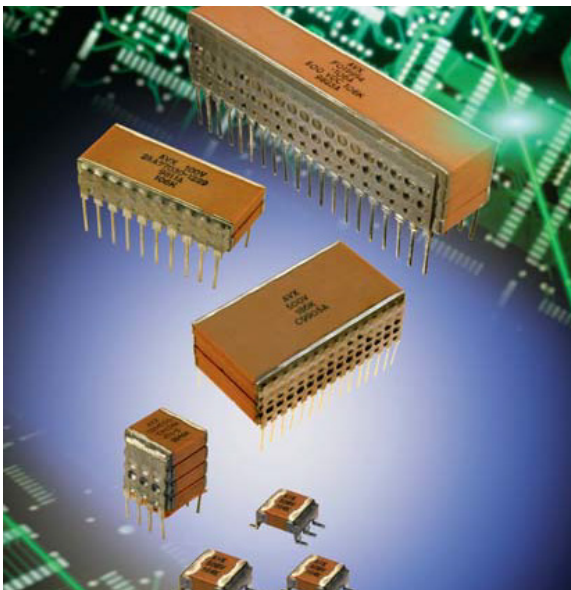
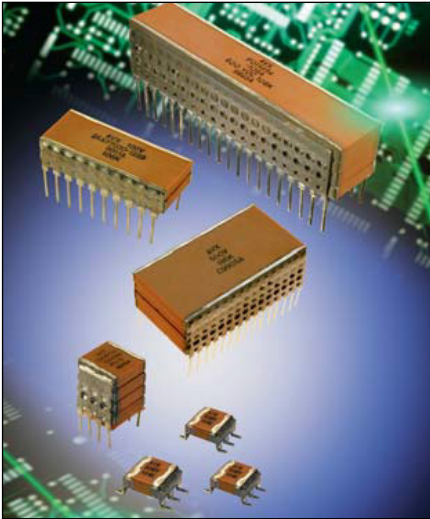

Figure 2



SMPS Stacked MLC Capacitors

SM Style Stacked MLC Capacitors



AVX is the original inventor of large capacitance value, stacked MLCC capacitors constructed with DIP leads. The SM-style, Switch Mode Power Supply (SMPS) capacitors were introduced by AVX in 1980s. These capacitors are the closest to the ideal electrical energy storage devices due to high CV product and extremely low ESR and ESL.

In addition to traditionally offered COG (Class I) and X7R (Class II) type dielectrics, AVX introduces another class I, temperature compensated N1500 dielectric characterized with very low dissipation factor. Thanks to considerably higher relative dielectric constant of N1500 dielectric, the CV product is more than doubled in comparison to ultra-stable COG dielectric, resulting in a significant reduction in the size of capacitor and a significant improvement of volumetric efficiency.

The typical applications for different type dielectrics are:

- COG: High frequency resonant capacitors, avionic AC line filters (400Hz to 800Hz), snubbers, timing circuits, high current repetitive discharge
- N1500: Avionic AC line filters (400Hz to 800Hz), snubbers, high current repetitive discharge, capacitive temperature compensation
- X7R: General filtering, input and output filters in DC/DC converters, bulk filters, DC link capacitors, motor drive filters, high current non-repetitive discharge

Not RoHS Compliant

GENERAL SPECIFICATIONS FOR ALL DIELECTRIC TYPES

Operating Temperature Range

-55° to +125°C

Voltage Ratings

50VDC through 500VDC (+125°C)

Dielectric Withstanding Voltage

250% rated voltage for 5 seconds with 30 to 50mA charging current (500 Volt units @ 750VDC)

Insulation Resistance (25°C, rated DC voltage)

100KMΩ min. or 1000MΩ-μF min. whichever is less

Insulation Resistance (125°C, rated DC voltage)

10KMΩ min. or 100MΩ-μF min. whichever is less

Thermal Shock Capabilities

5 cycles (-55°C to +125°C)

Life Test Capabilities (1000 hours)

200% rated voltage at +125°C (500 Volt units @ 600VDC)

GENERAL SPECIFICATIONS FOR ALL DIELECTRIC TYPES

COG Dielectric

Capacitance Range

0.01μF to 15μF
(+25°C, 1.0 ± 0.2Vrms at 1kHz)

Capacitance Tolerances

±5%, ±10%, ±20%

Temperature Characteristic

0 ± 30 ppm/°C

Dissipation Factor

0.15% max.
(+25°C, 1.0 ± 0.2Vrms at 1kHz)

N1500

Capacitance Range

0.018μF to 33μF
(+25°C, 1.0 ± 0.2Vrms at 1kHz)

Capacitance Tolerances

±5%, ±10%, ±20%

Temperature Characteristic

-1500 ± 250 ppm/°C

Dissipation Factor

0.15% max.
(+25°C, 1.0 ± 0.2Vrms at 1kHz)

X7R Dielectric

Capacitance Range

0.1μF to 390μF
(+25°C, 1.0 ± 0.2Vrms at 1kHz)

Capacitance Tolerances

±10%, ±20%, +80%, -20%

Temperature Characteristic

±15%

Dissipation Factor

2.5% max.
(+25°C, 1.0 ± 0.2Vrms at 1kHz)

SMPS Stacked MLC Capacitors

SM Style Stacked MLC Capacitors



HOW TO ORDER

AVX Styles: SM-1, SM-2, SM-3, SM-4, SM-5, SM-6

SM0	1	7	C	106	M	A	N	650
AVX Style SM0 = Uncoated SM5 = Epoxy Coated	Size See Dimensions chart	Voltage 50V = 5 100V = 1 200V = 2 500V = 7	Temperature Coefficient COG = A N1500 = 4 X7R = C	Capacitance Code (2 significant digits + number of zeros) 1,000 pF = 102 22,000 pF = 223 220,000 pF = 224 1 μF = 105 10 μF = 106 100 μF = 107	Capacitance Tolerance COG/N1500: J = ±5% K = ±10% M = ±20% X7R: K = ±10% M = ±20% Z = +80%, -20%	Test Level A = Standard B = Hi-Rel* 5 = Standard/MIL** 6 = Hi-Rel/MIL***	Termination N = Straight Lead J = Leads formed in L = Leads formed out P = P Style Leads Z = Z Style Leads	Height Max Dimension "A" 120 = 0.120" 240 = 0.240" 360 = 0.360" 480 = 0.480" 650 = 0.650"

See tables for capacitance available in specific height and dielectric

Note: Capacitors with X7R dielectric are not intended for applications across AC supply mains or AC line filtering with polarity reversal. Contact plant for recommendations.

* Hi-Rel screening option. Screening consists of 100% Group A (B Level), Subgroup 1 per MIL-PRF-49470.

** Form, fit & function equivalent to MIL-PRF-49470 part.

Applies to 50V rated parts only. No screening.
*** Form, fit & function equivalent to MIL-PRF-49470 part.
Applies to 50V rated parts only. Hi-Rel screening the same as option B.

Typical ESR Performance (mΩ)

	Aluminum Electrolytic 100μF/50V	Low ESR Solid Tantalum 100μF/10V	Solid Aluminum Electrolytic 100μF/16V	MLCC SMPS 100μF/50V	MLCC SMPS 4.7μF/50V
ESR @ 10KHz	300	72	29	3	66
ESR @ 50KHz	285	67	22	2	23
ESR @ 100KHz	280	62	20	2.5	15
ESR @ 500KHz	265	56	18	4	8
ESR @ 1MHz	265	56	17	7	7.5
ESR @ 5MHz	335	72	17	12.5	8
ESR @ 10MHz	560	91	22	20	14

Performance of SMPS capacitors can be simulated by downloading SpiCalci software program - <http://www.avx.com/download/software/SpiCalci-AVX.zip>



SMPS Stacked MLC Capacitors

SM Style Surface Mount and Thru-Hole Styles (SM0, SM5)

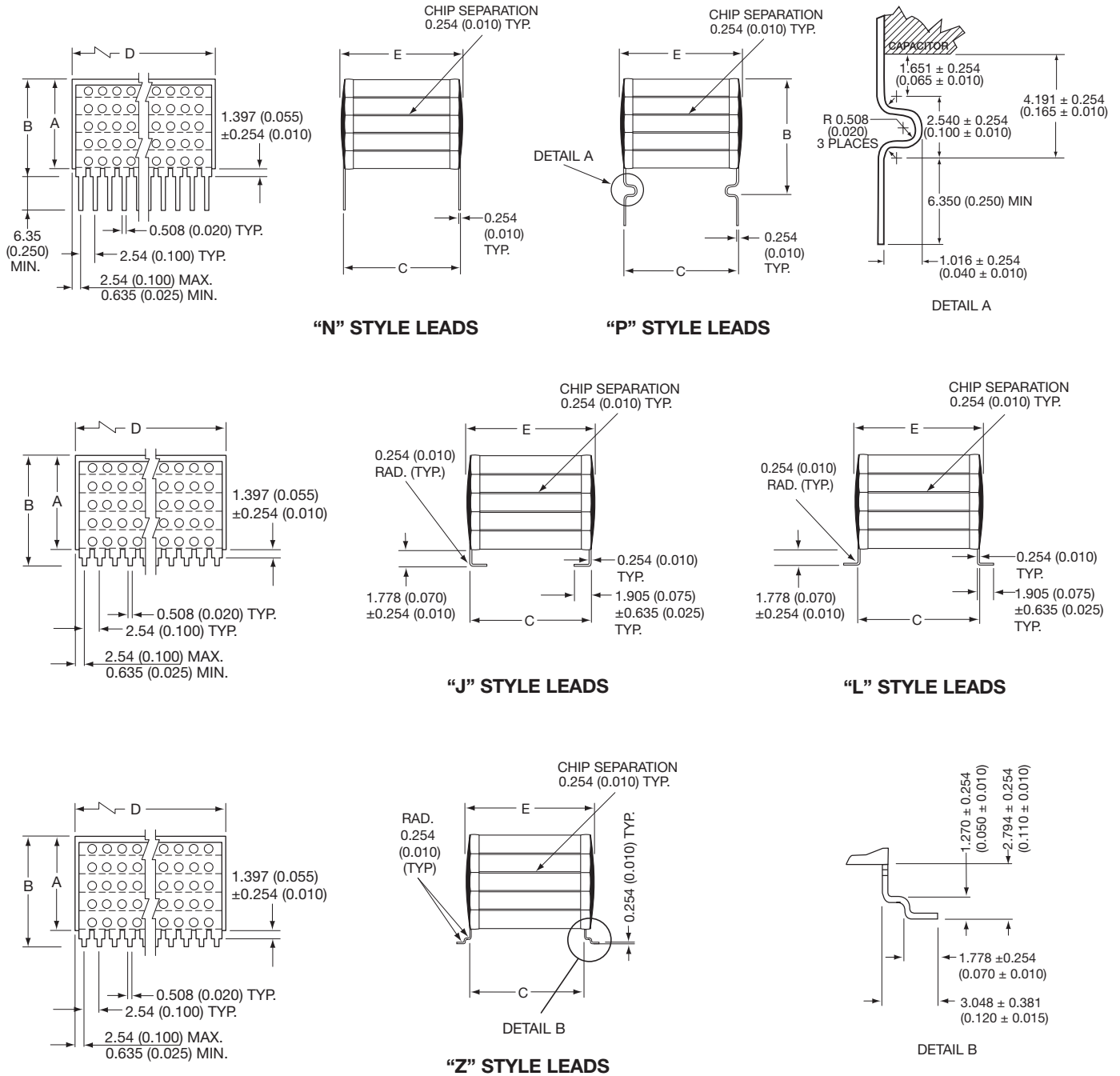

DIMENSIONS

millimeters (inches)

Style	A (max.)	B (max.)	C ±.635 (±0.025)	D ±.635 (±0.025)	E (max.)	No. of Leads per side
SM-1	See capacitance range table for maximum "A" dimensions	For "N" Style Leads: "A" Dimension Plus 1.651 (0.065) For "J" & "L" Style Leads: "A" Dimension Plus 2.032 (0.080) For "P" Style Leads: "A" Dimension Plus 4.445 (0.175) For "Z" Style Leads: "A" Dimension Plus 3.048 (0.120)	11.4 (0.450)	52.1 (2.050)	12.7 (0.500)	20
SM-2			20.3 (0.800)	38.4 (1.510)	22.1 (0.870)	15
SM-3			11.4 (0.450)	26.7 (1.050)	12.7 (0.500)	10
SM-4			10.2 (0.400)	10.2 (0.400)	11.2 (0.440)	4
SM-5			6.35 (0.250)	6.35 (0.250)	7.62 (0.300)	3
SM-6			31.8 (1.250)	52.1 (2.050)	34.3 (1.350)	20

Note: For SM5 add 0.127 (0.005) to max. and nominal dimensions A, B, D, & E

SMPS Stacked MLC Capacitors

SM Style



COG CLASS I DIELECTRIC, ULTRA STABLE CERAMIC

Cap μ F	SM01				SM02				SM03				SM04				SM05				SM06				
	50	100	200	500	50	100	200	500	50	100	200	500	50	100	200	500	50	100	200	500	50	100	200	500	
0.01																								120	
0.012																120			120	240					
0.015																120			120	240					
0.018																120			120	240					
0.022																240			240	360					
0.027																240		120	240	360					
0.033																240	120	120	240	480					
0.039																240	120	120	240	480					
0.047																120	240	120	240	240	650				
0.056											120					120	360	240	240	360					
0.068											120					120	360	240	240	360					
0.082											120				120	240	480	240	360	480					
0.1											240	120	120	240	480	240	360	480							
0.12				120							120	240	120	120	240	650	360	360	650						
0.15				120				120			120	240	120	240	360		360	480							
0.18				120				120			120	240	240	240	360		480	650							
0.22				240				120			240	360	240	240	480		650								
0.27			120	240				240		120	240	360	240	360	480										
0.33			120	240				240	120	120	240	480	360	360	650									120	
0.39			120	360				120	240	120	120	240	650	360	360									120	
0.47			240	360				120	240	120	240	360	650	360	480									120	
0.56		120	240	480				120	360	240	240	360		480	650									240	
0.68		120	240	480				120	240	360	240	480		650										240	
0.82	120	240	360	650	120	120	240	480	240	360	650												120	240	
1	120	240	360		120	120	240	480	240	360	650												120	240	
1.2	240	240	360		120	240	240	650	360	360												120	120	360	
1.5	240	360	480		240	240	360		360	480												120	240	360	
1.8	240	360	650		240	240	360		480	650												120	120	240	480
2.2	360	480			240	360	480		650													120	120	240	650
2.7	360	480			360	360	650															120	240	360	
3.3	480	650			360	480																240	240	360	
3.9	480				480	480																240	240	360	
4.7	650				480	650																240	240	480	
5.6					650																	240	360	650	
6.8																						360	360		
8.2																						360	480		
10																						480	650		
12																						480	650		
15																						650			

The number represented in each cell corresponds to the maximum "A" dimension (in mils) and to the last 3 digits of the part number.

CUSTOM VALUES, RATING AND CONFIGURATIONS ARE ALSO AVAILABLE.

SMPS Stacked MLC Capacitors

SM Style



X7R CLASS II DIELECTRIC, STABLE CERAMIC

Cap μ F	SM01				SM02				SM03				SM04				SM05				SM06						
	50	100	200	500	50	100	200	500	50	100	200	500	50	100	200	500	50	100	200	500	50	100	200	500			
0.1																								120			
0.12																								120			
0.15																				120	120						
0.18															120				120	240							
0.22															120				120	240							
0.27															120				120	240							
0.33															120				120	360							
0.39															120		120		120	360							
0.47															240		120		240	360							
0.56															120	240		120	240	480							
0.68											120			120	240			120	240	650							
0.82											120			120	360			240	360								
1											120			120	120	360	120	240	360								
1.2											120			120	240	360	120	240	360								
1.5				120							240			120	240	480	120	360	480								
1.8				120							120	240		120	240	650	120	360	650								
2.2				120							120	240		240	240			120	480								
2.7				240							120	360		240	360			120	480								
3.3				240							120	120	360	120	240	360			240	650							
3.9				120	240						120	240	360	120	360	480			240								
4.7				120	240						240	120	240	480	120	360	650			240				120			
5.6				120	360						120	240	650	120	480				240					120			
6.8				120	120	360					120	240		240	240				360					120			
8.2				120	240	480					120	360	120	240	360				240	650				120			
10				120	240	480					120	120	360	120	240	360			240					240			
12				120	240	650					120	240	360	120	240	480			240					120	240		
15				120	240	360					120	240	480	120	360	650			240					120	240		
18				120	240	360					120	240	650	120	360	650			360					120	240		
22				120	240	480					120	240	480		360				360					120	120	360	
27				120	240	480					120	240	360		240	650			480					120	120	360	
33				240	360	650					120	240	360		240				650					120	120	240	480
39				240	480						120	360	480		360									120	120	240	650
47				240	480						240	360	650		360									120	240	240	650
56				360	650						240	480	650		480									120	240	360	
68				360							240	480			480									120	240	360	
82				360							240	650			650									240	360	480	
100				480							360													240	360	650	
120				650							360													240	360	650	
150											480													240	480		
180											650													360	650		
220																								360			
270																								480			
330																								650			
390																								650			

The number represented in each cell corresponds to the maximum "A" dimension (in mils) and to the last 3 digits of the part number.

CUSTOM VALUES, RATING AND CONFIGURATIONS ARE ALSO AVAILABLE.

SMPS Stacked MLC Capacitors

SM Style SM Military Styles MIL-PRF-49470



AVX IS QUALIFIED TO MIL-PRF-49470/1 AND MIL-PRF-49470/2

The SMPS capacitors are designed for high current, high-power and high-temperature applications. These capacitors have very low ESR (Equivalent Series Resistance) and ESL (Equivalent Series Inductance). SMPS Series capacitors offer design and component engineers a proven technology specifically designed for programs requiring high reliability performance in harsh environments.

MIL-PRF-49470 SMPS Series capacitors are primarily used in input/output filters of high-power and high-voltage power supplies as well as in bus filters and DC snubbers for high power inverters and other high-current applications. These capacitors are available with through-hole and surface mount leads. The operating temperature is -55°C to +125°C.

The MIL-PRF-49470 capacitors are preferred over the DSCC drawing 87106 capacitors. MIL-PRF-49470 specification was created to produce a robust replacement for DSCC 87106. MIL-PRF-49470 offers two product levels.

Level "B" is the standard reliability. Level "T" is the high reliability suitable for space application.

AVX is qualified to supply MIL-PRF-49470/1 parts. These are unencapsulated ceramic dielectric, switch mode power supply capacitors. AVX is also qualified to supply MIL-PRF-49470/2 parts. These are encapsulated ceramic dielectric, switch mode power supply capacitors.

PLEASE CONTACT THE DLA WEBSITE

<http://www.landandmaritime.dla.mil/programs/milspec/DocSearch.aspx> for details on testing, electrical, mechanical and part number options.

PLEASE CONTACT THE DLA WEBSITE

<http://www.landandmaritime.dla.mil/Programs/QmlQpl/> for the latest QPL (Qualified Products List).

Not RoHS Compliant

HOW TO ORDER

<p>M49470</p> <p>Performance specification indicating MIL-PRF-49470</p>	<p>R</p> <p>Characteristic P = BP Q = BQ R = BR X = BX</p>	<p>01</p> <p>Performance specification sheet number 01 – indicating MIL-PRF-49470/1 02 – indicating MIL-PRF-49470/2</p>	<p>474</p> <p>Capacitance</p>	<p>K</p> <p>Capacitance Tolerance BP: J = ±5% K = ±10% BX, BR & BQ: K = ±10% M = ±20%</p>	<p>C</p> <p>Rated Voltage Z = 25V A = 50V B = 100V C = 200V E = 500V</p>	<p>N</p> <p>Configuration (Lead Style) See chart for Lead configurations</p>
--	---	--	--------------------------------------	--	---	---

For "T" level parts, replace the "M" in the pin with "T" (for example M49470R01474KCN becomes T49470R01474KCN) MIL-PRF-49470 contains additional capacitors that are not available in 87106, such as additional lead configurations and lower profile parts.

On the pages to follow is the general dimensional outline along with a cross reference from 87106 parts to MIL-PRF-49470 parts.

LEAD CONFIGURATION

millimeters (inches)

Symbol (Last digit of military PN, 12th digit of AVX PN)	Lead Style	Height Profile (Dimension A)	Formed lead length, L
N	N (straight)	Standard	N/A
L	L (formed)	Standard	1.78 ± 0.25 (0.070 ± 0.010)
M	L (formed)	Standard	1.14 ± 0.25 (0.045 ± 0.010)
J	J (formed)	Standard	1.78 ± 0.25 (0.070 ± 0.010)
K	J (formed)	Standard	1.14 ± 0.25 (0.045 ± 0.010)
A	N (straight)	Low	N/A
B	L (formed)	Low	1.78 ± 0.25 (0.070 ± 0.010)
D	L (formed)	Low	1.14 ± 0.25 (0.045 ± 0.010)
C	J (formed)	Low	1.78 ± 0.25 (0.070 ± 0.010)
F	J (formed)	Low	1.14 ± 0.25 (0.045 ± 0.010)

Note: Lead options available marked with a "-" as a place holder. See lead configuration column for available lead options to replace the "-".

Performance of SMPS capacitors can be simulated by downloading SpiCalci software program - <http://www.avx.com/download/software/SpiCalci-AVX.zip>



The Important Information/Disclaimer is incorporated in the catalog where these specifications came from or available online at www.avx.com/disclaimer/ by reference and should be reviewed in full before placing any order.

SMPS Stacked MLC Capacitors

SM Style SM Military Styles MIL-PRF-49470/1



MIL-PRF-49470/1

MIL-PRF-49470/1 - capacitor, fixed, ceramic dielectric, switch mode power supply (general purpose and temperature stable), standard reliability and high reliability unencapsulated, Style PS01.

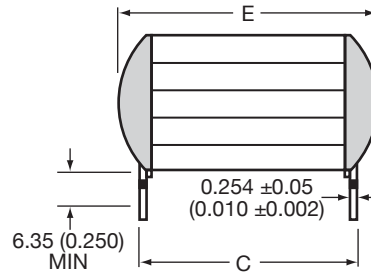
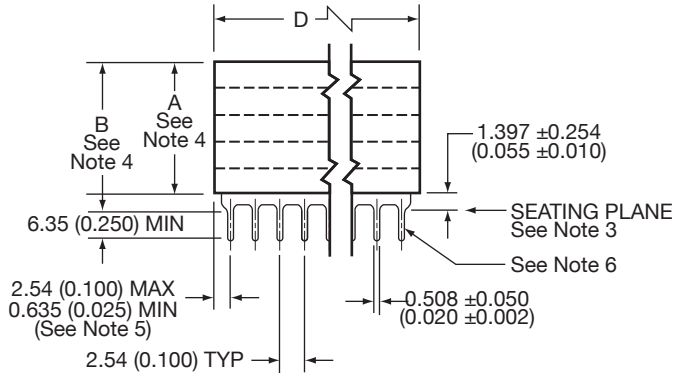

LEAD STYLE N AND A

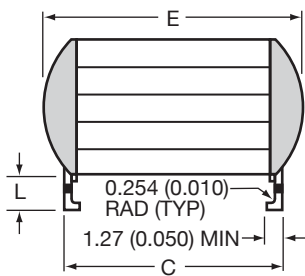

LEAD STYLE J AND C

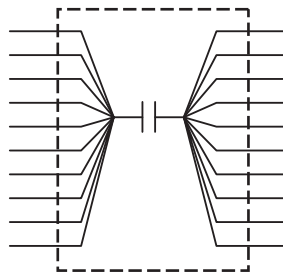

CIRCUIT DIAGRAM

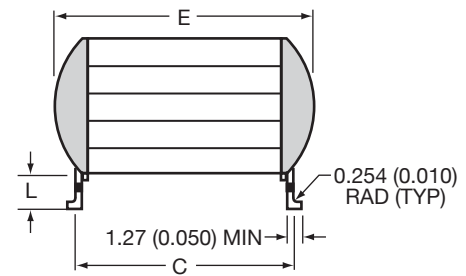

LEAD STYLE L AND B

DIMENSIONS:

millimeters (inches)

Case Code	C ±0.635 (±0.025)	D		E (max.)	Number of Leads per side
		Min.	Max.		
1	11.4 (0.450)	49.5 (1.950)	52.7 (2.075)	12.7 (0.500)	20
2	20.3 (0.800)	36.8 (1.450)	40.0 (1.535)	22.1 (0.870)	15
3	11.4 (0.450)	24.1 (0.950)	27.3 (1.075)	12.7 (0.500)	10
4	10.2 (0.400)	8.89 (0.350)	10.8 (0.425)	11.2 (0.440)	4
5	6.35 (0.250)	6.20 (0.224)	6.97 (0.275)	7.62 (0.300)	3
6	31.8 (1.250)	49.5 (1.950)	52.7 (2.075)	34.3 (1.350)	20

NOTES:

- Dimensions are in millimeters (inches)
- Unless otherwise specified, tolerances are 0.254 (±0.010).
- Lead frame configuration is shown as typical above the seating plane.
- See table I of MIL-PRF-49470/1 for specific maximum A dimension. For maximum B dimension, add 1.65 (0.065) to the appropriate A dimension. For all lead styles, the number of chips is determined by the capacitance and voltage rating.
- For case code 5, dimensions shall be 2.54 (0.100) maximum and 0.305 (0.012) minimum.
- Lead alignment within pin rows shall be within ±0.10 (0.005).

SMPS Stacked MLC Capacitors

SM Style SM Military Styles MIL-PRF-49470/2

MIL-PRF-49470/2

MIL-PRF-49470/2 - capacitor, fixed, ceramic dielectric, switch mode power supply (general purpose and temperature stable), standard reliability and high reliability encapsulated, Style PS02.

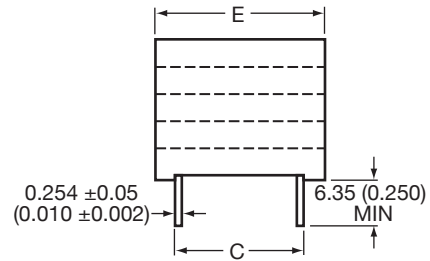
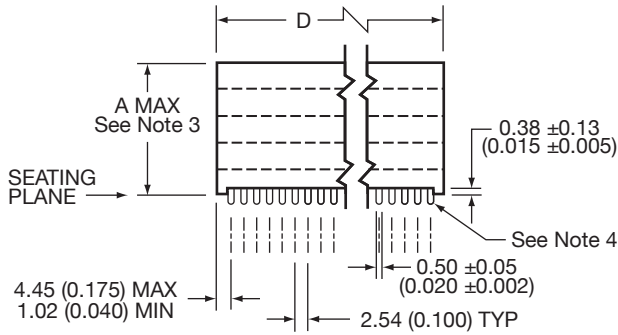

LEAD STYLE N AND A

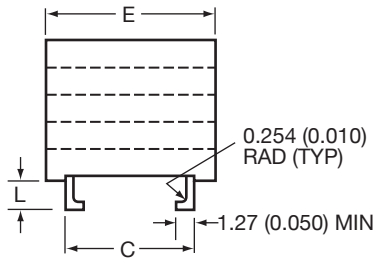

LEAD STYLE J AND C

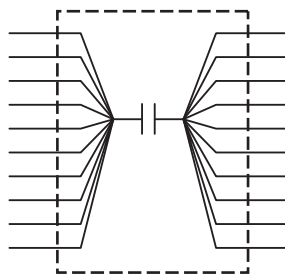

CIRCUIT DIAGRAM

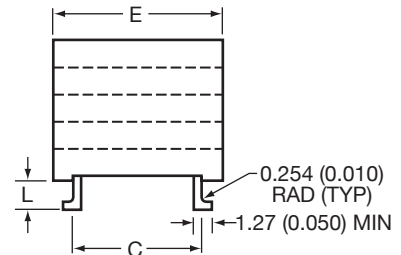

LEAD STYLE L AND B

DIMENSIONS:

millimeters (inches)

Case Code	C ±0.635 (±0.025)	D ±0.635 (±0.025)	E (max)	Number of Leads per side
1	11.4 (0.450)	54.7 (2.155)	14.7 (0.580)	20
2	20.3 (0.800)	41.0 (1.615)	24.1 (0.950)	15
3	11.4 (0.450)	29.3 (1.155)	14.7 (0.580)	10
4	10.2 (0.400)	12.3 (0.485)	12.3 (0.485)	4
5	6.35 (0.250)	9.02 (0.355)	9.02 (0.355)	3
6	31.8 (1.250)	54.7 (2.155)	36.3 (1.430)	20

NOTES:

- Dimensions are in millimeters (inches)
- Unless otherwise specified, tolerances are 0.254 (±0.001).
- See table I of MIL-PRF-49470/2 for specific maximum A dimension. For all lead styles, the number of chips is determined by the capacitance and voltage rating.
- Lead alignment within pin rows shall be within ±0.10 (0.004).

SMPS Stacked MLC Capacitors

SM Style SM Military Styles MIL-PRF-49470



MIL-PRF-49470 PIN 1/	AVX PART NUMBER (for reference only) 2/	Capacitance μ F	Tolerance	Characteristic	Case Code	Lead Configuration
25V						
-49470X0-155-Z	SM-53C155-H-120	1.5	K, M	BX	5	N, L, M, J, K
-49470X0-185-Z	SM-53C185-H-120	1.8	K, M	BX	5	N, L, M, J, K
-49470X0-225-Z	SM-53C225-H-120	2.2	K, M	BX	5	N, L, M, J, K
-49470X0-275-Z	SM-53C275-H-240	2.7	K, M	BX	5	N, L, M, J, K
-49470X0-335-Z	SM-53C335-H-240	3.3	K, M	BX	5	N, L, M, J, K
-49470X0-395-Z	SM-53C395-H-240	3.9	K, M	BX	5	N, L, M, J, K
-49470X0-475-Z	SM-53C475-H-240	4.7	K, M	BX	5	N, L, M, J, K
-49470X0-565-Z	SM-53C565-H-360	5.6	K, M	BX	5	N, L, M, J, K
-49470X0-685-Z	SM-53C685-H-360	6.8	K, M	BX	5	N, L, M, J, K
-49470X0-685-Z	SM-43C685-H-120	6.8	K, M	BX	4	A, B, D, C, F
-49470X0-825-Z	SM-53C825-H-480	8.2	K, M	BX	5	N, L, M, J, K
-49470X0-825-Z	SM-43C825-H-240	8.2	K, M	BX	4	A, B, D, C, F
-49470X0-106-Z	SM-53C106-H-650	10	K, M	BX	5	N, L, M, J, K
-49470X0-106-Z	SM-43C106-H-240	10	K, M	BX	4	A, B, D, C, F
-49470X0-126-Z	SM-43C126-H-240	12	K, M	BX	4	N, L, M, J, K
-49470X0-156-Z	SM-43C156-H-360	15	K, M	BX	4	N, L, M, J, K
-49470X0-156-Z	SM-33C156-H-120	15	K, M	BX	3	A, B, D, C, F
-49470X0-186-Z	SM-43C186-H-360	18	K, M	BX	4	N, L, M, J, K
-49470X0-186-Z	SM-33C186-H-120	18	K, M	BX	3	A, B, D, C, F
-49470X0-226-Z	SM-43C226-H-480	22	K, M	BX	4	N, L, M, J, K
-49470X0-226-Z	SM-33C226-H-240	22	K, M	BX	3	A, B, D, C, F
-49470X0-276-Z	SM-43C276-H-480	27	K, M	BX	4	N, L, M, J, K
-49470X0-276-Z	SM-33C276-H-240	27	K, M	BX	3	A, B, D, C, F
-49470X0-336-Z	SM-43C336-H-650	33	K, M	BX	4	N, L, M, J, K
-49470X0-336-Z	SM-33C336-H-240	33	K, M	BX	3	A, B, D, C, F
-49470X0-396-Z	SM-33C396-H-360	39	K, M	BX	3	N, L, M, J, K
-49470X0-396-Z	SM-13C396-H-240	39	K, M	BX	1	A, B, D, C, F
-49470X0-476-Z	SM-33C476-H-480	47	K, M	BX	3	N, L, M, J, K
-49470X0-476-Z	SM-13C476-H-360	47	K, M	BX	1	A, B, D, C, F
-49470X0-566-Z	SM-33C566-H-480	56	K, M	BX	3	N, L, M, J, K
-49470X0-566-Z	SM-13C566-H-360	56	K, M	BX	1	A, B, D, C, F
-49470X0-686-Z	SM-33C686-H-480	68	K, M	BX	3	N, L, M, J, K
-49470X0-686-Z	SM-13C686-H-360	68	K, M	BX	1	A, B, D, C, F
-49470X0-826-Z	SM-33C826-H-650	82	K, M	BX	3	N, L, M, J, K
-49470X0-826-Z	SM-13C826-H-360	82	K, M	BX	1	A, B, D, C, F
-49470X0-107-Z	SM-13C107-H-480	100	K, M	BX	1	N, L, M, J, K
-49470X0-107-Z	SM-23C107-H-360	100	K, M	BX	2	A, B, D, C, F
-49470X0-127-Z	SM-13C127-H-650	120	K, M	BX	1	N, L, M, J, K
-49470X0-127-Z	SM-23C127-H-360	120	K, M	BX	2	A, B, D, C, F
-49470X0-157-Z	SM-23C157-H-480	150	K, M	BX	2	N, L, M, J, K
-49470X0-157-Z	SM-63C157-H-240	150	K, M	BX	6	A, B, D, C, F
-49470X0-187-Z	SM-23C187-H-650	180	K, M	BX	2	N, L, M, J, K
-49470X0-187-Z	SM-63C187-H-360	180	K, M	BX	6	A, B, D, C, F
-49470X0-227-Z	SM-63C227-H-360	220	K, M	BX	6	N, L, M, J, K
-49470X0-277-Z	SM-63C277-H-480	270	K, M	BX	6	N, L, M, J, K
-49470X0-337-Z	SM-63C337-H-650	330	K, M	BX	6	N, L, M, J, K
-49470X0-397-Z	SM-63C397-H-650	390	K, M	BX	6	N, L, M, J, K
50V						
-49470P0-563-A	SM-55A563-H-120	0.056	J, K	BP	5	N, L, M, J, K
-49470P0-683-A	SM-55A683-H-240	0.068	J, K	BP	5	N, L, M, J, K
-49470P0-823-A	SM-55A823-H-240	0.082	J, K	BP	5	N, L, M, J, K
-49470P0-104-A	SM-55A104-H-240	0.1	J, K	BP	5	N, L, M, J, K
-49470P0-124-A	SM-55A124-H-360	0.12	J, K	BP	5	N, L, M, J, K
-49470P0-154-A	SM-55A154-H-360	0.15	J, K	BP	5	N, L, M, J, K
-49470P0-184-A	SM-55A184-H-480	0.18	J, K	BP	5	N, L, M, J, K
-49470P0-184-A	SM-45A184-H-240	0.18	J, K	BP	4	A, B, D, C, F

1/ Complete PIN shall include additional symbols replacing dashes (from left to right): product level (M for B level, or T for T level), part style (1 for unencapsulated, 2 for encapsulated), capacitance tolerance, lead configuration
 2/ Complete AVX Part Number (provided for reference only) shall include additional symbols replacing dashes (from left to right): part style (0 for unencapsulated and 9 for encapsulated), capacitance tolerance, lead configuration
 The last 3 digits of the AVX Part Number represent the chip height of the unencapsulated version. For the encapsulated version, replace the last 3 digits as follows: (120 replace with 270, 240 replace with 390, 360 replace with 530, 480 replace with 660 and 650 replace with 800).



SMPS Stacked MLC Capacitors

SM Style SM Military Styles MIL-PRF-49470



MIL-PRF-49470 PIN 1/	AVX PART NUMBER (for reference only) 2/	Capacitance μ F	Tolerance	Characteristic	Case Code	Lead Configuration
-49470P0-224-A-	SM-55A224-H-480	0.22	J, K	BP	5	N, L, M, J, K
-49470P0-224-A-	SM-45A224-H-240	0.22	J, K	BP	4	A, B, D, C, F
-49470P0-274-A-	SM-55A274-H-650	0.27	J, K	BP	5	N, L, M, J, K
-49470P0-274-A-	SM-45A274-H-240	0.27	J, K	BP	4	A, B, D, C, F
-49470P0-334-A-	SM-45A334-H-360	0.33	J, K	BP	4	N, L, M, J, K
-49470P0-394-A-	SM-45A394-H-480	0.39	J, K	BP	4	N, L, M, J, K
-49470P0-474-A-	SM-45A474-H-480	0.47	J, K	BP	4	N, L, M, J, K
-49470P0-564-A-	SM-45A564-H-650	0.56	J, K	BP	4	N, L, M, J, K
-49470P0-564-A-	SM-35A564-H-240	0.56	J, K	BP	3	A, B, D, C, F
-49470P0-684-A-	SM-35A684-H-240	0.68	J, K	BP	3	N, L, M, J, K
-49470P0-824-A-	SM-35A824-H-240	0.82	J, K	BP	3	N, L, M, J, K
-49470P0-105-A-	SM-35A105-H-360	1	J, K	BP	3	N, L, M, J, K
-49470X0-105-A-	SM-55C105-H-120	1	K, M	BX	5	N, L, M, J, K
-49470P0-125-A-	SM-35A125-H-360	1.2	J, K	BP	3	N, L, M, J, K
-49470X0-125-A-	SM-55C125-H-120	1.2	K, M	BX	5	N, L, M, J, K
-49470P0-155-A-	SM-35A155-H-480	1.5	J, K	BP	3	N, L, M, J, K
-49470X0-155-A-	SM-55C155-H-240	1.5	K, M	BX	5	N, L, M, J, K
-49470P0-185-A-	SM-35A185-H-480	1.8	J, K	BP	3	N, L, M, J, K
-49470X0-185-A-	SM-55C185-H-240	1.8	K, M	BX	5	N, L, M, J, K
-49470P0-225-A-	SM-35A225-H-650	2.2	J, K	BP	3	N, L, M, J, K
-49470X0-225-A-	SM-55C225-H-240	2.2	K, M	BX	5	N, L, M, J, K
-49470X0-275-A-	SM-55C275-H-360	2.7	K, M	BX	5	N, L, M, J, K
-49470X0-335-A-	SM-55C335-H-360	3.3	K, M	BX	5	N, L, M, J, K
-49470X0-395-A-	SM-55C395-H-480	3.9	K, M	BX	5	N, L, M, J, K
-49470X0-475-A-	SM-55C475-H-480	4.7	K, M	BX	5	N, L, M, J, K
-49470X0-475-A-	SM-45C475-H-240	4.7	K, M	BX	4	A, B, D, C, F
-49470X0-565-A-	SM-55C565-H-650	5.6	K, M	BX	5	N, L, M, J, K
-49470X0-565-A-	SM-45C565-H-240	5.6	K, M	BX	4	A, B, D, C, F
-49470X0-685-A-	SM-45C685-H-360	6.8	K, M	BX	4	N, L, M, J, K
-49470X0-825-A-	SM-45C825-H-360	8.2	K, M	BX	4	N, L, M, J, K
-49470X0-106-A-	SM-45C106-H-480	10	K, M	BX	4	N, L, M, J, K
-49470X0-126-A-	SM-45C126-H-480	12	K, M	BX	4	N, L, M, J, K
-49470X0-156-A-	SM-45C156-H-650	15	K, M	BX	4	N, L, M, J, K
-49470X0-156-A-	SM-35C156-H-240	15	K, M	BX	3	A, B, D, C, F
-49470X0-186-A-	SM-35C186-H-240	18	K, M	BX	3	N, L, M, J, K
-49470X0-226-A-	SM-35C226-H-360	22	K, M	BX	3	N, L, M, J, K
-49470X0-276-A-	SM-35C276-H-360	27	K, M	BX	3	N, L, M, J, K
-49470X0-336-A-	SM-35C336-H-360	33	K, M	BX	3	N, L, M, J, K
-49470X0-396-A-	SM-35C396-H-480	39	K, M	BX	3	N, L, M, J, K
-49470X0-476-A-	SM-35C476-H-650	47	K, M	BX	3	N, L, M, J, K
-49470X0-476-A-	SM-25C476-H-240	47	K, M	BX	2	A, B, D, C, F
-49470X0-566-A-	SM-15C566-H-360	56	K, M	BX	1	N, L, M, J, K
-49470X0-566-A-	SM-25C566-H-240	56	K, M	BX	2	A, B, D, C, F
-49470X0-686-A-	SM-15C686-H-480	68	K, M	BX	1	N, L, M, J, K
-49470X0-686-A-	SM-25C686-H-360	68	K, M	BX	2	A, B, D, C, F
-49470X0-826-A-	SM-15C826-H-480	82	K, M	BX	1	N, L, M, J, K
-49470X0-826-A-	SM-25C826-H-360	82	K, M	BX	2	A, B, D, C, F
-49470X0-107-A-	SM-15C107-H-650	100	K, M	BX	1	N, L, M, J, K
-49470X0-107-A-	SM-25C107-H-480	100	K, M	BX	2	A, B, D, C, F
-49470X0-127-A-	SM-25C127-H-480	120	K, M	BX	2	N, L, M, J, K
-49470X0-157-A-	SM-25C157-H-650	150	K, M	BX	2	N, L, M, J, K
-49470X0-187-A-	SM-65C187-H-480	180	K, M	BX	6	N, L, M, J, K
-49470X0-227-A-	SM-65C227-H-480	220	K, M	BX	6	N, L, M, J, K
-49470X0-277-A-	SM-65C277-H-650	270	K, M	BX	6	N, L, M, J, K
100V						
-49470P0-473-B-	SM-51A473-H-240	0.047	J, K	BP	5	N, L, M, J, K
-49470P0-563-B-	SM-51A563-H-240	0.056	J, K	BP	5	N, L, M, J, K

1/ Complete PIN shall include additional symbols replacing dashes (from left to right): product level (M for B level, or T for T level), part style (1 for unencapsulated, 2 for encapsulated), capacitance tolerance, lead configuration
 2/ Complete AVX Part Number (provided for reference only) shall include additional symbols replacing dashes (from left to right): part style (0 for unencapsulated and 9 for encapsulated), capacitance tolerance, lead configuration
 The last 3 digits of the AVX Part Number represent the chip height of the unencapsulated version. For the encapsulated version, replace the last 3 digits as follows: (120 replace with 270, 240 replace with 390, 360 replace with 530, 480 replace with 660 and 650 replace with 800).



The Important Information/Disclaimer is incorporated in the catalog where these specifications came from or available online at www.avx.com/disclaimer/ by reference and should be reviewed in full before placing any order.

SMPS Stacked MLC Capacitors

SM Style SM Military Styles MIL-PRF-49470



MIL-PRF-49470 PIN 1/	AVX PART NUMBER (for reference only) 2/	Capacitance μ F	Tolerance	Characteristic	Case Code	Lead Configuration
-49470P0-683-B-	SM-51A683-H-240	0.068	J, K	BP	5	N, L, M, J, K
-49470P0-823-B-	SM-51A823-H-240	0.082	J, K	BP	5	N, L, M, J, K
-49470P0-104-B-	SM-51A104-H-360	0.1	J, K	BP	5	N, L, M, J, K
-49470P0-124-B-	SM-51A124-H-360	0.12	J, K	BP	5	N, L, M, J, K
-49470P0-154-B-	SM-51A154-H-480	0.15	J, K	BP	5	N, L, M, J, K
-49470P0-154-B-	SM-41A154-H-240	0.15	J, K	BP	4	A, B, D, C, F
-49470P0-184-B-	SM-51A184-H-650	0.18	J, K	BP	5	N, L, M, J, K
-49470P0-184-B-	SM-41A184-H-240	0.18	J, K	BP	4	A, B, D, C, F
-49470P0-224-B-	SM-51A224-H-650	0.22	J, K	BP	5	N, L, M, J, K
-49470P0-224-B-	SM-41A224-H-240	0.22	J, K	BP	4	A, B, D, C, F
-49470P0-274-B-	SM-41A274-H-360	0.27	J, K	BP	4	N, L, M, J, K
-49470P0-334-B-	SM-41A334-H-480	0.33	J, K	BP	4	N, L, M, J, K
-49470P0-394-B-	SM-41A394-H-480	0.39	J, K	BP	4	N, L, M, J, K
-49470P0-474-B-	SM-41A474-H-650	0.47	J, K	BP	4	N, L, M, J, K
-49470P0-474-B-	SM-31A474-H-240	0.47	J, K	BP	3	A, B, D, C, F
-49470P0-564-B-	SM-41A564-H-650	0.56	J, K	BP	4	N, L, M, J, K
-49470P0-564-B-	SM-31A564-H-240	0.56	J, K	BP	3	A, B, D, C, F
-49470P0-684-B-	SM-31A684-H-240	0.68	J, K	BP	3	N, L, M, J, K
-49470X0-684-B-	SM-51C684-H-120	0.68	K, M	BX	5	N, L, M, J, K
-49470P0-824-B-	SM-31A824-H-360	0.82	J, K	BP	3	N, L, M, J, K
-49470X0-824-B-	SM-51C824-H-240	0.82	K, M	BX	5	N, L, M, J, K
-49470P0-105-B-	SM-31A105-H-360	1	J, K	BP	3	N, L, M, J, K
-49470X0-105-B-	SM-51C105-H-240	1	K, M	BX	5	N, L, M, J, K
-49470P0-125-B-	SM-31A125-H-480	1.2	J, K	BP	3	N, L, M, J, K
-49470X0-125-B-	SM-51C125-H-240	1.2	K, M	BX	5	N, L, M, J, K
-49470P0-155-B-	SM-31A155-H-480	1.5	J, K	BP	3	N, L, M, J, K
-49470X0-155-B-	SM-51C155-H-360	1.5	K, M	BX	5	N, L, M, J, K
-49470P0-185-B-	SM-31A185-H-650	1.8	J, K	BP	3	N, L, M, J, K
-49470X0-185-B-	SM-51C185-H-360	1.8	K, M	BX	5	N, L, M, J, K
-49470X0-225-B-	SM-51C225-H-480	2.2	K, M	BX	5	N, L, M, J, K
-49470X0-225-B-	SM-41C225-H-240	2.2	K, M	BX	4	A, B, D, C, F
-49470X0-275-B-	SM-51C275-H-480	2.7	K, M	BX	5	N, L, M, J, K
-49470X0-335-B-	SM-51C335-H-650	3.3	K, M	BX	5	N, L, M, J, K
-49470X0-335-B-	SM-41C335-H-240	3.3	K, M	BX	4	A, B, D, C, F
-49470X0-395-B-	SM-41C395-H-360	3.9	K, M	BX	4	N, L, M, J, K
-49470X0-475-B-	SM-41C475-H-360	4.7	K, M	BX	4	N, L, M, J, K
-49470X0-565-B-	SM-41C565-H-480	5.6	K, M	BX	4	N, L, M, J, K
-49470X0-685-B-	SM-41C685-H-480	6.8	K, M	BX	4	N, L, M, J, K
-49470X0-825-B-	SM-41C825-H-650	8.2	K, M	BX	4	N, L, M, J, K
-49470X0-825-B-	SM-31C825-H-240	8.2	K, M	BX	3	A, B, D, C, F
-49470X0-106-B-	SM-31C106-H-240	10	K, M	BX	3	N, L, M, J, K
-49470X0-126-B-	SM-31C126-H-240	12	K, M	BX	3	N, L, M, J, K
-49470X0-156-B-	SM-31C156-H-360	15	K, M	BX	3	N, L, M, J, K
-49470X0-186-B-	SM-31C186-H-360	18	K, M	BX	3	N, L, M, J, K
-49470X0-226-B-	SM-31C226-H-480	22	K, M	BX	3	N, L, M, J, K
-49470X0-276-B-	SM-31C276-H-650	27	K, M	BX	3	N, L, M, J, K
-49470X0-276-B-	SM-21C276-H-240	27	K, M	BX	2	A, B, D, C, F
-49470X0-336-B-	SM-11C336-H-360	33	K, M	BX	1	N, L, M, J, K
-49470X0-336-B-	SM-21C336-H-240	33	K, M	BX	2	A, B, D, C, F
-49470X0-396-B-	SM-11C396-H-480	39	K, M	BX	1	N, L, M, J, K
-49470X0-396-B-	SM-21C396-H-360	39	K, M	BX	2	A, B, D, C, F
-49470X0-476-B-	SM-11C476-H-480	47	K, M	BX	1	N, L, M, J, K
-49470X0-476-B-	SM-21C476-H-360	47	K, M	BX	2	A, B, D, C, F
-49470X0-566-B-	SM-11C566-H-650	56	K, M	BX	1	N, L, M, J, K
-49470X0-686-B-	SM-21C686-H-480	68	K, M	BX	2	N, L, M, J, K
-49470X0-826-B-	SM-21C826-H-650	82	K, M	BX	2	N, L, M, J, K
-49470X0-107-B-	SM-61C107-H-360	100	K, M	BX	6	N, L, M, J, K

1/ Complete PIN shall include additional symbols replacing dashes (from left to right): product level (M for B level, or T for T level), part style (1 for unencapsulated, 2 for encapsulated), capacitance tolerance, lead configuration
 2/ Complete AVX Part Number (provided for reference only) shall include additional symbols replacing dashes (from left to right): part style (0 for unencapsulated and 9 for encapsulated), capacitance tolerance, lead configuration
 The last 3 digits of the AVX Part Number represent the chip height of the unencapsulated version. For the encapsulated version, replace the last 3 digits as follows: (120 replace with 270, 240 replace with 390, 360 replace with 530, 480 replace with 660 and 650 replace with 800).



SMPS Stacked MLC Capacitors

SM Style SM Military Styles MIL-PRF-49470



MIL-PRF-49470 PIN 1/	AVX PART NUMBER (for reference only) 2/	Capacitance μ F	Tolerance	Characteristic	Case Code	Lead Configuration
-49470X0-127-B-	SM-61C127-H-360	120	K, M	BX	6	N, L, M, J, K
-49470X0-157-B-	SM-61C157-H-480	150	K, M	BX	6	N, L, M, J, K
-49470X0-187-B-	SM-61C187-H-540	180	K, M	BX	6	N, L, M, J, K
200V						
-49470P0-223-C-	SM-52A223-H-120	0.022	J, K	BP	5	N, L, M, J, K
-49470P0-273-C-	SM-52A273-H-240	0.027	J, K	BP	5	N, L, M, J, K
-49470P0-333-C-	SM-52A333-H-240	0.033	J, K	BP	5	N, L, M, J, K
-49470P0-393-C-	SM-52A393-H-240	0.039	J, K	BP	5	N, L, M, J, K
-49470P0-473-C-	SM-52A473-H-360	0.047	J, K	BP	5	N, L, M, J, K
-49470P0-563-C-	SM-52A563-H-360	0.056	J, K	BP	5	N, L, M, J, K
-49470P0-683-C-	SM-52A683-H-480	0.068	J, K	BP	5	N, L, M, J, K
-49470P0-683-C-	SM-42A683-H-120	0.068	J, K	BP	4	A, B, D, C, F
-49470P0-823-C-	SM-52A823-H-480	0.082	J, K	BP	5	N, L, M, J, K
-49470P0-823-C-	SM-42A823-H-240	0.082	J, K	BP	4	A, B, D, C, F
-49470P0-104-C-	SM-52A104-H-650	0.1	J, K	BP	5	N, L, M, J, K
-49470P0-104-C-	SM-42A104-H-240	0.1	J, K	BP	4	A, B, D, C, F
-49470P0-124-C-	SM-42A124-H-360	0.12	J, K	BP	4	N, L, M, J, K
-49470P0-154-C-	SM-42A154-H-360	0.15	J, K	BP	4	N, L, M, J, K
-49470P0-184-C-	SM-42A184-H-480	0.18	J, K	BP	4	N, L, M, J, K
-49470P0-224-C-	SM-42A224-H-480	0.22	J, K	BP	4	N, L, M, J, K
-49470P0-274-C-	SM-42A274-H-650	0.27	J, K	BP	4	N, L, M, J, K
-49470P0-274-C-	SM-32A274-H-240	0.27	J, K	BP	3	A, B, D, C, F
-49470P0-334-C-	SM-32A334-H-240	0.33	J, K	BP	3	N, L, M, J, K
-49470P0-394-C-	SM-32A394-H-240	0.39	J, K	BP	3	N, L, M, J, K
-49470P0-474-C-	SM-32A474-H-360	0.47	J, K	BP	3	N, L, M, J, K
-49470R0-474-C-	SM-52C474-H-240	0.47	K, M	BR	5	N, L, M, J, K
-49470P0-564-C-	SM-32A564-H-480	0.56	J, K	BP	3	N, L, M, J, K
-49470P0-564-C-	SM-32A564-H-360	0.56	J, K	BP	3	N, L, M, J, K
-49470R0-564-C-	SM-52C564-H-240	0.56	K, M	BR	5	N, L, M, J, K
-49470P0-684-C-	SM-32A684-H-480	0.68	J, K	BP	3	N, L, M, J, K
-49470R0-684-C-	SM-52C684-H-360	0.68	K, M	BR	5	N, L, M, J, K
-49470P0-824-C-	SM-32A824-H-650	0.82	J, K	BP	3	N, L, M, J, K
-49470R0-824-C-	SM-52C824-H-360	0.82	K, M	BR	5	N, L, M, J, K
-49470P0-105-C-	SM-32A105-H-650	1	J, K	BP	3	N, L, M, J, K
-49470R0-105-C-	SM-52C105-H-480	1	K, M	BR	5	N, L, M, J, K
-49470R0-105-C-	SM-42C105-H-120	1	K, M	BR	4	A, B, D, C, F
-49470R0-125-C-	SM-52C125-H-480	1.2	K, M	BR	5	N, L, M, J, K
-49470R0-125-C-	SM-42C125-H-240	1.2	K, M	BR	4	A, B, D, C, F
-49470R0-155-C-	SM-52C155-H-650	1.5	K, M	BR	5	N, L, M, J, K
-49470R0-155-C-	SM-42C155-H-240	1.5	K, M	BR	4	A, B, D, C, F
-49470R0-185-C-	SM-42C185-H-360	1.8	K, M	BR	4	N, L, M, J, K
-49470R0-225-C-	SM-42C225-H-360	2.2	K, M	BR	4	N, L, M, J, K
-49470R0-275-C-	SM-42C275-H-480	2.7	K, M	BR	4	N, L, M, J, K
-49470R0-335-C-	SM-42C335-H-480	3.3	K, M	BR	4	N, L, M, J, K
-49470R0-395-C-	SM-42C395-H-650	3.9	K, M	BR	4	N, L, M, J, K
-49470R0-395-C-	SM-32C395-H-240	3.9	K, M	BR	3	A, B, D, C, F
-49470R0-475-C-	SM-32C475-H-240	4.7	K, M	BR	3	N, L, M, J, K
-49470R0-565-C-	SM-32C565-H-240	5.6	K, M	BR	3	N, L, M, J, K
-49470R0-685-C-	SM-32C685-H-360	6.8	K, M	BR	3	N, L, M, J, K
-49470R0-825-C-	SM-32C825-H-360	8.2	K, M	BR	3	N, L, M, J, K
-49470R0-106-C-	SM-32C106-H-480	10	K, M	BR	3	N, L, M, J, K
-49470R0-126-C-	SM-32C126-H-650	12	K, M	BR	3	N, L, M, J, K
-49470R0-126-C-	SM-22C126-H-240	12	K, M	BR	2	A, B, D, C, F
-49470R0-156-C-	SM-12C156-H-360	15	K, M	BR	1	N, L, M, J, K
-49470R0-156-C-	SM-22C156-H-240	15	K, M	BR	2	A, B, D, C, F
-49470R0-186-C-	SM-12C186-H-480	18	K, M	BR	1	N, L, M, J, K
-49470R0-186-C-	SM-22C186-H-360	18	K, M	BR	2	A, B, D, C, F

1/ Complete PIN shall include additional symbols replacing dashes (from left to right): product level (M for B level, or T for T level), part style (1 for unencapsulated, 2 for encapsulated), capacitance tolerance, lead configuration
 2/ Complete AVX Part Number (provided for reference only) shall include additional symbols replacing dashes (from left to right): part style (0 for unencapsulated and 9 for encapsulated), capacitance tolerance, lead configuration
 The last 3 digits of the AVX Part Number represent the chip height of the unencapsulated version. For the encapsulated version, replace the last 3 digits as follows: (120 replace with 270, 240 replace with 390, 360 replace with 530, 480 replace with 660 and 650 replace with 800).



The Important Information/Disclaimer is incorporated in the catalog where these specifications came from or available online at www.avx.com/disclaimer/ by reference and should be reviewed in full before placing any order.

SMPS Stacked MLC Capacitors

SM Style SM Military Styles MIL-PRF-49470



MIL-PRF-49470 PIN 1/	AVX PART NUMBER (for reference only) 2/	Capacitance μ F	Tolerance	Characteristic	Case Code	Lead Configuration
-49470R0-226-C-	SM-12C226-H-650	22	K, M	BR	1	N, L, M, J, K
-49470R0-226-C-	SM-22C226-H-360	22	K, M	BR	2	A, B, D, C, F
-49470R0-276-C-	SM-12C276-H-650	27	K, M	BR	1	N, L, M, J, K
-49470R0-276-C-	SM-22C276-H-480	27	K, M	BR	2	A, B, D, C, F
-49470R0-336-C-	SM-22C336-H-480	33	K, M	BR	2	N, L, M, J, K
-49470R0-396-C-	SM-22C396-H-650	39	K, M	BR	2	N, L, M, J, K
-49470R0-476-C-	SM-62C476-H-240	47	K, M	BR	6	N, L, M, J, K
-49470R0-566-C-	SM-62C566-H-360	56	K, M	BR	6	N, L, M, J, K
-49470R0-686-C-	SM-62C686-H-360	68	K, M	BR	6	N, L, M, J, K
-49470R0-826-C-	SM-62C826-H-480	82	K, M	BR	6	N, L, M, J, K
-49470R0-107-C-	SM-62C107-H-650	100	K, M	BR	6	N, L, M, J, K
-49470R0-127-C-	SM-62C127-H-650	120	K, M	BR	6	N, L, M, J, K
500V						
-49470P0-103-E-	SM-57A103-H-120	0.01	J, K	BP	5	N, L, M, J, K
-49470P0-123-E-	SM-57A123-H-240	0.012	J, K	BP	5	N, L, M, J, K
-49470P0-153-E-	SM-57A153-H-240	0.015	J, K	BP	5	N, L, M, J, K
-49470P0-183-E-	SM-57A183-H-240	0.018	J, K	BP	5	N, L, M, J, K
-49470P0-223-E-	SM-57A223-H-360	0.022	J, K	BP	5	N, L, M, J, K
-49470P0-273-E-	SM-57A273-H-360	0.027	J, K	BP	5	N, L, M, J, K
-49470P0-333-E-	SM-57A333-H-480	0.033	J, K	BP	5	N, L, M, J, K
-49470P0-333-E-	SM-47A333-H-240	0.033	J, K	BP	4	A, B, C, D, F
-49470P0-393-E-	SM-57A393-H-480	0.039	J, K	BP	5	N, L, M, J, K
-49470P0-393-E-	SM-47A393-H-240	0.039	J, K	BP	4	A, B, C, D, F
-49470P0-473-E-	SM-57A473-H-650	0.047	J, K	BP	5	N, L, M, J, K
-49470P0-473-E-	SM-47A473-H-360	0.047	J, K	BP	4	A, B, C, D, F
-49470P0-563-E-	SM-47A563-H-360	0.056	J, K	BP	4	N, L, M, J, K
-49470P0-683-E-	SM-47A683-H-360	0.068	J, K	BP	4	N, L, M, J, K
-49470P0-823-E-	SM-47A823-H-480	0.082	J, K	BP	4	N, L, M, J, K
-49470P0-104-E-	SM-47A104-H-480	0.1	J, K	BP	4	N, L, M, J, K
-49470P0-124-E-	SM-47A124-H-650	0.12	J, K	BP	4	N, L, M, J, K
-49470P0-124-E-	SM-37A124-H-240	0.12	J, K	BP	3	A, B, C, D, F
-49470P0-154-E-	SM-37A154-H-240	0.15	J, K	BP	3	N, L, M, J, K
-49470Q0-154-E-	SM-57C154-H-120	0.15	K, M	BQ	5	N, L, M, J, K
-49470P0-184-E-	SM-37A184-H-240	0.18	J, K	BP	3	N, L, M, J, K
-49470Q0-184-E-	SM-57C184-H-240	0.18	K, M	BQ	5	N, L, M, J, K
-49470P0-224-E-	SM-37A224-H-360	0.22	J, K	BP	3	N, L, M, J, K
-49470Q0-224-E-	SM-57C224-H-240	0.22	K, M	BQ	5	N, L, M, J, K
-49470P0-274-E-	SM-37A274-H-360	0.27	J, K	BP	3	N, L, M, J, K
-49470Q0-274-E-	SM-57C274-H-240	0.27	K, M	BQ	5	N, L, M, J, K
-49470P0-334-E-	SM-37A334-H-480	0.33	J, K	BP	3	N, L, M, J, K
-49470Q0-334-E-	SM-57C334-H-360	0.33	K, M	BQ	5	N, L, M, J, K
-49470P0-394-E-	SM-37A394-H-650	0.39	J, K	BP	3	N, L, M, J, K
-49470Q0-394-E-	SM-57C394-H-360	0.39	K, M	BQ	5	N, L, M, J, K
-49470Q0-474-E-	SM-57C474-H-360	0.47	K, M	BQ	5	N, L, M, J, K
-49470Q0-564-E-	SM-57C564-H-480	0.56	K, M	BQ	5	N, L, M, J, K
-49470Q0-564-E-	SM-47C564-H-240	0.56	K, M	BQ	4	A, B, D, C, F
-49470Q0-684-E-	SM-57C684-H-650	0.68	K, M	BQ	5	N, L, M, J, K
-49470Q0-684-E-	SM-47C684-H-240	0.68	K, M	BQ	4	A, B, D, C, F
-49470Q0-824-E-	SM-47C824-H-360	0.82	K, M	BQ	4	N, L, M, J, K
-49470Q0-105-E-	SM-47C105-H-360	1	K, M	BQ	4	N, L, M, J, K
-49470Q0-125-E-	SM-47C125-H-360	1.2	K, M	BQ	4	N, L, M, J, K
-49470Q0-155-E-	SM-47C155-H-480	1.5	K, M	BQ	4	N, L, M, J, K
-49470Q0-185-E-	SM-47C185-H-650	1.8	K, M	BQ	4	N, L, M, J, K
-49470Q0-185-E-	SM-37C185-H-240	1.8	K, M	BQ	3	A, B, D, C, F
-49470Q0-225-E-	SM-37C225-H-240	2.2	K, M	BQ	3	N, L, M, J, K
-49470Q0-275-E-	SM-37C275-H-360	2.7	K, M	BQ	3	N, L, M, J, K
-49470Q0-335-E-	SM-37C335-H-360	3.3	K, M	BQ	3	N, L, M, J, K

1/ Complete PIN shall include additional symbols replacing dashes (from left to right): product level (M for B level, or T for T level), part style (1 for unencapsulated, 2 for encapsulated), capacitance tolerance, lead configuration
 2/ Complete AVX Part Number (provided for reference only) shall include additional symbols replacing dashes (from left to right): part style (0 for unencapsulated and 9 for encapsulated), capacitance tolerance, lead configuration
 The last 3 digits of the AVX Part Number represent the chip height of the unencapsulated version. For the encapsulated version, replace the last 3 digits as follows: (120 replace with 270, 240 replace with 390, 360 replace with 530, 480 replace with 660 and 650 replace with 800).



SMPS Stacked MLC Capacitors

SM Style SM Military Styles MIL-PRF-49470



MIL-PRF-49470 PIN 1/	AVX PART NUMBER (for reference only) 2/	Capacitance μ F	Tolerance	Characteristic	Case Code	Lead Configuration
-49470Q0-395-E-	SM-37C395-H-360	3.9	K, M	BQ	3	N, L, M, J, K
-49470Q0-475-E-	SM-37C475-H-480	4.7	K, M	BQ	3	N, L, M, J, K
-49470Q0-565-E-	SM-37C565-H-650	5.6	K, M	BQ	3	N, L, M, J, K
-49470Q0-565-E-	SM-27C565-H-240	5.6	K, M	BQ	2	A, B, D, C, F
-49470Q0-685-E-	SM-17C685-H-480	6.8	K, M	BQ	1	N, L, M, J, K
-49470Q0-685-E-	SM-27C685-H-240	6.8	K, M	BQ	2	A, B, D, C, F
-49470Q0-825-E-	SM-17C825-H-480	8.2	K, M	BQ	1	N, L, M, J, K
-49470Q0-825-E-	SM-27C825-H-360	8.2	K, M	BQ	2	A, B, D, C, F
-49470Q0-106-E-	SM-17C106-H-480	10	K, M	BQ	1	N, L, M, J, K
-49470Q0-106-E-	SM-27C106-H-360	10	K, M	BQ	2	A, B, D, C, F
-49470Q0-126-E-	SM-17C126-H-650	12	K, M	BQ	1	N, L, M, J, K
-49470Q0-126-E-	SM-27C126-H-480	12	K, M	BQ	2	A, B, D, C, F
-49470Q0-156-E-	SM-27C156-H-650	15	K, M	BQ	2	N, L, M, J, K
-49470Q0-186-E-	SM-27C186-H-650	18	K, M	BQ	2	N, L, M, J, K
-49470Q0-226-E-	SM-67C226-H-360	22	K, M	BQ	6	N, L, M, J, K
-49470Q0-276-E-	SM-67C276-H-360	27	K, M	BQ	6	N, L, M, J, K
-49470Q0-336-E-	SM-67C336-H-480	33	K, M	BQ	6	N, L, M, J, K
-49470Q0-396-E-	SM-67C396-H-650	39	K, M	BQ	6	N, L, M, J, K

- 1/ Complete PIN shall include additional symbols replacing dashes (from left to right): product level (M for B level, or T for T level), part style (1 for unencapsulated, 2 for encapsulated), capacitance tolerance, lead configuration
- 2/ Complete AVX Part Number (provided for reference only) shall include additional symbols replacing dashes (from left to right): part style (0 for unencapsulated and 9 for encapsulated), capacitance tolerance, lead configuration
- The last 3 digits of the AVX Part Number represent the chip height of the unencapsulated version. For the encapsulated version, replace the last 3 digits as follows: (120 replace with 270, 240 replace with 390, 360 replace with 530, 480 replace with 660 and 650 replace with 800).

SMPS Stacked MLC Capacitors

SM Style SM Military Styles DSCC Dwg. #87106 & #88011

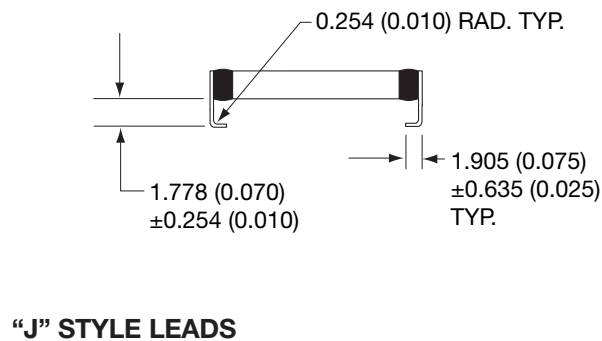
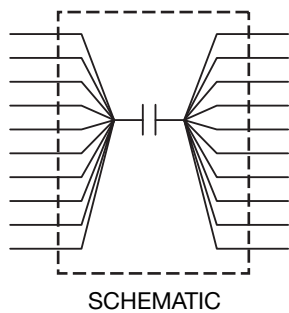
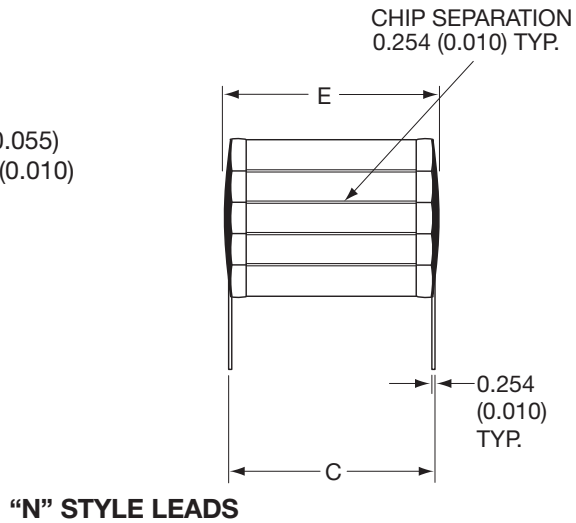
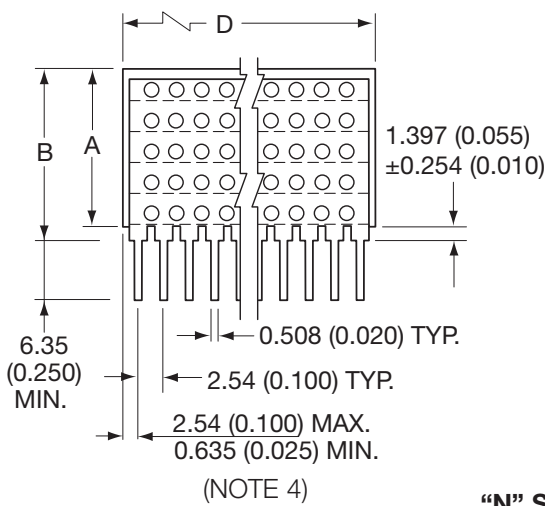

DIMENSIONS:

millimeters (inches)

Case Code	A (max.) (See Note 2)	B (max.) (See Note 2)	C ±.635 (±0.025)	D ±.635 (±0.025)	E (max.)	No. of Leads per side
1	16.5 (0.650)	18.2 (0.715)	11.4 (0.450)	52.1 (2.050)	12.7 (0.500)	20
2	16.5 (0.650)	18.2 (0.715)	20.3 (0.800)	38.4 (1.510)	22.1 (0.870)	15
3	16.5 (0.650)	18.2 (0.715)	11.4 (0.450)	26.7 (1.050)	12.7 (0.500)	10
4	16.5 (0.650)	18.2 (0.715)	10.2 (0.400)	10.2 (0.400)	11.2 (0.440)	4
5	16.5 (0.650)	18.2 (0.715)	6.35 (0.250)	6.35 (0.250)	7.62 (0.300)	3
6	16.5 (0.650)	18.2 (0.715)	31.8 (1.250)	52.1 (2.050)	34.3 (1.350)	20

NOTES:

1. Unless otherwise specified, tolerances 0.254 (±0.010).
2. “A” dimensions are maximum (see tables on pages 26 thru 29 for specific part number dimensions).
3. “N” straight leads; “J” leads formed in.
4. For case code 5, dimensions shall be 2.54 (0.100) maximum, 0.305 (0.012) minimum.

SMPS Stacked MLC Capacitors

SM Style SM Military Styles DSCC Dwg. #87106 & #88011



Ordering Information

Part Number: The complete part number shall be as follows:

X7R: 87106

XXX

Drawing number

Dash number
(see list)

Ordering Data. The contract or purchase order should specify the following:

- Complete part number.
- Requirements for delivery of one copy of the quality conformance inspection data with each shipment of parts by the manufacturer.
- Whether the manufacturer performs the group B tests, or provides certification of compliance with group B requirements.
- Requirements for notification of change of products to acquiring activity, if applicable.
- Requirements for packaging and packing.

Source of Supply.

Vendor CAGE number	Vendor name and address
Contact factory	AVX Corporation

Performance Characteristics

Operating Temperature Range. The operating temperature range shall be -55°C to +125°C.

Electrical Characteristics.

Rated Voltage. See tables on pages 26-29.

Capacitance. Measured in accordance with method 305 of MIL-STD-202 (1KHz at 1.0Vrms, open circuit voltage, at +25°C).

Dissipation Factor (+25°C). X7R: Dissipation factor shall be 2.5 percent maximum (measured under the same conditions as capacitance.) COG: Dissipation factor shall be 0.15 percent maximum.

Temperature Coefficient.

DSCC Dwg.		Bias = 0 volt	Bias = rated voltage
88011	All Voltages	0±30 ppm/°C	0±30 ppm/°C
87106	50 WVDC and 100 WVDC	±15%	+15, -25%
87106	200 WVDC	±15%	+15, -40%
87106	500 WVDC	±15%	+15, -50%

Insulation Resistance.

At +25°C, rated voltage: 100K MΩ or 1,000 MΩ-μF, whichever is less.

At +125°C, rated voltage: 10K MΩ or 100 MΩ-μF, whichever is less.

Dielectric Withstanding Voltage. Dielectric withstanding voltage shall be 250 percent of rated voltage except 500V rated parts at 150 percent of rated voltage.

Capacitance Tolerance. J = ±5 percent, K = ±10 percent, M = ±20 percent.

Solderability of Terminals. In accordance with MIL-PRF-49470.

Resistance to Soldering Heat. In accordance with MIL-STD-202, method 210, condition B, for 20 seconds.

Shock. In accordance with MIL-PRF-49470.

Immersion Cycling. In accordance with MIL-PRF-49470.

Moisture Resistance. In accordance with MIL-PRF-49470.

Life. Life shall be 200 percent of rated voltage except 500V rated parts at 120 percent of rated voltage applied at +125°C for 1,000 hours.

Thermal Shock. MIL-STD-202, method 107, test condition A, except high temperature is +125°C.

Voltage Conditioning. In accordance with MIL-PRF-49470, except 500V rated parts at 120 percent of rated voltage at +125°C.

Terminal Strength. MIL-STD-202, method 211, condition B, except that each lead shall be bent away from the body 90 degrees from the original position and back, two bends.

Marking. Marking shall be in accordance with MIL-STD-1285, except the part number shall be as specified in paragraph 1.2 of 87106, or 88011 with the manufacturer's name or code and date code minimum, except case sizes 4 and 5 shall be marked with coded cap and tolerance minimum. Full marking shall be included on the package.



SMPS Stacked MLC Capacitors

SM Style DSCC #87106 and #88011



Table II. Group A inspection.

Inspection	Requirement paragraph of MIL-PRF-49470	Test method paragraph of MIL-PRF-49470	Sampling procedure
Subgroup 1 Thermal shock and voltage conditioning 1/	3.9	4.8.5	100% inspection
Subgroup 2 Visual and mechanical examination: Material Physical dimensions Interface requirements (other than physical dimensions) Marking 2/ Workmanship	3.4 3.1 3.5 and 3.5.1 3.28 3.30	4.8.4	13 samples 0 failures

1/ Post checks are required (see paragraph 3.9 of MIL-PRF-49470).

2/ Marking defects are based on visual examination only. Any subsequent electrical defects shall not be used as a basis for determining marking defects.

Table III. Group B inspection. 1/

Inspection	Requirement paragraph of MIL-PRF-49470	Test method paragraph of MIL-PRF-49470	Number of sample units to be inspected	Number of defectives permitted 2/	
Subgroup 1 3/ Temperature coefficient Resistance to solvents 5/ 6/ Immersion Terminal strength 5/	4/ 3.23 3.18 3.24	4/ 4.8.20 4.8.15 4.8.10	12	1	6/ 1
Subgroup 2 Resistance to soldering heat Moisture resistance	3.20 3.21	4.8.17 4.8.18	12	1	
Subgroup 3 Marking legibility (laser marking only)	3.28.1	4.8.4.1	6	1	
Subgroup 4 Solderability Subgroup 5 Life	3.15 3.26	4.8.12 4.8.22	3 5 minimum per case code	0 0	

1/ 1/ Unless otherwise specified herein, when necessary, mounting of group B samples shall be at the discretion of the manufacturer.

2/ A sample unit having one or more defects shall be charged as a single defective.

3/ Order of tests is at discretion of manufacturer.

4/ See 3.2.3 of DSCC 87106.

5/ Sample size shall be 3 pieces with zero defectives permitted.

6/ Total of one defect allowed for combination of subgroup 1, subgroup 2, and subgroup 3 inspections.

SMPS Stacked MLC Capacitors

SM Style SM Military Styles DSCC Dwg. #87106 (X7R)



Electrical characteristics

DSCC Dwg. 87106-	Cap. Value (µF)	Cap. Tol.	Case Code	Lead Style	Max. A Dimension mm (inches)
50V					
001	1.0	K	5	N	3.05 (0.120)
002	1.0	M	5	N	3.05 (0.120)
241	1.0	K	5	J	3.05 (0.120)
242	1.0	M	5	J	3.05 (0.120)
003	1.2	K	5	N	3.05 (0.120)
004	1.2	M	5	N	3.05 (0.120)
243	1.2	K	5	J	3.05 (0.120)
244	1.2	M	5	J	3.05 (0.120)
005	1.5	K	5	N	6.10 (0.240)
006	1.5	M	5	N	6.10 (0.240)
245	1.5	K	5	J	6.10 (0.240)
246	1.5	M	5	J	6.10 (0.240)
007	1.8	K	5	N	6.10 (0.240)
008	1.8	M	5	N	6.10 (0.240)
247	1.8	K	5	J	6.10 (0.240)
248	1.8	M	5	J	6.10 (0.240)
009	2.2	K	5	N	6.10 (0.240)
010	2.2	M	5	N	6.10 (0.240)
249	2.2	K	5	J	6.10 (0.240)
250	2.2	M	5	J	6.10 (0.240)
011	2.7	K	5	N	9.14 (0.360)
012	2.7	M	5	N	9.14 (0.360)
251	2.7	K	5	J	9.14 (0.360)
252	2.7	M	5	J	9.14 (0.360)
013	3.3	K	5	N	9.14 (0.360)
014	3.3	M	5	N	9.14 (0.360)
253	3.3	K	5	J	9.14 (0.360)
254	3.3	M	5	J	9.14 (0.360)
015	3.9	K	5	N	12.2 (0.480)
016	3.9	M	5	N	12.2 (0.480)
255	3.9	K	5	J	12.2 (0.480)
256	3.9	M	5	J	12.2 (0.480)
017	4.7	K	5	N	12.2 (0.480)
018	4.7	M	5	N	12.2 (0.480)
257	4.7	K	5	J	12.2 (0.480)
258	4.7	M	5	J	12.2 (0.480)
019	5.6	K	5	N	16.5 (0.650)
020	5.6	M	5	N	16.5 (0.650)
259	5.6	K	5	J	16.5 (0.650)
260	5.6	M	5	J	16.5 (0.650)
223	6.8	K	4	N	9.14 (0.360)
224	6.8	M	4	N	9.14 (0.360)
261	6.8	K	4	J	9.14 (0.360)
262	6.8	M	4	J	9.14 (0.360)
021	8.2	K	4	N	9.14 (0.360)
022	8.2	M	4	N	9.14 (0.360)
263	8.2	K	4	J	9.14 (0.360)
264	8.2	M	4	J	9.14 (0.360)
023	10	K	4	N	12.2 (0.480)
024	10	M	4	N	12.2 (0.480)
265	10	K	4	J	12.2 (0.480)
266	10	M	4	J	12.2 (0.480)
025	12	K	4	N	12.2 (0.480)
026	12	M	4	N	12.2 (0.480)
267	12	K	4	J	12.2 (0.480)
268	12	M	4	J	12.2 (0.480)
027	15	K	4	N	16.5 (0.650)
028	15	M	4	N	16.5 (0.650)
269	15	K	4	J	16.5 (0.650)
270	15	M	4	J	16.5 (0.650)
029	18	K	3	N	6.10 (0.240)
030	18	M	3	N	6.10 (0.240)
271	18	K	3	J	6.10 (0.240)

DSCC Dwg. 87106-	Cap. Value (µF)	Cap. Tol.	Case Code	Lead Style	Max. A Dimension mm (inches)
50V					
272	18	M	3	J	6.10 (0.240)
272	18	M	3	J	6.10 (0.240)
031	22	K	3	N	9.14 (0.360)
032	22	M	3	N	9.14 (0.360)
273	22	K	3	J	9.14 (0.360)
274	22	M	3	J	9.14 (0.360)
033	27	K	3	N	9.14 (0.360)
034	27	M	3	N	9.14 (0.360)
275	27	K	3	J	9.14 (0.360)
276	27	M	3	J	9.14 (0.360)
035	33	K	3	N	9.14 (0.360)
036	33	M	3	N	9.14 (0.360)
277	33	K	3	J	9.14 (0.360)
278	33	M	3	J	9.14 (0.360)
037	39	K	3	N	12.2 (0.480)
038	39	M	3	N	12.2 (0.480)
279	39	K	3	J	12.2 (0.480)
280	39	M	3	J	12.2 (0.480)
039	47	K	3	N	16.5 (0.650)
040	47	M	3	N	16.5 (0.650)
281	47	K	3	J	16.5 (0.650)
282	47	M	3	J	16.5 (0.650)
225	56	K	1	N	9.14 (0.360)
226	56	M	1	N	9.14 (0.360)
283	56	K	1	J	9.14 (0.360)
284	56	M	1	J	9.14 (0.360)
041	68	K	1	N	12.2 (0.480)
042	68	M	1	N	12.2 (0.480)
285	68	K	1	J	12.2 (0.480)
286	68	M	1	J	12.2 (0.480)
043	82	K	1	N	12.2 (0.480)
044	82	M	1	N	12.2 (0.480)
287	82	K	1	J	12.2 (0.480)
288	82	M	1	J	12.2 (0.480)
045	100	K	1	N	16.5 (0.650)
046	100	M	1	N	16.5 (0.650)
289	100	K	1	J	16.5 (0.650)
290	100	M	1	J	16.5 (0.650)
227	120	K	2	N	12.2 (0.480)
228	120	M	2	N	12.2 (0.480)
291	120	K	2	J	12.2 (0.480)
292	120	M	2	J	12.2 (0.480)
047	150	K	2	N	16.5 (0.650)
048	150	M	2	N	16.5 (0.650)
293	150	K	2	J	16.5 (0.650)
294	150	M	2	J	16.5 (0.650)
049	180	K	6	N	12.2 (0.480)
050	180	M	6	N	12.2 (0.480)
295	180	K	6	J	12.2 (0.480)
296	180	M	6	J	12.2 (0.480)
051	220	K	6	N	12.2 (0.480)
052	220	M	6	N	12.2 (0.480)
297	220	K	6	J	12.2 (0.480)
298	220	M	6	J	12.2 (0.480)
053	270	K	6	N	16.5 (0.650)
054	270	M	6	N	16.5 (0.650)
299	270	K	6	J	16.5 (0.650)
300	270	M	6	J	16.5 (0.650)

DSCC Dwg. 87106-	Cap. Value (µF)	Cap. Tol.	Case Code	Lead Style	Max. A Dimension mm (inches)
100V					
055	.68	K	5	N	3.05 (0.120)
056	.68	M	5	N	3.05 (0.120)
301	.68	K	5	J	3.05 (0.120)
302	.68	M	5	J	3.05 (0.120)
057	.82	K	5	N	6.10 (0.240)
058	.82	M	5	N	6.10 (0.240)
303	.82	K	5	J	6.10 (0.240)
304	.82	M	5	J	6.10 (0.240)
059	1.0	K	5	N	6.10 (0.240)
060	1.0	M	5	N	6.10 (0.240)
305	1.0	K	5	J	6.10 (0.240)
306	1.0	M	5	J	6.10 (0.240)
061	1.2	K	5	N	6.10 (0.240)
062	1.2	M	5	N	6.10 (0.240)
307	1.2	K	5	J	6.10 (0.240)
308	1.2	M	5	J	6.10 (0.240)
063	1.5	K	5	N	9.14 (0.360)
064	1.5	M	5	N	9.14 (0.360)
309	1.5	K	5	J	9.14 (0.360)
310	1.5	M	5	J	9.14 (0.360)
065	1.8	K	5	N	9.14 (0.360)
066	1.8	M	5	N	9.14 (0.360)
311	1.8	K	5	J	9.14 (0.360)
312	1.8	M	5	J	9.14 (0.360)
067	2.2	K	5	N	12.2 (0.480)
068	2.2	M	5	N	12.2 (0.480)
313	2.2	K	5	J	12.2 (0.480)
314	2.2	M	5	J	12.2 (0.480)
069	2.7	K	5	N	12.2 (0.480)
070	2.7	M	5	N	12.2 (0.480)
315	2.7	K	5	J	12.2 (0.480)
316	2.7	M	5	J	12.2 (0.480)
071	3.3	K	5	N	16.5 (0.650)
072	3.3	M	5	N	16.5 (0.650)
317	3.3	K	5	J	16.5 (0.650)
318	3.3	M	5	J	16.5 (0.650)
073	3.9	K	4	N	9.14 (0.360)
074	3.9	M	4	N	9.14 (0.360)
319	3.9	K	4	J	9.14 (0.360)
320	3.9	M	4	J	9.14 (0.360)
075	4.7	K	4	N	9.14 (0.360)
076	4.7	M	4	N	9.14 (0.360)
321	4.7	K	4	J	9.14 (0.360)
322	4.7	M	4	J	9.14 (0.360)
077	5.6	K	4	N	12.2 (0.480)
078	5.6	M	4	N	12.2 (0.480)
323	5.6	K	4	J	12.2 (0.480)
324	5.6	M	4	J	12.2 (0.480)
079	6.8	K	4	N	12.2 (0.480)
080	6.8	M	4	N	12.2 (0.480)
325	6.8	K	4	J	12.2 (0.480)
326	6.8	M	4	J	12.2 (0.480)
081	8.2	K	4	N	16.5 (0.650)
082	8.2	M	4	N	16.5 (0.650)
327	8.2	K	4	J	16.5 (0.650)
328	8.2	M	4	J	16.5 (0.650)
229	10	K	3	N	6.10 (0.240)
230	10	M	3	N	6.10 (0.240)
329	10	K	3	J	6.10 (0.240)
330	10	M	3	J	6.10 (0.240)
083	12	K	3	N	6.10 (0.240)
084	12	M	3	N	6.10 (0.240)
331	12	K	3	J	6.10 (0.240)
332	12	M	3	J	6.10 (0.240)

SMPS Stacked MLC Capacitors

SM Style SM Military Styles DSCC Dwg. #87106 (X7R)



DSCC Dwg. 87106-	Cap. Value (µF)	Cap. Tol.	Case Code	Lead Style	Max. A Dimension mm (inches)
100V					
085	15	K	3	N	9.14 (0.360)
086	15	M	3	N	9.14 (0.360)
333	15	K	3	J	9.14 (0.360)
334	15	M	3	J	9.14 (0.360)
087	18	K	3	N	9.14 (0.360)
088	18	M	3	N	9.14 (0.360)
335	18	K	3	J	9.14 (0.360)
336	18	M	3	J	9.14 (0.360)
089	22	K	3	N	12.2 (0.480)
090	22	M	3	N	12.2 (0.480)
337	22	M	3	K	12.2 (0.480)
338	22	M	3	J	12.2 (0.480)
091	27	K	3	N	16.5 (0.650)
092	27	M	3	N	16.5 (0.650)
339	27	K	3	J	16.5 (0.650)
340	27	M	3	J	16.5 (0.650)
093	33	K	1	N	9.14 (0.360)
094	33	M	1	N	9.14 (0.360)
341	33	K	1	J	9.14 (0.360)
342	33	M	1	J	9.14 (0.360)
095	39	K	1	N	12.2 (0.480)
096	39	M	1	N	12.2 (0.480)
343	39	K	1	J	12.2 (0.480)
344	39	M	1	J	12.2 (0.480)
097	47	K	1	N	12.2 (0.480)
098	47	M	1	N	12.2 (0.480)
345	47	K	1	J	12.2 (0.480)
346	47	M	1	J	12.2 (0.480)
099	56	K	1	N	16.5 (0.650)
100	56	M	1	N	16.5 (0.650)
347	56	K	1	J	16.5 (0.650)
348	56	M	1	J	16.5 (0.650)
101	68	K	2	N	12.2 (0.480)
102	68	M	2	N	12.2 (0.480)
349	68	K	2	J	12.2 (0.480)
350	68	M	2	J	12.2 (0.480)
103	82	K	2	N	16.5 (0.650)
104	82	M	2	N	16.5 (0.650)
351	82	K	2	J	16.5 (0.650)
352	82	M	2	J	16.5 (0.650)
105	100	K	6	N	9.14 (0.360)
106	100	M	6	N	9.14 (0.360)
353	100	K	6	J	9.14 (0.360)
354	100	M	6	J	9.14 (0.360)
107	120	K	6	N	9.14 (0.360)
108	120	M	6	N	9.14 (0.360)
355	120	K	6	J	9.14 (0.360)
356	120	M	6	J	9.14 (0.360)
109	150	K	6	N	12.2 (0.480)
110	150	M	6	N	12.2 (0.480)
357	150	K	6	J	12.2 (0.480)
358	150	M	6	J	12.2 (0.480)
111	180	K	6	N	16.5 (0.650)
112	180	M	6	N	16.5 (0.650)
359	180	K	6	J	16.5 (0.650)
360	180	M	6	J	16.5 (0.650)
299	270	K	6	J	16.5 (0.650)
300	270	M	6	J	16.5 (0.650)

DSCC Dwg. 87106-	Cap. Value (µF)	Cap. Tol.	Case Code	Lead Style	Max. A Dimension mm (inches)
200V					
113	.47	K	5	N	6.10 (0.240)
114	.47	M	5	N	6.10 (0.240)
361	.47	K	5	J	6.10 (0.240)
362	.47	M	5	J	6.10 (0.240)
115	.56	K	5	N	6.10 (0.240)
116	.56	M	5	N	6.10 (0.240)
363	.56	K	5	J	6.10 (0.240)
364	.56	M	5	J	6.10 (0.240)
117	.68	K	5	N	9.14 (0.360)
118	.68	M	5	N	9.14 (0.360)
365	.68	K	5	J	9.14 (0.360)
366	.68	M	5	J	9.14 (0.360)
119	.82	K	5	N	9.14 (0.360)
120	.82	M	5	N	9.14 (0.360)
367	.82	M	5	J	9.14 (0.360)
368	.82	M	5	J	9.14 (0.360)
121	1.0	K	5	N	12.2 (0.480)
122	1.0	M	5	N	12.2 (0.480)
369	1.0	K	5	J	12.2 (0.480)
370	1.0	M	5	J	12.2 (0.480)
123	1.2	K	5	N	12.2 (0.480)
124	1.2	M	5	N	12.2 (0.480)
371	1.2	K	5	J	12.2 (0.480)
372	1.2	M	5	J	12.2 (0.480)
125	1.5	K	5	N	16.5 (0.650)
126	1.5	M	5	N	16.5 (0.650)
373	1.5	K	5	J	16.5 (0.650)
374	1.5	M	5	J	16.5 (0.650)
127	1.8	K	4	N	9.14 (0.360)
128	1.8	M	4	N	9.14 (0.360)
375	1.8	K	4	J	9.14 (0.360)
376	1.8	M	4	J	9.14 (0.360)
129	2.2	K	4	N	9.14 (0.360)
130	2.2	M	4	N	9.14 (0.360)
377	2.2	K	4	J	9.14 (0.360)
378	2.2	M	4	J	9.14 (0.360)
131	2.7	K	4	N	12.2 (0.480)
132	2.7	M	4	N	12.2 (0.480)
379	2.7	K	4	J	12.2 (0.480)
380	2.7	M	4	J	12.2 (0.480)
133	3.3	K	4	N	12.2 (0.480)
134	3.3	M	4	N	12.2 (0.480)
381	3.3	K	4	J	12.2 (0.480)
382	3.3	M	4	J	12.2 (0.480)
135	3.9	K	4	N	16.5 (0.650)
136	3.9	M	4	N	16.5 (0.650)
383	3.9	K	4	J	16.5 (0.650)
384	3.9	M	4	J	16.5 (0.650)
137	4.7	K	3	N	6.10 (0.240)
138	4.7	M	3	N	6.10 (0.240)
385	4.7	K	3	J	6.10 (0.240)
386	4.7	M	3	J	6.10 (0.240)
139	5.6	K	3	N	6.10 (0.240)
140	5.6	M	3	N	6.10 (0.240)
387	5.6	K	3	J	6.10 (0.240)
388	5.6	M	3	J	6.10 (0.240)
141	6.8	K	3	N	9.14 (0.360)
142	6.8	M	3	N	9.14 (0.360)
389	6.8	K	3	J	9.14 (0.360)
390	6.8	M	3	J	9.14 (0.360)
143	8.2	K	3	N	9.14 (0.360)
144	8.2	M	3	N	9.14 (0.360)
391	8.2	K	3	J	9.14 (0.360)
392	8.2	M	3	J	9.14 (0.360)

DSCC Dwg. 87106-	Cap. Value (µF)	Cap. Tol.	Case Code	Lead Style	Max. A Dimension mm (inches)
200V					
145	10	K	3	N	12.2 (0.480)
146	10	M	3	N	12.2 (0.480)
393	10	K	3	J	12.2 (0.480)
394	10	M	3	J	12.2 (0.480)
147	12	K	3	N	16.5 (0.650)
148	12	M	3	N	16.5 (0.650)
395	12	K	3	J	16.5 (0.650)
396	12	M	3	J	16.5 (0.650)
149	15	K	1	N	9.14 (0.360)
150	15	M	1	N	9.14 (0.360)
397	15	K	1	J	9.14 (0.360)
398	15	M	1	J	9.14 (0.360)
151	18	K	1	N	12.2 (0.480)
152	18	M	1	N	12.2 (0.480)
399	18	K	1	J	12.2 (0.480)
400	18	M	1	J	12.2 (0.480)
153	22	K	1	N	16.5 (0.650)
154	22	M	1	N	16.5 (0.650)
401	22	K	1	J	16.5 (0.650)
402	22	M	1	J	16.5 (0.650)
155	27	K	1	N	16.5 (0.650)
156	27	M	1	N	16.5 (0.650)
403	27	K	1	J	16.5 (0.650)
404	27	M	1	J	16.5 (0.650)
157	33	K	2	N	12.2 (0.480)
158	33	M	2	N	12.2 (0.480)
405	33	K	2	J	12.2 (0.480)
406	33	M	2	J	12.2 (0.480)
159	39	K	2	N	16.5 (0.650)
160	39	M	2	N	16.5 (0.650)
407	39	K	2	J	16.5 (0.650)
408	39	M	2	J	16.5 (0.650)
161	47	K	6	N	6.10 (0.240)
162	47	M	6	N	6.10 (0.240)
409	47	K	6	J	6.10 (0.240)
410	47	M	6	J	6.10 (0.240)
163	56	K	6	N	9.14 (0.360)
164	56	M	6	N	9.14 (0.360)
411	56	K	6	J	9.14 (0.360)
412	56	M	6	J	9.14 (0.360)
165	68	K	6	N	9.14 (0.360)
166	68	M	6	N	9.14 (0.360)
413	68	K	6	J	9.14 (0.360)
414	68	M	6	J	9.14 (0.360)
167	82	K	6	N	12.2 (0.480)
168	82	M	6	N	12.2 (0.480)
415	82	K	6	J	12.2 (0.480)
416	82	M	6	J	12.2 (0.480)
169	100	K	6	N	16.5 (0.650)
170	100	M	6	N	16.5 (0.650)
417	100	K	6	J	16.5 (0.650)
418	100	M	6	J	16.5 (0.650)
171	120	K	6	N	16.5 (0.650)
172	120	M	6	N	16.5 (0.650)
419	120	K	6	J	16.5 (0.650)
420	120	M	6	J	16.5 (0.650)

SMPS Stacked MLC Capacitors

SM Style SM Military Styles DSCC Dwg. #87106 (X7R)

Electrical characteristics

DSCC Dwg. 87106-	Cap. Value (μF)	Cap. Tol.	Case Code	Lead Style	Max. A Dimension mm (inches)
500V					
173	.15	K	5	N	3.05 (0.120)
174	.15	M	5	N	3.05 (0.120)
421	.15	K	5	J	3.05 (0.120)
422	.15	M	5	J	3.05 (0.120)
175	.18	K	5	N	6.10 (0.240)
176	.18	M	5	N	6.10 (0.240)
423	.18	K	5	J	6.10 (0.240)
424	.18	M	5	J	6.10 (0.240)
177	.22	K	5	N	6.10 (0.240)
178	.22	M	5	N	6.10 (0.240)
425	.22	K	5	J	6.10 (0.240)
426	.22	M	5	J	6.10 (0.240)
179	.27	K	5	N	6.10 (0.240)
180	.27	M	5	N	6.10 (0.240)
427	.27	K	5	J	6.10 (0.240)
428	.27	M	5	J	6.10 (0.240)
181	.33	K	5	N	9.14 (0.360)
182	.33	M	5	N	9.14 (0.360)
429	.33	K	5	J	9.14 (0.360)
430	.33	M	5	J	9.14 (0.360)
183	.39	K	5	N	9.14 (0.360)
184	.39	M	5	N	9.14 (0.360)
431	.39	K	5	J	9.14 (0.360)
432	.39	M	5	J	9.14 (0.360)
185	.47	K	5	N	9.14 (0.360)
186	.47	M	5	N	9.14 (0.360)
433	.47	K	5	J	9.14 (0.360)
434	.47	M	5	J	9.14 (0.360)
187	.56	K	5	N	12.2 (0.480)
188	.56	M	5	N	12.2 (0.480)
435	.56	K	5	J	12.2 (0.480)
436	.56	M	5	J	12.2 (0.480)
189	.68	K	5	N	16.5 (0.650)
190	.68	M	5	N	16.5 (0.650)
437	.68	K	5	J	16.5 (0.650)
438	.68	M	5	J	16.5 (0.650)
231	.82	K	4	N	9.14 (0.360)
232	.82	M	4	N	9.14 (0.360)
439	.82	K	4	J	9.14 (0.360)
440	.82	M	4	J	9.14 (0.360)
191	1.0	K	4	N	9.14 (0.360)
192	1.0	M	4	N	9.14 (0.360)
441	1.0	K	4	J	9.14 (0.360)
442	1.0	M	4	J	9.14 (0.360)
193	1.2	K	4	N	9.14 (0.360)
194	1.2	M	4	N	9.14 (0.360)
443	1.2	K	4	J	9.14 (0.360)
444	1.2	M	4	J	9.14 (0.360)
195	1.5	K	4	N	12.2 (0.480)
196	1.5	M	4	N	12.2 (0.480)
445	1.5	K	4	J	12.2 (0.480)
446	1.5	M	4	J	12.2 (0.480)
197	1.8	K	4	N	16.5 (0.650)
198	1.8	M	4	N	16.5 (0.650)
447	1.8	K	4	J	16.5 (0.650)
448	1.8	M	4	J	16.5 (0.650)
233	2.2	K	3	N	6.10 (0.240)
234	2.2	M	3	N	6.10 (0.240)
449	2.2	K	3	J	6.10 (0.240)
450	2.2	M	3	J	6.10 (0.240)
199	2.7	K	3	N	9.14 (0.360)
200	2.7	M	3	N	9.14 (0.360)
451	2.7	K	3	J	9.14 (0.360)
452	2.7	M	3	J	9.14 (0.360)

DSCC Dwg. 87106-	Cap. Value (μF)	Cap. Tol.	Case Code	Lead Style	Max. A Dimension mm (inches)
500V					
201	3.3	K	3	N	9.14 (0.360)
202	3.3	M	3	N	9.14 (0.360)
453	3.3	K	3	J	9.14 (0.360)
454	3.3	M	3	J	9.14 (0.360)
203	3.9	K	3	N	9.14 (0.360)
204	3.9	M	3	N	9.14 (0.360)
455	3.9	K	3	J	9.14 (0.360)
456	3.9	M	3	J	9.14 (0.360)
205	4.7	K	3	N	12.2 (0.480)
206	4.7	M	3	N	12.2 (0.480)
457	4.7	K	3	J	12.2 (0.480)
458	4.7	M	3	J	12.2 (0.480)
207	5.6	K	3	N	16.5 (0.650)
208	5.6	M	3	N	16.5 (0.650)
459	5.6	K	3	J	16.5 (0.650)
460	5.6	M	3	J	16.5 (0.650)
235	6.8	K	1	N	12.2 (0.480)
236	6.8	M	1	N	12.2 (0.480)
461	6.8	K	1	J	12.2 (0.480)
462	6.8	M	1	J	12.2 (0.480)
209	8.2	K	1	N	12.2 (0.480)
210	8.2	M	1	N	12.2 (0.480)
463	8.2	K	1	J	12.2 (0.480)
464	8.2	M	1	J	12.2 (0.480)
211	10	K	1	N	12.2 (0.480)
212	10	M	1	N	12.2 (0.480)
465	10	K	1	J	12.2 (0.480)
466	10	M	1	J	12.2 (0.480)
213	12	K	1	N	16.5 (0.650)
214	12	M	1	N	16.5 (0.650)
467	12	K	1	J	16.5 (0.650)
468	12	M	1	J	16.5 (0.650)
237	15	K	2	N	16.5 (0.650)
238	15	M	2	N	16.5 (0.650)
469	15	K	2	J	16.5 (0.650)
470	15	M	2	J	16.5 (0.650)
215	18	K	2	N	16.5 (0.650)
216	18	M	2	N	16.5 (0.650)
471	18	K	2	J	16.5 (0.650)
472	18	M	2	J	16.5 (0.650)
239	22	K	6	N	9.14 (0.360)
240	22	M	6	N	9.14 (0.360)
473	22	K	6	J	9.14 (0.360)
474	22	M	6	J	9.14 (0.360)
217	27	K	6	N	9.14 (0.360)
218	27	M	6	N	9.14 (0.360)
475	27	K	6	J	9.14 (0.360)
476	27	M	6	J	9.14 (0.360)
219	33	K	6	N	12.2 (0.480)
220	33	M	6	N	12.2 (0.480)
477	33	K	6	J	12.2 (0.480)
478	33	M	6	J	12.2 (0.480)
221	39	K	6	N	16.5 (0.650)
222	39	M	6	N	16.5 (0.650)
479	39	K	6	J	16.5 (0.650)
480	39	M	6	J	16.5 (0.650)

SMPS Stacked MLC Capacitors

SM Style SM Military Styles DSCC Dwg. #88011 (COG)



CG (COG) Electrical characteristics per MIL-C-20

DSCC Dwg. 88011-	Cap. Value (µF)	Cap. Tol.	Case Code	Lead Style	Max. A Dimension mm (inches)
50V					
001*	.056	J	5	N	3.05 (0.120)
002*	.056	K	5	N	3.05 (0.120)
003*	.068	J	5	N	6.10 (0.240)
004*	.068	K	5	N	6.10 (0.240)
005*	.082	J	5	N	6.10 (0.240)
006*	.082	K	5	N	6.10 (0.240)
007*	.10	J	5	N	6.10 (0.240)
008*	.10	K	5	N	6.10 (0.240)
009*	.12	J	5	N	9.14 (0.360)
010*	.12	K	5	N	9.14 (0.360)
011*	.15	J	5	N	9.14 (0.360)
012*	.15	K	5	N	9.14 (0.360)
013*	.18	J	5	N	12.2 (0.480)
014*	.18	K	5	N	12.2 (0.480)
015*	.22	J	5	N	12.2 (0.480)
016*	.22	K	5	N	12.2 (0.480)
017*	.27	J	5	N	16.5 (0.650)
018*	.27	K	5	N	16.5 (0.650)
019*	.33	J	4	N	9.14 (0.360)
020*	.33	K	4	N	9.14 (0.360)
021*	.39	J	4	N	12.2 (0.480)
022*	.39	K	4	N	12.2 (0.480)
023*	.47	J	4	N	12.2 (0.480)
024*	.47	K	4	N	12.2 (0.480)
025*	.56	J	4	N	16.5 (0.650)
026*	.56	K	4	N	16.5 (0.650)
027*	.68	J	3	N	6.10 (0.240)
028*	.68	K	3	N	6.10 (0.240)
029*	.82	J	3	N	6.10 (0.240)
030*	.82	K	3	N	6.10 (0.240)
031*	1.0	J	3	N	9.14 (0.360)
032*	1.0	K	3	N	9.14 (0.360)
033*	1.2	J	3	N	9.14 (0.360)
034*	1.2	K	3	N	9.14 (0.360)
035*	1.5	J	3	N	12.2 (0.480)
036*	1.5	K	3	N	12.2 (0.480)
037*	1.8	J	3	N	12.2 (0.480)
038*	1.8	K	3	N	12.2 (0.480)
039*	2.2	J	3	N	16.5 (0.650)
040*	2.2	K	3	N	16.5 (0.650)
041*	2.7	J	1	N	9.14 (0.360)
042*	2.7	K	1	N	9.14 (0.360)
043*	3.3	J	1	N	12.2 (0.480)
044*	3.3	K	1	N	12.2 (0.480)
045*	3.9	J	1	N	12.2 (0.480)
046*	3.9	K	1	N	12.2 (0.480)
047*	4.7	J	1	N	16.5 (0.650)
048*	4.7	K	1	N	16.5 (0.650)
049*	5.6	J	2	N	16.5 (0.650)
050*	5.6	K	2	N	16.5 (0.650)
051*	6.8	J	6	N	9.14 (0.360)
052*	6.8	K	6	N	9.14 (0.360)
053*	8.2	J	6	N	9.14 (0.360)
054*	8.2	K	6	N	9.14 (0.360)
055*	10	J	6	N	12.2 (0.480)
056*	10	K	6	N	12.2 (0.480)
057*	12	J	6	N	12.2 (0.480)
058*	12	K	6	N	12.2 (0.480)
059*	15	J	6	N	16.5 (0.650)
060*	15	K	6	N	16.5 (0.650)
100V					
061*	.047	J	5	N	6.10 (0.240)
062*	.047	K	5	N	6.10 (0.240)
063*	.056	J	5	N	6.10 (0.240)
064*	.056	K	5	N	6.10 (0.240)
065*	.068	J	5	N	6.10 (0.240)
066*	.068	K	5	N	6.10 (0.240)
067*	.082	J	5	N	6.10 (0.240)
068*	.082	K	5	N	6.10 (0.240)
069*	.10	J	5	N	9.14 (0.360)
070*	.10	K	5	N	9.14 (0.360)
071*	.12	J	5	N	9.14 (0.360)
072*	.12	K	5	N	9.14 (0.360)
073*	.15	J	5	N	12.2 (0.480)
074*	.15	K	5	N	12.2 (0.480)
075*	.18	J	5	N	12.2 (0.480)
076*	.18	K	5	N	12.2 (0.480)
077*	.22	J	5	N	16.5 (0.650)
078*	.22	K	5	N	16.5 (0.650)
079*	.27	J	4	N	9.14 (0.360)

DSCC Dwg. 88011-	Cap. Value (µF)	Cap. Tol.	Case Code	Lead Style	Max. A Dimension mm (inches)
100V (continued)					
080*	.27	K	4	N	9.14 (0.360)
081*	.33	J	4	N	12.2 (0.480)
082*	.33	K	4	N	12.2 (0.480)
083*	.39	J	4	N	12.2 (0.480)
084*	.39	K	4	N	12.2 (0.480)
085*	.47	J	4	N	16.5 (0.650)
086*	.47	K	4	N	16.5 (0.650)
087*	.56	J	4	N	16.5 (0.650)
088*	.56	K	4	N	16.5 (0.650)
089*	.68	J	3	N	6.10 (0.240)
090*	.68	K	3	N	6.10 (0.240)
091*	.82	J	3	N	9.14 (0.360)
092*	.82	K	3	N	9.14 (0.360)
093*	1.0	J	3	N	9.14 (0.360)
094*	1.0	K	3	N	9.14 (0.360)
095*	1.2	J	3	N	12.2 (0.480)
096*	1.2	K	3	N	12.2 (0.480)
097*	1.5	J	3	N	12.2 (0.480)
098*	1.5	K	3	N	12.2 (0.480)
099*	1.8	J	3	N	16.5 (0.650)
100*	1.8	K	3	N	16.5 (0.650)
101*	2.2	J	1	N	12.2 (0.480)
102*	2.2	K	1	N	12.2 (0.480)
103*	2.7	J	1	N	12.2 (0.480)
104*	2.7	K	1	N	12.2 (0.480)
105*	3.3	J	1	N	16.5 (0.650)
106*	3.3	K	1	N	16.5 (0.650)
107*	3.9	J	2	N	12.2 (0.480)
108*	3.9	K	2	N	12.2 (0.480)
109*	4.7	J	2	N	16.5 (0.650)
110*	4.7	K	2	N	16.5 (0.650)
111*	5.6	J	6	N	9.14 (0.360)
112*	5.6	K	6	N	9.14 (0.360)
113*	6.8	J	6	N	9.14 (0.360)
114*	6.8	K	6	N	9.14 (0.360)
115*	8.2	J	6	N	12.2 (0.480)
116*	8.2	K	6	N	12.2 (0.480)
117*	10	J	6	N	16.5 (0.650)
118*	10	K	6	N	16.5 (0.650)
119*	12	J	6	N	16.5 (0.650)
120*	12	K	6	N	16.5 (0.650)
200V					
121*	.022	J	5	N	3.05 (0.120)
122*	.022	K	5	N	3.05 (0.120)
123*	.027	J	5	N	6.10 (0.240)
124*	.027	K	5	N	6.10 (0.240)
125*	.033	J	5	N	6.10 (0.240)
126*	.033	K	5	N	6.10 (0.240)
127*	.039	J	5	N	6.10 (0.240)
128*	.039	K	5	N	6.10 (0.240)
129*	.047	J	5	N	9.14 (0.360)
130*	.047	K	5	N	9.14 (0.360)
131*	.056	J	5	N	9.14 (0.360)
132*	.056	K	5	N	9.14 (0.360)
133*	.068	J	5	N	12.2 (0.480)
134*	.068	K	5	N	12.2 (0.480)
135*	.082	J	5	N	12.2 (0.480)
136*	.082	K	5	N	12.2 (0.480)
137*	.10	J	5	N	16.5 (0.650)
138*	.10	K	5	N	16.5 (0.650)
139*	.12	J	4	N	9.14 (0.360)
140*	.12	K	4	N	9.14 (0.360)
141*	.15	J	4	N	9.14 (0.360)
142*	.15	K	4	N	9.14 (0.360)
143*	.18	J	4	N	12.2 (0.480)
144*	.18	K	4	N	12.2 (0.480)
145*	.22	J	4	N	12.2 (0.480)
146*	.22	K	4	N	12.2 (0.480)
147*	.27	J	4	N	16.5 (0.650)
148*	.27	K	4	N	16.5 (0.650)
149*	.33	J	3	N	6.10 (0.240)
150*	.33	K	3	N	6.10 (0.240)
151*	.39	J	3	N	6.10 (0.240)
152*	.39	K	3	N	6.10 (0.240)
153*	.47	J	3	N	9.14 (0.360)
154*	.47	K	3	N	9.14 (0.360)
155*	.56	J	3	N	9.14 (0.360)
156*	.56	K	3	N	9.14 (0.360)
157*	.68	J	3	N	12.2 (0.480)
158*	.68	K	3	N	12.2 (0.480)

DSCC Dwg. 88011-	Cap. Value (µF)	Cap. Tol.	Case Code	Lead Style	Max. A Dimension mm (inches)
200V (continued)					
159*	.82	J	3	N	16.5 (0.650)
160*	.82	K	3	N	16.5 (0.650)
161*	1.0	J	3	N	16.5 (0.650)
162*	1.0	K	3	N	16.5 (0.650)
163*	1.2	J	1	N	12.2 (0.480)
164*	1.2	K	1	N	12.2 (0.480)
165*	1.5	J	1	N	12.2 (0.480)
166*	1.5	K	1	N	12.2 (0.480)
167*	1.8	J	1	N	16.5 (0.650)
168*	1.8	K	1	N	16.5 (0.650)
169*	2.2	J	2	N	12.2 (0.480)
170*	2.2	K	2	N	12.2 (0.480)
171*	2.7	J	2	N	16.5 (0.650)
172*	2.7	K	2	N	16.5 (0.650)
173*	3.3	J	6	N	9.14 (0.360)
174*	3.3	K	6	N	9.14 (0.360)
175*	3.9	J	6	N	9.14 (0.360)
176*	3.9	K	6	N	9.14 (0.360)
177*	4.7	J	6	N	12.2 (0.480)
178*	4.7	K	6	N	12.2 (0.480)
179*	5.6	J	6	N	16.5 (0.650)
180*	5.6	K	6	N	16.5 (0.650)
500V					
181*	.010	J	5	N	3.05 (0.120)
182*	.010	K	5	N	3.05 (0.120)
183*	.012	J	5	N	6.10 (0.240)
184*	.012	K	5	N	6.10 (0.240)
185*	.015	J	5	N	6.10 (0.240)
186*	.015	K	5	N	6.10 (0.240)
187*	.018	J	5	N	6.10 (0.240)
188*	.018	K	5	N	6.10 (0.240)
189*	.022	J	5	N	9.14 (0.360)
190*	.022	K	5	N	9.14 (0.360)
191*	.027	J	5	N	9.14 (0.360)
192*	.027	K	5	N	9.14 (0.360)
193*	.033	J	5	N	12.2 (0.480)
194*	.033	K	5	N	12.2 (0.480)
195*	.039	J	5	N	12.2 (0.480)
196*	.039	K	5	N	12.2 (0.480)
197*	.047	J	5	N	16.5 (0.650)
198*	.047	K	5	N	16.5 (0.650)
199*	.056	J	4	N	9.14 (0.360)
200*	.056	K	4	N	9.14 (0.360)
201*	.068	J	4	N	9.14 (0.360)
202*	.068	K	4	N	9.14 (0.360)
203*	.082	J	4	N	12.2 (0.480)
204*	.082	K	4	N	12.2 (0.480)
205*	.10	J	4	N	12.2 (0.480)
206*	.10	K	4	N	12.2 (0.480)
207*	.12	J	4	N	16.5 (0.650)
208*	.12	K	4	N	16.5 (0.650)
209*	.15	J	3	N	6.10 (0.240)
210*	.15	K	3	N	6.10 (0.240)
211*	.18	J	3	N	6.10 (0.240)
212*	.18	K	3	N	6.10 (0.240)
213*	.22	J	3	N	9.14 (0.360)
214*	.22	K	3	N	9.14 (0.360)
215*	.27	J	3	N	9.14 (0.360)
216*	.27	K	3	N	9.14 (0.360)
217*	.33	J	3	N	12.2 (0.480)
218*	.33	K	3	N	12.2 (0.480)
219*	.39	J	3	N	16.5 (0.650)
220*	.39	K	3	N	16.5 (0.650)
221*	.47	J	1	N	9.14 (0.360)
222*	.47	K	1	N	9.14 (0.360)
223*	.56	J	1	N	12.2 (0.480)
224*	.56	K	1	N	12.2 (0.480)
225*	.68	J	1	N	12.2 (0.480)
226*	.68	K			

SMPS Stacked MLC Capacitors

SM9 Style Technical Information on SMPS Capacitors

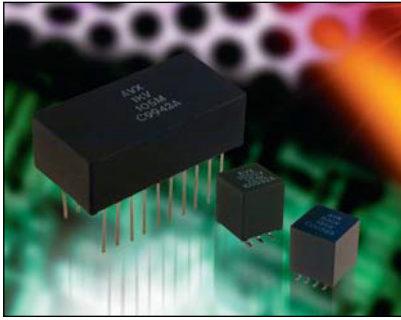

AVX is the original inventor of large capacitance value, stacked MLCC capacitors constructed with DIP leads. Similar to SM-product, the SM9-style, encapsulated Switch Mode Power Supply (SMPS) capacitors offer high CV product and extremely low ESR and ESL. SM9-style capacitors offer additional mechanical and thermal protection and are recommended for applications where they will undergo extreme high frequency vibration or mechanical shock. Encapsulated version allows for “strapping” the parts or bonding to the board on the perimeter of the plastic case and thus preventing oscillation and lead breakage.

In addition to traditionally offered COG (Class I) and X7R (Class II) type dielectrics, AVX introduces another class I, temperature compensated N1500 dielectric characterized with very low dissipation factor. Thanks to considerably higher relative dielectric constant of N1500 dielectric, the CV product is more than doubled in comparison to ultra-stable COG dielectric, resulting in a significant reduction in the size of capacitor and a significant improvement of volumetric efficiency.

The typical applications for different type dielectrics are:

- COG: High frequency resonant capacitors, avionic AC line filters (400Hz to 800Hz), snubbers, timing circuits, high current repetitive discharge
- N1500: Avionic AC line filters (400Hz to 800Hz), snubbers, high current repetitive discharge, capacitive temperature compensation
- X7R: General filtering, input and output filters in DC/DC converters, bulk filters, DC link capacitors, motor drive filters, high current non-repetitive discharge

Not RoHS Compliant

GENERAL SPECIFICATIONS FOR ALL DIELECTRIC TYPES

Operating Temperature Range

-55° to +125°C

Voltage Ratings

50VDC through 500VDC (+125°C)

Dielectric Withstanding Voltage

250% rated voltage for 5 seconds with 30 to 50mA charging current (500 Volt units @ 750VDC)

Insulation Resistance (25°C, rated DC voltage)

100KMΩ min. or 1000MΩ-μF min. whichever is less

Insulation Resistance (125°C, rated DC voltage)

10KMΩ min. or 100MΩ-μF min. whichever is less

Thermal Shock Capabilities

5 cycles (-55°C to +125°C)

Life Test Capabilities (1000 hours)

200% rated voltage at +125°C (500 Volt units @ 600VDC)

GENERAL SPECIFICATIONS FOR ALL DIELECTRIC TYPES

COG Dielectric

Capacitance Range

0.01μF to 15μF
(+25°C, 1.0 ± 0.2Vrms at 1kHz)

Capacitance Tolerances

±5%, ±10%, ±20%

Temperature Characteristic

0 ± 30 ppm/°C

Dissipation Factor

0.15% max.
(+25°C, 1.0 ± 0.2Vrms at 1kHz)

N1500

Capacitance Range

0.018μF to 33μF
(+25°C, 1.0 ± 0.2Vrms at 1kHz)

Capacitance Tolerances

±5%, ±10%, ±20%

Temperature Characteristic

-1500 ± 250 ppm/°C

Dissipation Factor

0.15% max.
(+25°C, 1.0 ± 0.2Vrms at 1kHz)

X7R Dielectric

Capacitance Range

0.1μF to 390μF
(+25°C, 1.0 ± 0.2Vrms at 1kHz)

Capacitance Tolerances

±10%, ±20%, +80%, -20%

Temperature Characteristic

±15%

Dissipation Factor

2.5% max.
(+25°C, 1.0 ± 0.2Vrms at 1kHz)

SMPS Stacked MLC Capacitors

SM9 Style Technical Information on SMPS Capacitors



HOW TO ORDER

AVX Styles: SM91, SM92, SM93, SM94, SM95, SM96

SM9	1	7	C	106	M	A	N	660
AVX Style SM9 = Plastic Case	Size See Dimensions chart	Voltage 50V = 5 100V = 1 200V = 2 500V = 7	Temperature Coefficient C0G = A N1500 = 4 X7R = C	Capacitance Code (2 significant digits + number of zeros) 1,000 pF = 102 22,000 pF = 223 220,000 pF = 224 1 μF = 105 10 μF = 106 100 μF = 107	Capacitance Tolerance C0G/N1500: J = ±5% K = ±10% M = ±20% X7R: K = ±10% M = ±20% Z = +80%, -20%	Test Level A = Standard B = Hi-Rel* 5 = Standard/MIL** 6 = Hi-Rel/MIL***	Termination N = Straight Lead J = Leads formed in L = Leads formed out	Height Max Dimension "A" 270 = 0.270" 390 = 0.390" 530 = 0.530" 660 = 0.660" 800 = 0.800"

See tables for capacitance available in specific height and dielectric

Note: Capacitors with X7R dielectric are not intended for applications across AC supply mains or AC line filtering with polarity reversal. Contact plant for recommendations.

* Hi-Rel screening option. Screening consists of 100% Group A (B Level), Subgroup 1 per MIL-PRF-49470.

** Form, fit & function equivalent to MIL-PRF-49470 part.

Applies to 50V rated parts only. No screening.

*** Form, fit & function equivalent to MIL-PRF-49470 part.

Applies to 50V rated parts only. Hi-Rel screening the same as option B.

Typical ESR Performance (mΩ)					
	Aluminum Electrolytic 100μF/50V	Low ESR Solid Tantalum 100μF/10V	Solid Aluminum Electrolytic 100μF/16V	MLCC SMPS 100μF/50V	MLCC SMPS 4.7μF/50V
ESR @ 10KHz	300	72	29	3	66
ESR @ 50KHz	285	67	22	2	23
ESR @ 100KHz	280	62	20	2.5	15
ESR @ 500KHz	265	56	18	4	8
ESR @ 1MHz	265	56	17	7	7.5
ESR @ 5MHz	335	72	17	12.5	8
ESR @ 10MHz	560	91	22	20	14

Performance of SMPS capacitors can be simulated by downloading SpiCalci software program - <http://www.avx.com/download/software/SpiCalci-AVX.zip>

SMPS Stacked MLC Capacitors

Encapsulated in DAP (Diallyl Phthalate) Case (SM9 Style)

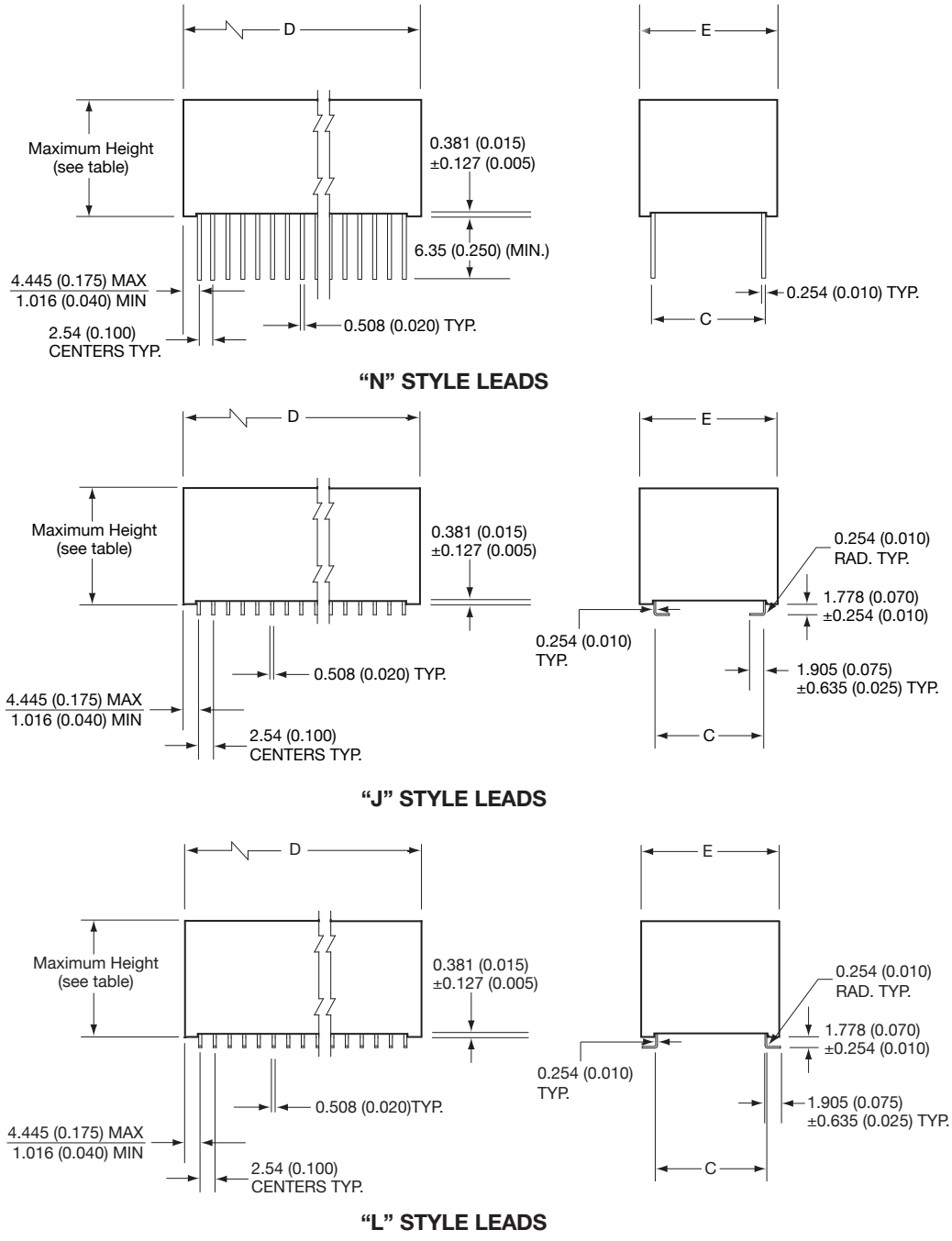

DIMENSIONS

millimeters (inches)

Case Code	C ±0.635 (0.025)	D ±0.254 (0.010)	E +0.000 (0.000) -0.254 (0.010)	No. of Leads per side*
SM91	11.4 (0.450)	54.7 (2.155)	14.7 (0.580)	20
SM92	20.3 (0.800)	41.0 (1.615)	24.1 (0.950)	15
SM93	11.4 (0.450)	29.3 (1.155)	14.7 (0.580)	10
SM94	10.2 (0.400)	12.3 (0.485)	12.3 (0.485)	4
SM95	6.35 (0.250)	9.02 (0.355)	9.02 (0.355)	3
SM96	31.8 (1.250)	54.7 (2.155)	36.3 (1.430)	20

*Leads styles N, J or L available

RoHS Compliant SMPS Stacked MLC Capacitors



RM Style Stacked MLC Capacitors

ELECTRICAL SPECIFICATIONS

Temperature Coefficient

COG: A Temperature Coefficient - 0 ± 30 ppm/°C, -55° to +125°C
 X7R: C Temperature Coefficient - $\pm 15\%$, -55° to +125°C

Capacitance Test (MIL-STD-202 Method 305)

COG: 25°C, 1.0 ± 0.2 Vrms (open circuit voltage) at 1KHz
 X7R: 25°C, 1.0 ± 0.2 Vrms (open circuit voltage) at 1KHz

Dissipation Factor 25°C

COG: 0.15% Max @ 25°C, 1.0 ± 0.2 Vrms (open circuit voltage) at 1KHz
 X7R: 2.5% Max @ 25°C, 1.0 ± 0.2 Vrms (open circuit voltage) at 1KHz

Insulation Resistance 25°C (MIL-STD-202 Method 302)

COG and X7R: 100K MΩ or 1000 MΩ-μF, whichever is less.

Insulation Resistance 125°C (MIL-STD-202 Method 302)

COG and X7R: 10K MΩ or 100 MΩ-μF, whichever is less.

Dielectric Withstanding Voltage 25°C (Flash Test)

COG and X7R: 250% rated voltage for 5 seconds with 50 mA max charging current. (500 Volt units @ 750 VDC)

Life Test (1000 hrs)

COG and X7R: 200% rated voltage at +125°C. (500 Volt units @ 600 VDC)

Moisture Resistance (MIL-STD-202 Method 106)

COG, X7R: Ten cycles with no voltage applied.

Thermal Shock (MIL-STD-202 Method 107, Condition A)

Immersion Cycling (MIL-STD-202 Method 104, Condition B)

Resistance To Solder Heat (MIL-STD-202, Method 210, Condition B, for 20 seconds)

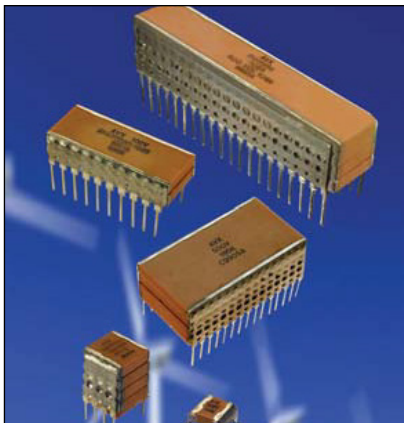

Typical ESR Performance (mΩ)					
	Aluminum Electrolytic 100μF/50V	Low ESR Solid Tantalum 100μF/10V	Solid Aluminum Electrolytic 100μF/16V	MLCC SMPS 100μF/50V	MLCC SMPS 4.7μF/50V
ESR @ 10KHz	300	72	29	3	66
ESR @ 50KHz	285	67	22	2	23
ESR @ 100KHz	280	62	20	2.5	15
ESR @ 500KHz	265	56	18	4	8
ESR @ 1MHz	265	56	17	7	7.5
ESR @ 5MHz	335	72	17	12.5	8
ESR @ 10MHz	560	91	22	20	14

HOW TO ORDER

AVX Styles: RM-1, RM-2, RM-3, RM-4, RM-5, RM-6

RM0	1	7	C	106	M	A	N	650
AVX Style RM0 = Uncoated RM5 = Epoxy Coated	Size See Dimensions chart	Voltage 50V = 5 100V = 1 200V = 2 500V = 7	Temperature Coefficient COG = A X7R = C	Capacitance Code (2 significant digits + number of zeros) 10 pF = 100 100 pF = 101 1,000 pF = 102 22,000 pF = 223 220,000 pF = 224 1 μF = 105 10 μF = 106 100 μF = 107	Capacitance Tolerance COG: J = $\pm 5\%$ K = $\pm 10\%$ M = $\pm 20\%$ X7R: K = $\pm 10\%$ M = $\pm 20\%$ Z = $+80\%$, -20%	Test Level A = Standard	Termination N = Straight Lead J = Leads formed in L = Leads formed out P = P Style Leads Z = Z Style Leads	Height Max Dimension "A" 120 = 0.120" 240 = 0.240" 360 = 0.360" 480 = 0.480" 650 = 0.650"



Note: Capacitors with X7R and Z5U dielectrics are not intended for applications across AC supply mains or AC line filtering with polarity reversal. Contact plant for recommendations.

Performance of SMPS capacitors can be simulated by downloading SpiCalci software program -
<http://www.avx.com/download/software/SpiCalci-AVX.zip>
 Custom values, ratings and configurations are also available.



The Important Information/Disclaimer is incorporated in the catalog where these specifications came from or available online at www.avx.com/disclaimer/ by reference and should be reviewed in full before placing any order.

RoHS Compliant SMPS Stacked MLC Capacitors (RM Style) Surface Mount and Thru-Hole Styles (RM0, RM5)

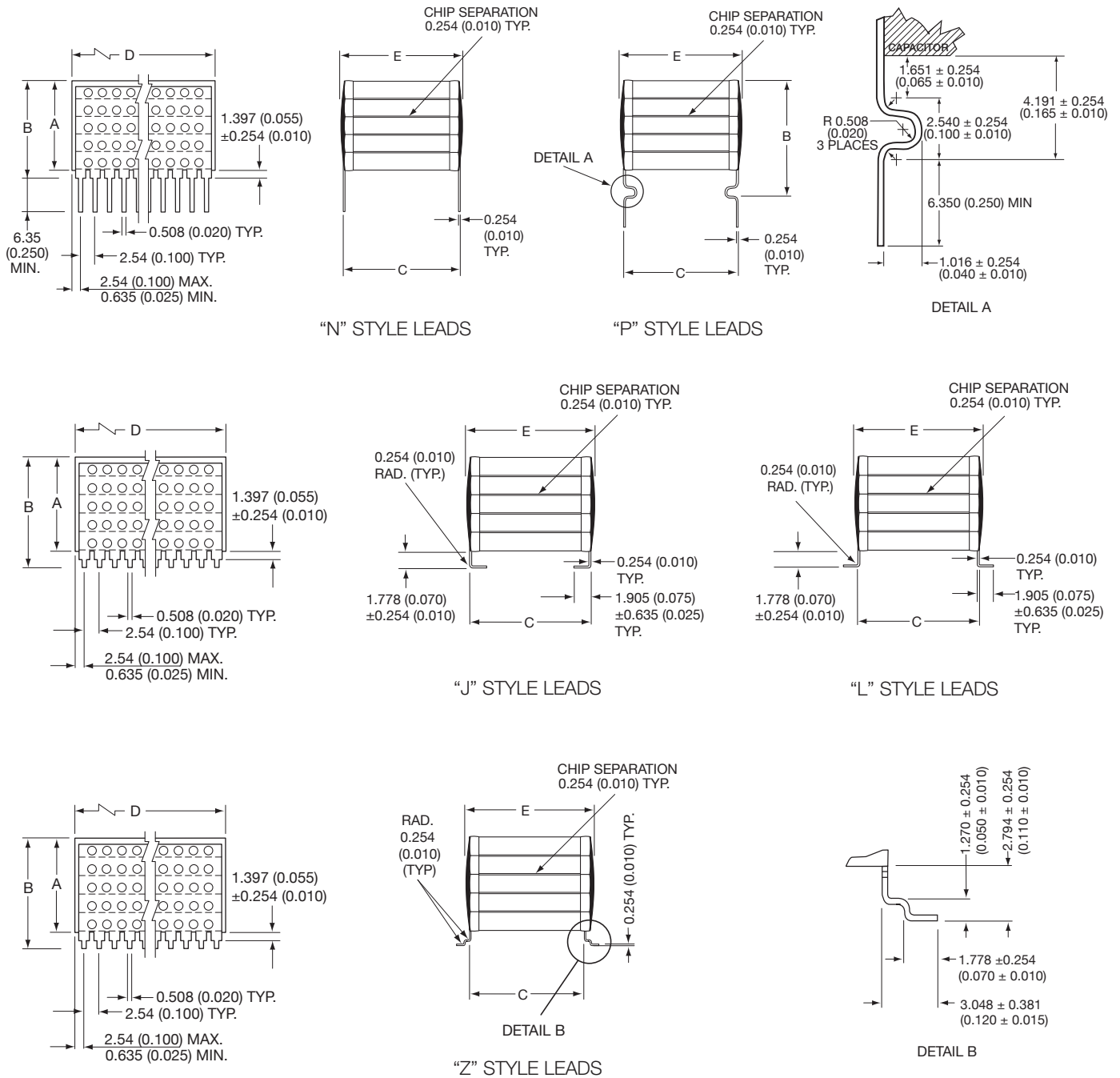

DIMENSIONS

millimeters (inches)

Style	A (max.)	B (max.)	C ±.635 (±0.025)	D ±.635 (±0.025)	E (max.)	No. of Leads per side
RM-1	See page 38 for maximum "A" Dimension	For "N" Style Leads: "A" Dimension Plus 1.651 (0.065) For "J" & "L" Style Leads: "A" Dimension Plus 2.032 (0.080) For "P" Style Leads: "A" Dimension Plus 4.445 (0.175) For "Z" Style Leads: "A" Dimension Plus 3.048 (0.120)	11.4 (0.450)	52.1 (2.050)	12.7 (0.500)	20
RM-2			20.3 (0.800)	38.4 (1.510)	22.1 (0.870)	15
RM-3			11.4 (0.450)	26.7 (1.050)	12.7 (0.500)	10
RM-4			10.2 (0.400)	10.2 (0.400)	11.2 (0.440)	4
RM-5			6.35 (0.250)	6.35 (0.250)	7.62 (0.300)	3
RM-6			31.8 (1.250)	52.1 (2.050)	34.3 (1.350)	20

Note: For RM5 add 0.127 (0.005) to max. and nominal dimensions A, B, D, & E

RoHS Compliant SMPS Stacked MLC Capacitors

(RM Style)



Max Capacitance (µF) Available Versus Style with Height (A) of 0.120" - 3.05mm

AVX STYLE	RM01 _____ AN120				RM02 _____ AN120				RM03 _____ AN120				RM04 _____ AN120				RM05 _____ AN120				RM06 _____ AN120							
	50V	100V	200V	500V	50V	100V	200V	500V	50V	100V	200V	500V	50V	100V	200V	500V	50V	100V	200V	500V	50V	100V	200V	500V	50V	100V	200V	500V
COG	1.0	.70	.40	.18	1.2	1.0	.60	.26	.47	.40	.20	.09	.16	.13	.07	.02	.05	.04	.02	.01	3.2	2.4	1.3	.50				
X7R	27	12	7.0	2.6	41	18	11	4.0	18	6.0	3.6	1.3	7.5	1.8	1.1	.40	2.8	.68	.40	.16	80	40	24	9.4				

Max Capacitance (µF) Available Versus Style with Height (A) of 0.240" - 6.10mm

AVX STYLE	RM01 _____ AN240				RM02 _____ AN240				RM03 _____ AN240				RM04 _____ AN240				RM05 _____ AN240				RM06 _____ AN240							
	50V	100V	200V	500V	50V	100V	200V	500V	50V	100V	200V	500V	50V	100V	200V	500V	50V	100V	200V	500V	50V	100V	200V	500V	50V	100V	200V	500V
COG	2.0	1.4	.80	.36	2.4	2.0	1.2	.52	1.0	.80	.40	.18	.32	.26	.14	.05	.10	.08	.05	.02	6.4	4.8	2.6	1.0				
X7R	54	24	14	5.2	82	36	22	8.0	36	12	7.2	2.6	15	3.6	2.2	.80	5.6	1.3	.80	.32	160	80	48	18				

Max Capacitance (µF) Available Versus Style with Height (A) of 0.360" - 9.14mm

AVX STYLE	RM01 _____ AN360				RM02 _____ AN360				RM03 _____ AN360				RM04 _____ AN360				RM05 _____ AN360				RM06 _____ AN360							
	50V	100V	200V	500V	50V	100V	200V	500V	50V	100V	200V	500V	50V	100V	200V	500V	50V	100V	200V	500V	50V	100V	200V	500V	50V	100V	200V	500V
COG	3.0	2.1	1.2	.54	3.6	3.0	1.8	.78	1.5	1.2	.60	.27	.48	.39	.21	.07	.15	.12	.07	.03	9.6	7.2	3.9	1.5				
X7R	82	36	21	7.8	120	54	33	12	54	18	10	3.9	22	5.4	3.3	1.2	8.2	2.0	1.2	.48	240	120	72	28				

Max Capacitance (µF) Available Versus Style with Height (A) of 0.480" - 12.2mm

AVX STYLE	RM01 _____ AN480				RM02 _____ AN480				RM03 _____ AN480				RM04 _____ AN480				RM05 _____ AN480				RM06 _____ AN480							
	50V	100V	200V	500V	50V	100V	200V	500V	50V	100V	200V	500V	50V	100V	200V	500V	50V	100V	200V	500V	50V	100V	200V	500V	50V	100V	200V	500V
COG	4.0	2.8	1.6	.72	4.8	4.0	2.2	1.0	2.0	1.6	.80	.36	.64	.52	.28	.10	.20	.16	.10	.04	12	9.6	5.2	2.0				
X7R	110	48	28	10	160	72	44	16	72	24	14	5.2	30	7.2	4.4	1.6	10	2.7	1.6	.64	320	160	96	37				

Max Capacitance (µF) Available Versus Style with Height (A) of 0.650" - 16.5mm

AVX STYLE	RM01 _____ AN650				RM02 _____ AN650				RM03 _____ AN650				RM04 _____ AN650				RM05 _____ AN650				RM06 _____ AN650							
	50V	100V	200V	500V	50V	100V	200V	500V	50V	100V	200V	500V	50V	100V	200V	500V	50V	100V	200V	500V	50V	100V	200V	500V	50V	100V	200V	500V
COG	5.0	3.5	2.0	.90	6.0	5.0	3.0	1.3	2.5	2.0	1.0	.47	.80	.65	.35	.12	.25	.20	.12	.05	16	12	6.5	2.5				
X7R	130	60	35	13	200	90	55	20	90	30	18	6.5	36	9.0	5.5	2.0	12	3.4	2.0	.80	400	200	120	47				

SMPS Stacked MLC Capacitors

SMM Style Stacked MLC Capacitors Extended Range

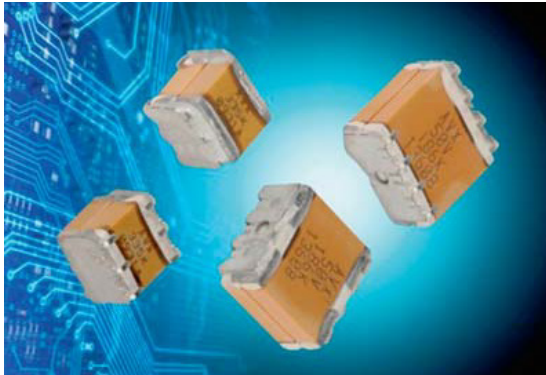

GENERAL DESCRIPTION

The SMM series SMPS capacitors incorporate the Super X7R dielectric material. AVX SMM stacked capacitors offer high dielectric constant (K) characteristics allowing for an extended capacitance range. The higher capacitance values in the smaller case sizes reduce the amount of board space needed to mount these components. The SMM series capacitors are designed for use in applications ranging from high end DC/DC converters to general power supplies, telecom networks, snubbers, aerospace instrumentation panels, hybrid power applications and more.

ELECTRICAL SPECIFICATIONS

Temperature Coefficient

±15%, -55°C to +125°C

Capacitance Test (MIL-STD-202 Method 305)

25°C, 1.0 ± 0.2 Vrms (open circuit voltage) at 1 kHz

Dissipation Factor 25°C

2.5% Max @ 25°C, 1.0 ± 0.2 Vrms (open circuit voltage) at 1 kHz

Insulation Resistance 25°C (MIL-STD-202 Method 302)

1000 MΩ-μF, whichever is less

Insulation Resistance 125°C (MIL-STD-202 Method 302)

100 MΩ-μF, whichever is less

Dielectric Withstanding Voltage 25°C (Flash Test)

250% rated voltage for 5 seconds with 50 mA maximum charging current (500 Volt units @ 750 VDC)

Life Test (1000 hrs)

200% rated voltage for at 125°C (500 Volts units @ 600 VDC)

Not RoHS Compliant

HOW TO ORDER

SMM4	5	C	186	M	A	K	120
AVX Style	Voltage	Temperature Coefficient	Capacitance Code	Tolerance	Test Level	Leads	Height
SMM3	50V = 5	X7R = C	(pF - 2 significant digits + number of zeros)	K = ±10%	A = Standard	N = Straight Lead	Max
SMM4	100V = 1		1μF = 105	M = ±20%	B = Hi-Rel*	K = Leads formed in	Dimension "A"
SMM5	200V = 2		10 μF = 106			M = Leads formed out	120 = 0.120"
	500V = 7		100 μF = 107				240 = 0.240"
							360 = 0.360"
							480 = 0.480"
							600 = 0.600"

*Hi-Rel screening for consists of 100% Group A (B Level), Subgroup 1 per MIL-PRF-49470.

SMPS Stacked MLC Capacitors

SMM Style Stacked MLC Capacitors Extended Range

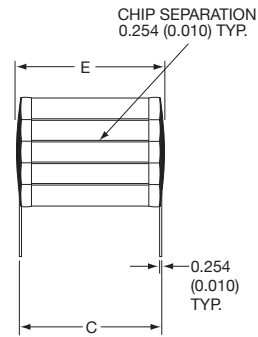
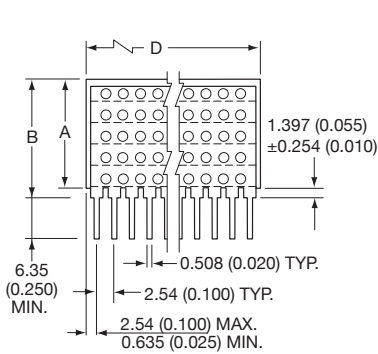

“N” STYLE LEADS

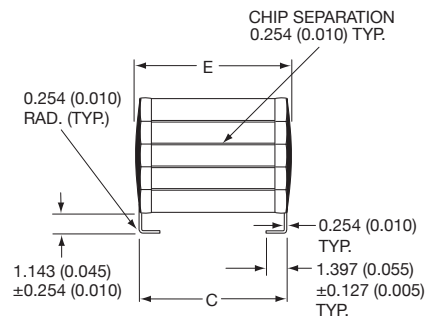
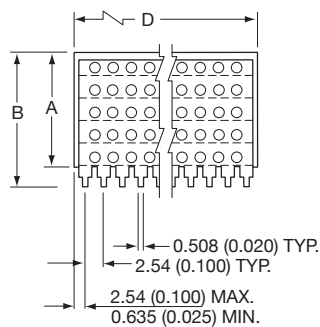

“K” STYLE LEADS

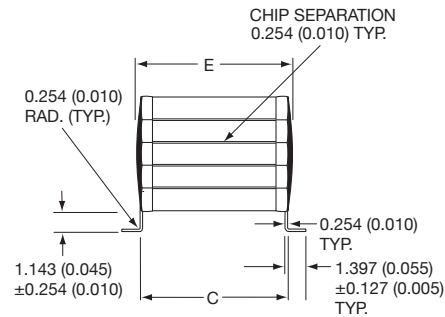
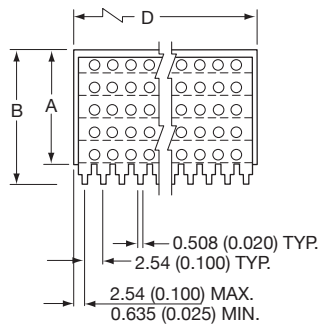

“M” STYLE LEADS

DIMENSIONS

millimeters (inches)

Style	A (max.)	B (max.)	C ±.635 (±0.025)	D ±.635 (±0.025)	E (max.)	No. of Leads per side
SMM3	See next table below for maximum "A" Dimension	For "N" Style Leads: "A" Dimension Plus 1.651 (0.065) For "K" & "M" Style Leads: "A" Dimension Plus 1.39 (0.055)	11.4 (0.450)	26.7 (1.050)	12.7 (0.500)	10
SMM4			10.2 (0.400)	10.2 (0.400)	11.2 (0.440)	4
SMM5			6.35 (0.250)	6.35 (0.250)	7.62 (0.300)	3

CAPACITANCE RANGE

Max Capacitance (µF) Available Versus Style and Height (Diminsion "A")

AVX STYLE	SMM3				SMM4				SMM5			
	50V	100V	200V	500V	50V	100V	200V	500V	50V	100V	200V	500V
0.120"	27	15	8.2	3.9	10	4.7	3.3	1.2	3.9	1.8	1.2	0.56
0.240"	56	27	15	6.8	18	8.2	6.8	2.2	6.8	3.3	2.2	1.0
0.360"	82	47	22	12	27	12	10	3.3	12	5.6	3.3	1.6
0.480"	100	56	33	15	39	18	12	4.7	15	6.8	4.7	2.2
0.600"	120	68	39	18	49	22	15	5.6	18	8.2	5.6	2.7

RoHS Compliant SMPS Stacked MLC Capacitors

RMM Style Stacked MLC Capacitors Extended Range

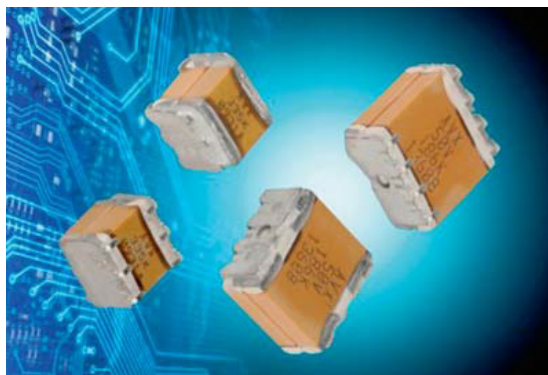

GENERAL DESCRIPTION

The RMM series SMPS capacitors incorporate the Super X7R dielectric material. AVX RMM stacked capacitors offer high dielectric constant (K) characteristics allowing for an extended capacitance range. The higher capacitance values in the smaller case sizes reduce the amount of board space needed to mount these components. The RMM series capacitors are designed for use in applications ranging from high end DC/DC converters to general power supplies, telecom networks, snubbers, aerospace instrumentation panels, hybrid power applications and more.

ELECTRICAL SPECIFICATIONS

Temperature Coefficient

±15%, -55°C to +125°C

Capacitance Test (MIL-STD-202 Method 305)

25°C, 1.0 ± 0.2 Vrms (open circuit voltage) at 1 kHz

Dissipation Factor 25°C

2.5% Max @ 25°C, 1.0 ± 0.2 Vrms (open circuit voltage) at 1 kHz

Insulation Resistance 25°C (MIL-STD-202 Method 302)

1000 MΩ-μF, whichever is less

Insulation Resistance 125°C (MIL-STD-202 Method 302)

100 MΩ-μF, whichever is less

Dielectric Withstanding Voltage 25°C (Flash Test)

250% rated voltage for 5 seconds with 50 mA maximum charging current (500 Volt units @ 750 VDC)

Life Test (1000 hrs)

200% rated voltage for at 125°C (500 Volts units @ 600 VDC)



HOW TO ORDER

RMM4

AVX Style
RMM3
RMM4
RMM5

5

Voltage
50V = 5
100V = 1
200V = 2
500V = 7

C

Temperature Coefficient
X7R = C

186

Capacitance Code
(pF - 2 significant digits + number of zeros)
1 μF = 105
10 μF = 106
100 μF = 107

M

Tolerance
K = ±10%
M = ±20%

A

Test Level
A = Standard
B = Hi-Rel*

K

Leads
N = Straight Lead
K = Leads formed in
M = Leads formed out

120

Height Max
Dimension "A"
120 = 0.120"
240 = 0.240"
360 = 0.360"
480 = 0.480"
600 = 0.600"

*Hi-Rel screening for consists of 100% Group A (B Level), Subgroup 1 per MIL-PRF-49470.

RoHS Compliant SMPS Stacked MLC Capacitors

RMM Style Stacked MLC Capacitors Extended Range

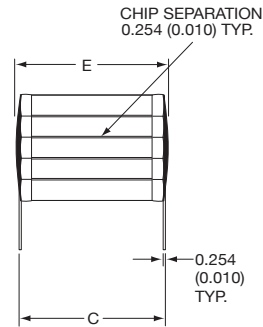
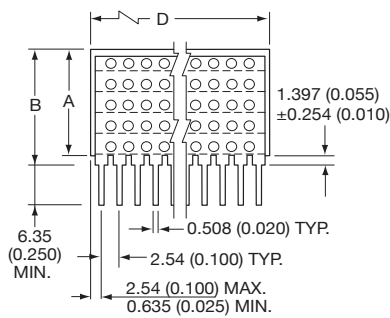

“N” STYLE LEADS

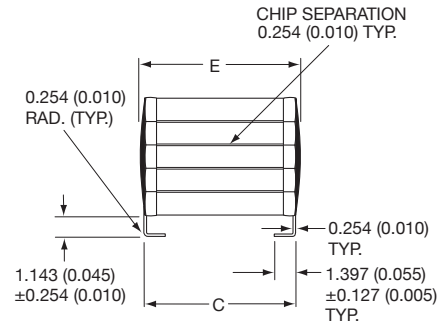
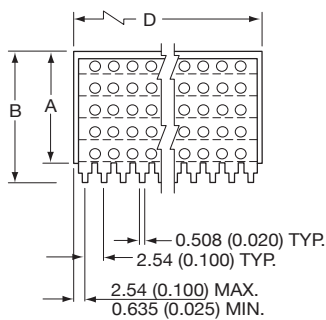

“K” STYLE LEADS

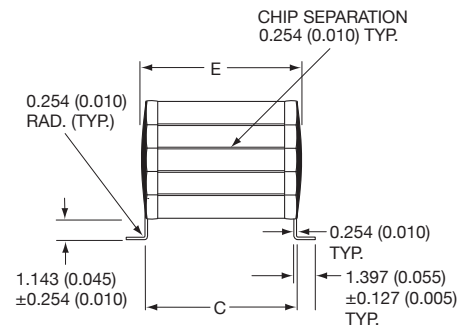
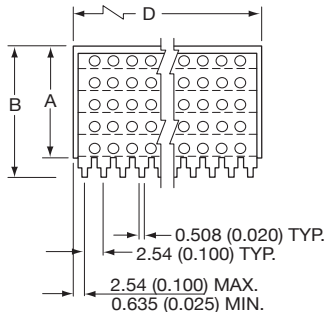

“M” STYLE LEADS

DIMENSIONS

millimeters (inches)

Style	A (max.)	B (max.)	C ±.635 (±0.025)	D ±.635 (±0.025)	E (max.)	No. of Leads per side
RMM3	See next table below for maximum "A" Dimension	For "N" Style Leads: "A" Dimension Plus 1.651 (0.065) For "K" & "M" Style Leads: "A" Dimension Plus 1.39 (0.055)	11.4 (0.450)	26.7 (1.050)	12.7 (0.500)	10
RMM4			10.2 (0.400)	10.2 (0.400)	11.2 (0.440)	4
RMM5			6.35 (0.250)	6.35 (0.250)	7.62 (0.300)	3

CAPACITANCE RANGE

Max Capacitance (µF) Available Versus Style and Height (Diminsion "A")

AVX STYLE	SMM3				SMM4				SMM5			
Height "A"	50V	100V	200V	500V	50V	100V	200V	500V	50V	100V	200V	500V
0.120"	27	15	8.2	3.9	10	4.7	3.3	1.2	3.9	1.8	1.2	0.56
0.240"	56	27	15	6.8	18	8.2	6.8	2.2	6.8	3.3	2.2	1.0
0.360"	82	47	22	12	27	12	10	3.3	12	5.6	3.3	1.6
0.480"	100	56	33	15	39	18	12	4.7	15	6.8	4.7	2.2
0.600"	120	68	39	18	49	22	15	5.6	18	8.2	5.6	2.7

SMPS Stacked MLC Capacitors

SMX Style for High Temperature Applications up to 200°C



SMX-style, stacked Switch Mode Power Supply Capacitors (SMPS) utilizing Multilayer Ceramic (MLCC) construction are ideally suited for high temperature applications up to 200°C. This product is intended for downhole oil exploration, including logging while drilling, geophysical probes, as well as space and aerospace electronics. The high temperature solder utilized in the construction of SMX-style parts assures reliable operation in harsh environments. The wide product offering provides designers a solution for high capacitance value and high voltage capacitors rated at 200°C. The SMX-style capacitors are ideally suited for applications as DC filters in high power, high frequency motor drives, high pulsed-current circuitry, as well as low power electronics.

SMX-style, SMPS capacitors are characterized with excellent performance in comparison to wet tantalum products. The main benefits of SMX-product over wet tantalum capacitors include:

- Much lower ESR and lower losses
- Excellent capacitance retention with frequency
- Excellent high frequency performance
- Low DC leakage current
- Much higher current handling capabilities

Typical Extended Temperature TCC
Characterization of C0G, SMPS Capacitors
 Test conditions: 1 Vrms, 1 kHz, 0 VDC bias

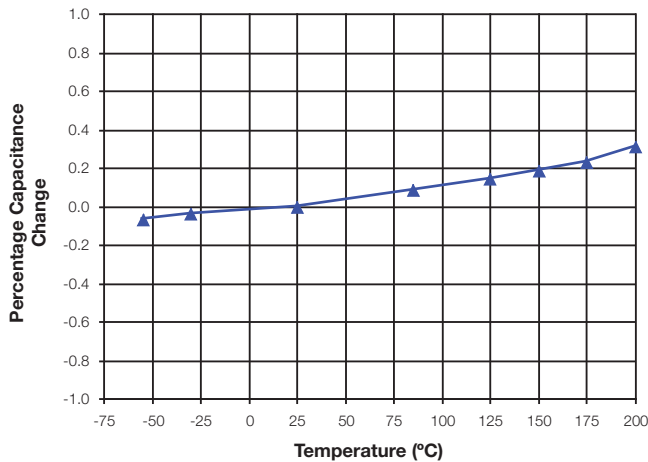

Typical Extended Temperature TCC
Characterization of VHT/X7R, SMPS Capacitors
 Test conditions: 1 Vrms, 1 kHz, 0 VDC bias

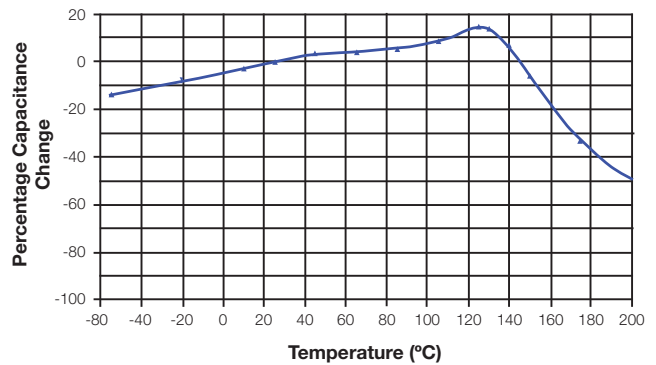

Typical Extended Temperature IR Characterization of C0G, SMPS Capacitors

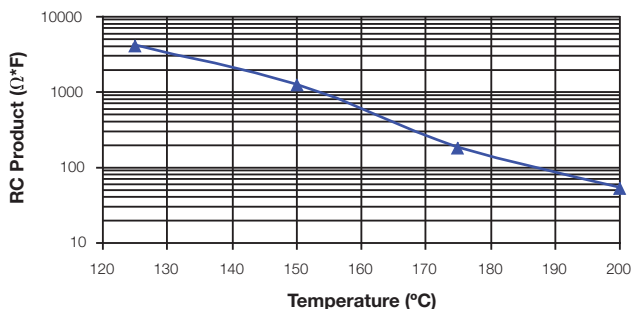

Typical Extended Temperature IR Characterization of VHT/X7R, SMPS Capacitors

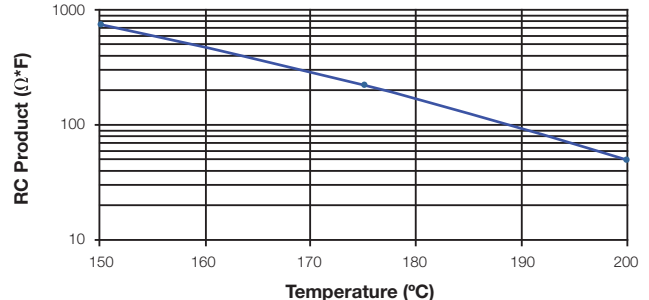

SMPS Stacked MLC Capacitors

SMX Style for High Temperature Applications up to 200°C



ELECTRICAL SPECIFICATIONS

Temperature Coefficient

C0G: A Temperature Coefficient 0 ±30 ppm/°C, -55° to +200°C
 VHT/X7R: C Temperature Coefficient ±15%, -55°C to +125°C
 +15% - 56%, -55°C to +200°C

Capacitance Test (MIL-STD-202 Method 305)

25°C, 1.0±0.2 Vrms (open circuit voltage) at 1KHz

Dissipation Factor 25°C

C0G: 0.15% Max @ 25°C, 1.0±0.2 Vrms (open circuit voltage) at 1KHz
 VHT/X7R: 2.5% Max @ 25°C, 1.0±0.2 Vrms (open circuit voltage) at 1KHz

Insulation Resistance 25°C (MIL-STD-202 Method 302)

100K MΩ or 1000 MΩ-μF, whichever is less.

Insulation Resistance 125°C (MIL-STD-202 Method 302)

10K MΩ or 100 MΩ-μF, whichever is less.

Insulation Resistance 200°C (MIL-STD-202 Method 302)

1K MΩ or 10 MΩ -μF, whichever is less.

Dielectric Withstanding Voltage 25°C (Flash Test)

250% rated voltage for 5 seconds with 50 mA max charging current. (500 Volt units @ 750 VDC)

Moisture Resistance (MIL-STD-202 Method 106)

Ten cycles with no voltage applied.

Thermal Shock (MIL-STD-202 Method 107, Condition A)

Immersion Cycling (MIL-STD-202 Method 104, Condition B)

Resistance To Solder Heat (MIL-STD-202, Method 210, Condition B, for 20 seconds)

Not RoHS Compliant

HOW TO ORDER

AVX Styles: SMX1, SMX2, SMX3, SMX4, SMX5, SMX6

SMX	1	7	C	106	M	A	N	650
AVX Style SMX = Uncoated	Size See Dimensions chart	Voltage 25 = 3 50V = 5 100V = 1 200V = 2 500V = 7	Temperature Coefficient C0G = A VHT/X7R = C	Capacitance Code (2 significant digits + number of zeros) 10 pF = 100 100 pF = 101 1,000 pF = 102 22,000 pF = 223 220,000 pF = 224 1 μF = 105 10 μF = 106 100 μF = 107	Capacitance Tolerance C0G: J = ±5% K = ±10% M = ±20% VHT/X7R: K = ±10% M = ±20% Z = +80%, -20%	Test Level A = Standard	Termination N = Straight Lead J = Leads formed in L = Leads formed out P = P Style Leads Z = Z Style Leads	Height Max Dimension "A" 120 = 0.120" 240 = 0.240" 360 = 0.360" 480 = 0.480" 650 = 0.650"

Note: Capacitors with VHT/X7R dielectric is not intended for applications across AC supply mains or AC line filtering with polarity reversal. Contact plant for recommendations.

SMPS Stacked MLC Capacitors

SMX Style for High Temperature Applications up to 200°C

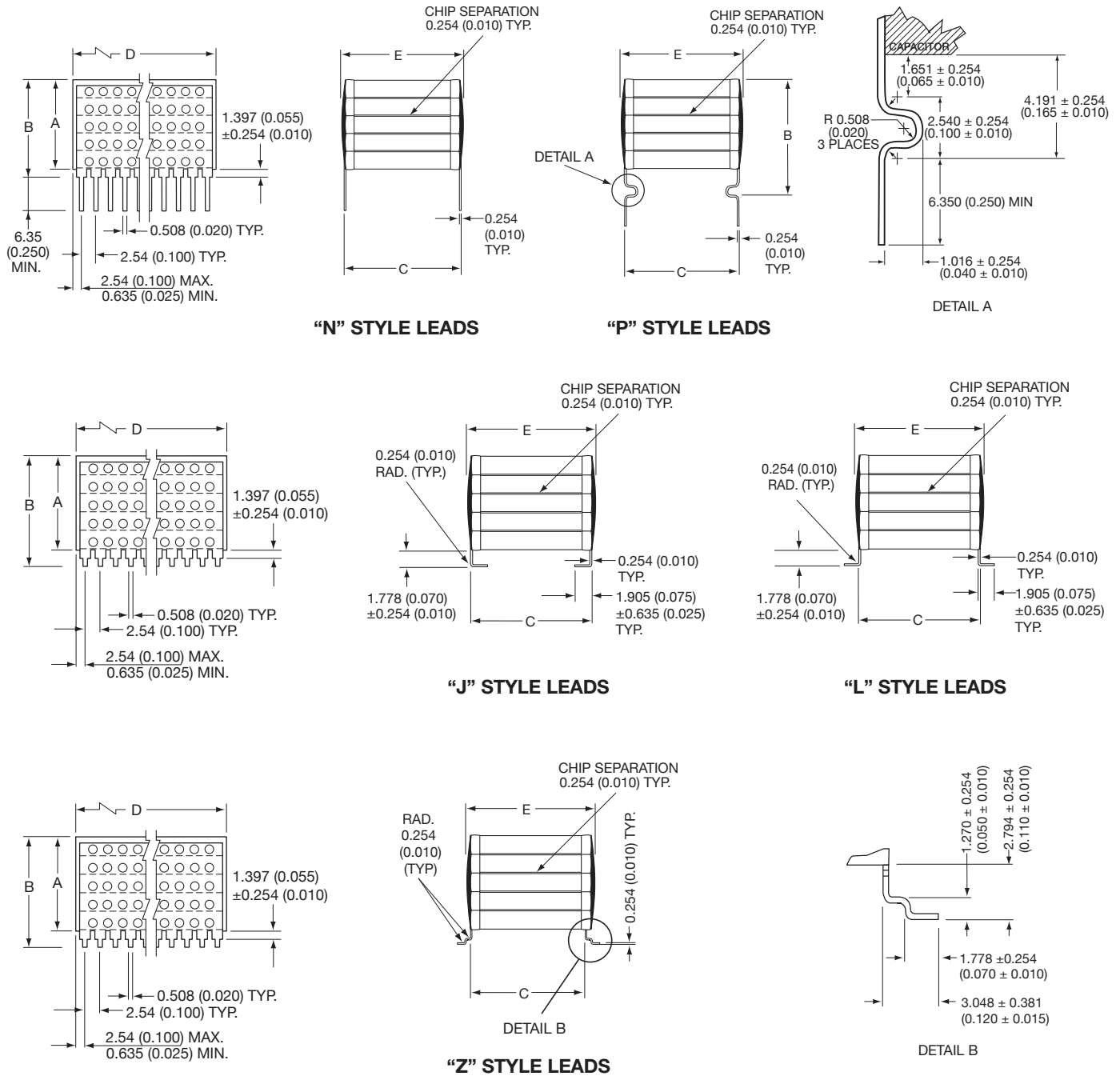

DIMENSIONS

millimeters (inches)

Style	A (max.)	B (max.)	C ±.635 (±0.025)	D ±.635 (±0.025)	E (max.)	No. of Leads per side
SMX1	See page 46 for maximum "A" Dimension	For "N" Style Leads: "A" Dimension Plus 1.651 (0.065) For "J" & "L" Style Leads: "A" Dimension Plus 2.032 (0.080) For "P" Style Leads: "A" Dimension Plus 4.445 (0.175) For "Z" Style Leads: "A" Dimension Plus 3.048 (0.120)	11.4 (0.450)	52.1 (2.050)	12.7 (0.500)	20
SMX2			20.3 (0.800)	38.4 (1.510)	22.1 (0.870)	15
SMX3			11.4 (0.450)	26.7 (1.050)	12.7 (0.500)	10
SMX4			10.2 (0.400)	10.2 (0.400)	11.2 (0.440)	4
SMX5			6.35 (0.250)	6.35 (0.250)	7.62 (0.300)	3
SMX6			31.8 (1.250)	52.1 (2.050)	34.3 (1.350)	20

SMPS Stacked MLC Capacitors

SMX Style for High Temperature Applications up to 200°C



Max Capacitance (µF) Available Versus Style with Height (A) of 0.120" - 3.05mm

AVX STYLE	SMX1 AN120					SMX2 AN120					SMX3 AN120					SMX4 AN120					SMX5 AN120					SMX6 AN120									
	25V	50V	100V	200V	500V	25V	50V	100V	200V	500V	25V	50V	100V	200V	500V	25V	50V	100V	200V	500V	25V	50V	100V	200V	500V	25V	50V	100V	200V	500V	25V	50V	100V	200V	500V
COG	1.0	.70	.40	.18	.068	1.2	1.0	.60	.26	.10	.50	.40	.20	.09	.033	.16	.13	.07	.02	.01	.05	.04	.02	.01	.0039	3.2	2.4	1.3	.50	.20					
VHT/X7R	-	18	10	3.9	1.8	-	27	15	5.6	2.7	12	8.2	4.7	1.8	.82	3.9	2.7	1.5	.56	.27	1.5	1.0	.56	.22	.10	-	56	33	12	5.6					

Max Capacitance (µF) Available Versus Style with Height (A) of 0.240" - 6.10mm

AVX STYLE	SMX1 AN240					SMX2 AN240					SMX3 AN240					SMX4 AN240					SMX5 AN240					SMX6 AN240									
	25V	50V	100V	200V	500V	25V	50V	100V	200V	500V	25V	50V	100V	200V	500V	25V	50V	100V	200V	500V	25V	50V	100V	200V	500V	25V	50V	100V	200V	500V					
COG	2.0	1.4	.80	.36	.13	2.4	2.0	1.2	.52	.20	1.0	.80	.40	.18	.068	.33	.26	.14	.05	.02	.10	.08	.05	.02	.0078	6.4	4.8	2.6	1.0	.40					
VHT/X7R	-	33	18	6.8	3.3	-	47	27	10	4.7	22	15	8.2	3.3	1.5	6.8	4.7	2.7	1.0	.47	2.7	1.8	1.0	.39	.18	-	100	56	22	10					

Max Capacitance (µF) Available Versus Style with Height (A) of 0.360" - 9.14mm

AVX STYLE	SMX1 AN360					SMX2 AN360					SMX3 AN360					SMX4 AN360					SMX5 AN360					SMX6 AN360									
	25V	50V	100V	200V	500V	25V	50V	100V	200V	500V	25V	50V	100V	200V	500V	25V	50V	100V	200V	500V	25V	50V	100V	200V	500V	25V	50V	100V	200V	500V					
COG	3.0	2.1	1.2	.54	.22	3.6	3.0	1.8	.78	.30	1.5	1.2	.60	.27	.10	.48	.39	.21	.07	.03	.15	.12	.07	.03	.011	10	7.2	3.9	1.5	.60					
VHT/X7R	-	47	27	10	4.7	-	68	39	15	6.8	33	22	12	5.6	2.2	12	6.8	3.9	1.5	.68	3.9	2.7	1.5	.56	.27	-	150	82	33	15					

Max Capacitance (µF) Available Versus Style with Height (A) of 0.480" - 12.2mm

AVX STYLE	SMX1 AN480					SMX2 AN480					SMX3 AN480					SMX4 AN480					SMX5 AN480					SMX6 AN480									
	25V	50V	100V	200V	500V	25V	50V	100V	200V	500V	25V	50V	100V	200V	500V	25V	50V	100V	200V	500V	25V	50V	100V	200V	500V	25V	50V	100V	200V	500V					
COG	4.0	2.8	1.6	.72	.27	4.8	4.0	2.2	1.0	.40	2.0	1.6	.80	.36	.130	.64	.52	.28	.10	.04	.20	.16	.10	.04	.015	13	9.6	5.2	2.0	.80					
VHT/X7R	-	68	39	15	6.8	-	100	56	22	10	47	33	18	6.8	3.3	15	10	5.6	2.2	1.0	5.6	3.9	2.2	.82	.39	-	220	120	47	22					

Max Capacitance (µF) Available Versus Style with Height (A) of 0.650" - 16.5mm

AVX STYLE	SMX1 AN650					SMX2 AN650					SMX3 AN650					SMX4 AN650					SMX5 AN650					SMX6 AN650									
	25V	50V	100V	200V	500V	25V	50V	100V	200V	500V	25V	50V	100V	200V	500V	25V	50V	100V	200V	500V	25V	50V	100V	200V	500V	25V	50V	100V	200V	500V					
COG	5.0	3.5	2.0	.90	.34	6.0	5.0	3.0	1.3	.50	2.5	2.0	1.0	.45	.160	.82	.65	.35	.12	.05	.25	.20	.12	.05	.019	16	12	6.5	2.5	1.0					
VHT/X7R	-	82	47	18	8.2	-	120	68	27	12	56	39	22	8.2	3.9	18	12	6.8	2.7	1.2	6.8	4.7	2.7	1.0	.47	-	270	150	56	27					

SMPS Capacitors Chip Assemblies

CH/CV - Radial, Dual-in-Line, 4 Terminal/SMT 'J' & 'L' Ranges

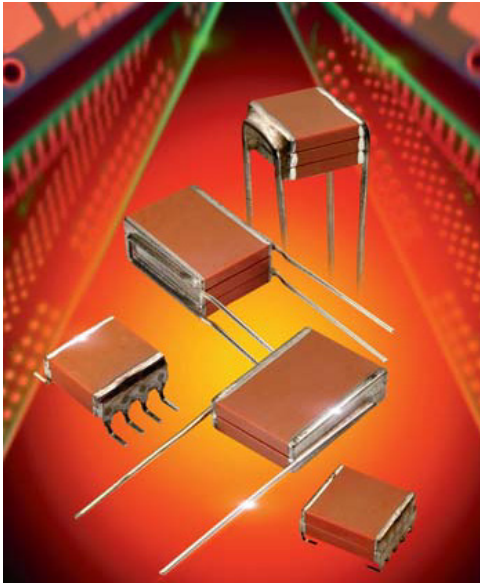

The CH/CV range exhibits low ESR/ESL making them well suited for high frequency applications. With its' PME technology, the range exhibits high current handling capabilities where as other technologies may not, making them the ideal choice for filtering, smoothing and decoupling circuit applications.

The CH/CV range uses a number of different lead frames types which reduces the thermo-mechanical stresses which makes them the designer's choice for high reliability applications. In combination with this the range uses a stacked capacitor design which saves on PCB space.

FEATURES

- BS9100 approved
- Voltage range 50-500 V DC
- Dielectrics 2C1/X7R
- Customised ceramic capacitor packages and lead frames available.

Note: AVX does not recommend or advise the use of adhesives to secure the CH/CV components to the PCB

ELECTRICAL SPECIFICATIONS

Temperature Coefficient CECC 30 000, (4.24.1)

2C1/X7R: C Temperature Characteristic - $\pm 15\%$, -55° to +125°C

Capacitance Test 25°C

2C1/X7R: Measured at 1 VRMS max at 1KHz

Dissipation Factor 25°C

2C1/X7R: 2.5% max at 1KHz, 1 VRMS max

Insulation Resistance 25°C

2C1/X7R: 100K megohms or 1000 megohms- μ F, whichever is less

Dielectric Withstanding Voltage 25°C (Flash Test)

2C1/X7R: 250% rated voltage for 5 seconds with 50 mA max charging current. (500 Volt units @ 150% rated voltage)

Life Test (1000 hrs) CECC 30 000 (4.23)

2C1/X7R: 200% rated voltage at +125°C.
(500 Volt units @ 120% rated voltage)

Damp Heat IEC 68-2-3, 56 days.

Thermal Shock IEC 68-2-14

-55°C to +125°C, 5 cycles

Resistance to Solder Heat IEC 68-2-20

Vibration IEC 68-2-6

10Hz - 2000Hz, 0.75mm or 98m/sec², 6 hrs.

Bump IEC 68-2-29

390m/sec², 4000 bumps

MARKING

CH and CV 4x, 5x, 81-84

A5C
225K
xxxxxx

Top line A (AVX). Voltage code, dielectric code.
Middle line capacitance code, tolerance code.
Bottom line 6 digit batch code.

Other CH, CV Styles

AVX
5C
156M
xxxxxx

Top line AVX.
Second line voltage code, dielectric code.
Third line capacitance code, tolerance code.
Bottom line, 6 digit batch code.

Performance of SMPS capacitors can be simulated by downloading SpiCalci software program -
<http://www.avx.com/download/software/SpiCalci-AVX.zip>
Custom values, ratings and configurations are also available.

SMPS Capacitors (CV Style)

Chip Assemblies



VERTICALLY MOUNTED RADIAL PRODUCT

Part Number format (CVxxxxxxxxxxA2)

Typical Part Number CV525C106MA30A2

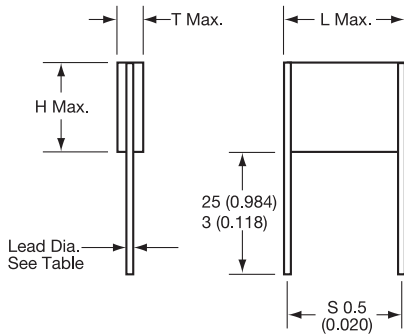

DIMENSIONS

millimeters (inches)

Style	L (max)	H (max)	S (nom)	Lead Dia (nom)
CV41-44	10.6 (0.417)	8.7 (0.342)	8.2 (0.322)	0.7 (0.028)
CV51-54	11.9 (0.468)	10.7 (0.421)	10.2 (0.400)	0.9 (0.035)
CV61-64	16.5 (0.649)	13.6 (0.535)	15.2 (0.600)	0.9 (0.035)
CV71-74	17.8 (0.700)	21.6 (0.850)	15.2 (0.600)	0.9 (0.035)
CV76-79	22.7 (0.893)	16.6 (0.653)	21.2* (0.834)	0.9 (0.035)

*Tolerance ± 0.8

millimeters (inches)

Style	T max
CV41/51/61/71/76	3.80 (0.150)
CV42/52/62/72/77	7.40 (0.291)
CV43/53/63/73/78	11.1 (0.437)
CV44/54/64/74/79	14.8 (0.583)

VERTICALLY MOUNTED 4 TERMINAL RADIAL PRODUCT

Part Number format (CVxxxxxxxx3xx4)

Typical Part Number CV435C106MA30A4

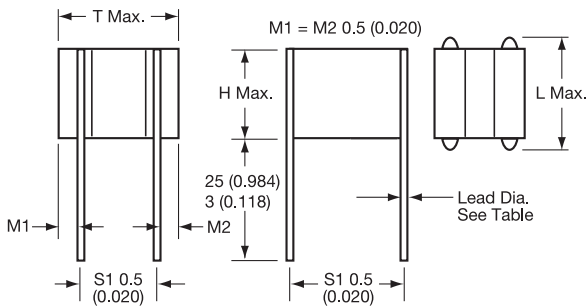

DIMENSIONS

millimeters (inches)

Style	L (max)	H (max)	S (nom)	Lead Dia (nom)
CV43-44	10.6 (0.417)	8.7 (0.342)	8.2 (0.322)	0.7 (0.028)
CV53-54	11.9 (0.468)	10.7 (0.421)	10.2 (0.400)	0.9 (0.035)
CV63-64	16.5 (0.649)	13.6 (0.535)	15.2 (0.600)	0.9 (0.035)
CV73-74	17.8 (0.700)	21.6 (0.850)	15.2 (0.600)	0.9 (0.035)
CV78-79	22.7 (0.893)	16.6 (0.653)	21.2* (0.834)	0.9 (0.035)

*Tolerance ± 0.8 (0.031)

millimeters (inches)

Style	T max	S1
CV43/53/63/73/78	11.1 (0.437)	5.08 (0.200)
CV44/54/64/74/79	14.8 (0.583)	7.62 (0.300)

Note 1. This style is only available in 3 & 4 chip assemblies

HOW TO ORDER

CV	52	5	C	106	M	A	3	0	A	2
Style Code (see product section)	Size Code	Voltage Code	Dielectric Code	Capacitance Code	Capacitance Tolerance	Specification Code	Finish Code	Lead Dia. Code	Lead Space Code	Lead Style Code
	5 = 50V 1 = 100V 2 = 200V 7 = 500V		C = X7R	(2 significant digits + no. of zeros) eg. 105 = 1 uF 106 = 10 uF 107 = 100 uF	X7R: K = ±10% M = ±20% = Non-customized P = +100, -0%		3 = Uncoated 8 = Coated (classified as uninsulated)	0 = Standard	A = Standard	2 = 2 Terminal 4 = 4 Terminal See Note 1 above

Not RoHS Compliant

Note: See page 139 for How to Order BS9100 parts



The Important Information/Disclaimer is incorporated in the catalog where these specifications came from or available online at www.avx.com/disclaimer/ by reference and should be reviewed in full before placing any order.

SMPS Capacitors (CH Style)

Chip Assemblies



HORIZONTALLY MOUNTED 4 TERMINAL RADIAL PRODUCT

Part Number format (CHxxxxxxxxx3xx4)

Typical Part Number CH782C106MA30A4

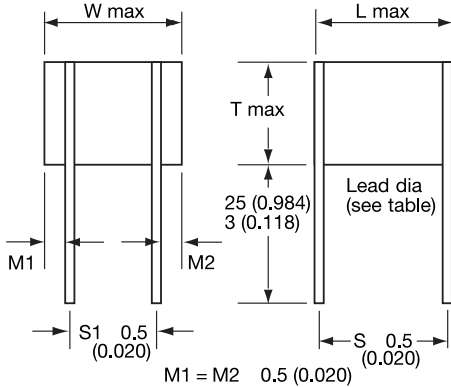

DIMENSIONS

millimeters (inches)

Style	L (max)	W (max)	S (nom)	S Lead Dia (nom)	S1 (nom)
CH42-44	10.6 (0.417)	8.7 (0.342)	8.2 (0.322)	0.7 (0.028)	5.08 (0.200)
CH52-54	11.9 (0.468)	10.7 (0.421)	10.2 (0.400)	0.9 (0.035)	7.62 (0.300)
CH62-64	16.5 (0.649)	13.6 (0.535)	15.2 (0.600)	0.9 (0.035)	7.62 (0.300)
CH72-74	17.8 (0.700)	21.6 (0.850)	15.2 (0.600)	0.9 (0.035)	15.2 (0.600)
CH77-79	22.7 (0.893)	16.6 (0.653)	21.2* (0.834)	0.9 (0.035)	10.2 (0.400)
CH82-84	14.1 (0.555)	38.2 (1.503)	10.2 (0.400)	0.9 (0.035)	27.9 (1.100)
CH87-89	17.8 (0.700)	38.2 (1.503)	15.2 (0.600)	1.0 (0.039)	27.9 (1.100)
CH92-94	24.0 (0.944)	40.6 (1.598)	21.2* (0.834)	1.2 (0.047)	30.5 (1.200)

*Tolerance ± 0.8

NOTE: This style is only available in 2, 3 & 4 chip assemblies only

millimeters (inches)

Style	T max
CH42/52/62/72/77/87/92	7.4 (0.291)
CH43/53/63/73/78/88/93	11.1 (0.437)
CH44/54/64/74/79/89/94	14.8 (0.583)

HORIZONTALLY MOUNTED DUAL-IN-LINE PRODUCT

Part Number format (CHxxxxxxxxx0A0)

Typical Part Number CH615C106MA30A0

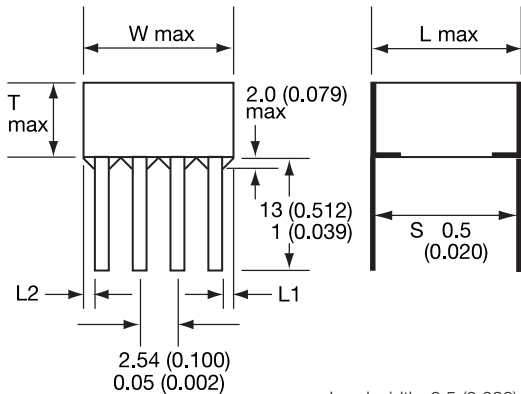

Lead width 0.5 (0.020)
Lead thickness 0.254 (0.010)
L1 = L2 ± 0.5 (0.020)

DIMENSIONS

millimeters (inches)

Style	L (max)	W (max)	S (nom)	No. of Leads per side
CH41-44	9.2 (0.362)	8.7 (0.342)	8.2 (0.322)	3
CH51-54	10.7 (0.421)	10.7 (0.421)	10.2 (0.400)	4
CH61-64	14.9 (0.586)	13.6 (0.535)	14.0 (0.551)	5
CH71-74	16.8 (0.661)	21.6 (0.850)	15.2 (0.600)	7
CH76-79	21.6 (0.850)	16.6 (0.653)	20.3* (0.800)	6
CH81-84	12.0 (0.472)	38.2 (1.503)	10.2 (0.400)	14
CH86-89	18.9 (0.744)	38.2 (1.503)	15.2 (0.600)	14
CH91-94	24.0 (0.944)	40.6 (1.598)	20.3* (0.800)	14

*Tolerance ± 0.8 (0.031)

millimeters (inches)

Style	T max
CH41/51/61/71/76/81/86/91	3.8 (0.150)
CH42/52/62/72/77/82/87/92	7.4 (0.291)
CH43/53/63/73/78/83/88/93	11.1 (0.437)
CH44/54/64/74/79/84/89/94	14.8 (0.583)

HOW TO ORDER

CH	52	5	C	106	M	A	3	0	A	0
Style Code (see product section)	Size Code	Voltage Code 5 = 50V 1 = 100V 2 = 200V 7 = 500V	Dielectric Code C = X7R	Capacitance Code (2 significant digits + no. of zeros) eg. 105 = 1 uF 106 = 10 uF 107 = 100 uF	Capacitance Tolerance Specification Code X7R: K = ±10% M = ±20% = Non-customized P = +10%, -0%	Finish Code 3 = Uncoated 8 = Coated (classified as uninsulated)	Lead Dia. Code 0 = Standard	Lead Space Code A = Standard	Lead Style Code 0 = Straight dual in line 4 = 4 Terminal	

Not RoHS Compliant

Note: See page 139 for How to Order BS9100 parts

SMPS Capacitors (CH Style)

Chip Assemblies



HORIZONTALLY MOUNTED 'L' LEAD SMT PRODUCT

Part Number format (CHxxxxxxxxxx0A7)

Typical Part Number CH411C275KA30A7

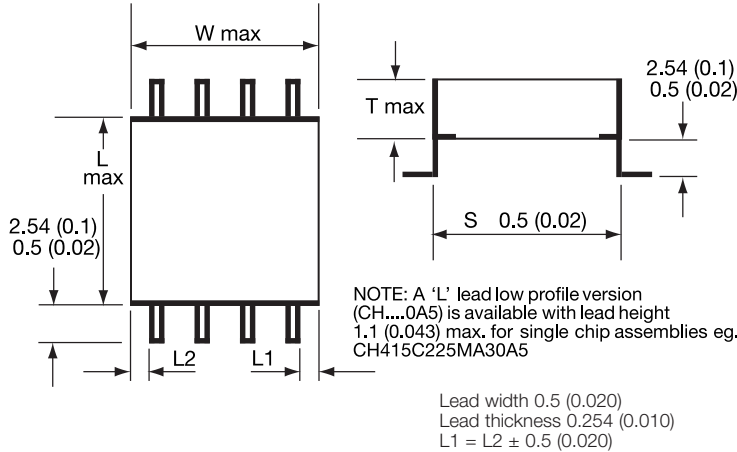

DIMENSIONS

millimeters (inches)

Style	L (max)	W (max)	S (nom)	No. of Leads per side
CH41-44	9.2 (0.362)	8.7 (0.342)	8.2 (0.322)	3
CH51-54	10.7 (0.421)	10.7 (0.421)	10.2 (0.400)	4
CH61-64	14.9 (0.586)	13.6 (0.535)	14.0 (0.551)	5
CH71-74	16.8 (0.661)	21.6 (0.850)	15.2 (0.600)	7
CH76-79	21.6 (0.850)	16.6 (0.653)	20.3* (0.800)	6
CH81-84	12.0 (0.472)	38.2 (1.503)	10.2 (0.400)	14
CH86-89	18.9 (0.744)	38.2 (1.503)	15.2 (0.600)	14
CH91-94	24.0 (0.944)	40.6 (1.598)	20.3* (0.800)	14

*Tolerance ± 0.8 (0.031)

millimeters (inches)

Style	T max
CH41/51/61/71/76/81/86/91	3.8 (0.150)
CH42/52/62/72/77/82/87/92	7.4 (0.291)
CH43/53/63/73/78/83/88/93	11.1 (0.437)
CH44/54/64/74/79/84/89/94	14.8 (0.583)

HORIZONTALLY MOUNTED 'J' LEAD SMT PRODUCT

Part Number format (CHxxxxxxxxxx0A8)

Typical Part Number CH411C275KA30A8

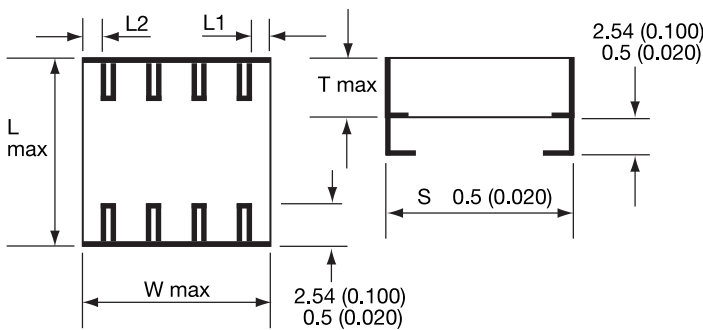

NOTE: A 'J' lead low profile version (CH...0A3) is available with lead height 1.1 (0.043) max. for single chip assemblies eg. CH515C475MA30A3

Lead width 0.5 (0.020)
Lead thickness 0.254 (0.010)
L1 = L2 ± 0.5 (0.020)

DIMENSIONS

millimeters (inches)

Style	L (max)	W (max)	S (nom)	No. of Leads per side
CH41-44	9.2 (0.362)	8.7 (0.342)	8.2 (0.322)	3
CH51-54	10.7 (0.421)	10.7 (0.421)	10.2 (0.400)	4
CH61-64	14.9 (0.586)	13.6 (0.535)	14.0 (0.551)	5
CH71-74	16.8 (0.661)	21.6 (0.850)	15.2 (0.600)	7
CH76-79	21.6 (0.850)	16.6 (0.653)	20.3* (0.800)	6
CH81-84	12.0 (0.472)	38.2 (1.503)	10.2 (0.400)	14
CH86-89	18.9 (0.744)	38.2 (1.503)	15.2 (0.600)	14
CH91-94	24.0 (0.944)	40.6 (1.598)	20.3* (0.800)	14

*Tolerance ± 0.8 (0.031)

millimeters (inches)

Style	T max
CH41/51/61/71/76/81/86/91	3.8 (0.150)
CH42/52/62/72/77/82/87/92	7.4 (0.291)
CH43/53/63/73/78/83/88/93	11.1 (0.437)
CH44/54/64/74/79/84/89/94	14.8 (0.583)

HOW TO ORDER

CH	52	5	C	106	M	A	3	0	A	7
Style Code (see product section)	Size Code 5 = 50V 1 = 100V 2 = 200V 7 = 500V	Voltage Code	Dielectric Code C = X7R	Capacitance Code (2 significant digits + no. of zeros) eg. 105 = 1 uF 106 = 10 uF 107 = 100 uF	Capacitance Tolerance X7R: K = ±10% M = ±20% P = +100, -0%	Specification Code Non-customized	Finish Code 3 = Uncoated 8 = Coated (classified as uninsulated)	Lead Dia. Code 0 = Standard	Lead Space Code A = Standard	Lead Style Code 3 = Low profile 'J' (single chip) 5 = Low profile 'L' (single chip) 7 = 'L' Dual in line 8 = 'J' Dual in line

Note: See page 139 for How to Order BS9100 parts

Not RoHS Compliant



The Important Information/Disclaimer is incorporated in the catalog where these specifications came from or available online at www.avx.com/disclaimer/ by reference and should be reviewed in full before placing any order.

SMPS Capacitors (CH/CV Style)

Chip Assemblies



X7R DIELECTRIC STABLE CERAMIC

Cap μ F	CH/CV41-44 Styles				CH/CV51-54 Styles				CH/CV61-64 Styles				CH/CV71-74 Styles				CH/CV76-79 Styles				CH81-84 Styles				CH86-89 Styles				CH91-94 Styles			
	50	100	200	500	50	100	200	500	50	100	200	500	50	100	200	500	50	100	200	500	50	100	200	500	50	100	200	500	50	100	200	500
Voltage DC																																
0.12			41																													
0.15			41																													
0.18			41																													
0.22			41																													
0.27			42								51																					
0.33			41	42							51																					
0.39			41	42							51																					
0.47			41	42							51																					
0.56			41	43							52																					
0.68			42	43							51	52																				
0.82			42	44							51	52																				
1			41	42	44						51	53																				
1.2			41	42							52	53																				
1.5			41	43							52	54																				
1.8	41	41	43								52																					
2.2	41	41	44								51	52																				
2.7	41	41									51	53																				
3.3	41	42									51	53																				
3.9	42	42									51	54																				
4.7	42	42									51	52																				
5.6	42	42									51	52																				
6.8	42	43									51	52																				
8.2	43	43									52	52																				
10	43	44									52	53																				
12	44										53	53																				
15											53	54																				
18											54																					
22											54																					
27																																
33																																
39																																
47																																
56																																
68																																
82																																
100																																
120																																
150																																
180																																

NB Figures in cells refer to size within ordering information

SMPS Molded Radial MLC Capacitors

SXP Style for High Temperature Applications up to 200°C

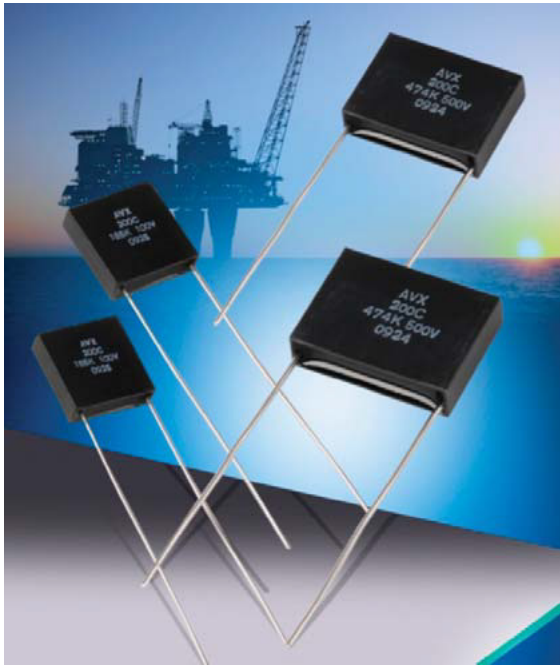

SXP-style, encapsulated radial leaded MLC capacitors are ideally suited for high temperature applications up to 200°C. This product is intended for downhole oil exploration, including logging while drilling, geophysical probes, as well as space, aerospace and hybrid automotive applications. This product supplements the SMX family of capacitors and offers mechanical protection to the ceramic element in extreme harsh environment. The high temperature solder utilized in the construction of SXP-style parts assures reliable operation in high temperature and rugged environments. The SXP-style capacitors are ideally suited for applications as DC filters in high power, high frequency motor drives, high pulsed-current circuitry, as well as standard electronic equipment designed for high temperature applications.

SXP-style, switch mode power supply capacitors are characterized with excellent performance. The main benefits of SXP product include:

- Low ESR, low ESL
- Low DC leakage
- Excellent high frequency performance

HOW TO ORDER

SXP	3	1	C	104	M	A	A
AVX Style	Size See Dimensions chart	Voltage Code 50V = 5 100V = 1 200V = 2 500V = 7 1000V = A 1500V = S 2000V = G 3000V = H	Temperature Coefficient COG = A VHT/X7R = C	Capacitance Code (2 significant digits + number of zeros) 100 pF = 101 22,000 pF = 223 1µF = 105	Capacitance Tolerance COG: J = ±5% K = ±10% M = ±20% VHT/X7R: K = ±10% M = ±20% Z = +80%, -20%	Test Level A = Standard	Leads A = Standard Sn/Pb (min. 5% Pb)
					Tighter tolerances available upon request		

Not RoHS Compliant

ELECTRICAL SPECIFICATIONS

Temperature Coefficient

COG: A Temperature Coefficient 0 ±30 ppm/°C, -55° to +200°C
 VHT/X7R: C Temperature Coefficient ±15%, -55°C to +125°C
 +15% - 56%, -55°C to +200°C

Capacitance Test (MIL-STD-202 Method 305)

25°C, 1.0±0.2 Vrms (open circuit voltage) at 1KHz

Dissipation Factor 25°C

COG: 0.15% Max @ 25°C, 1.0±0.2 Vrms (open circuit voltage) at 1KHz
 VHT/X7R: 2.5% Max @ 25°C, 1.0±0.2 Vrms (open circuit voltage) at 1KHz

Insulation Resistance 25°C (MIL-STD-202 Method 302)

100K MΩ or 1000 MΩ-µF, whichever is less.

Insulation Resistance 125°C (MIL-STD-202 Method 302)

10K MΩ or 100 MΩ-µF, whichever is less.

Insulation Resistance 200°C (MIL-STD-202 Method 302)

1K MΩ or 10 MΩ -µF, whichever is less.

Dielectric Withstanding Voltage 25°C (Flash Test)

250% rated voltage for 5 seconds with 50 mA max charging current. (150% for 500 VDC and 120% for 1000 VDC and higher voltage ratings)

SMPS Molded Radial MLC Capacitors

SXP Style for High Temperature Applications up to 200°C

STYLE

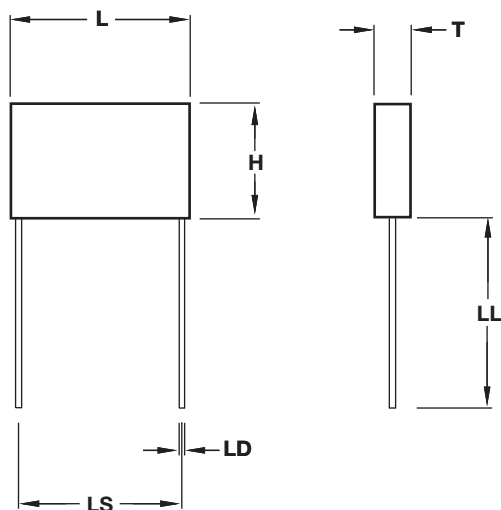

DIMENSIONS

millimeters (inches)

AVX Style	Length (L) ±0.25 (±0.010)	Height (H) ±0.25 (±0.010)	Thickness (T) ±0.25 (±0.010)	Lead Spacing ±0.76 (±0.030)	LD ±0.05 (±0.002)	LL
SXP1	8.9 (0.350)	8.9 (0.350)	5.08 (0.200)	5.08 (0.200)	0.51 (0.020)	25.4 (1.000)
SXP2	11.4 (0.450)	11.4 (0.450)	5.08 (0.200)	5.08 (0.200)	0.51 (0.020)	
SXP3	12.7 (0.500)	12.7 (0.500)	5.08 (0.200)	10.2 (0.400)	0.64 (0.025)	
SXP4	22.4 (0.880)	16.3 (0.640)	5.84 (0.230)	19.8 (0.780)	0.81 (0.032)	

CAPACITANCE RANGE

COG

Style	50V	100V	200V	500V	1000V	1500V	2000V	3000V
SXP1	(MIN)	1000pF	1000pF	1000pF	100pF	100pF	100pF	100pF
	(MAX)	.047μF	.027μF	8200pF	4700pF	2200pF	1000pF	560pF
SXP2	(MIN)	.01μF	1000pF	1000pF	100pF	100pF	100pF	100pF
	(MAX)	.10μF	.056μF	.018μF	8200pF	4700pF	1800pF	1200pF
SXP3	(MIN)	.01μF	1000pF	1000pF	1000pF	100pF	100pF	100pF
	(MAX)	.15μF	.068μF	.022pF	.012pF	6800pF	2700pF	1500pF
SXP4	(MIN)	.01μF	.01μF	1000pF	1000pF	1000pF	1000pF	100pF
	(MAX)	.39μF	.22μF	.068pF	.033pF	.018μF	8200pF	4700pF

VHT/X7R

Style	50V	100V	200V	500V	1000V	1500V	2000V	3000V
SXP1	(MIN)	.1μF	.01μF	.01μF	.01μF	.01μF	.01μF	1000pF
	(MAX)	1.5μF	1.0μF	.33μF	.12μF	.056μF	.022μF	.012μF
SXP2	(MIN)	.1μF	.1μF	.01μF	.01μF	.01μF	.01μF	.01μF
	(MAX)	2.7μF	1.8μF	.68μF	.27μF	.10μF	.056μF	.022μF
SXP3	(MIN)	.01μF	.1μF	.01μF	.01μF	.01μF	.01μF	.01μF
	(MAX)	3.9μF	2.7μF	1.0μF	.33μF	.15μF	.082μF	.033μF
SXP4	(MIN)	1μF	.1μF	.1μF	.01μF	.01μF	.01μF	.01μF
	(MAX)	12μF	8.2μF	2.7μF	1.0μF	.47μF	.22μF	.10μF

High-CV SMPS Capacitors

TurboCap™

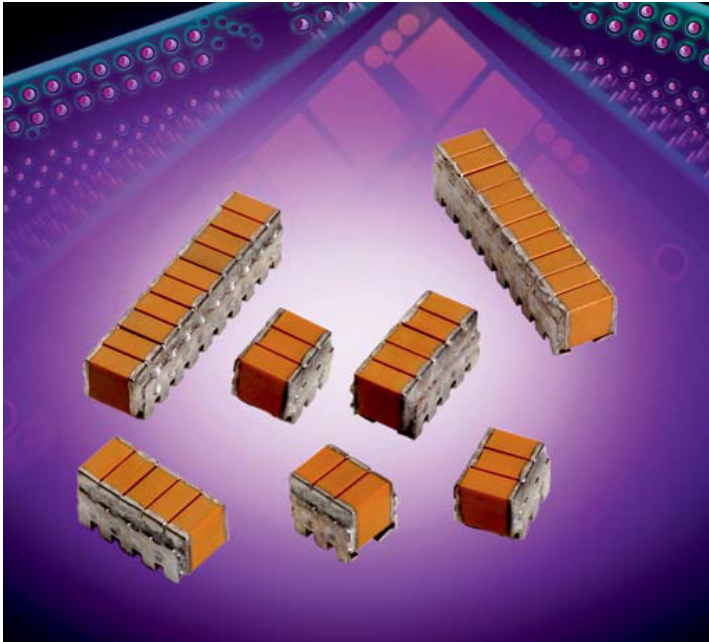

The TurboCap™, MLC capacitors from AVX Corporation are characterized with very high capacitance in a small volume. By vertical stacking of the ceramic elements, the footprint required for mounting the capacitors is greatly reduced. TurboCaps™ are ideally suited as filters in the input and output stages of switch mode power supplies (SMPS). With their ultra-low ESR, these capacitors are designed to handle high ripple current at high frequencies and high power levels. The DIP leads in either thru-hole or surface mount configurations offer superior stress relief to the ceramic elements. The leads effectively decouple the parts from the board and minimize thermally or mechanically induced stresses encountered during assembly, temperature cycling or other environmental conditions.

TYPICAL APPLICATION OF TURBOCAP™ SMPS CAPACITORS FOR INPUT AND OUTPUT FILTERS IN DC/DC CONVERTERS

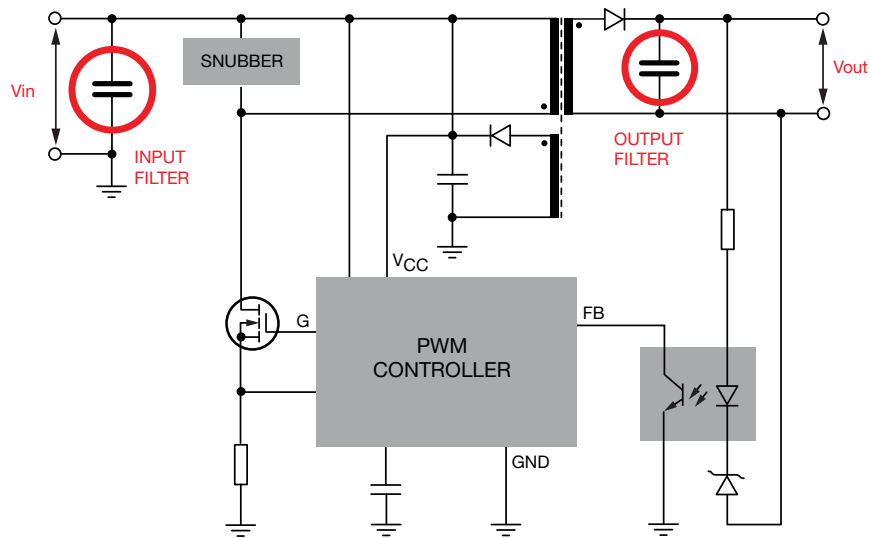

Performance of SMPS capacitors can be simulated by downloading SpiCalci software program - <http://www.avx.com/download/software/SpiCalci-AVX.zip>
Custom values, ratings and configurations are also available.

High-CV SMPS Capacitors

TurboCap™



ELECTRICAL SPECIFICATIONS

Temperature Coefficient

Temperature Coefficient ±15%, -55° to +125°C

Capacitance Test (MIL-STD-202 Method 305)

25°C, 1.0±0.2 Vrms (open circuit voltage) at 1KHz

Dissipation Factor 25°C

2.5% Max @ 25°C, 1.0±0.2 Vrms (open circuit voltage) at 1KHz

Insulation Resistance 25°C (MIL-STD-202 Method 302)

500 MΩ-μF, whichever is less.

Insulation Resistance 125°C (MIL-STD-202 Method 302)

50 MΩ-μF, whichever is less.

Dielectric Withstanding Voltage 25°C (Flash Test)

250% rated voltage for 5 seconds with 50 mA max charging current.

Life Test (1000 hrs)

X7R: 150% rated voltage at +125°C.

Moisture Resistance (MIL-STD-202 Method 106)

Ten cycles with no voltage applied.

Thermal Shock (MIL-STD-202 Method 107, Condition A)

Immersion Cycling (MIL-STD-202 Method 104, Condition B)

Resistance To Solder Heat (MIL-STD-202, Method 210, Condition B, for 20 seconds)

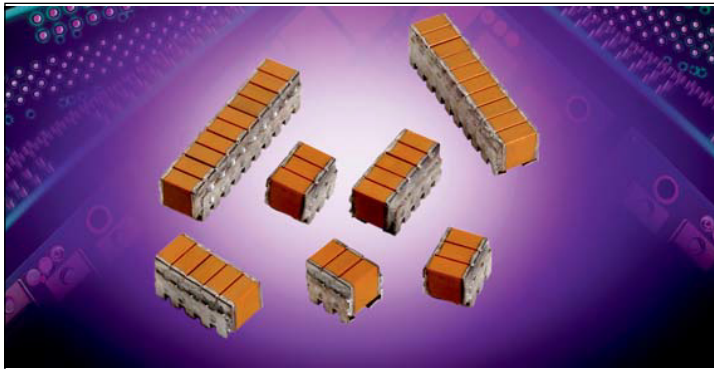

Typical ESR Performance (Ω)			
	27μF	47μF	100μF
ESR @ 10KHz	0.007	0.004	0.003
ESR @ 50KHz	0.003	0.002	0.0015
ESR @ 100KHz	0.002	0.0015	0.001

Not RoHS Compliant

HOW TO ORDER

AVX Styles: ST12 and ST20

ST12

AVX Style
ST12
ST20

5

Voltage
25V = 3
50V = 5
100V = 1

C

Temperature Coefficient
X7R = C

186

Capacitance Code
(2 significant digits + number of zeros)
1 μF = 105
10 μF = 106
100 μF = 107

M

Capacitance Tolerance
M = ±20%

A

Test Level
A = Standard

N

Termination
N = Straight Lead
J = Leads formed in
L = Leads formed out

03

Number of Leads Per Side
03 = 3
05 = 5
10 = 10

CAPACITANCE (MF)

Cap (μF)	ST12			ST20	
	Voltage				
	50V	100V	25V	50V	100V
.82					
1.3					
2.7					
8.2		...03			
12		...05			
14					...03
18	...03				
22		...10			...05
27	...05			...03	
47				...05	...10
50	...10				
68			...03		
100			...05	...10	
220			...10		

High-CV SMPS Capacitors

TurboCap™

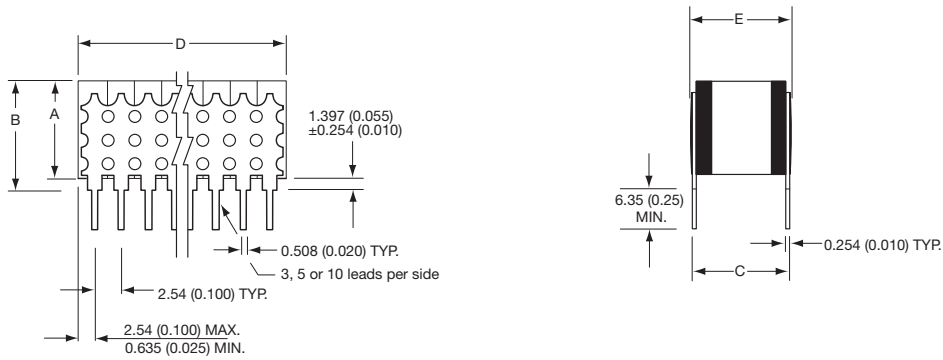

“N” STYLE LEADS

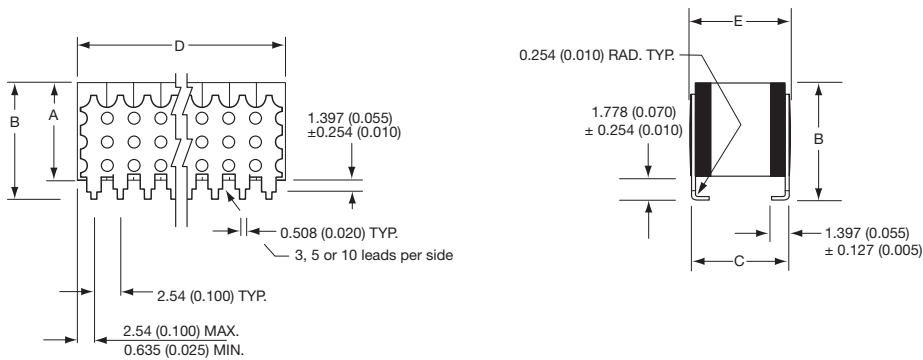

“J” STYLE LEADS

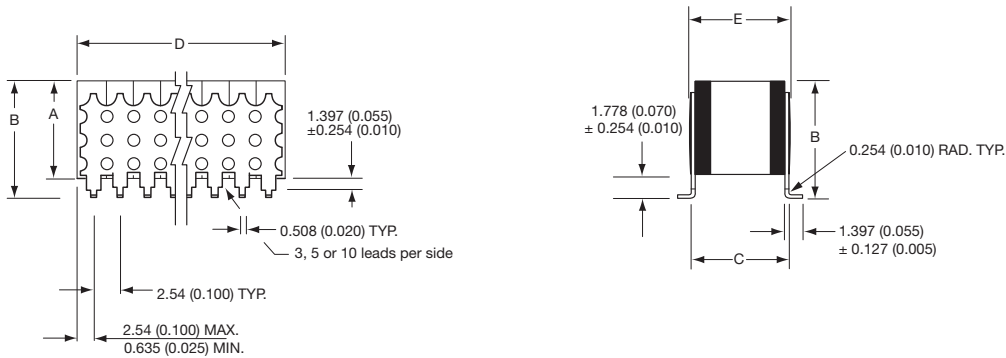

“L” STYLE LEADS

DIMENSIONS

millimeters (inches)

Style	A (max.)	B (max.)*	C ± 0.635 (± 0.025)	D (max.)	E (max.)	Lead Style	No. of Leads Per Side
ST125C***M*N03	3.56 (0.140)	5.21 (0.205)	5.08 (0.200)	10.8 (0.425)	6.35 (0.250)	N	03
ST125C***M*N05	3.56 (0.140)	5.21 (0.205)	5.08 (0.200)	15.9 (0.625)	6.35 (0.250)	N	05
ST125C***M*N10	3.56 (0.140)	5.21 (0.205)	5.08 (0.200)	27.9 (1.100)	6.35 (0.250)	N	10
ST205C***M*N03	5.59 (0.220)	7.24 (0.285)	6.35 (0.250)	9.5 (0.375)	7.62 (0.300)	N	03
ST205C***M*N05	5.59 (0.220)	7.24 (0.285)	6.35 (0.250)	14.6 (0.575)	7.62 (0.300)	N	05
ST205C***M*N10	5.59 (0.220)	7.24 (0.285)	6.35 (0.250)	27.3 (1.075)	7.62 (0.300)	N	10

*The "B" dimension is defined for the "N" Style leads. The "L" and "J" Style Leads are 0.381 (0.015) longer. The ST12 will be 5.89 (0.220), the ST20 will be 7.62 (0.300).

High-CV SMPS Capacitors

RoHS Compliant TurboCap™

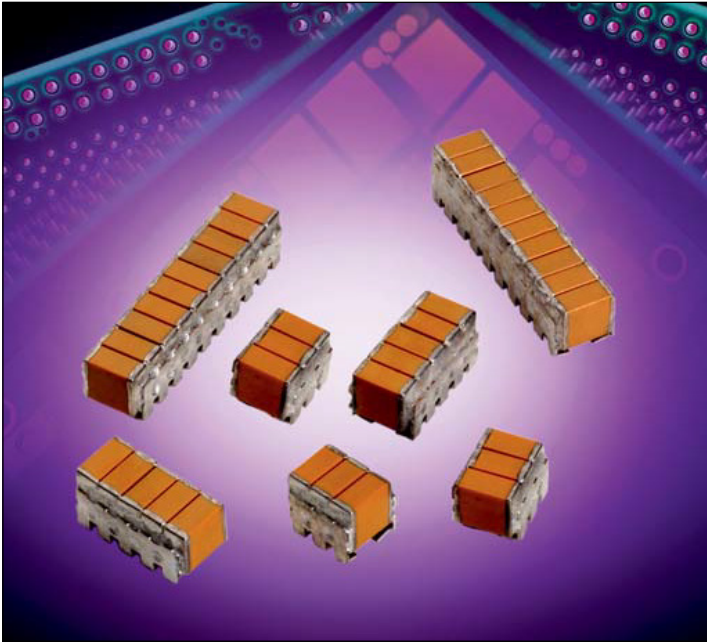

The RoHS Compliant TurboCap™, MLC capacitors from AVX Corporation are characterized with very high capacitance in a small volume. By vertical stacking of the ceramic elements, the footprint required for mounting the capacitors is greatly reduced. TurboCaps™ are ideally suited as filters in the input and output stages of switch mode power supplies (SMPS). With their ultra-low ESR, these capacitors are designed to handle high ripple current at high frequencies and high power levels. The DIP leads in either thru-hole or surface mount configurations offer superior stress relief to the ceramic elements. The leads effectively decouple the parts from the board and minimize thermally or mechanically induced stresses encountered during assembly, temperature cycling or other environmental conditions.

TYPICAL APPLICATION OF TURBOCAP™ SMPS CAPACITORS FOR INPUT AND OUTPUT FILTERS IN DC/DC CONVERTERS

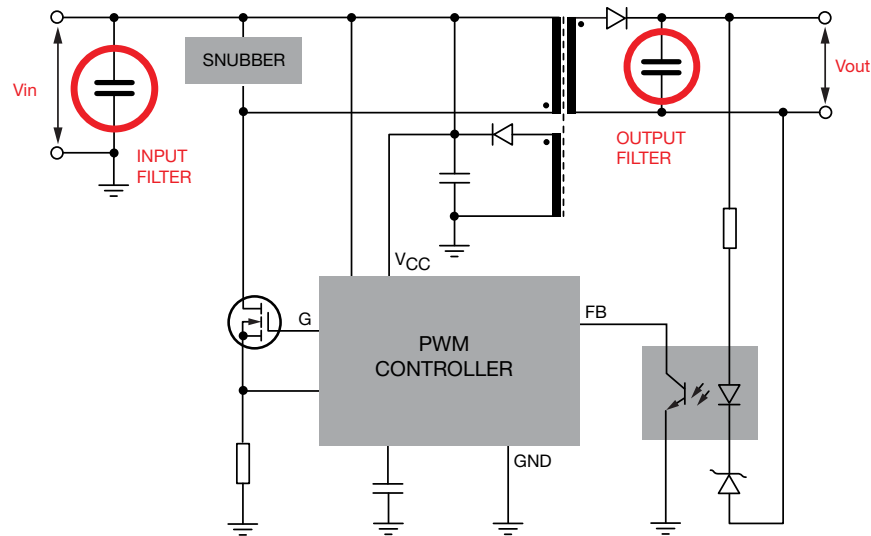

Performance of SMPS capacitors can be simulated by downloading SpiCalci software program - <http://www.avx.com/download/software/SpiCalci-AVX.zip>
Custom values, ratings and configurations are also available.

High-CV SMPS Capacitors

RoHS Compliant TurboCap™



ELECTRICAL SPECIFICATIONS

Temperature Coefficient

Temperature Coefficient ±15%, -55° to +125°C

Capacitance Test (MIL-STD-202 Method 305)

25°C, 1.0±0.2 Vrms (open circuit voltage) at 1KHz

Dissipation Factor 25°C

2.5% Max @ 25°C, 1.0±0.2 Vrms (open circuit voltage) at 1KHz

Insulation Resistance 25°C (MIL-STD-202 Method 302)

50 MΩ-μF, whichever is less.

Insulation Resistance 125°C (MIL-STD-202 Method 302)

50 MΩ-μF, whichever is less.

Dielectric Withstanding Voltage 25°C (Flash Test)

250% rated voltage for 5 seconds with 50 mA max charging current.

Life Test (1000 hrs)

X7R: 150% rated voltage at +125°C.

Moisture Resistance (MIL-STD-202 Method 106)

Ten cycles with no voltage applied.

Thermal Shock (MIL-STD-202 Method 107, Condition A)

Immersion Cycling (MIL-STD-202 Method 104, Condition B)

Resistance To Solder Heat (MIL-STD-202, Method 210, Condition B, for 20 seconds)

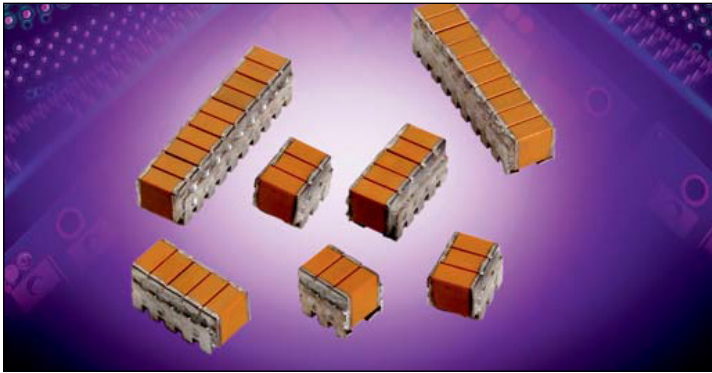

Typical ESR Performance (Ω)			
	27μF	47μF	100μF
ESR @ 10KHz	0.007	0.004	0.003
ESR @ 50KHz	0.003	0.002	0.0015
ESR @ 100KHz	0.002	0.0015	0.001



HOW TO ORDER

RT12

AVX Style
RT12
RT20

5

Voltage
25V = 3
50V = 5
100V = 1

C

Temperature Coefficient
X7R = C

186

Capacitance Code
(2 significant digits + number of zeros)
1 μF = 105
10 μF = 106
100 μF = 107

M

Capacitance Tolerance
M = ±20%

A

Test Level
A = Standard

N

Termination
N = Straight Lead
J = Leads formed in
L = Leads formed out

03

Number of Leads Per Side
03 = 3
05 = 5
10 = 10

AVX Styles: RT12 and RT20

CAPACITANCE (MF)

Cap (μF)	RT12			RT20	
	Voltage				
	50V	100V	25V	50V	100V
.82					
1.3					
2.7					
8.2		...03			
12		...05			
14					...03
18	...03				
22		...10			...05
27	...05			...03	
47				...05	...10
50	...10				
68			...03		
100			...05	...10	
220			...10		



The Important Information/Disclaimer is incorporated in the catalog where these specifications came from or available online at www.avx.com/disclaimer/ by reference and should be reviewed in full before placing any order.

High-CV SMPS Capacitors

RoHS Compliant TurboCap™

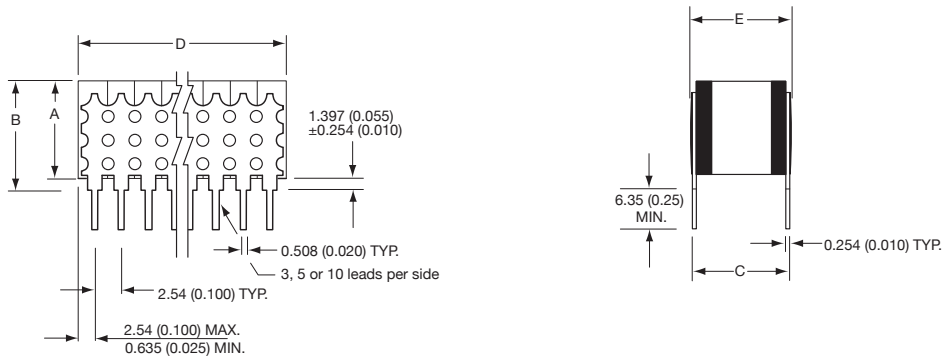

“N” STYLE LEADS

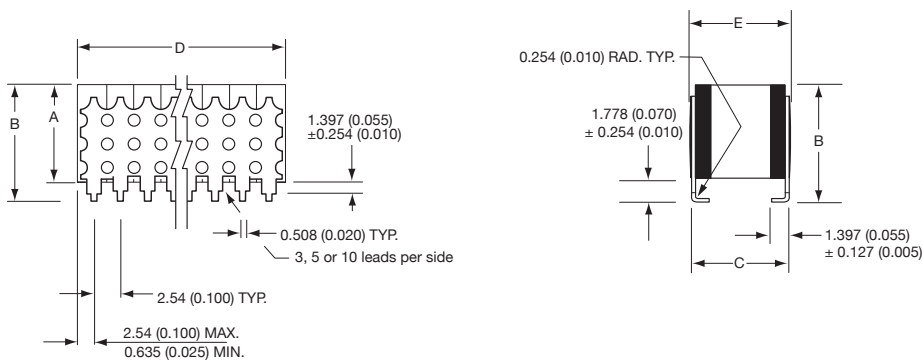

“J” STYLE LEADS

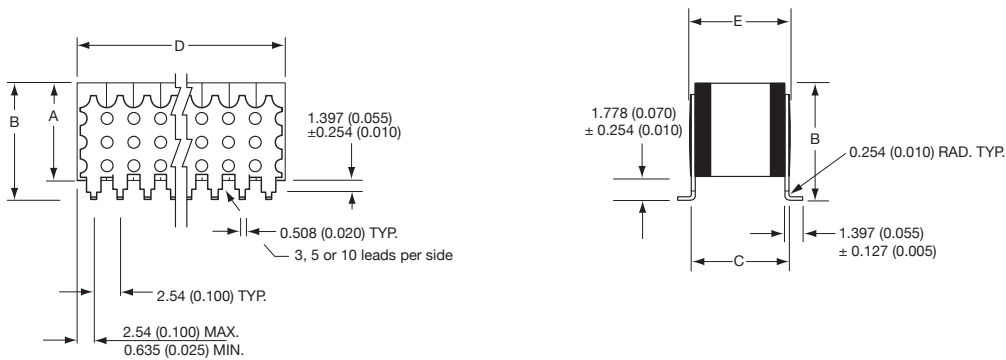

“L” STYLE LEADS

DIMENSIONS

millimeters (inches)

Style	A (max.)	B (max.)*	C ± 0.635 (± 0.025)	D (max.)	E (max.)	Lead Style	No. of Leads Per Side
RT125C***M*N03	3.56 (0.140)	5.21 (0.205)	5.08 (0.200)	10.8 (0.425)	6.35 (0.250)	N	03
RT125C***M*N05	3.56 (0.140)	5.21 (0.205)	5.08 (0.200)	15.9 (0.625)	6.35 (0.250)	N	05
RT125C***M*N10	3.56 (0.140)	5.21 (0.205)	5.08 (0.200)	27.9 (1.100)	6.35 (0.250)	N	10
RT205C***M*N03	5.59 (0.220)	7.24 (0.285)	6.35 (0.250)	9.50 (0.375)	7.62 (0.300)	N	03
RT205C***M*N05	5.59 (0.220)	7.24 (0.285)	6.35 (0.250)	14.6 (0.575)	7.62 (0.300)	N	05
RT205C***M*N10	5.59 (0.220)	7.24 (0.285)	6.35 (0.250)	27.3 (1.075)	7.62 (0.300)	N	10

*The “B” dimension is defined for the “N” Style leads. The “L” and “J” Style Leads are 0.381 (0.015) longer. The RT12 will be 5.89 (0.220), the RT20 will be 7.62 (0.300).

Small Footprint, High Volumetric Efficiency, High-CV

SMPS Capacitors

Mini-TurboCap™



The Mini-TurboCap is constructed from state-of-the-art BME (Base Metal Electrode) MLC Capacitors achieving very high CV, as well as, ultra low ESR and ESL. The resulting, very large capacitance values allow for component and board space reduction. Stress relieving lead frames provide effective mechanical decoupling of the ceramic chips from the board, minimizing the stress created by board flexing, vibration and temperature cycling. High temperature solder is used to attach chips to the lead frame thus eliminating the risk of solder reflow during assembly to the board.

CAPACITANCE (MF)

Cap (µF)	Voltage		
	25V	50V	100V
8.2			
18			
39*			
82*			

Not RoHS Compliant

HOW TO ORDER

ST10	5	C	186	M	A	K	02
AVX Style	Voltage 25V = 3 50V = 5 100V = 1	Temperature Coefficient X7R = C	Capacitance Code (2 significant digits + number of zeros) 1 µF = 105 10 µF = 106	Capacitance Tolerance M = ±20%	Test Level A = Standard	Termination N = Straight Lead K = Leads formed in M = Leads formed out	Number of Leads Per Side 02 = 2

Additional stacked/lead configurations available upon request. Consult with AVX factory personnel for details.

ELECTRICAL SPECIFICATIONS

Temperature Coefficient
±15%, -55° to +125°C

Capacitance Test (MIL-STD-202, Method 305)
25°C, 1.0±0.2 Vrms (open circuit voltage) at 1KHz

Dissipation Factor
5% Max @ 25°C, for 50VDC and 100VDC voltage ratings

Insulation Resistance 25°C (MIL-STD-202, Method 302)
500 MΩ-µF (*100 MΩ-µF)

Insulation Resistance 125°C (MIL-STD-202, Method 302)
50 MΩ-µF (*10 MΩ-µF)

Dielectric Withstanding Voltage 25°C (Flash Test)
250% rated voltage for 5 seconds with 50 mA max charging current.

Life Test Capabilities (1000 hrs)
150% rated voltage at +125°C.



Small Footprint, High Volumetric Efficiency, High-CV

SMPS Capacitors

Mini-TurboCap™



STYLE/DIMENSIONS

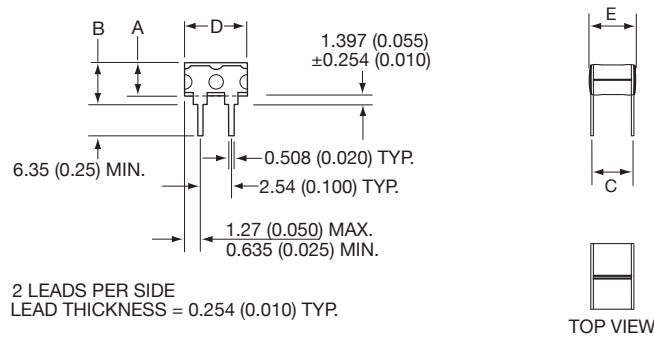

“N” STYLE LEADS

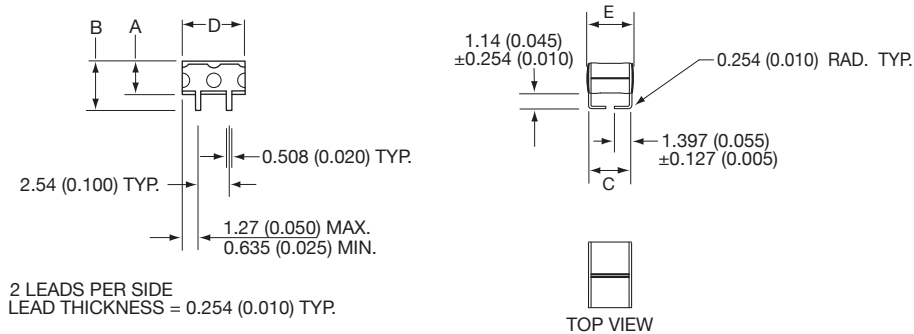

“K” STYLE LEADS

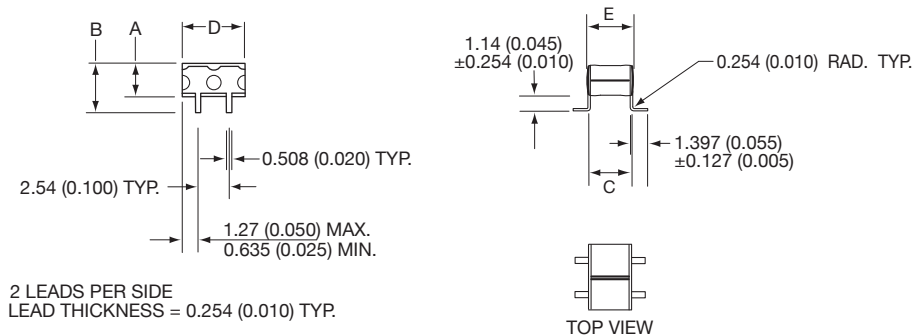

“M” STYLE LEADS

DIMENSIONS

millimeters (inches)

Style	A (max.)	B (max.)	C ± 0.635 (± 0.025)	D ± 0.635 (± 0.025)	E (max.)	No. of Leads Per Side
ST10	5.59 (0.220)	7.00 (0.275)	3.81 (0.150)	5.33 (0.210)	4.83 (0.190)	02

PART NUMBER AVAILABLE OPTIONS (2X2)

Part Number	Temperature Coefficient	Voltage	Capacitance Code	Capacitance	Capacitance Tolerance	Number Of Leads	Lead Styles
ST103C826MA-02	X7R	25	826	82µF	±20%	2	N, K, M
ST105C186MA-02	X7R	50	186	18µF	±20%	2	N, K, M
ST105C396MA-02	X7R	50	396	39µF	±20%	2	N, K, M
ST101C825MA-02	X7R	100	825	8.2µF	±20%	2	N, K, M

Small Footprint, High Volumetric Efficiency, High-CV

SMPS Capacitors

RoHS Compliant Mini-TurboCap™



The RoHS Compliant Mini-TurboCap™ is constructed from state-of-the-art BME (Base Metal Electrode) MLC Capacitors achieving very high CV, as well as, ultra low ESR and ESL. The resulting, very large capacitance values allow for component and board space reduction. Stress relieving lead frames provide effective mechanical decoupling of the ceramic chips from the board, minimizing the stress created by board flexing, vibration and temperature cycling. High temperature solder is used to attach chips to the lead frame thus eliminating the risk of solder reflow during assembly to the board.

CAPACITANCE RANGE

Cap (µF)	Voltage		
	25V	50V	100V
8.2			
18			
39*			
82*			



HOW TO ORDER

RT10

AVX Style

5

Voltage
25V = 3
50V = 5
100V = 1

C

Temperature Coefficient
X7R = C

186

Capacitance Code
(2 significant digits + number of zeros)
1 µF = 105
10 µF = 106

M

Capacitance Tolerance
M = ±20%

A

Test Level
A = Standard

K

Termination
N = Straight Lead
K = Leads formed in
M = Leads formed out

02

Number of Leads Per Side
02 = 2

Additional stacked/lead configurations available upon request. Consult with AVX factory personnel for details.

ELECTRICAL SPECIFICATIONS

Temperature Coefficient

±15%, -55° to +125°C

Capacitance Test (MIL-STD-202, Method 305)

25°C, 1.0±0.2 Vrms (open circuit voltage) at 1KHz

Dissipation Factor

5% Max @ 25°C, for 50VDC and 100VDC voltage ratings

Insulation Resistance 25°C (MIL-STD-202, Method 302)

500 MΩ-µF (*100 MΩ-µF)

Insulation Resistance 125°C (MIL-STD-202, Method 302)

50 MΩ-µF (*10 MΩ-µF)

Dielectric Withstanding Voltage 25°C (Flash Test)

250% rated voltage for 5 seconds with 50 mA max charging current.

Life Test Capabilities (1000 hrs)

150% rated voltage at +125°C.



The Important Information/Disclaimer is incorporated in the catalog where these specifications came from or available online at www.avx.com/disclaimer/ by reference and should be reviewed in full before placing any order.

Small Footprint, High Volumetric Efficiency, High-CV

SMPS Capacitors

RoHS Compliant Mini-TurboCap™



STYLE/DIMENSIONS

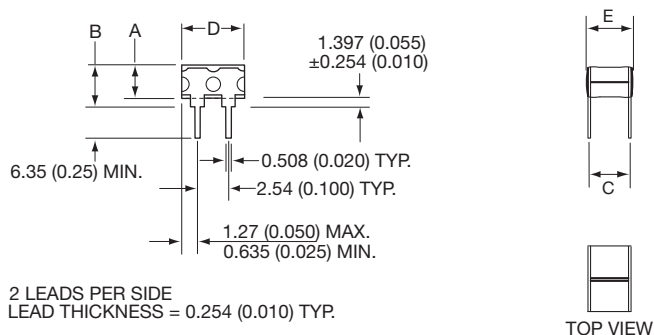

“N” STYLE LEADS

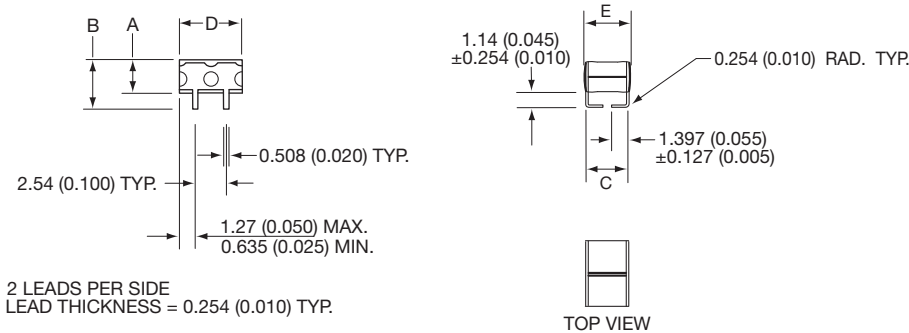

“K” STYLE LEADS

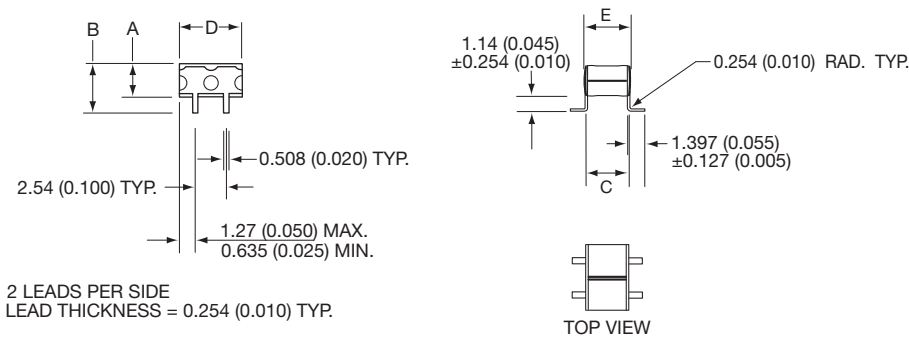

“M” STYLE LEADS

DIMENSIONS

millimeters (inches)

Style	A (max.)	B (max.)	C ± 0.635 (± 0.025)	D ± 0.635 (± 0.025)	E (max.)	No. of Leads Per Side
RT10	5.59 (0.220)	7.00 (0.275)	3.81 (0.150)	5.33 (0.210)	4.83 (0.190)	02

PART NUMBER AVAILABLE OPTIONS (2X2)

Part Number	Temperature Coefficient	Voltage	Capacitance Code	Capacitance	Capacitance Tolerance	Number Of Leads	Lead Styles
RT103C826MA-02	X7R	25	826	82µF	±20%	2	N, K, M
RT105C186MA-02	X7R	50	186	18µF	±20%	2	N, K, M
RT105C396MA-02	X7R	50	396	39µF	±20%	2	N, K, M
RT101C825MA-02	X7R	100	825	8.2µF	±20%	2	N, K, M

Lead Free Ceramic Capacitor in Molded

SM Leadframe

MH Style Ceramic Capacitor



The MH components use a X7R high capacitance value ceramic capacitor in a surface mount precision made moulded case.

The MH capacitor combine the ceramic attributes of very low ESR, non-polar construction, excellent high frequency behaviour and voltage stress capabilities and wide temperature range; with the enhanced mechanical protection of a moulded case. The moulded case is UL94 V-0 flame retardant and the MH is RoHs and also AEC-Q200 compliant.

The MH range provides a lead frame solution to customers who have previously been unable to use large case ceramic capacitors because of mechanical stressing concerns.

For those applications where a tin termination is not acceptable, a Tin/Lead termination is available.

FEATURES

- Capacitance: 2.2u F – 22 μF
- MHs are AEC-Q200 compliant
- Voltage Range DC: 25V – 100V
- Enhanced thermo mechanical stress resistance.

HOW TO ORDER

MH	V	1	1	C	475	M	A	T	2	A
MH Series	Case Size see table below	MLCC Count	Voltage 3 = 25V 5 = 50V 1 = 100V	Dielectric C = X7R	Capacitance Code (In pF) 2 Sig. Digits + Number of Zeros	Capacitance Tolerance K = ±10% M = ±20%	Failure Rate A = Not Applicable	Termination T = Tin Plated B = Tin/Lead Plated	Packaging 2 = 7" Reel 4 = 13" Reel 6 = Waffle Pack	Special Code A = Std. Product

MH X7R RANGE

	Cap μF	25V	50V	100V
225	2.2			
335	3.3			
475	4.7			
685	6.8			
106	10			
156	15			
226	22			

PACKAGING QUANTITY

7" Reels	400
13" Reels	1500
Waffle Pack	108

"V" CASE DIMENSIONS: MILLIMETERS (INCHES)

L	7.3±0.20 (0.287±0.008)
W	6.1 + 0.20 - 0.10 (0.24 + 0.008 - 0.004)
H	3.45±0.30 (0.136±0.012)
W₁	3.1±0.20 (0.120±0.008)
A	1.4 + 0.30 - 0.20 (0.055 + 0.012 - 0.008)
S Min	4.40 (0.173)

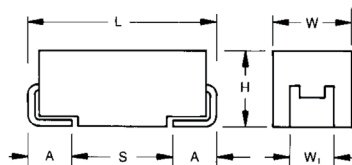

TS 16949, ISO 14001
Certified Manufacture

Performance of SMPS capacitors can be simulated by downloading SpiCalci software program - <http://www.avx.com/download/software/SpiCalci-AVX.zip>



The Important Information/Disclaimer is incorporated in the catalog where these specifications came from or available online at www.avx.com/disclaimer/ by reference and should be reviewed in full before placing any order.

SMPS Capacitors

RH Style - Surface Mount 'J' Lead Range

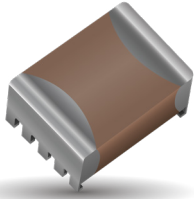

The RH range uses high volumetric efficient X7R capacitors in a "J" style lead frame.

The range of components are uncoated and are suitable for input or output filter capacitors in high frequency DC-DC convertor, automotive, telecom, industrial and military applications.

When large ceramic capacitors are used in applications they can easily be affected by stresses caused by temperature variations, thermal shock, mechanical vibrations and PCB bend movement. The RH range is designed with a "J" type lead frame which greatly reduces all of these thermo mechanical stresses experienced by large capacitors. The RH range allows the capacitors to be doubled stacked so a higher volumetric efficiency can be achieved by the customer and this saves PCB space.

FEATURES

- RH 21/22 are AEC-Q200 compliant.
- RH range has low ESR/ESL capability
- PCB space saving using double stacked MLCCs
- Enhanced thermo mechanical stress resistance

Note: AVX does not recommend or advise the use of adhesives to secure the RH components to the PCB.

ELECTRICAL SPECIFICATIONS

Temperature Coefficient CECC 30 000, (4.24.1)

X7R: C Temperature Characteristic - ± 15%, -55°C to +125°C

Capacitance Test

Measured at 1 VRMS max at 1KHz

Dissipation Factor 25°C

2.5% max at 1KHz, 1 VRMS max

Insulation Resistance 25°C

100K megohms or 1000 megohms-μF, whichever is less

Dielectric Withstanding Voltage 25°C (Flash Test)

250% rated voltage for 5 seconds with 50 mA max charging current. (500 Volt units @ 150% rated voltage)

Life Test (1000 hrs) CECC 30 000 (4.23)

200% rated voltage at +125°C.

(500 Volt units @ 120% rated voltage)

Thermal Shock IEC 68.2.14

-55°C to +125°C, 5 cycles

Resistance to Solder Heat IEC 68.2.20

Typical ESR (mΩ) 3 μF, 100V X7R	
ESR @ 100KHz	17
ESR @ 500KHz	12
ESR @ 1MHz	14

DIMENSIONS

millimeters (inches)

Style	L max	W max	H max	S ± 0.1 (±0.004)	h	No. of leads per side
RH21	7.20 (0.283)	5.40 (0.213)	4.60 (0.181)	2.50 (0.098)	1.50 ± 0.30 (0.059 ± 0.012)	2
RH22	7.20 (0.283)	5.40 (0.213)	7.50 (0.295)	2.50 (0.098)	1.50 ± 0.30 (0.059 ± 0.012)	2
RH31	7.62 (0.300)	7.00 (0.270)	5.08 (0.200)	5.08 (0.200)	1.78 ± 0.25 (0.070 ± 0.010)	3
RH32	7.62 (0.300)	7.00 (0.270)	8.13 (0.320)	5.08 (0.200)	1.78 ± 0.25 (0.070 ± 0.010)	3
RH41	9.20 (0.362)	8.70 (0.342)	4.90 (0.192)	5.08 (0.200)	1.60 ± 0.10 (0.062 ± 0.004)	3
RH42	9.20 (0.362)	8.70 (0.342)	8.20 (0.323)	5.08 (0.200)	1.60 ± 0.10 (0.062 ± 0.004)	3
RH51	10.7 (0.421)	10.7 (0.421)	4.90 (0.192)	7.62 (0.300)	1.60 ± 0.10 (0.062 ± 0.004)	4
RH52	10.7 (0.421)	10.7 (0.421)	8.20 (0.323)	7.62 (0.300)	1.60 ± 0.10 (0.062 ± 0.004)	4
RH61	14.9 (0.586)	13.6 (0.535)	4.90 (0.192)	10.2 (0.400)	1.60 ± 0.10 (0.062 ± 0.004)	5
RH62	14.9 (0.586)	13.6 (0.535)	8.20 (0.323)	10.2 (0.400)	1.60 ± 0.10 (0.062 ± 0.004)	5

DIMENSIONS: MILLIMETERS (INCHES)

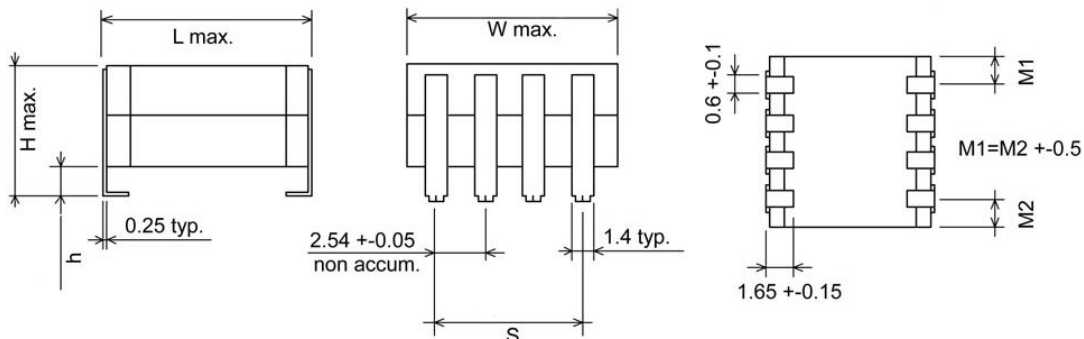

Performance of SMPS capacitors can be simulated by downloading SpiCalci software program - <http://www.avx.com/download/software/SpiCalci-AVX.zip>
 Custom values, ratings and configurations are also available.

SMPS Capacitors

RH Style - Surface Mount 'J' Lead Range



X7R STABLE DIELECTRIC

Cap μ F	RH21/RH22 Style				RH31/RH32 Style				RH41/RH42 Style				RH51/RH52 Style				RH61/RH62 Style			
	25	50	100	200	50	100	200	500	50	100	200	500	50	100	200	500	50	100	200	500
0.047																				
0.056																				
0.068											RH31									
0.082																				
0.1																				
0.12																				
0.15																				
0.18																				
0.22																				
0.27																				
0.33																				
0.39																				
0.47																				
0.56																				
0.68																				
0.78																				
0.82																				
1																				
1.2																				
1.5																				
1.8																				
2.2																				
3																				
3.3																				
3.9																				
4.7																				
6.8																				
8.2																				
10																				
12																				
15																				
18																				
22																				
33																				
47																				
68																				

BME
BME
PME
PME
BME Development

For availability of further parts in the RH21/RH22 Series, contact manufacturing.

PACKAGING

Style	Qty/Reel 13"	Max. Qty/Waffle Pack
RH21	800	270
RH22	500	270
RH31	800	108
RH32	500	108
RH41	see note	108
RH42	500	100
RH51	750	88
RH52	see note	88
RH61	500	42
RH62	see note	42

Note: T&R is not yet available. Contact manufacturing for further information as this will be available in the future.

BME Available in RoHS and Non-RoHS PME

Available Only in Non-RoHS



HOW TO ORDER

RH	31	5	C	225	M	A	3	0	A	3
Style Code (see table above)	Size Code	Voltage Code 3 = 25V 5 = 50V 1 = 100V 2 = 200V 7 = 500V	Dielectric Code C = X7R	Capacitance Code (2 significant digits + no. of zeros) eg. 105 = 1 μ F 104 = 0.1 μ F	Capacitance Tolerance K = \pm 10% M = \pm 20%	Specification Code A = Non-customized	Package Code 3 = Waffle Pack A = Tape & Reel	Lead Dia. Code 0 = Standard R = RoHS Compliant	Lead Space Code A = Standard	Lead Style Code 3 = 'J' Lead



The Important Information/Disclaimer is incorporated in the catalog where these specifications came from or available online at www.avx.com/disclaimer/ by reference and should be reviewed in full before placing any order.

SMPS Capacitors

Custom Geometries and Lead Configurations

For the requirements that cannot be satisfied by standard SMPS style products (SM0-style or SM9-style), AVX offers leading edge solutions in custom configuration and packaging. Ranging from unique geometries, lead configurations, packaging and stress relief mounting options, AVX has optimized solutions for a wide range of customer specific designs. The solutions provided by AVX maintain high reliability of stacked capacitor product originally developed by AVX and historically recognized as the highest reliability product in the market. Custom packaging options provide solutions that eliminate reliability concerns in the next level assembly. These custom options provide the following benefits:

- eliminate soldering requirements altogether by providing means

of electrical/mechanical connection to the circuit

- provide options for remote soldering away from large ceramic capacitor body and eliminating the risk of thermal shock (refer to photograph with soft, insulated leads soldered to the stacked capacitor using high melting point SN10 solder)

Many other innovations are available from AVX Corporation. Let them apply these ideas to your application specific requirements. Please contact AVX for a solution that will meet demands of your program requirements.

CUSTOM LEAD CONFIGURATIONS...

CUSTOM PACKAGING...



Reliability

AVX has been involved in numerous military and customer High Reliability programs for over 40 years.

Reliability [% Failure Rate (FR%) or Mean Time Between Failure (MTBF)] is based on the number of failures and the cumulative test hours expanded by test versus use acceleration factors. The acceleration factors are calculated according to the following relationships:

$$\text{Temperature Acceleration} = 10^{\left(\frac{T_T - T_U}{25}\right)}$$

Where:
 T_T = test temp. (°C)
 T_U = use temp. (°C)

$$\text{Voltage Acceleration} = \left(\frac{V_T}{V_U}\right)^3$$

Where:
 V_T = test voltage
 V_U = use voltage

Military Reliability levels are usually expressed in terms of rated conditions versus test conditions (generally 125°C and 2X WVDC). If actual conditions are less than rated, the reliability levels will improve significantly over rated and can be calculated by use of the above relationship for determining accelerated test hours. For example, if the actual use conditions were 75°C and 1/2 WVDC rating for a 125°C rated part, the acceleration factors are 64X for voltage and 100X for temperature. Reliabilities based on current testing can be obtained by contacting AVX.

General Processing Guidelines Soldering

The SM styles capacitors are generally quite large relative to other types of MLC capacitors. As a result of the size, precautions must be taken before subjecting the parts to any soldering operation in order to prevent thermal shock. Preheat prior to soldering is essential. The heating rate of the SupraCap® ceramic bodies during preheat must not exceed 4°C/second. The preheat temperature must be within 50°C of the peak temperature reached by the ceramic bodies, adjacent to lead material, through the soldering process. The leads are attached to the chip stack with 10 / 88 / 2 (Sn / Pb / Ag, Solidus 268°C, Liquidus 290°C).

Vibration Specifications*

Due to the weight of the SupraCap® and the size and strength of the lead frame used, when the SupraCap® is to be used in an application where it will undergo high frequency vibration, we strongly recommend using our potted SM9 styles SupraCap®.

If other DIP styles SupraCap® are to be used in a high frequency vibration environment, the SupraCap® should be supported in some way to prevent oscillation of the capacitor assembly which will result in lead breakage. If “strapping” the SupraCap® to the board is the chosen method of support, care should be taken not to chip the ceramic or apply undue pressure so that cracking of the ceramic results.

If bonding the SupraCap® to the board with adhesive, consideration of

the CTE (coefficient of thermal expansion) is necessary. A mismatch between the CTE of the ceramic and adhesive can cause the ceramic to crack during temperature cycles.

Processing Guidelines*

There are practical size limitations for MLCs which prohibit reliable direct mounting of chip capacitors larger than 2225 (.22” x .25”) to a substrate. These large chips are subject to thermal shock racking and thermal cycling solder joint fatigue. Even 1812 (.18” x .12”) and 2225 chip capacitors will have solder joint failures due to mechanical fatigue after ≈ 1500 thermal cycles from 0 to 85°C on FR4 and ≈ 3000 cycles on alumina from -55 to 125°C. This is due to differences in the Coefficient of Thermal Expansion (CTE) between MLCs and substrate materials used in hybrids and surface mount assemblies. Materials used in the manufacture of all electronic components and substrates have wide ranges of CTEs as shown in Table 1.

Table 1

CTEs of Typical Components and Substrates

Material	CTE (ppm/°C)
Alloy 42	5.3
Alumina	~7
Barium Titanate Capacitor Body	10-12
Copper	17.6
Copper Clad Invar	6-7
Filled Epoxy Resin (<TR)	18-25
FR4/G-10 PC Board (X, Y)	~18
Nickel or Steel	15
Polyimide/Glass PCB (X, Y)	~12
Polyimide/Kevlar PCB (X, Y)	~7
Tantalum	6.5
Tin Lead Alloys	~27

Linear Displacement

This CTE difference translates into mechanical stress that is due to the linear displacement of substrate and component. Linear displacement is a function of ΔCTE (CTE_{sub} - CTE_{comp}) and the overall length of the component. Long components/ substrates have large linear displacements even with a small ΔCTE which will cause high stress in the solder joints and fatigue after a few temperature cycles. Figure 1 shows linear displacement for conditions where ΔCTE is positive and negative.

* Reference AVX Technical Information paper, “Processing Guidelines for SMPS Capacitors.”

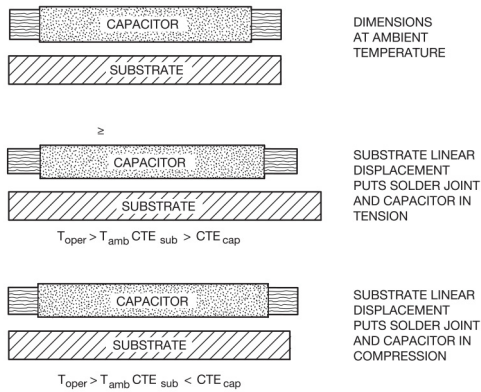

Figure 1. Linear Displacement Between Component and Substrate

General Processing Guidelines

Figure 2 shows the location of maximum stress in the solder joint due to positive and negative DCTE and linear displacement.

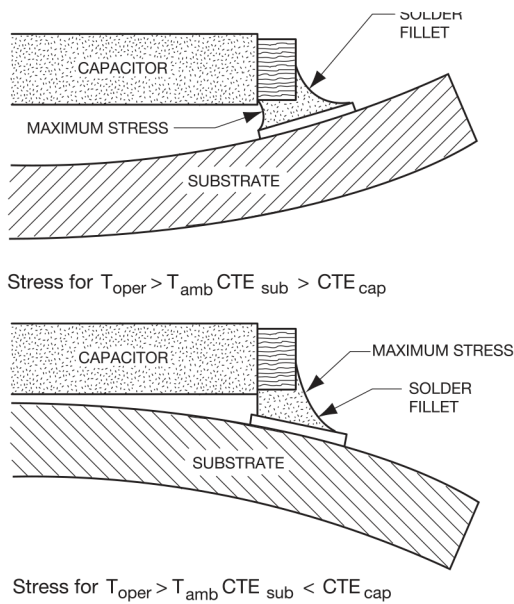

Figure 2

Stress Relief

Leadframes on larger capacitor sizes (greater than 2225) must be used to minimize mechanical stress on the solder joints during temperature cycling which is normal operation for power supplies (Figure 3). Failing solder joints increase both ESR and ESL causing an increase in ripple, noise and heat, accelerating failure.

Layout

Effective solder dams must be used to keep all molten solder on the solder lands during reflow or solder will migrate away from the land, causing opens or weak solder joints. High frequency output filters cannot use low power layout techniques such as necked down conductors because of the stringent inductance requirements.

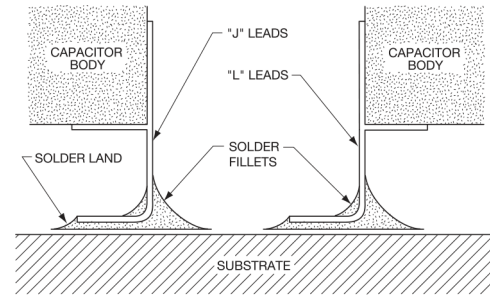

Figure 3. "J" and "L" Leadframes Mounted on Capacitors to Relieve Stress

Inductance

Adding leadframes has a small impact on component inductance but this is the price that must be paid for reliable operation over temperature. Figure 4 shows typical leadframe inductance that is added for two lead standoff distances (0.020" and 0.050") versus the number of leads along one side of SupraCap® which are specifically designed output filter capacitors for 1 MHz and above switchers. The actual inductance will be somewhat less because the leadframes flare out from the lead where the lead-frame is attached to the capacitor body.

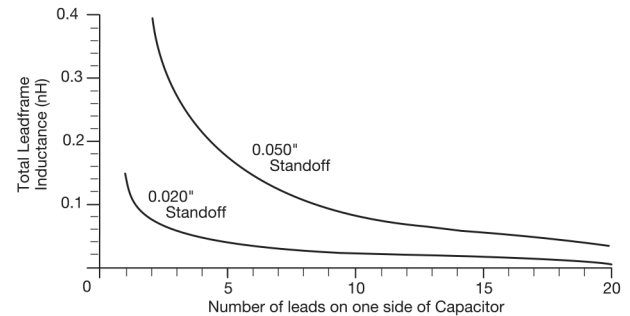

Figure 4. Number of Leads on One Side of Capacitor vs. Total Leadframe Inductance vs. Substrate Standoff Height

Very high frequency switch mode power supplies place tremendous restrictions on output filter capacitors. In addition to handling high ripple current (low ESR), ESL must approach zero nano henrys, part must be truly surface mountable and be available in new configurations to be integrated into transmission lines to further reduce inductance with load currents greater than 40A at 1 MHz and as frequencies move above 1-2 MHz.

The total inductance is the sum of each side of the part where the inductance of one side is the parallel combination of each lead in the leadframe. That inductance is given by:

$$L \text{ (nH)} = 5x\ell \left[\ln(2x\ell) / (B+C) + 1/2 \right]$$

Where ℓ = lead length in inches

\ln = natural log

$B+C$ = lead cross section in inches

so $L_1 \text{ (nH)} = 2xL \text{ (nH)}$ where L_1 is the total inductance of the leadframe.

SMPS Capacitors

SK Style – Commercial Radial Range

PRODUCT OFFERING – COG, N1500 AND X7R

AVX SK styles are conformally coated MLC capacitors for input or output filtering in switch mode power supplies. They are specially processed to handle high currents and are low enough in cost for commercial SMPS application.

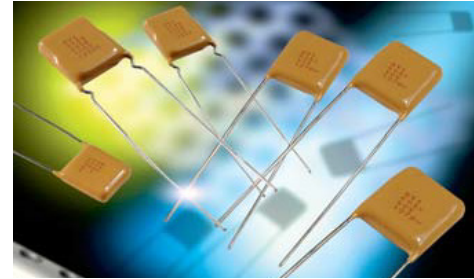

ELECTRICAL SPECIFICATIONS

Temperature Coefficient

COG: A Temperature Coefficient – 0 ± 30 ppm/°C, -55° to +125°C

N1500: 4 Temperature Coefficient – -1500 ± 250 ppm/°C

X7R: C Temperature Coefficient – $\pm 15\%$, -55° to +125°C

Capacitance Test (MIL-STD-202 Method 305)

COG, N1500: 25°C, 1.0 ± 0.2 Vrms (open circuit voltage) at 1KHz

X7R: 25°C, 1.0 ± 0.2 Vrms (open circuit voltage) at 1KHz

Dissipation Factor 25°C

COG, N1500: 0.15% Max @ 25°C, 1.0 ± 0.2 Vrms (open circuit voltage) at 1KHz

X7R: 2.5% Max @ 25°C, 1.0 ± 0.2 Vrms (open circuit voltage) at 1KHz

Insulation Resistance 25°C (MIL-STD-202 Method 302)

COG, N1500, X7R: 100K MΩ or 1000 MΩ-μF, whichever is less.

Insulation Resistance 125°C (MIL-STD-202 Method 302)

COG, N1500, X7R: 10K MΩ or 100 MΩ-μF, whichever is less.

Dielectric Withstanding Voltage 25°C (Flash Test)

COG, N1500, X7R: 250% rated voltage for 5 seconds with 50 mA max charging current. (500 Volt units @ 750 VDC)

Life Test (1000 hrs)

COG, N1500, X7R: 200% rated voltage at +125°C. (500 Volt units @ 600 VDC)

Moisture Resistance (MIL-STD-202 Method 106)

COG, N1500, X7R, Z5U: Ten cycles with no voltage applied.

Thermal Shock (MIL-STD-202 Method 107, Condition A)

Immersion Cycling (MIL-STD-202 Method 104, Condition B)

Resistance To Solder Heat (MIL-STD-202, Method 210, Condition B, for 20 seconds)

HOW TO ORDER

SK	01	3	C	394	Z	A	A	*
Style	Size See chart below	Voltage 25V = 3 50V = 5 100V = 1 200V = 2 500V = 7	Temperature Coefficient COG = A N1500 = 4 X7R = C	Capacitance Code (2 significant digits + no. of zeros) 22 nF = 223 220 nF = 224 1 μF = 105 100 μF = 107	Capacitance Tolerance COG, N1500: J = ±5% K = ±10% M = ±20% X7R: K = ±10% M = ±20% Z = +80, -20%	Test Level A = Standard B = Hi-Rel*	Leads A = Tin/Lead R = RoHS Compliant*	Packaging (See Note 1)

Note 1: No suffix signifies bulk packaging, which is AVX standard packaging. SK01, SK*3, SK*4, SK*5, SK*6, SK*9 & SK*0 are available taped and reel per EIA-468. Use suffix "TR1" if tape & reel is required.

Note 2: Capacitors with X7R dielectric are not intended for applications across AC supply mains or AC line filtering with polarity reversal. Contact plant for recommendations.

*Hi-Rel screening consists of 100% Group A (B Level), Subgroup 1 per MIL-PRF-49470.

TAPE & REEL QUANTITY	
Part	Pieces
SK01	2000
SK03/SK53	1000
SK04/SK54	1000
SK05/SK55	500
SK06/SK56	500
SK07	N/A
SK08	N/A
SK09/SK59	500
SK10/SK60	400

RoHS	
Part	Available
SK01	Yes
SK03/SK53	Yes
SK04/SK54	Yes
SK05/SK55	Yes
SK06/SK56	Yes
SK07	Yes
SK08	Yes
SK09/SK59	Yes
SK10/SK60	Yes

Not RoHS Compliant



For RoHS compliant products, please select correct termination style.

Performance of SMPS capacitors can be simulated by downloading SpiCalci software program - <http://www.avx.com/download/software/SpiCalci-AVX.zip>
Custom values, ratings and configurations are also available.

SMPS Capacitors

SK Style – Product Offering – COG, N1500, X7R

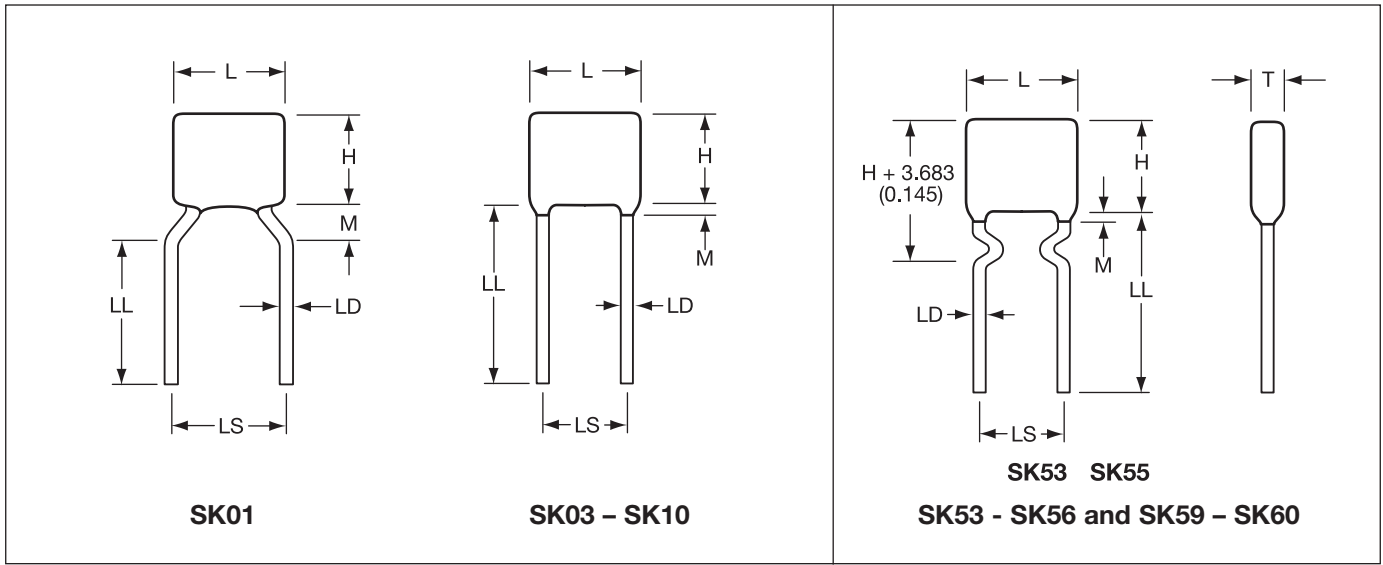

COG Capacitance Range (µF)

Style	25 WVDC min./max.	50 WVDC min./max.	100 WVDC min./max.	200 WVDC min./max.	500 WVDC min./max.
SK01	.001/0.015	.001/0.012	.001/0.010	.0010/0.0056	.0010/0.0018
SK03/SK53	.01/0.056	.01/0.047	.01/0.039	.001/0.022	.001/0.0068
SK04/SK54	.01/0.12	.01/0.10	.01/0.082	.01/0.047	.001/0.015
SK05/SK55	.01/0.18	.01/0.15	.01/0.12	.01/0.068	.001/0.022
SK06/SK56	.10/0.56	.01/0.47	.01/0.39	.01/0.22	.01/0.068
SK07	.10/0.68	.01/0.56	.01/0.47	.01/0.27	.01/0.082
SK08	.82/1.20	.68/1.10	.56/0.82	.33/0.47	.10/0.15
SK09/SK59	.10/0.27	.01/0.22	.01/0.18	.01/0.10	.001/0.039
SK10/SK60	.10/0.68	.01/0.56	.01/0.47	.01/0.27	.01/0.082

X7R Capacitance Range (µF)

Style	25 WVDC min./max.	50 WVDC min./max.	100 WVDC min./max.	200 WVDC min./max.	500 WVDC min./max.
SK01	.01/0.39	.01/0.33	.01/0.27	.01/0.12	.001/0.047
SK03/SK53	.10/2.2	.10/1.8	.01/1.5	.01/0.68	.01/0.27
SK04/SK54	.10/4.7	.10/3.3	.10/2.7	.01/1.0	.01/0.47
SK05/SK55	.10/6.8	.10/6.8	.10/3.9	.10/1.8	.01/0.68
SK06/SK56	1.0/15	1.0/10	.10/5.6	.10/3.9	.10/1.5
SK07	1.0/18	1.0/14	1.0/8.2	.10/4.7	.10/2.2
SK08	22/33	15/22	10/15	5.6/8.2	2.2/3.9
SK09/SK59	.10/8.2	.10/5.6	.10/3.3	.10/2.2	.10/1.2
SK10/SK60	1.0/18	1.0/12	.10/6.8	.10/4.7	.10/2.2

N1500 Capacitance Range (µF)

Style	50 WVDC min./max.	100 WVDC min./max.	200 WVDC min./max.	500 WVDC min./max.
SK01	.001/0.022	.001/0.018	.001/0.012	.001/0.0027
SK03/SK53	.01/0.10	.01/0.082	.01/0.056	.001/0.012
SK04/SK54	.01/0.22	.01/0.15	.01/0.12	.001/0.027
SK05/SK55	.01/0.27	.01/0.22	.01/0.18	.001/0.039
SK06/SK56	.01/0.82	.01/0.68	.01/0.47	.01/0.12
SK07	.01/1.00	.01/0.82	.01/0.56	.01/0.15
SK08	.68/2.00	.88/1.60	.62/1.20	.21/0.30
SK09/SK59	.01/0.56	.01/0.39	.01/0.27	.01/0.068
SK10/SK60	.01/1.00	.01/0.82	.01/0.68	.01/0.15

DIMENSIONS

millimeters (inches)

Style	L (max.)	H (max.)	T (max.)	LS (nom.)	LD (nom.)
SK01	5.08 (0.200)	5.08 (0.200)	5.08 (0.200)	5.08 (0.200)	0.508 (0.020)
SK03/SK53	7.62 (0.300)	7.62 (0.300)	5.08 (0.200)	5.08 (0.200)	0.508 (0.020)
SK04/SK54	10.2 (0.400)	10.2 (0.400)	5.08 (0.200)	5.08 (0.200)	0.508 (0.020)
SK05/SK55	12.7 (0.500)	12.7 (0.500)	5.08 (0.200)	10.2 (0.400)	0.635 (0.025)
SK06/SK56	22.1 (0.870)	15.2 (0.600)	5.08 (0.200)	20.1 (0.790)	0.813 (0.032)
SK07	27.9 (1.100)	15.2 (0.600)	5.08 (0.200)	24.9 (0.980)	0.813 (0.032)
SK08	27.9 (1.100)	15.2 (0.600)	8.89 (0.350)	24.9 (0.980)	0.813 (0.032)
SK09/SK59	17.0 (0.670)	13.7 (0.540)	5.08 (0.200)	14.6 (0.575)	0.635 (0.025)
SK10/SK60	23.6 (0.930)	18.3 (0.720)	6.35 (0.250)	20.3 (0.800)	0.813 (0.032)

L = Length
H = Height

T = Thickness
M = Meniscus 1.52 (0.060) max.

LS = Lead Spacing Nominal ±.787 (0.031)
LL = Lead Length 50.8 (2.000) max./25.4 (1.000) min.
LD = Lead Diameter Nominal ±.050 (0.002)

SMPS Capacitors

SE Style – Extended Commercial Radial Range

PRODUCT OFFERING – X7R

AVX SE styles offer capacitance extension to popular SK ranges. The CV product for SE-series, X7R capacitors (TCC: $\pm 15\%$ over -55 to $+125^\circ\text{C}$) compares favorably to high CV ranges offered by other suppliers in much less stable Y5U dielectric (TCC: $+22/-56\%$ over -30 to $+85^\circ\text{C}$). SE style capacitors are conformally coated and are designed for input and output filtering applications in switch mode power supplies.

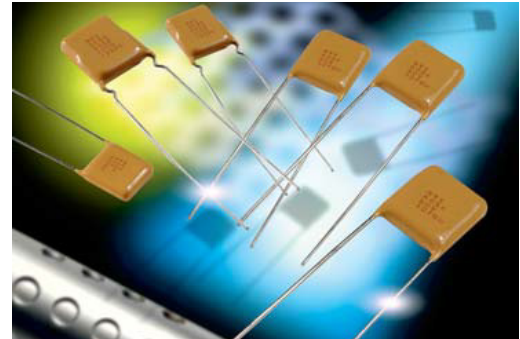

ELECTRICAL SPECIFICATIONS

Temperature Coefficient

X7R: Temperature Coefficient $\pm 15\%$, -55° to $+125^\circ\text{C}$

Capacitance Test (MIL-STD-202 Method 305)

X7R: 25°C , 1.0 ± 0.2 Vrms (open circuit voltage) at 1KHz

Dissipation Factor 25°C

X7R: 2.5% Max @ 25°C , 1.0 ± 0.2 Vrms (open circuit voltage) at 1KHz

Insulation Resistance 25°C (MIL-STD-202 Method 302)

X7R: 100K M Ω or 1000 M Ω - μF , whichever is less.

Insulation Resistance 125°C (MIL-STD-202 Method 302)

X7R: 10K M Ω or 100 M Ω - μF , whichever is less.

Dielectric Withstanding Voltage 25°C (Flash Test)

X7R: 250% rated voltage for 5 seconds with 50 mA max charging current.

Life Test (1000 hrs)

X7R: 200% rated voltage at $+125^\circ\text{C}$

Moisture Resistance (MIL-STD-202 Method 106)

X7R: Ten cycles with no voltage applied.

Thermal Shock (MIL-STD-202 Method 107, Condition A)

X7R: Immersion Cycling (MIL-STD-202 Method 104, Condition B)

Resistance To Solder Heat (MIL-STD-202, Method 210, Condition B, for 20 seconds)

HOW TO ORDER

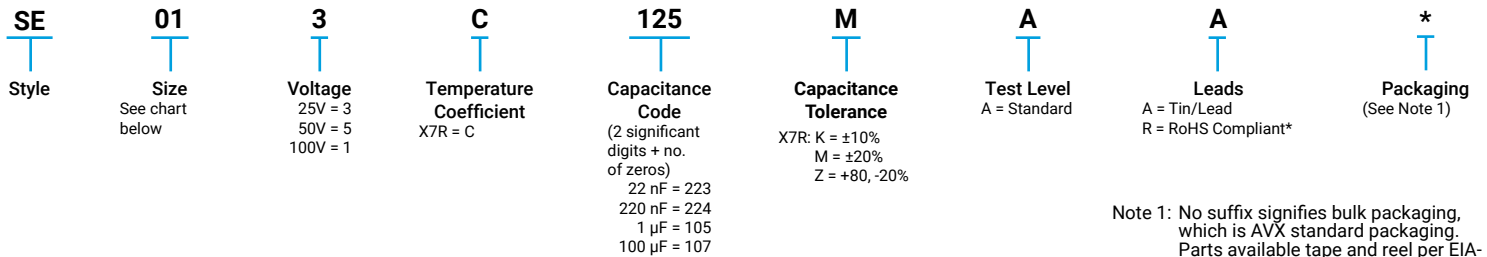

Note 1: No suffix signifies bulk packaging, which is AVX standard packaging. Parts available tape and reel per EIA-468. Use suffix "TR1" if tape & reel is required.

Note: Capacitors with X7R dielectrics are not intended for applications across AC supply mains or AC line filtering with polarity reversal. Contact plant for recommendations.

*Hi-Rel screening consists of 100% Group A, Subgroup 1 per MIL-PRF-39014.

TAPE & REEL QUANTITY	
Part	Pieces
SE01	2000
SE03/SE53	1000
SE04/SE54	1000
SE05/SE55	500
SE06/SE56	500

RoHS	
Part	Available
SE01	Yes
SE03/SE53	Yes
SE04/SE54	Yes
SE05/SE55	Yes
SE06/SE56	Yes

Not RoHS Compliant



For RoHS compliant products, please select correct termination style.

Performance of SMPS capacitors can be simulated by downloading SpiCalci software program - <http://www.avx.com/download/software/SpiCalci-AVX.zip>
Custom values, ratings and configurations are also available.

SMPS Capacitors

SE Style – Product Offering – X7R

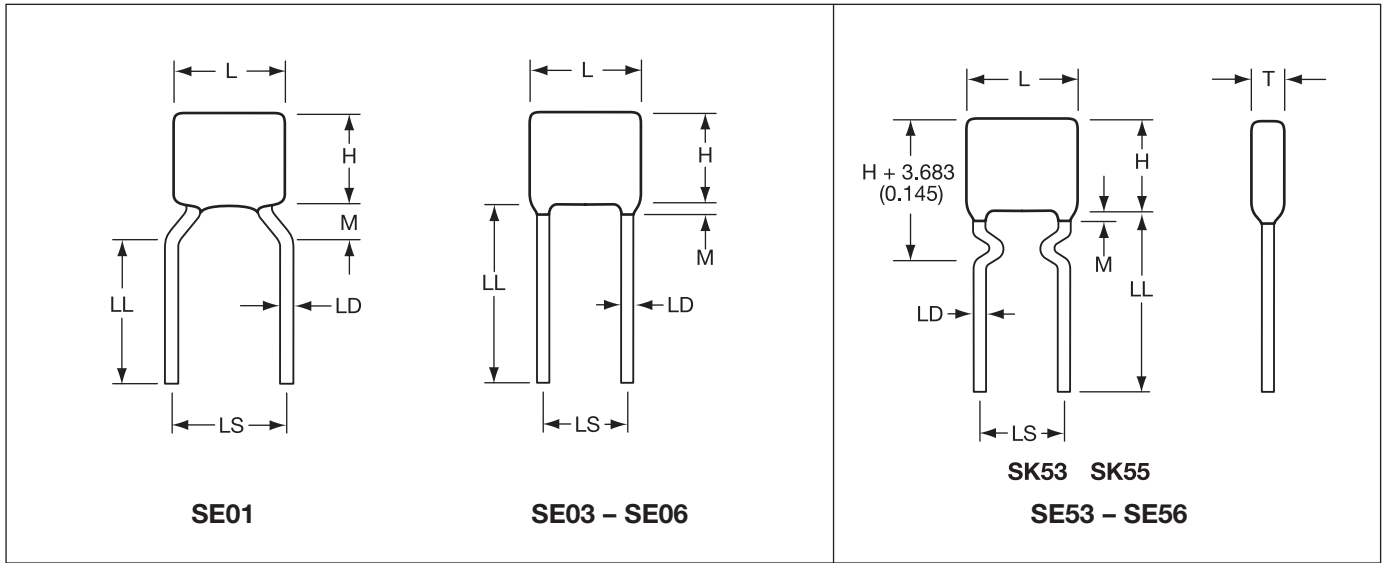

X7R Capacitance Range (µF)

Style	25 WVDC min./max.	50 WVDC min./max.	100 WVDC min./max.
SE01	0.47/1.5	0.39/1.0	0.33/0.68
SE03/SE53	2.7/6.8	2.2/4.7	1.8/3.3
SE04/SE54	5.6/12	3.9/10	3.3/6.8
SE05/SE55	8.2/18	6.8/12	4.7/10.0
SE06/SE56	18/39	12/27	6.8/15

DIMENSIONS

millimeters (inches)

Style	L (max.)	H (max.)	T (max.)	LS (nom.)	LD (nom.)
SE01	5.08 (0.200)	5.08 (0.200)	5.08 (0.200)	5.08 (0.200)	0.508 (0.020)
SE03/SE53	7.62 (0.300)	7.62 (0.300)	5.08 (0.200)	5.08 (0.200)	0.508 (0.020)
SE04/SE54	10.2 (0.400)	10.2 (0.400)	5.08 (0.200)	5.08 (0.200)	0.508 (0.020)
SE05/SE55	12.7 (0.500)	12.7 (0.500)	5.08 (0.200)	10.2 (0.400)	0.635 (0.025)
SE06/SE56	22.1 (0.870)	15.2 (0.600)	5.08 (0.200)	20.1 (0.790)	0.813 (0.032)
L = Length H = Height		T = Thickness M = Meniscus 1.52 (0.060) max.		LS = Lead Spacing Nominal ±.787 (0.031) LL = Lead Length 50.8 (2.000) max./25.4 (1.000) min. LD = Lead Diameter Nominal ±.050 (0.002)	

SMPS Capacitors

CECC Offering

Range only available in 2C1/X7R

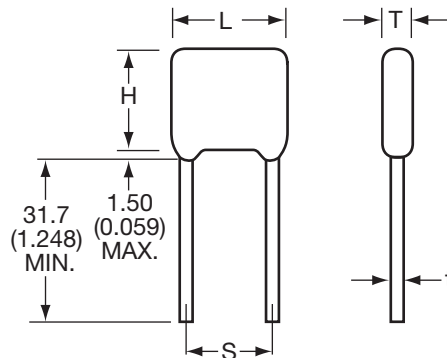

DIMENSIONS

millimeters (inches)

Size Code	Length (L) (max.)	Height (H) (max.)	Thickness (T) (max.)	Nom (t)	S ±0.4
BR40	10.16 (0.400)	11.7 (0.460)	3.81 (0.150)	0.51 (0.020)	5.08 (0.200)
BR50	12.7 (0.500)	12.7 (0.500)	5.1 (0.200)	0.64 (0.025)	10.16 (0.400)
BR84	23.6 (0.930)	17.78 (0.700)	6.35 (0.250)	0.76 (0.030)	20.32 (0.800)

CECC APPROVED RANGE

	2C1/X7R CECC 30 701 801 Issue 1			
	50V	100V	200V	500V
BR40	185-275	125-185	334-474	473-154
BR50	395-475	225-275	684-105	104-394
BR84	475-186	475-156	105-335	474-155

Not RoHS Compliant

HOW TO ORDER

BR	84	1	C	156	K	T	A
Style Code	Size Code See table below	Voltage Code 5 = 50V 1 = 100V 2 = 200V 7 = 500V	Dielectric Code C = X7R	Capacitance Code (2 significant digits + no. of zeros)	Capacitance Tolerance X7R only K = ±10% M = ±20% P = -0 +100%	Specification Code T = CECC	Lead Length Code A = 31.7mm min.

Note: If tape and reel is required, add TR to the end of the part number

High Voltage MLC Capacitors

ESCC Qualified SMPS Capacitors

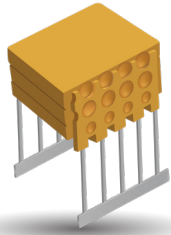

HIGH VOLTAGE CHIP CAPACITORS

Capacitors, Fixed, Chip, Ceramic Dielectric, Type II, High Voltage, Based on Styles 1812 and 1825 for use in ESCC space programs, according to ESCC Generic Specification 3009 and associated Detail Specification 3009/034 as recommended by the Space Components Coordination Group. (ranges in table below)

Note: Variants 01 to 12: metallized pads suitable for Hybrid circuits, glue or wire bonding Variants 13 to 24: finished with Sn coating suitable for soldering Variants 13 - 24 are tested "in accordance with"

HOW TO ORDER

Parts should be ordered using the ESCC variant number as follows:

3009034 **XX** **XXX**

Detail Spec Number **Type Variant (per table)** **Capacitance Code**

The first two digits represent significant figures and the third digit specifies the number of zeros to follow; i.e.
 102 = 1000pF
 103 = 10000pF

Eg 300903401223
 For LVT testing, please refer to 3009 LVT Spec

Size	Variant	Rated Voltage (kV)	Tolerance (%)	Capacitance Code (E12)
1812	01 / 13	1.0	±10	392 - 223
	02 / 14		±20	
	03 / 15	2.0	±10	152 - 182
	04 / 16		±20	
	05 / 17	3.0	±10	821 - 102
	06 / 18		±20	
1825	07 / 19	1.0	±10	273 - 563
	08 / 20		±20	
	09 / 21	2.0	±10	222 - 682
	10 / 22		±20	
	11 / 23	3.0	±10	821 - 392
	12 / 24		±20	

HIGH VOLTAGE LEADED CAPACITORS

Capacitors, Fixed, Ceramic Dielectric, Type II, High Voltage, 1.0 to 5.0 kV, Based on Case Styles VR, CV and CH for use in ESCC space programs, according to ESCC Generic Specification 3001 and associated Detail Specification 3001/034 as recommended by the Space Components Coordination Group. (ranges in table)

Note 1: Lead Types

- a - Leaded Radial (epoxy coated)
- b - Leaded Radial (Polyurethane Varnish)
- c - Straight Dual in Line
- d - L Dual in Line

Note 2: Tolerances of ±10% and ±20% are available

Note 3: AVX does not recommend or advise the use of adhesives to secure these components to the PCB or any other component / device

Case Size	Variant	Lead Type	Capacitance Code (E12)				
			1.0kV	2.0kV	3.0kV	4.0kV	5.0kV
VR30S	01	a	392 - 203	152 - 182	821 - 102		
VR30	02	a	273 - 563	222 - 682	821 - 392		
VR40	03	a	473 - 124	822 - 153	472 - 103	182 - 222	
VR50	04	a	154 - 274	183 - 333	123 - 183	562 - 822	332 - 392
VR66	05	a	224 - 564	393 - 823	223 - 393	103 - 153	682 - 103
VR84	06	a	684 - 105	473 - 154	473 - 683	183 - 393	123 - 183
VR90	07	a	125 - 275	184 - 334	823 - 184	473 - 124	223 - 563
CV41	08	b	473 - 124	822 - 153	472 - 103	182 - 222	
CH41	09	c	473 - 124	822 - 153	472 - 103	182 - 222	
CH41	10	d	473 - 124	822 - 153	472 - 103	182 - 222	
CV51	11	b	154 - 274	183 - 333	123 - 183	562 - 822	332 - 392
CH51	12	c	154 - 274	183 - 333	123 - 183	562 - 822	332 - 392
CH51	13	d	154 - 274	183 - 333	123 - 183	562 - 822	332 - 392
CV61	14	b	224 - 564	393 - 823	223 - 393	103 - 153	682 - 103
CH61	15	c	224 - 564	393 - 823	223 - 393	103 - 153	682 - 103
CH61	16	d	224 - 564	393 - 823	223 - 393	103 - 153	682 - 103
CV76	17	b	684 - 105	473 - 154	473 - 683	183 - 393	123 - 183
CH76	18	c	684 - 105	473 - 154	473 - 683	183 - 393	123 - 183
CH76	19	d	684 - 105	473 - 154	473 - 683	183 - 393	123 - 183
CV91	20	b	125 - 275	184 - 334	823 - 184	473 - 124	223 - 563
CH91	21	c	125 - 275	184 - 334	823 - 184	473 - 124	223 - 563
CH91	22	d	125 - 275	184 - 334	823 - 184	473 - 124	223 - 563

HOW TO ORDER

Parts should be ordered using the ESCC variant number as follows:

3001034 **XX** **XXX** **K** **X**

Detail Spec Number **Type Variant (per table above)** **Capacitance Code** **Capacitance Tolerance** **Voltage**

The first two digits represent significant figures and the third digit specifies the number of zeros to follow; i.e.
 102 = 1000pF
 103 = 10000pF

K = 10%
 M = 20%

M = 1kV
 P = 2kV
 R = 3kV
 S = 4kV
 Z = 5kV

Eg 300103412274M

LAT and Serialization testing can still be performed. Contact plant for further details

For LVT testing, please refer to 3001 LVT spec



High Capacitance

ESCC Qualified SMPS Capacitors

HIGH CAPACITANCE LEADED CAPACITORS

Capacitors, Fixed, Ceramic Dielectric, Type II, High Capacitance, Based on Case Styles BR, CV and CH for use in ESCC space programs, according to ESCC Generic Specification 3001 and associated Detail Specification 3001/030 as recommended by the Space Components Coordination Group. (see ranges in table below)

Note 1: Lead Types

- a - Leaded Radial (epoxy coated)
- b - Leaded Radial (Polyurethane Varnish)
- c - Straight Dual in Line
- d - L Dual in Line

Note 2: Tolerances of $\pm 10\%$ and $\pm 20\%$ are available

Case Size	Variant	Figure	Capacitance Code (E12)			
			50V	100V	200V	500V
BR40	01	a	185 - 335	125 - 395	334 - 564	124 - 224
BR50	02	a	395 - 565	225 - 395	684 - 105	274 - 394
BR66	03	a	685 - 106	475 - 825	105 - 225	474 - 105
BR72	04	a	126 - 186	825 - 156	225 - 335	824 - 155
BR84	05	a	126 - 186	825 - 156	225 - 335	824 - 155
CV41	06	b	185 - 335	125 - 275	334 - 564	124 - 224
CH41	07	c	185 - 335	125 - 275	334 - 564	124 - 224
CH41	08	d	185 - 335	125 - 275	334 - 564	124 - 224
CH42	09	c	395 - 685	335 - 565	684 - 125	274 - 474
CH42	10	d	395 - 685	335 - 565	684 - 125	274 - 474
CH43	11	c	825 - 106	685 - 825	155 - 185	564 - 684
CH43	12	d	825 - 106	685 - 825	155 - 185	564 - 684
CH44	13	c	126	106	225	824 - 105
CH44	14	d	126	106	225	824 - 105
CV51	15	b	395 - 565	225 - 395	684 - 105	274 - 394
CH51	16	c	395 - 565	225 - 395	684 - 105	274 - 394
CH51	17	d	395 - 565	225 - 395	684 - 105	274 - 394
CH52	18	c	685 - 106	475 - 825	125 - 225	474 - 824
CH52	19	d	685 - 106	475 - 825	125 - 225	474 - 824
CH53	20	c	126 - 156	106 - 126	275 - 335	105 - 125
CH53	21	d	126 - 156	106 - 126	275 - 335	105 - 125
CH54	22	c	186 - 226	156	395	155
CH54	23	d	186 - 226	156	395	155
CV61	24	b	685 - 106	475 - 825	105 - 225	474 - 105
CH61	25	c	685 - 106	475 - 825	105 - 225	474 - 105
CH61	26	d	685 - 106	475 - 825	105 - 225	474 - 105
CH62	27	c	126 - 226	106 - 156	275 - 475	105 - 185
CH62	28	d	126 - 226	106 - 156	275 - 475	105 - 185
CH63	29	c	276 - 336	186 - 226	565 - 685	225 - 275
CH63	30	d	276 - 336	186 - 226	565 - 685	225 - 275
CH64	31	c	396	276 - 336	825 - 106	335
CH64	32	d	396	276 - 336	825 - 106	335
CV71	33	b	126 - 186	825 - 156	225 - 335	824 - 155
CH71	34	c	126 - 186	825 - 156	225 - 335	824 - 155
CH71	35	d	126 - 186	825 - 156	225 - 335	824 - 155
CH72	36	c	226 - 396	186 - 276	395 - 685	185 - 335
CH72	37	d	226 - 396	186 - 276	395 - 685	185 - 335

Case Size	Variant	Figure	Capacitance Code (E12)			
			50V	100V	200V	500V
CH73	38	c	476 - 566	336 - 396	825 - 106	395 - 475
CH73	39	d	476 - 566	336 - 396	825 - 106	395 - 475
CH74	40	c	686	476	126	565
CH74	41	d	686	476	126	565
CV76	42	b	126 - 186	825 - 156	225 - 335	824 - 155
CH76	43	c	126 - 186	825 - 156	225 - 335	824 - 155
CH76	44	d	126 - 186	825 - 156	225 - 335	824 - 155
CH77	45	c	226 - 396	186 - 276	395 - 685	185 - 335
CH77	46	d	226 - 396	186 - 276	395 - 685	185 - 335
CH78	47	c	476 - 566	336 - 396	825 - 106	395 - 475
CH78	48	d	476 - 566	336 - 396	825 - 106	395 - 475
CH79	49	c	686	476	126	565
CH79	50	d	686	476	126	565
CH81	51	c	156 - 226	126 - 186	225 - 395	824 - 155
CH81	52	d	156 - 226	126 - 186	225 - 395	824 - 155
CH82	53	c	276 - 476	226 - 396	475 - 825	
CH82	54	d	276 - 476	226 - 396	475 - 825	
CH83	55	c	566 - 686	476 - 566	106 - 126	
CH83	56	d	566 - 686	476 - 566	106 - 126	
CH84	57	c	826	686	156	
CH84	58	d	826	686	156	
CH86	59	c	226 - 336	156 - 276	395 - 685	155 - 225
CH86	60	d	226 - 336	156 - 276	395 - 685	155 - 225
CH87	61	c	396 - 686	336 - 566	825 - 156	
CH87	62	d	396 - 686	336 - 566	825 - 156	
CH88	63	c	826 - 107	686 - 826	186 - 226	
CH88	64	d	826 - 107	686 - 826	186 - 226	
CH89	65	c	127	107	276	
CH89	66	d	127	107	276	
CH91	67	c	396 - 476	336 - 396	825 - 106	
CH91	68	d	396 - 476	336 - 396	825 - 106	
CH92	69	c	566 - 107	476 - 826	126 - 226	
CH92	70	d	566 - 107	476 - 826	126 - 226	
CH93	71	c	127 - 157	107 - 127	276 - 336	
CH93	72	d	127 - 157	107 - 127	276 - 336	
CH94	73	c	187	157	396	
CH94	74	d	187	157	396	

HOW TO ORDER

Parts should be ordered using the ESCC variant number as follows:

3001030

Detail Spec Number

XX

Type Variant (per table above)

XXX

Capacitance Code

The first two digits represent significant figures and the third digit specifies the number of zeros to follow; i.e.
102 = 1000pF
103 = 10000pF

K

Capacitance Tolerance
K = 10%
M = 20%

X

Voltage
C = 50V
E = 100V
G = 200V
L = 500V

EG 300103018106KC

LAT and Serialization testing can still be preformed.

Contact plant for further details

Note 3: AVX does not recommend or advise the use of adhesives to secure these components to the PCB or any other component / device

ESCC DETAIL SPECIFICATION NO. 3009/034 PHYSICAL DIMENSIONS

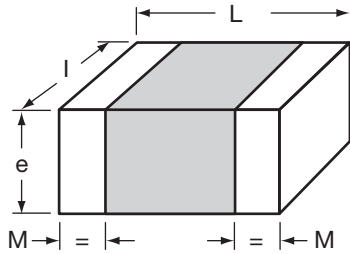

Millimeters (Inches)

Symbol	Variants 01 to 06		Variants 07 to 12	
	Min.	Max.	Min.	Max.
L	4.20 (0.165)	5.00 (0.197)	4.20 (0.165)	5.00 (0.197)
l	2.80 (0.110)	3.60 (0.142)	5.67 (0.223)	6.67 (0.263)
e	-	3.00 (0.118)	-	3.30 (0.130)
M	0.25 (0.010)	0.75 (0.030)	0.25 (0.010)	0.75 (0.030)

ESCC DETAIL SPECIFICATION NO. 3001/034 PHYSICAL DIMENSIONS – VR STYLE

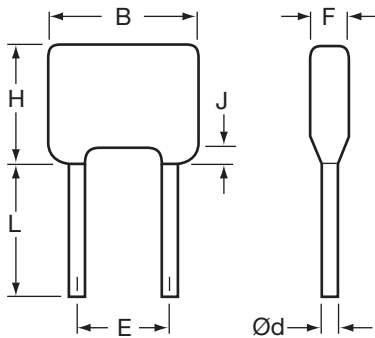

Millimeters (Inches)

Variant	Case Size	B	Ød		E		F	H	J	L
		Max.	Min.	Max.	Min.	Max.	Max.	Max.	Max.	Min.
01	VR30S	7.62 (0.300)	0.46 (0.018)	0.56 (0.022)	4.58 (0.180)	5.58 (0.220)	5.00 (0.197)	4.60 (0.181)	1.50 (0.059)	31.7 (1.248)
02	VR30	7.62 (0.300)	0.46 (0.018)	0.56 (0.022)	4.58 (0.180)	5.58 (0.220)	5.00 (0.197)	9.62 (0.379)	1.50 (0.059)	31.7 (1.248)
03	VR40	10.16 (0.400)	0.46 (0.018)	0.56 (0.022)	4.58 (0.180)	5.58 (0.220)	5.00 (0.197)	11.7 (0.461)	1.50 (0.059)	31.7 (1.248)
04	VR50	12.7 (0.500)	0.59 (0.023)	0.69 (0.027)	9.66 (0.380)	10.66 (0.420)	5.10 (0.201)	14.2 (0.559)	1.50 (0.059)	31.7 (1.248)
05	VR66	17.5 (0.689)	0.86 (0.034)	0.96 (0.038)	14.2 (0.559)	15.2 (0.598)	6.40 (0.252)	16.5 (0.650)	1.50 (0.059)	31.7 (1.248)
06	VR84	23.62 (0.930)	0.86 (0.034)	0.96 (0.038)	20.4 (0.803)	22.0 (0.866)	6.40 (0.252)	19.78 (0.779)	1.50 (0.059)	31.7 (1.248)
07	VR90	23.5 (0.925)	0.86 (0.034)	0.96 (0.038)	20.4 (0.803)	22.0 (0.866)	6.40 (0.252)	42.0 (1.654)	1.50 (0.059)	31.7 (1.248)

ESCC DETAIL SPECIFICATION NO. 3001/034 PHYSICAL DIMENSIONS – CV STYLE

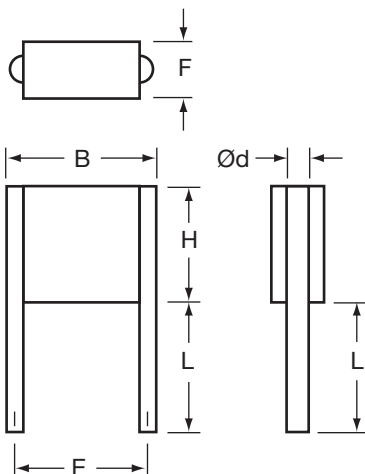

Millimeters (Inches)

Variant	Case Size	B	Ød		E		F	H	L	
		Max.	Min.	Max.	Min.	Max.	Max.	Max.	Max.	Min.
08	CV41	10.6 (0.417)	0.65 (0.026)	0.75 (0.030)	7.70 (0.303)	8.70 (0.343)	3.80 (0.150)	8.70 (0.343)	22.0 (0.866)	28.0 (1.102)
11	CV51	11.9 (0.469)	0.85 (0.033)	0.95 (0.037)	9.66 (0.380)	10.66 (0.420)	3.80 (0.150)	10.7 (0.421)	22.0 (0.866)	28.0 (1.102)
14	CV61	16.5 (0.650)	0.85 (0.033)	0.95 (0.037)	14.74 (0.580)	15.74 (0.620)	3.80 (0.150)	13.6 (0.535)	22.0 (0.866)	28.0 (1.102)
17	CV76	22.7 (0.894)	0.85 (0.033)	0.95 (0.037)	20.4 (0.803)	22.0 (0.866)	3.80 (0.150)	16.6 (0.654)	22.0 (0.866)	28.0 (1.102)
20	CV91	22.7 (0.894)	1.15 (0.045)	1.25 (0.049)	20.4 (0.803)	22.0 (0.866)	3.80 (0.150)	40.6 (1.598)	22.0 (0.866)	28.0 (1.102)

ESCC DETAIL SPECIFICATION NO. 3001/034 PHYSICAL DIMENSIONS – CH STYLE, D.I.L.

Millimeters (Inches)

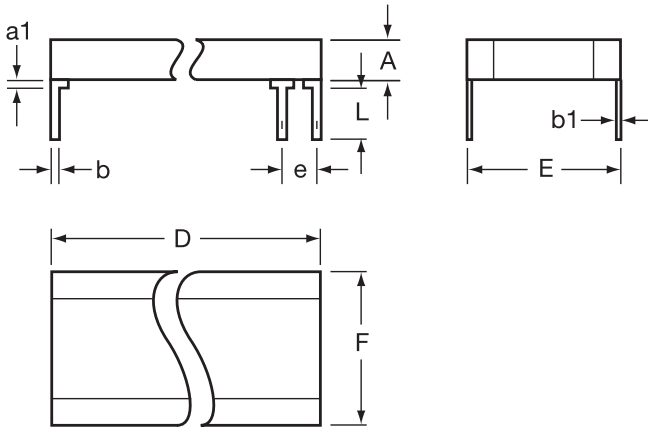

Symbol	Min.	Max.	Notes
a1	-	2.00 (0.079)	1
b	0.45 (0.018)	0.55 (0.022)	1
b1	0.204 (0.008)	0.304 (0.012)	1
e	2.49 (0.098)	2.59 (0.102)	2
L	12.0 (0.472)	14.0 (0.551)	1

Notes: 1 - All leads
2 - Each space

Variant	Case Size	A	D	E		F
		Max.	Max.	Min.	Max.	Max.
07	CH41	3.80 (0.150)	8.70 (0.343)	7.70 (0.303)	8.70 (0.343)	9.20 (0.362)
09	CH42	7.40 (0.291)	8.70 (0.343)	7.70 (0.303)	8.70 (0.343)	9.20 (0.362)
11	CH43	11.1 (0.437)	8.70 (0.343)	7.70 (0.303)	8.70 (0.343)	9.20 (0.362)
13	CH44	14.8 (0.583)	8.70 (0.343)	7.70 (0.303)	8.70 (0.343)	9.20 (0.362)
16	CH51	3.80 (0.150)	10.7 (0.421)	9.66 (0.380)	10.66 (0.420)	10.7 (0.421)
18	CH52	7.40 (0.291)	10.7 (0.421)	9.66 (0.380)	10.66 (0.420)	10.7 (0.421)
20	CH53	11.1 (0.437)	10.7 (0.421)	9.66 (0.380)	10.66 (0.420)	10.7 (0.421)
22	CH54	14.8 (0.583)	10.7 (0.421)	9.66 (0.380)	10.66 (0.420)	10.7 (0.421)
25	CH61	3.80 (0.150)	13.6 (0.535)	13.5 (0.531)	14.5 (0.571)	14.9 (0.587)
27	CH62	7.40 (0.291)	13.6 (0.535)	13.5 (0.531)	14.5 (0.571)	14.9 (0.587)
29	CH63	11.1 (0.437)	13.6 (0.535)	13.5 (0.531)	14.5 (0.571)	14.9 (0.587)
31	CH64	14.8 (0.583)	13.6 (0.535)	13.5 (0.531)	14.5 (0.571)	14.9 (0.587)
34	CH71	3.80 (0.150)	21.6 (0.850)	14.74 (0.580)	15.74 (0.620)	16.8 (0.661)
36	CH72	7.40 (0.291)	21.6 (0.850)	14.74 (0.580)	15.74 (0.620)	16.8 (0.661)
38	CH73	11.1 (0.437)	21.6 (0.850)	14.74 (0.580)	15.74 (0.620)	16.8 (0.661)
40	CH74	14.8 (0.583)	21.6 (0.850)	14.74 (0.580)	15.74 (0.620)	16.8 (0.661)
43	CH76	3.80 (0.150)	16.6 (0.654)	19.52 (0.769)	21.12 (0.831)	21.6 (0.850)
45	CH77	7.40 (0.291)	16.6 (0.654)	19.52 (0.769)	21.12 (0.831)	21.6 (0.850)
47	CH78	11.1 (0.437)	16.6 (0.654)	19.52 (0.769)	21.12 (0.831)	21.6 (0.850)
49	CH79	14.8 (0.583)	16.6 (0.654)	19.52 (0.769)	21.12 (0.831)	21.6 (0.850)
51	CH81	3.80 (0.150)	38.2 (1.504)	9.66 (0.380)	10.66 (0.420)	12.0 (0.472)
53	CH82	7.40 (0.291)	38.2 (1.504)	9.66 (0.380)	10.66 (0.420)	12.0 (0.472)
55	CH83	11.1 (0.437)	38.2 (1.504)	9.66 (0.380)	10.66 (0.420)	12.0 (0.472)
57	CH84	14.8 (0.583)	38.2 (1.504)	9.66 (0.380)	10.66 (0.420)	12.0 (0.472)
59	CH86	3.80 (0.150)	38.2 (1.504)	14.74 (0.580)	15.74 (0.620)	18.9 (0.744)
61	CH87	7.40 (0.291)	38.2 (1.504)	14.74 (0.580)	15.74 (0.620)	18.9 (0.744)
63	CH88	11.1 (0.437)	38.2 (1.504)	14.74 (0.580)	15.74 (0.620)	18.9 (0.744)
65	CH89	14.8 (0.583)	38.2 (1.504)	14.74 (0.580)	15.74 (0.620)	18.9 (0.744)
67	CH91	3.80 (0.150)	40.6 (1.598)	19.52 (0.769)	21.12 (0.831)	24.0 (0.945)
69	CH92	7.40 (0.291)	40.6 (1.598)	19.52 (0.769)	21.12 (0.831)	24.0 (0.945)
71	CH93	11.1 (0.437)	40.6 (1.598)	19.52 (0.769)	21.12 (0.831)	24.0 (0.945)
73	CH94	14.8 (0.583)	40.6 (1.598)	19.52 (0.769)	21.12 (0.831)	24.0 (0.945)

ESCC DETAIL SPECIFICATION NO. 3001/034 PHYSICAL DIMENSIONS – CH STYLE, L

Millimeters (Inches)

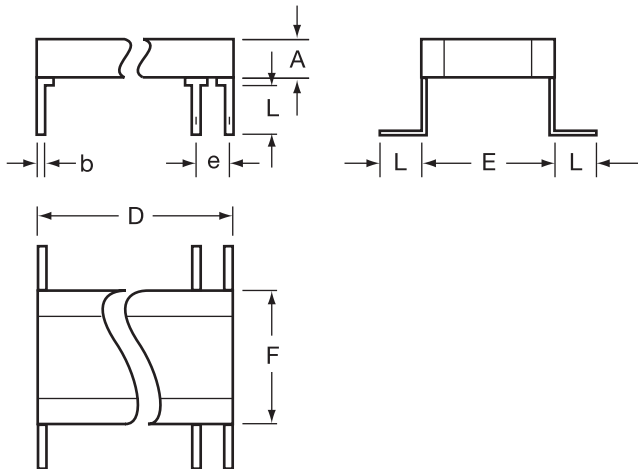

Variant	Case Size	A	D	E		F
		Max.	Max.	Min.	Max.	Max.
10	CH41	3.80 (0.150)	8.70 (0.343)	7.70 (0.303)	8.70 (0.343)	9.20 (0.362)
13	CH51	3.80 (0.150)	10.7 (0.421)	9.66 (0.380)	10.66 (0.420)	10.7 (0.421)
16	CH61	3.80 (0.150)	13.6 (0.535)	13.5 (0.531)	14.5 (0.571)	14.9 (0.587)
19	CH76	3.80 (0.150)	16.6 (0.654)	19.52 (0.769)	21.12 (0.831)	21.6 (0.850)
22	CH91	3.80 (0.150)	40.6 (1.598)	19.52 (0.769)	21.12 (0.831)	24.0 (0.945)

Symbol	Min.	Max.	Notes
b	0.45 (0.018)	0.55 (0.022)	1
e	2.49 (0.098)	2.59 (0.102)	2
L	2.04 (0.080)	3.01 (0.120)	1

Notes: 1 - All leads
2 - Each space

ESCC DETAIL SPECIFICATION NO. 3001/030 PHYSICAL DIMENSIONS – BR STYLE

Millimeters (Inches)

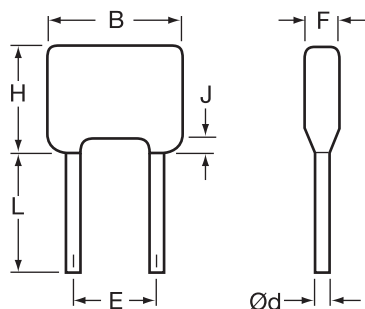

Variant	Case Size	B		Ød		E		F	H	J	L
		Max.	Min.	Max.	Min.	Max.	Max.	Max.	Max.	Max.	Min.
01	BR40	10.16 (0.400)	0.46 (0.018)	0.56 (0.022)	4.58 (0.180)	5.58 (0.220)	5.00 (0.197)	11.7 (0.461)	1.50 (0.059)	31.7 (1.248)	
02	BR50	12.7 (0.500)	0.59 (0.023)	0.69 (0.027)	9.66 (0.380)	10.66 (0.420)	5.10 (0.201)	14.2 (0.559)	1.50 (0.059)	31.7 (1.248)	
03	BR66	17.5 (0.689)	0.86 (0.034)	0.96 (0.038)	14.2 (0.559)	15.2 (0.598)	6.40 (0.252)	16.5 (0.650)	1.50 (0.059)	31.7 (1.248)	
04	BR72	19.3 (0.760)	0.86 (0.034)	0.96 (0.038)	14.74 (0.580)	15.74 (0.620)	6.40 (0.252)	24.0 (0.945)	1.50 (0.059)	31.7 (1.248)	
05	BR84	23.62 (0.930)	0.71 (0.028)	0.81 (0.032)	18.93 (0.745)	20.83 (0.820)	6.40 (0.252)	19.78 (0.779)	1.50 (0.059)	31.7 (1.248)	

ESCC DETAIL SPECIFICATION NO. 3001/030 PHYSICAL DIMENSIONS – CV STYLE

Millimeters (Inches)

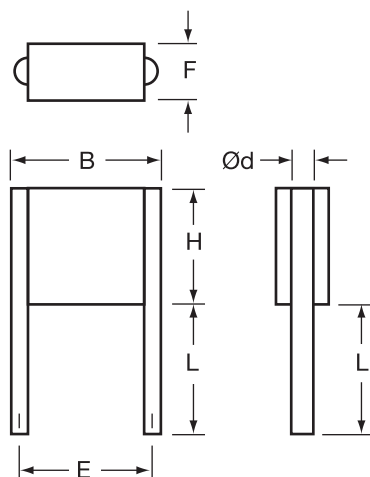

Variant	Case Size	B		Ød		E		F	H	L	
		Max.	Min.	Max.	Min.	Max.	Max.	Max.	Max.	Min.	
06	CV41	10.6 (0.417)	0.65 (0.026)	0.75 (0.030)	7.70 (0.303)	8.70 (0.343)	3.80 (0.150)	8.70 (0.343)	22.0 (0.866)	28.0 (1.102)	
15	CV51	11.9 (0.469)	0.85 (0.033)	0.95 (0.037)	9.66 (0.380)	10.66 (0.420)	3.80 (0.150)	10.7 (0.421)	22.0 (0.866)	28.0 (1.102)	
24	CV61	16.5 (0.650)	0.85 (0.033)	0.95 (0.037)	14.74 (0.580)	15.74 (0.620)	3.80 (0.150)	13.6 (0.535)	22.0 (0.866)	28.0 (1.102)	
33	CV71	17.8 (0.701)	0.85 (0.033)	0.95 (0.037)	14.74 (0.580)	15.74 (0.620)	3.80 (0.150)	21.6 (0.850)	22.0 (0.866)	28.0 (1.102)	
42	CV76	22.7 (0.894)	0.85 (0.033)	0.95 (0.037)	20.4 (0.803)	22.0 (0.866)	3.80 (0.150)	16.6 (0.654)	22.0 (0.866)	28.0 (1.102)	

ESCC DETAIL SPECIFICATION NO. 3001/030 PHYSICAL DIMENSIONS – CH STYLE, D.I.L.

Millimeters (Inches)

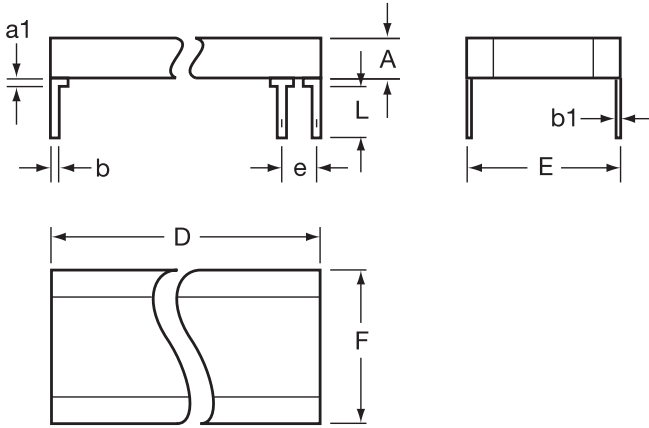

Symbol	Min.	Max.	Notes
a1	-	2.00 (0.079)	1
b	0.45 (0.018)	0.55 (0.022)	1
b1	0.204 (0.008)	0.304 (0.012)	1
e	2.49 (0.098)	2.59 (0.102)	2
L	2.04 (0.080)	3.04 (0.120)	1

Notes: 1 - All leads
2 - Each space

Variant	Case Size	A		D		E		F
		Max.	Max.	Min.	Max.	Max.		
07	CH41	3.80 (0.150)	8.70 (0.343)	7.70 (0.303)	8.70 (0.343)	9.20 (0.362)		
09	CH42	7.40 (0.291)	8.70 (0.343)	7.70 (0.303)	8.70 (0.343)	9.20 (0.362)		
11	CH43	11.1 (0.437)	8.70 (0.343)	7.70 (0.303)	8.70 (0.343)	9.20 (0.362)		
13	CH44	14.8 (0.583)	8.70 (0.343)	7.70 (0.303)	8.70 (0.343)	9.20 (0.362)		
16	CH51	3.80 (0.150)	10.7 (0.421)	9.66 (0.380)	10.66 (0.420)	10.7 (0.421)		
18	CH52	7.40 (0.291)	10.7 (0.421)	9.66 (0.380)	10.66 (0.420)	10.7 (0.421)		
20	CH53	11.1 (0.437)	10.7 (0.421)	9.66 (0.380)	10.66 (0.420)	10.7 (0.421)		
22	CH54	14.8 (0.583)	10.7 (0.421)	9.66 (0.380)	10.66 (0.420)	10.7 (0.421)		
25	CH61	3.80 (0.150)	13.6 (0.535)	13.5 (0.531)	14.5 (0.571)	14.9 (0.587)		
27	CH62	7.40 (0.291)	13.6 (0.535)	13.5 (0.531)	14.5 (0.571)	14.9 (0.587)		
29	CH63	11.1 (0.437)	13.6 (0.535)	13.5 (0.531)	14.5 (0.571)	14.9 (0.587)		
31	CH64	14.8 (0.583)	13.6 (0.535)	13.5 (0.531)	14.5 (0.571)	14.9 (0.587)		
34	CH71	3.80 (0.150)	21.6 (0.850)	14.74 (0.580)	15.74 (0.620)	16.8 (0.661)		
36	CH72	7.40 (0.291)	21.6 (0.850)	14.74 (0.580)	15.74 (0.620)	16.8 (0.661)		
38	CH73	11.1 (0.437)	21.6 (0.850)	14.74 (0.580)	15.74 (0.620)	16.8 (0.661)		
40	CH74	14.8 (0.583)	21.6 (0.850)	14.74 (0.580)	15.74 (0.620)	16.8 (0.661)		
43	CH76	3.80 (0.150)	16.6 (0.654)	19.52 (0.769)	21.12 (0.831)	21.6 (0.850)		
45	CH77	7.40 (0.291)	16.6 (0.654)	19.52 (0.769)	21.12 (0.831)	21.6 (0.850)		
47	CH78	11.1 (0.437)	16.6 (0.654)	19.52 (0.769)	21.12 (0.831)	21.6 (0.850)		
49	CH79	14.8 (0.583)	16.6 (0.654)	19.52 (0.769)	21.12 (0.831)	21.6 (0.850)		
51	CH81	3.80 (0.150)	38.2 (1.504)	9.66 (0.380)	10.66 (0.420)	12.0 (0.472)		
53	CH82	7.40 (0.291)	38.2 (1.504)	9.66 (0.380)	10.66 (0.420)	12.0 (0.472)		
55	CH83	11.1 (0.437)	38.2 (1.504)	9.66 (0.380)	10.66 (0.420)	12.0 (0.472)		
57	CH84	14.8 (0.583)	38.2 (1.504)	9.66 (0.380)	10.66 (0.420)	12.0 (0.472)		
59	CH86	3.80 (0.150)	38.2 (1.504)	14.74 (0.580)	15.74 (0.620)	18.9 (0.744)		
61	CH87	7.40 (0.291)	38.2 (1.504)	14.74 (0.580)	15.74 (0.620)	18.9 (0.744)		
63	CH88	11.1 (0.437)	38.2 (1.504)	14.74 (0.580)	15.74 (0.620)	18.9 (0.744)		
65	CH89	14.8 (0.583)	38.2 (1.504)	14.74 (0.580)	15.74 (0.620)	18.9 (0.744)		
67	CH91	3.80 (0.150)	40.6 (1.598)	19.52 (0.769)	21.12 (0.831)	24.0 (0.945)		
69	CH92	7.40 (0.291)	40.6 (1.598)	19.52 (0.769)	21.12 (0.831)	24.0 (0.945)		
71	CH93	11.1 (0.437)	40.6 (1.598)	19.52 (0.769)	21.12 (0.831)	24.0 (0.945)		
73	CH94	14.8 (0.583)	40.6 (1.598)	19.52 (0.769)	21.12 (0.831)	24.0 (0.945)		

ESCC DETAIL SPECIFICATION NO. 3001/030 PHYSICAL DIMENSIONS – CH STYLE, L

Millimeters (Inches)

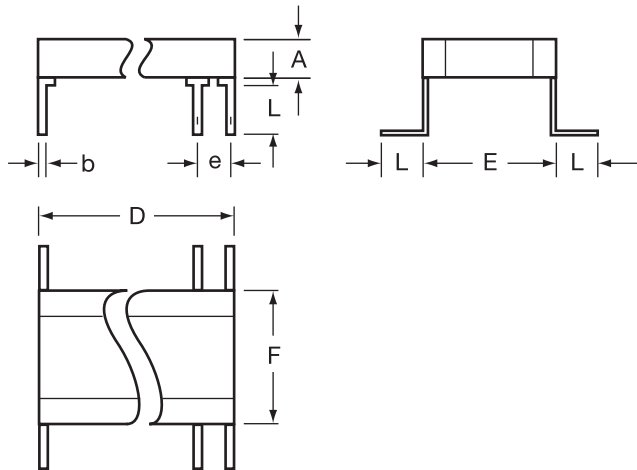

Symbol	Min.	Max.	Notes
b	0.45 (0.018)	0.55 (0.022)	1
e	2.49 (0.098)	2.59 (0.102)	2
L	2.04 (0.080)	3.04 (0.120)	1

Notes: 1 - All leads
2 - Each space

Variant	Case Size	A		D		E		F
		Max.	Max.	Min.	Max.	Max.		
08	CH41	3.80 (0.150)	8.70 (0.343)	7.70 (0.303)	8.70 (0.343)	9.20 (0.362)		
10	CH42	7.40 (0.291)	8.70 (0.343)	7.70 (0.303)	8.70 (0.343)	9.20 (0.362)		
12	CH43	11.1 (0.437)	8.70 (0.343)	7.70 (0.303)	8.70 (0.343)	9.20 (0.362)		
14	CH44	14.8 (0.583)	8.70 (0.343)	7.70 (0.303)	8.70 (0.343)	9.20 (0.362)		
17	CH51	3.80 (0.150)	10.7 (0.421)	9.66 (0.380)	10.66 (0.420)	10.7 (0.421)		
19	CH52	7.40 (0.291)	10.7 (0.421)	9.66 (0.380)	10.66 (0.420)	10.7 (0.421)		
21	CH53	11.1 (0.437)	10.7 (0.421)	9.66 (0.380)	10.66 (0.420)	10.7 (0.421)		
23	CH54	14.8 (0.583)	10.7 (0.421)	9.66 (0.380)	10.66 (0.420)	10.7 (0.421)		
26	CH61	3.80 (0.150)	13.6 (0.535)	13.5 (0.531)	14.5 (0.571)	14.9 (0.587)		
28	CH62	7.40 (0.291)	13.6 (0.535)	13.5 (0.531)	14.5 (0.571)	14.9 (0.587)		
30	CH63	11.1 (0.437)	13.6 (0.535)	13.5 (0.531)	14.5 (0.571)	14.9 (0.587)		
32	CH64	14.8 (0.583)	13.6 (0.535)	13.5 (0.531)	14.5 (0.571)	14.9 (0.587)		
35	CH71	3.80 (0.150)	21.6 (0.850)	14.74 (0.580)	15.74 (0.620)	16.8 (0.661)		
37	CH72	7.40 (0.291)	21.6 (0.850)	14.74 (0.580)	15.74 (0.620)	16.8 (0.661)		
39	CH73	11.1 (0.437)	21.6 (0.850)	14.74 (0.580)	15.74 (0.620)	16.8 (0.661)		
41	CH74	14.8 (0.583)	21.6 (0.850)	14.74 (0.580)	15.74 (0.620)	16.8 (0.661)		
44	CH76	3.80 (0.150)	16.6 (0.654)	19.52 (0.769)	21.12 (0.831)	21.6 (0.850)		
46	CH77	7.40 (0.291)	16.6 (0.654)	19.52 (0.769)	21.12 (0.831)	21.6 (0.850)		
48	CH78	11.1 (0.437)	16.6 (0.654)	19.52 (0.769)	21.12 (0.831)	21.6 (0.850)		
50	CH79	14.8 (0.583)	16.6 (0.654)	19.52 (0.769)	21.12 (0.831)	21.6 (0.850)		
52	CH81	3.80 (0.150)	38.2 (1.504)	9.66 (0.380)	10.66 (0.420)	12.0 (0.472)		
54	CH82	7.40 (0.291)	38.2 (1.504)	9.66 (0.380)	10.66 (0.420)	12.0 (0.472)		
56	CH83	11.1 (0.437)	38.2 (1.504)	9.66 (0.380)	10.66 (0.420)	12.0 (0.472)		
58	CH84	14.8 (0.583)	38.2 (1.504)	9.66 (0.380)	10.66 (0.420)	12.0 (0.472)		
60	CH86	3.80 (0.150)	38.2 (1.504)	14.74 (0.580)	15.74 (0.620)	18.9 (0.744)		
62	CH87	7.40 (0.291)	38.2 (1.504)	14.74 (0.580)	15.74 (0.620)	18.9 (0.744)		
64	CH88	11.1 (0.437)	38.2 (1.504)	14.74 (0.580)	15.74 (0.620)	18.9 (0.744)		
66	CH89	14.8 (0.583)	38.2 (1.504)	14.74 (0.580)	15.74 (0.620)	18.9 (0.744)		
68	CH91	3.80 (0.150)	40.6 (1.598)	19.52 (0.769)	21.12 (0.831)	24.0 (0.945)		
70	CH92	7.40 (0.291)	40.6 (1.598)	19.52 (0.769)	21.12 (0.831)	24.0 (0.945)		
72	CH93	11.1 (0.437)	40.6 (1.598)	19.52 (0.769)	21.12 (0.831)	24.0 (0.945)		
74	CH94	14.8 (0.583)	40.6 (1.598)	19.52 (0.769)	21.12 (0.831)	24.0 (0.945)		

COG Dielectric General Specifications

Capacitance Range
 100 pF to 1.2 μ F
 (25°C, 1.0 \pm 0.2 Vrms (open circuit voltage)
 at 1 KHz, for \leq 100 pF use 1 MHz)

Capacitance Tolerances
 \pm 5%, \pm 10%, \pm 20%

Operating Temperature Range
 -55°C to +125°C

Temperature Characteristic
 0 \pm 30 ppm/°C

Voltage Ratings
 1000 VDC thru 5000 VDC (+125°C)

Dissipation Factor
 0.15% max.
 (25°C, 1.0 \pm 0.2 Vrms (open circuit voltage)
 at 1 KHz, for \leq 100 pF use 1 MHz)

Insulation Resistance (+25°C, at 500V)
 100K M Ω min., or 1000 M Ω - μ F min.,
 whichever is less

Insulation Resistance (+125°C, at 500V)
 10K M Ω min., or 100 M Ω - μ F min.,
 whichever is less

Dielectric Strength
 120% rated voltage, 5 seconds

Life Test
 100% rated and +125°C

N1500 General Specifications

Capacitance Range
 100 pF to 1.9 μ F
 (25°C, 1.0 \pm 0.2 Vrms (open circuit voltage)
 at 1 KHz)

Capacitance Tolerances
 \pm 5%, \pm 10%, \pm 20%

Operating Temperature Range
 -55°C to +125°C

Temperature Characteristic
 -1500 \pm 250 ppm/°C

Voltage Ratings
 1000 VDC thru 5000 VDC (+125°C)

Dissipation Factor
 0.15% max.
 (25°C, 1.0 \pm 0.2 Vrms (open circuit voltage)
 at 1 KHz)

Insulation Resistance (+25°C, at 500V)
 100K M Ω min., or 1000 M Ω - μ F min.,
 whichever is less

Insulation Resistance (+125°C, at 500V)
 10K M Ω min., or 100 M Ω - μ F min.,
 whichever is less

Dielectric Strength
 120% rated voltage, 5 seconds

Life Test
 100% rated and +125°C

X7R Dielectric General Specifications

Capacitance Range
 100 pF to 15 μ F
 (25°C, 1.0 \pm 0.2 Vrms (open circuit voltage)
 at 1 KHz)

Capacitance Tolerances
 \pm 10%, \pm 20%, +80%, -20%

Operating Temperature Range
 -55°C to +125°C

Temperature Characteristic
 \pm 15% (0 VDC)

Voltage Ratings
 1000 VDC thru 5000 VDC (+125°C)

Dissipation Factor
 2.5% max.
 (25°C, 1.0 \pm 0.2 Vrms (open circuit voltage) at
 1 KHz)

Insulation Resistance (+25°C, at 500V)
 100K M Ω min., or 1000 M Ω - μ F min.,
 whichever is less

Insulation Resistance (+125°C, at 500V)
 10K M Ω min., or 100 M Ω - μ F min.,
 whichever is less

Dielectric Strength
 120% rated voltage, 5 seconds

Life Test
 100% rated and +125°C

HOW TO ORDER

HV	01	A	C	105	M	A	N	650
AVX Style	Size See Dimensions chart	Voltage 1K = A 2K = G 3K = H 4K = J 5K = K	Temperature Coefficient COG = A X7R = C N1500 = 4	Capacitance Code (2 significant digits + number of zeros) 10 pF = 100 100 pF = 101 1,000 pF = 102 22,000 pF = 223 220,000 pF = 224 1 μ F = 105 10 μ F = 106 100 μ F = 107	Capacitance Tolerance COG: J = \pm 5% K = \pm 10% M = \pm 20% X7R: K = \pm 10% M = \pm 20% Z = +80%, -20% N1500: J = \pm 5% K = \pm 10% M = \pm 20%	Test Level A = Does not apply	Termination N = Straight Lead J = Leads formed in L = Leads formed out P = P Style Leads Z = Z Style Leads	Height Max Dimension "A" 120 = 0.120" 240 = 0.240" 360 = 0.360" 480 = 0.480" 650 = 0.650"

Note: Capacitors with X7R dielectrics are not intended for applications across AC supply mains or AC line filtering with polarity reversal. Contact plant for recommendations.

Not RoHS Compliant

Performance of SMPS capacitors can be simulated by downloading SpiCalci software program -
<http://www.avx.com/download/software/SpiCalci-AVX.zip>
 Custom values, ratings and configurations are also available.

High Voltage MLC Ledged

HV Styles (US Preferred Sizes) DIP Lead

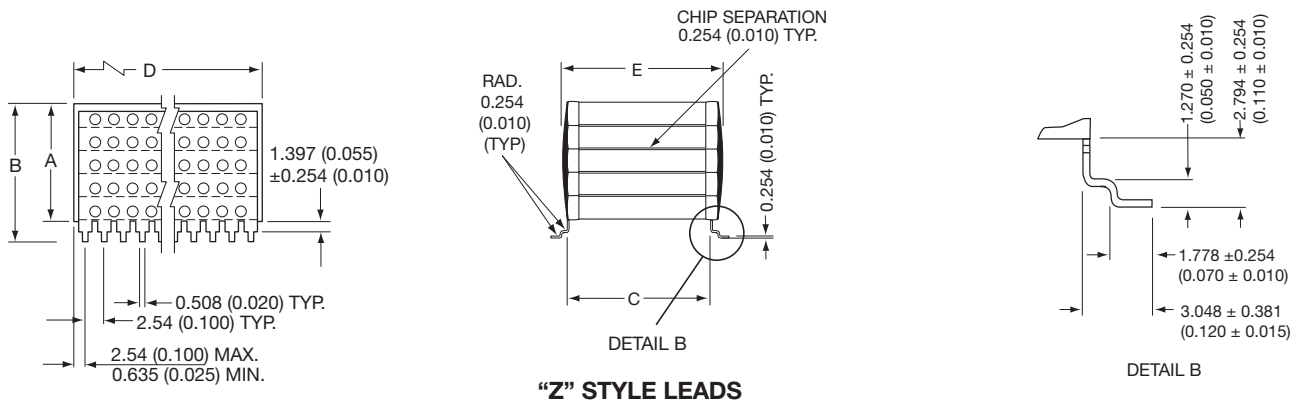
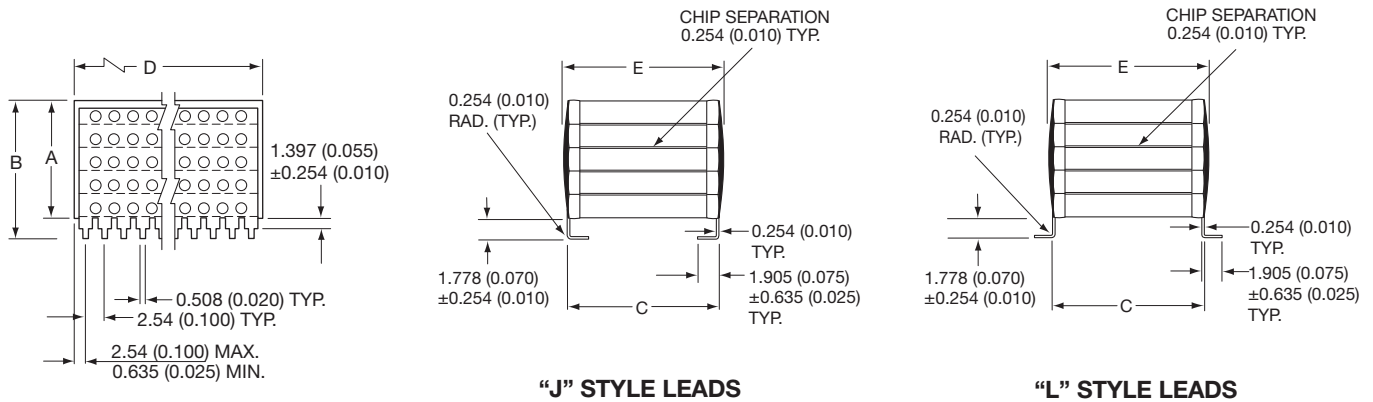
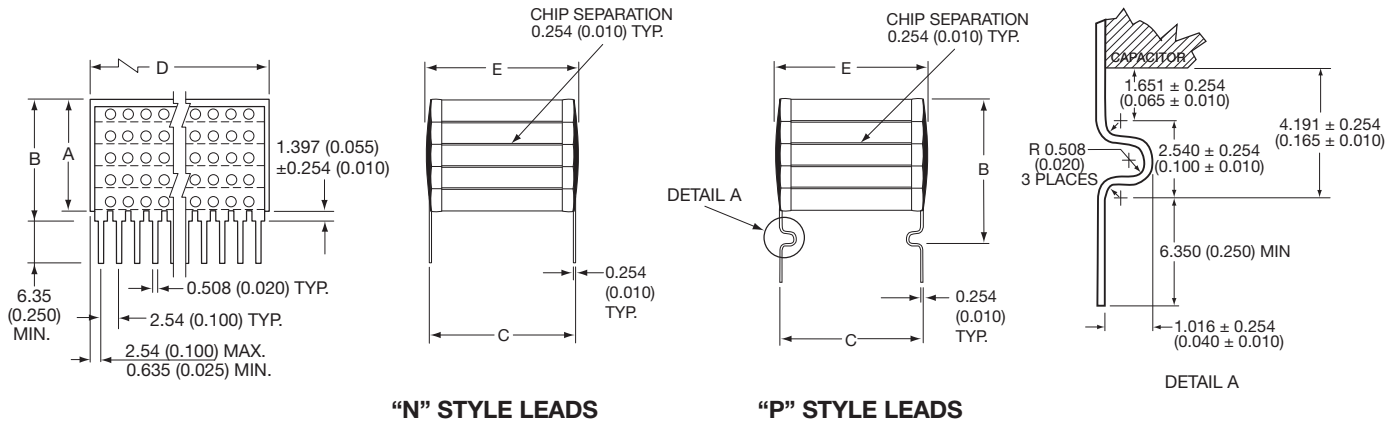

DIMENSIONS

millimeters (inches)

Style	A (max.)	B (max.)	C ± 0.635 (±0.025)	D ± 0.635 (±0.025)	E (max.)	No. of Leads per side
HV01	See page 83 for maximum "A" Dimension	For "N" Style Leads: "A" Dimension Plus 1.651 (0.065) For "J" & "L" Style Leads: "A" Dimension Plus 2.032 (0.080) For "P" Style Leads: "A" Dimension Plus 4.445 (0.175) For "Z" Style Leads: "A" Dimension Plus 3.048 (0.120)	53.3 (2.100)	10.5 (0.415)	54.9 (2.160)	4
HV02			39.1 (1.540)	20.3 (0.800)	40.7 (1.600)	8
HV03			27.2 (1.070)	10.5 (0.415)	28.2 (1.130)	4
HV04			10.2 (0.400)	10.2 (0.400)	11.2 (0.440)	4
HV05			6.35 (0.250)	6.35 (0.250)	7.62 (0.300)	3
HV06			53.3 (2.100)	29.0 (1.140)	54.9 (2.160)	11

High Voltage MLC Leaded

HV Styles (US Preferred Sizes) DIP Lead



Max Capacitance (µF) Available Versus Style with Height (A) of 0.120" - 3.05mm

AVX STYLE	HV01 _____ AN120					HV02 _____ AN120					HV03 _____ AN120					HV04 _____ AN120					HV05 _____ AN120		HV06 _____ AN120				
	1KV	2KV	3KV	4KV	5KV	1KV	2KV	3KV	4KV	5KV	1KV	2KV	3KV	4KV	5KV	1KV	2KV	3KV	4KV	5KV	1KV	2KV	1KV	2KV	3KV	4KV	5KV
C0G	.086	.024	.011	.0062	.0052	.120	.034	.015	.0088	.0074	.042	.013	.0058	.0030	.0024	.012	.0040	.0018	.0009	.0007	.0048	.0013	.240	.066	.028	.018	.015
N1500	.140	.042	.018	.010	.0084	.200	.058	.024	.014	.012	.068	.020	.0090	.0050	.0040	.020	.0066	.0028	.0014	.0012	.0078	.0022	.380	.100	.046	.030	.026
X7R	1.10	.260	.150	.066	.052	1.50	.360	.200	.094	.078	.520	.130	.072	.032	.024	.160	.042	---	---	---	.060	---	3.00	.700	.440	.200	.170

Max Capacitance (µF) Available Versus Style with Height (A) of 0.240" - 6.10mm

AVX STYLE	HV01 _____ AN240					HV02 _____ AN240					HV03 _____ AN240					HV04 _____ AN240					HV05 _____ AN240		HV06 _____ AN240				
	1KV	2KV	3KV	4KV	5KV	1KV	2KV	3KV	4KV	5KV	1KV	2KV	3KV	4KV	5KV	1KV	2KV	3KV	4KV	5KV	1KV	2KV	1KV	2KV	3KV	4KV	5KV
C0G	.170	.048	.022	.012	.010	.240	.068	.031	.017	.015	.084	.026	.011	.0060	.0048	.025	.0082	.0036	.0018	.0014	.0096	.0027	.480	.130	.056	.036	.031
N1500	.280	.084	.036	.020	.016	.400	.110	.048	.028	.024	.130	.040	.018	.010	.0080	.040	.013	.0056	.0028	.0025	.015	.0044	.760	.210	.092	.060	.052
X7R	2.20	.520	.300	.130	.100	3.10	.720	.400	.180	.150	1.00	.270	.140	.064	.048	.330	.084	---	---	---	.120	---	6.00	1.40	.880	.400	.340

Max Capacitance (µF) Available Versus Style with Height (A) of 0.360" - 9.15mm

AVX STYLE	HV01 _____ AN360					HV02 _____ AN360					HV03 _____ AN360					HV04 _____ AN360					HV05 _____ AN360		HV06 _____ AN360				
	1KV	2KV	3KV	4KV	5KV	1KV	2KV	3KV	4KV	5KV	1KV	2KV	3KV	4KV	5KV	1KV	2KV	3KV	4KV	5KV	1KV	2KV	1KV	2KV	3KV	4KV	5KV
C0G	.250	.072	.033	.018	.015	.360	.100	.047	.026	.022	.120	.039	.017	.0090	.0072	.038	.012	.0054	.0027	.0022	.014	.0040	.720	.200	.084	.055	.047
N1500	.420	.120	.055	.030	.025	.600	.170	.072	.043	.036	.200	.060	.027	.015	.012	.060	.020	.0084	.0043	.0037	.023	.0066	1.10	.310	.130	.090	.078
X7R	3.30	.780	.450	.200	.150	4.70	1.00	.600	.280	.230	1.50	.410	.210	.096	.072	.490	.120	---	---	---	.180	---	9.00	2.10	1.30	.600	.510

Max Capacitance (µF) Available Versus Style with Height (A) of 0.480" - 12.2mm

AVX STYLE	HV01 _____ AN480					HV02 _____ AN480					HV03 _____ AN480					HV04 _____ AN480					HV05 _____ AN480		HV06 _____ AN480				
	1KV	2KV	3KV	4KV	5KV	1KV	2KV	3KV	4KV	5KV	1KV	2KV	3KV	4KV	5KV	1KV	2KV	3KV	4KV	5KV	1KV	2KV	1KV	2KV	3KV	4KV	5KV
C0G	.340	.096	.044	.024	.020	.480	.130	.063	.035	.030	.160	.052	.023	.012	.0096	.051	.016	.0072	.0036	.0029	.019	.0054	.960	.260	.110	.073	.062
N1500	.560	.160	.073	.040	.033	.800	.230	.096	.057	.048	.270	.080	.036	.020	.016	.080	.026	.011	.0057	.0050	.031	.0088	1.50	.420	.180	.120	.100
X7R	4.40	1.00	.600	.260	.200	6.30	1.40	.800	.370	.310	2.00	.550	.280	.120	.096	.650	.160	---	---	---	.240	---	12.0	2.80	1.70	.800	.68

Max Capacitance (µF) Available Versus Style with Height (A) of 0.650" - 16.5mm

AVX STYLE	HV01 _____ AN650					HV02 _____ AN650					HV03 _____ AN650					HV04 _____ AN650					HV05 _____ AN650		HV06 _____ AN650				
	1KV	2KV	3KV	4KV	5KV	1KV	2KV	3KV	4KV	5KV	1KV	2KV	3KV	4KV	5KV	1KV	2KV	3KV	4KV	5KV	1KV	2KV	1KV	2KV	3KV	4KV	5KV
C0G	.430	.120	.056	.031	.026	.610	.170	.079	.044	.037	.210	.065	.029	.015	.012	.064	.020	.009	.0045	.0037	.024	.0068	1.20	.330	.140	.092	.078
N1500	.700	.210	.092	.050	.042	1.00	.290	.120	.072	.060	.340	.100	.045	.025	.020	.100	.033	.014	.0072	.0063	.039	.011	1.90	.530	.230	.150	.130
X7R	5.50	1.30	.750	.330	.260	7.90	1.80	1.00	.470	.390	2.60	.690	.360	.160	.120	.820	.210	---	---	---	.300	---	15.0	3.50	2.20	1.00	.850

COG Dielectric General Specifications

Capacitance Range
 100 pF to 1.2 μF
 (25°C, 1.0±0.2 Vrms (open circuit voltage)
 at 1 KHz, for ≤100 pF use 1 MHz)

Capacitance Tolerances
 ±5%, ±10%, ±20%

Operating Temperature Range
 -55°C to +125°C

Temperature Characteristic
 0 ± 30 ppm/°C

Voltage Ratings
 1000 VDC thru 5000 VDC (+125°C)

Dissipation Factor
 0.15% max.
 (25°C, 1.0±0.2 Vrms (open circuit voltage)
 at 1 KHz, for ≤100 pF use 1 MHz)

Insulation Resistance (+25°C, at 500V)
 100K MΩ min., or 1000 MΩ-μF min.,
 whichever is less

Insulation Resistance (+125°C, at 500V)
 10K MΩ min., or 100 MΩ-μF min.,
 whichever is less

Dielectric Strength
 120% rated voltage, 5 seconds

Life Test
 100% rated and +125°C

N1500 General Specifications

Capacitance Range
 100 pF to 1.9 μF
 (25°C, 1.0±0.2 Vrms (open circuit voltage)
 at 1 KHz)

Capacitance Tolerances
 ±5%, ±10%, ±20%

Operating Temperature Range
 -55°C to +125°C

Temperature Characteristic
 -1500 ±250 ppm/°C

Voltage Ratings
 1000 VDC thru 5000 VDC (+125°C)

Dissipation Factor
 0.15% max.
 (25°C, 1.0±0.2 Vrms (open circuit voltage)
 at 1 KHz)

Insulation Resistance (+25°C, at 500V)
 100K MΩ min., or 1000 MΩ-μF min.,
 whichever is less

Insulation Resistance (+125°C, at 500V)
 10K MΩ min., or 100 MΩ-μF min.,
 whichever is less

Dielectric Strength
 120% rated voltage, 5 seconds

Life Test
 100% rated and +125°C

X7R Dielectric General Specifications

Capacitance Range
 100 pF to 15 μF
 (25°C, 1.0±0.2 Vrms (open circuit voltage)
 at 1 KHz)

Capacitance Tolerances
 ±10%, ±20%, +80%, -20%

Operating Temperature Range
 -55°C to +125°C

Temperature Characteristic
 ±15% (0 VDC)

Voltage Ratings
 1000 VDC thru 5000 VDC (+125°C)

Dissipation Factor
 2.5% max.
 (25°C, 1.0±0.2 Vrms (open circuit voltage)
 at 1 KHz)

Insulation Resistance (+25°C, at 500V)
 100K MΩ min., or 1000 MΩ-μF min.,
 whichever is less

Insulation Resistance (+125°C, at 500V)
 10K MΩ min., or 100 MΩ-μF min.,
 whichever is less

Dielectric Strength
 120% rated voltage, 5 seconds

Life Test
 100% rated and +125°C

HOW TO ORDER

RV	01	A	C	105	M	A	N	650
AVX Style	Size See Dimensions chart	Voltage 1K = A 2K = G 3K = H 4K = J 5K = K	Temperature Coefficient COG = A X7R = C N1500 = 4	Capacitance Code (2 significant digits + number of zeros) 10 pF = 100 100 pF = 101 1,000 pF = 102 22,000 pF = 223 220,000 pF = 224 1 μF = 105 10 μF = 106 100 μF = 107	Capacitance Tolerance COG: J = ±5% K = ±10% M = ±20% X7R: K = ±10% M = ±20% Z = +80%, -20% N1500: J = ±5% K = ±10% M = ±20%	Test Level A = Does not apply	Termination N = Straight Lead J = Leads formed in L = Leads formed out P = P Style Leads Z = Z Style Leads	Height Max Dimension "A" 120 = 0.120" 240 = 0.240" 360 = 0.360" 480 = 0.480" 650 = 0.650"



Note: Capacitors with X7R dielectrics are not intended for applications across AC supply mains or AC line filtering with polarity reversal. Contact plant for recommendations.

High Voltage MLC Ledged

RV Style – RoHS Compliant High Voltage DIP Ledged

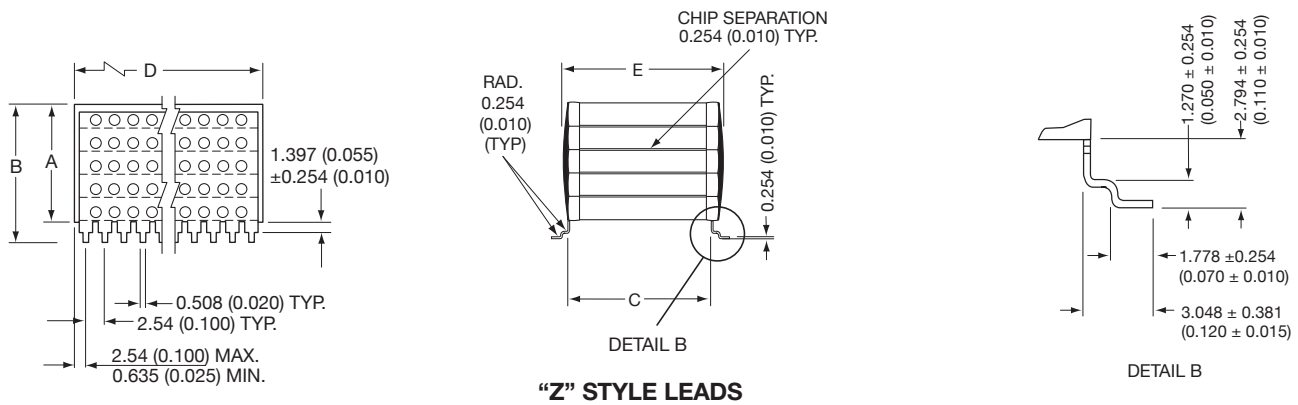
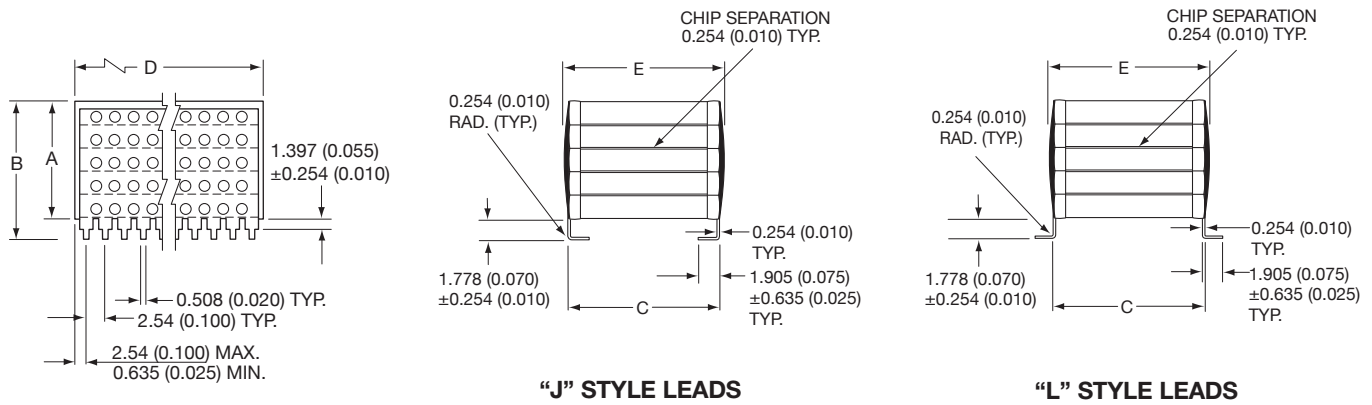
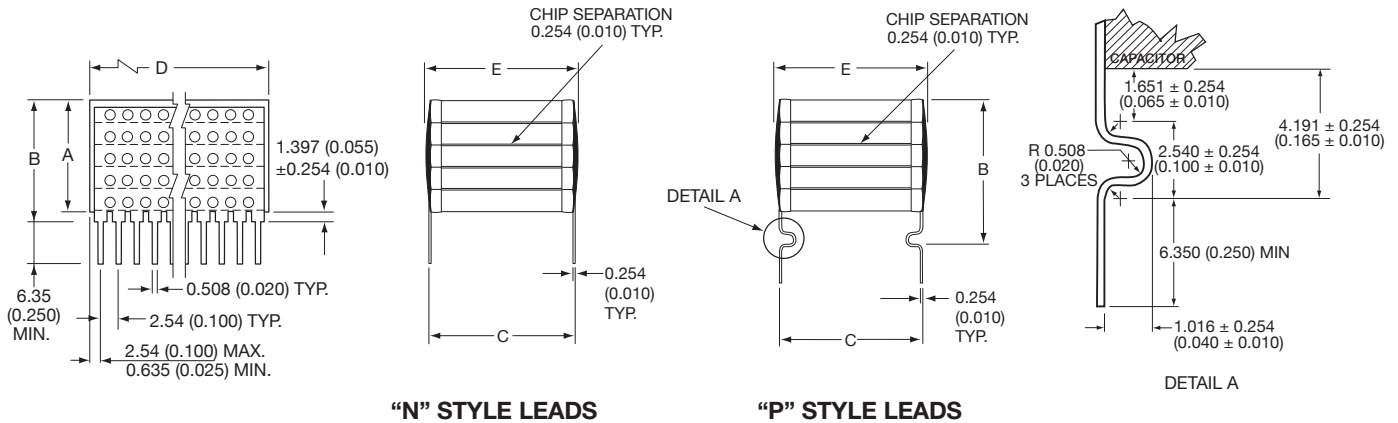

DIMENSIONS

millimeters (inches)

Style	A (max.)	B (max.)	C ± 0.635 (±0.025)	D ± 0.635 (±0.025)	E (max.)	No. of Leads per side
RV01	See page 86 for maximum "A" Dimension	For "N" Style Leads: "A" Dimension Plus 1.651 (0.065) For "J" & "L" Style Leads: "A" Dimension Plus 2.032 (0.080) For "P" Style Leads: "A" Dimension Plus 4.445 (0.175) For "Z" Style Leads: "A" Dimension Plus 3.048 (0.120)	53.3 (2.100)	10.5 (0.415)	54.9 (2.160)	4
RV02			39.1 (1.540)	20.3 (0.800)	40.7 (1.600)	8
RV03			27.2 (1.070)	10.5 (0.415)	28.2 (1.130)	4
RV04			10.2 (0.400)	10.2 (0.400)	11.2 (0.440)	4
RV05			6.35 (0.250)	6.35 (0.250)	7.62 (0.300)	3
RV06			53.3 (2.100)	29.0 (1.140)	54.9 (2.160)	11

High Voltage MLC Ledged

RV Style – RoHS Compliant High Voltage DIP Ledged



Max Capacitance (µF) Available Versus Style with Height (A) of 0.120" - 3.05mm

AVX STYLE	RV01 AN120					RV02 AN120					RV03 AN120					RV04 AN120					RV05 AN120		RV06 AN120					
	1KV	2KV	3KV	4KV	5KV	1KV	2KV	3KV	4KV	5KV	1KV	2KV	3KV	4KV	5KV	1KV	2KV	3KV	4KV	5KV	1KV	2KV	1KV	2KV	1KV	2KV	3KV	4KV
COG	.086	.024	.011	.0062	.0052	.120	.034	.015	.0088	.0074	.042	.013	.0058	.0030	.0024	.012	.0040	.0018	.0009	.0007	.0048	.0013	.240	.066	.028	.018	.015	
N1500	.140	.042	.018	.010	.0084	.200	.058	.024	.014	.012	.068	.020	.0090	.0050	.0040	.020	.0066	.0028	.0014	.0012	.0078	.0022	.380	.100	.046	.030	.026	
X7R	1.10	.260	.150	.066	.052	1.50	.360	.200	.094	.078	.520	.130	.072	.032	.024	.160	.042	---	---	---	.060	---	3.00	.700	.440	.200	.170	

Max Capacitance (µF) Available Versus Style with Height (A) of 0.240" - 6.10mm

AVX STYLE	RV01 AN240					RV02 AN240					RV03 AN240					RV04 AN240					RV05 AN240		RV06 AN240				
	1KV	2KV	3KV	4KV	5KV	1KV	2KV	3KV	4KV	5KV	1KV	2KV	3KV	4KV	5KV	1KV	2KV	3KV	4KV	5KV	1KV	2KV	1KV	2KV	3KV	4KV	5KV
COG	.170	.048	.022	.012	.010	.240	.068	.031	.017	.015	.084	.026	.011	.0060	.0048	.025	.0082	.0036	.0018	.0014	.0096	.0027	.480	.130	.056	.036	.031
N1500	.280	.084	.036	.020	.016	.400	.110	.048	.028	.024	.130	.040	.018	.010	.0080	.040	.013	.0056	.0028	.0025	.015	.0044	.760	.210	.092	.060	.052
X7R	2.20	.520	.300	.130	.100	3.10	.720	.400	.180	.150	1.00	.270	.140	.064	.048	.330	.084	---	---	---	.120	---	6.00	1.40	.880	.400	.340

Max Capacitance (µF) Available Versus Style with Height (A) of 0.360" - 9.15mm

AVX STYLE	RV01 AN360					RV02 AN360					RV03 AN360					RV04 AN360					RV05 AN360		RV06 AN360				
	1KV	2KV	3KV	4KV	5KV	1KV	2KV	3KV	4KV	5KV	1KV	2KV	3KV	4KV	5KV	1KV	2KV	3KV	4KV	5KV	1KV	2KV	1KV	2KV	3KV	4KV	5KV
COG	.250	.072	.033	.018	.015	.360	.100	.047	.026	.022	.120	.039	.017	.0090	.0072	.038	.012	.0054	.0027	.0022	.014	.0040	.720	.200	.084	.055	.047
N1500	.420	.120	.055	.030	.025	.600	.170	.072	.043	.036	.200	.060	.027	.015	.012	.060	.020	.0084	.0043	.0037	.023	.0066	1.10	.310	.130	.090	.078
X7R	3.30	.780	.450	.200	.150	4.70	1.00	.600	.280	.230	1.50	.410	.210	.096	.072	.490	.120	---	---	---	.180	---	9.00	2.10	1.30	.600	.510

Max Capacitance (µF) Available Versus Style with Height (A) of 0.480" - 12.2mm

AVX STYLE	RV01 AN480					RV02 AN480					RV03 AN480					RV04 AN480					RV05 AN480		RV06 AN480				
	1KV	2KV	3KV	4KV	5KV	1KV	2KV	3KV	4KV	5KV	1KV	2KV	3KV	4KV	5KV	1KV	2KV	3KV	4KV	5KV	1KV	2KV	1KV	2KV	3KV	4KV	5KV
COG	.340	.096	.044	.024	.020	.480	.130	.063	.035	.030	.160	.052	.023	.012	.0096	.051	.016	.0072	.0036	.0029	.019	.0054	.960	.260	.110	.073	.062
N1500	.560	.160	.073	.040	.033	.800	.230	.096	.057	.048	.270	.080	.036	.020	.016	.080	.026	.011	.0057	.0050	.031	.0088	1.50	.420	.180	.120	.100
X7R	4.40	1.00	.600	.260	.200	6.30	1.40	.800	.370	.310	2.00	.550	.280	.120	.096	.650	.160	---	---	---	.240	---	12.0	2.80	1.70	.800	.68

Max Capacitance (µF) Available Versus Style with Height (A) of 0.650" - 16.5mm

AVX STYLE	RV01 AN650					RV02 AN650					RV03 AN650					RV04 AN650					RV05 AN650		RV06 AN650				
	1KV	2KV	3KV	4KV	5KV	1KV	2KV	3KV	4KV	5KV	1KV	2KV	3KV	4KV	5KV	1KV	2KV	3KV	4KV	5KV	1KV	2KV	1KV	2KV	3KV	4KV	5KV
COG	.430	.120	.056	.031	.026	.610	.170	.079	.044	.037	.210	.065	.029	.015	.012	.064	.020	.009	.0045	.0037	.024	.0068	1.20	.330	.140	.092	.078
N1500	.700	.210	.092	.050	.042	1.00	.290	.120	.072	.060	.340	.100	.045	.025	.020	.100	.033	.014	.0072	.0063	.039	.011	1.90	.530	.230	.150	.130
X7R	5.50	1.30	.750	.330	.260	7.90	1.80	1.00	.470	.390	2.60	.690	.360	.160	.120	.820	.210	---	---	---	.300	---	15.0	3.50	2.20	1.00	.850

High Voltage MLC Leaded

CH Style – Radial, Dual-in-line & 'L' Lead SMT

Capacitance range: 1.2 nF to 2.7 μ F
 Voltage range: 1kV to 5kV
 Temperature range: -55°C to +125°C

This range of radial, dual-in-line for both through hole and surface mount products is intended for use in high voltage power supplies and voltage multiplier circuits. The multilayer ceramic construction offers excellent volumetric efficiency compared with other high voltage dielectrics. They are suitable for both high reliability and industrial applications.

ELECTRICAL SPECIFICATIONS

Temperature Coefficient CECC 30 000, (4.24.1)
 2C1/X7R: C Temperature Characteristic - \pm 15% (0v dc)

Capacitance Test 25°C
 2C1/X7R: Measured at 1 VRMS max at 1KHz

Dissipation Factor 25°C
 2C1/X7R: 2.5% max at 1KHz, 1 VRMS

Insulation Resistance
 2C1/X7R: 100K megohms or 1000 megohms- μ F, whichever is less

Dielectric Withstanding Voltage 25°C
 130% rated voltage for 5 seconds

Life Test (1000 hrs) CECC 30000 (4.23)
 12C1/X7R: 120% rated voltage at +125°C.

Aging
 2C1/X7R: 2.5%/decade hour

DUAL-IN-LINE

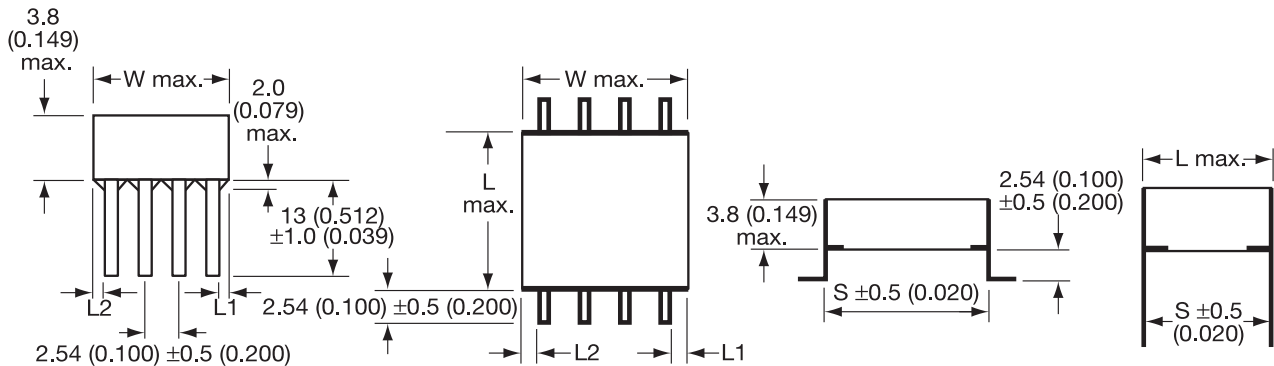

DIMENSIONS

millimeters (inches)

Style	L (max)	W (max)	S (nom)	No. of Leads per side
CH41	9.2 (0.362)	8.7 (0.342)	8.2 (0.323)	3
CH51	10.7 (0.421)	10.7 (0.421)	10.2 (0.400)	4
CH61	14.9 (0.587)	13.6 (0.535)	14.0 (0.551)	5
CH76	21.6 (0.850)	16.6 (0.654)	20.3* (0.800)	6
CH91	24.0 (0.944)	40.6 (1.598)	20.3* (0.800)	14

Lead width 0.5 (0.020)
 Lead thickness 0.254 (0.010)
 L1 = L2 \pm 0.5 (0.020)

*Tolerance \pm 0.8

HOW TO ORDER

CH	41	A	C	104	K	A	8	0	A	7
Style Code	Size Code	Voltage Code	Dielectric Code	Capacitance Code	Capacitance Tolerance	Specification Code	Finish Code	Lead Dia. Code	Lead Space Code	Lead Style Code
		A = 1kV G = 2kV H = 3kV J = 4kV K = 5kV	C = X7R	(2 significant digits + no. of zeros) eg. 105 = 1 μ F 106 = 10 μ F 107 = 100 μ F	X7R: K = \pm 10%A M = \pm 20% P = +100,-0%	Non-customized	8 = Varnish	0 = Standard	A = Standard	0 = Dual in line straight 7 = Dual in line 'L' style

Not RoHS Compliant

Performance of SMPS capacitors can be simulated by downloading SpiCalci software program - <http://www.avx.com/download/software/SpiCalci-AVX.zip>
 Custom values, ratings and configurations are also available.

High Voltage MLC Leaded

CV Style – Chip Assemblies

VERTICALLY MOUNTED RADIAL PRODUCT

Part Number format (CVxxxxxxxxxxxA2)

Typical Part Number CV51AC154MA80A2

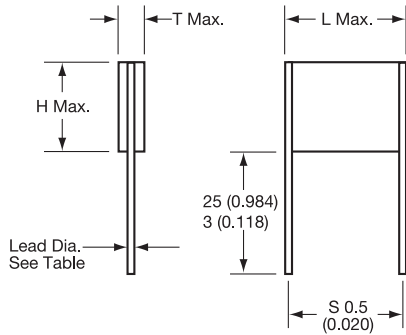

DIMENSIONS

millimeters (inches)

Style	L (max)	H (max)	T (max)	S (nom)	Lead Dia (nom)
CV41	10.6 (0.417)	8.70 (0.343)	3.80 (0.150)	8.20 (0.323)	0.70 (0.028)
CV51	11.9 (0.469)	10.7 (0.421)	3.80 (0.150)	10.2 (0.402)	0.90 (0.035)
CV61	16.5 (0.650)	13.6 (0.536)	3.80 (0.150)	15.2 (0.599)	0.90 (0.035)
CV76	22.7 (0.893)	16.6 (0.654)	3.80 (0.150)	21.2* (0.835)	0.90 (0.035)
CV91	24.0 (0.944)	40.6 (1.598)	3.80 (0.150)	21.2* (0.835)	1.20 (0.047)

*Tolerance ± 0.8mm (0.031)

Not RoHS Compliant

HOW TO ORDER

CV	51	A	C	154	M	A	8	0	A	2
Style Code	Size Code	Voltage Code	Dielectric Code	Capacitance Code	Capacitance Tolerance	Specification Code	Finish Code	Lead Dia. Code	Lead Space Code	Lead Style Code
		A = 1kV G = 2kV H = 3kV J = 4kV K = 5kV	c = X7R	(2 significant digits + no. of zeros) eg. 105 = 1 uF 106 = 10 uF 107 = 100 uF	X7R: K = ±10% M = ±20% P = +100, -0%	Non-customized	8 = Varnish	0 = Standard	A = Standard	

High Voltage MLC Leaded

CH/CV Style – Chip Assemblies



2C1/X7R STABLE CERAMIC

Cap nF	CV41-CH41 Styles					CV51-CH51 Styles					CV61-CH61 Styles					CV76-CH76 Styles					CV91-CH91 Styles				
	1 Kv	2 Kv	3 Kv	4 Kv	5 Kv	1 Kv	2 Kv	3 Kv	4 Kv	5 Kv	1 Kv	2 Kv	3 Kv	4 Kv	5 Kv	1 Kv	2 Kv	3 Kv	4 Kv	5 Kv	1 Kv	2 Kv	3 Kv	4 Kv	5 Kv
1.2					K																				
1.3					K																				
1.5				J	K																				
2.2				J	K																				
2.7				J	K																				
3.3				J									K												
3.9				J									K												
4.7			H	J								J											K		
5.6			H									J											K		
6.8			H									J											K		
8.2		G	H									J											K		
10		G																					K		
12		G																					K		
15		G																					K		
18	A							G	H													J	K		
22	A							G														J		K	
27	A							G														J		K	
33	A							G														J		K	
39	A					A								G	H							J		K	
47	A					A								G								H		K	
56	A					A								G								H		K	
68	A					A								G								H		K	
82	A					A								G									J		
100	A					A						A										G		J	
120	A					A						A										G		J	
150						A						A										G			
180						A						A										A			
220						A						A										G			
270						A						A										G			
330												A											G		
390												A										A			
470												A										A			
560												A										A			
680												A										A			
820												A										A			
1000												A										A			
1200																						A			
1500																						A			
1800																						A			
2200																						A			
2700																						A			

NB Figures in cells refer to size within ordering information

High Voltage MLC Ledged

SV Style Radial Lead – Application Information

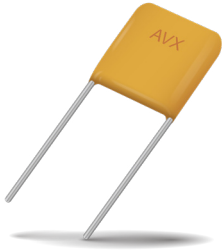

High value, low leakage and small size are difficult parameters to obtain in capacitors for high voltage systems. AVX special high voltage MLC radial leaded capacitors meet these performance characteristics. The added advantage of these capacitors lies in special internal design minimizing the electric field stresses within the MLC. These special design criteria result in significant reduction of partial discharge activity within the dielectric and having, therefore, a major impact on long-term reliability of the product. The SV high voltage radial capacitors are conformally coated with high insulation resistance, high dielectric strength epoxy eliminating the possibility of arc flashover.

The SV high voltage radial MLC designs exhibit low ESRs at high frequency. The same criteria governing the high voltage design carries the added benefits of extremely low ESR in relatively low capacitance and small packages. These capacitors are designed and are ideally suited for applications such as snubbers in high frequency power converters, resonators in SMPS, and high voltage coupling/DC blocking.

COG Dielectric General Specifications

Capacitance Range

10 pF to 0.15 μ F
(+25°C, 1.0 \pm 0.2 Vrms at 1kHz,
for \leq 100 pF use 1 MHz)

Capacitance Tolerances

\pm 5%, \pm 10%, \pm 20%

Operating Temperature Range

-55°C to +125°C

Temperature Characteristic

0 \pm 30 ppm/°C

Voltage Ratings

600 VDC thru 5000 VDC (+125°C)

Dissipation Factor

0.15% max.
(+25°C, 1.0 \pm 0.2 Vrms at 1kHz,
for \leq 100 pF use 1 MHz)

Insulation Resistance (+25°C, at 500V)

100K M Ω min., or 1000 M Ω - μ F min.,
whichever is less

Insulation Resistance (+125°C, at 500V)

10K M Ω min., or 100 M Ω - μ F min.,
whichever is less

Dielectric Strength

120% rated voltage, 5 seconds

Life Test

100% rated and +125°C

N1500 General Specifications

Capacitance Range

100 pF to 0.47 μ F
(+25°C, 1.0 \pm 0.2 Vrms (open circuit voltage)
at 1kHz)

Capacitance Tolerances

\pm 5%, \pm 10%, \pm 20%
Operating Temperature Range
-55°C to +125°C

Temperature Characteristic

-1500 \pm 250 ppm/°C

Voltage Ratings

600 VDC thru 5000 VDC (+125°C)

Dissipation Factor

0.15% max.
(25°C, 1.0 \pm 0.2 Vrms (open circuit voltage)
at 1 KHz)

Insulation Resistance (+25°C, at 500V)

100K M Ω min., or 1000 M Ω - μ F min.,
whichever is less

Insulation Resistance (+125°C, at 500V)

10K M Ω min., or 100 M Ω - μ F min.,
whichever is less

Dielectric Strength

120% rated voltage, 5 seconds

Life Test

100% rated and +125°C

X7R Dielectric General Specifications

Capacitance Range

100 pF to 2.2 μ F
(+25°C, 1.0 \pm 0.2 Vrms at 1kHz)

Capacitance Tolerances

\pm 10%, \pm 20%, +80%, -20%

Operating Temperature Range

-55°C to +125°C

Temperature Characteristic

\pm 15% (0 VDC)

Voltage Ratings

600 VDC thru 5000 VDC (+125°C)

Dissipation Factor

2.5% max.
(+25°C, 1.0 \pm 0.2 Vrms at 1kHz)

Insulation Resistance (+25°C, at 500V)

100K M Ω min., or 1000 M Ω - μ F min.,
whichever is less

Insulation Resistance (+125°C, at 500V)

10K M Ω min., or 100 M Ω - μ F min.,
whichever is less

Dielectric Strength

120% rated voltage, 5 seconds

Life Test

100% rated and +125°C

Performance of SMPS capacitors can be simulated by downloading SpiCalci software program -
<http://www.avx.com/download/software/SpiCalci-AVX.zip>
Custom values, ratings and configurations are also available.

High Voltage MLC Ledged

SV Style Radial Lead – Application Information

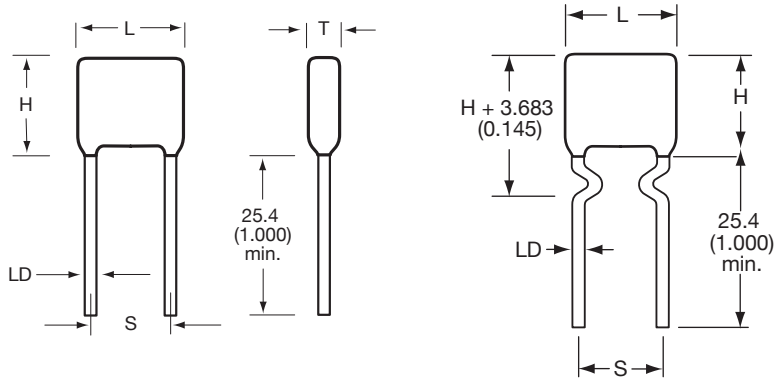

SV01 thru SV17

SV52 thru SV59 and SV63 thru SV67

Not RoHS Compliant



For RoHS compliant products, please select correct termination style.

HIGH VOLTAGE RADIAL LEAD

HOW TO ORDER

AVX Styles: SV01 THRU SV67

SV01	A	A	102	K	A	A	*
AVX Style	Voltage	Temperature Coefficient	Capacitance Code (2 significant digits + no. of zeros)	Capacitance Tolerance	Test Level	Leads	Packaging (See Note 1)
	600V/630V = C 1000V = A 1500V = S 2000V = G 2500V = W 3000V = H 4000V = J 5000V = K	C0G = A X7R = C N1500 = 4	Examples: 10 pF = 100 100 pF = 101 1.000pF = 102 22.000pF = 223 220.000pF = 224 1 μF=105	C0G: J = ±5% K = ±10% M = ±20% X7R: K = ±10% M = ±20% Z = +80 -20%	A = Standard B = Hi-Rel*	A = Tin/Lead R = R o H S Compliant*	

Note 1: No suffix signifies bulk packaging which is AVX standard packaging. Use suffix "TR1" if tape and reel is required. Parts are reel packaged per EIA-468.

Note: Capacitors with X7R dielectrics are not intended for applications across AC supply mains or AC line filtering with polarity reversal. Contact plant for recommendations.

*Hi-Rel screening consists of 100% Group A, Subgroup 1 per MIL-PRF-49467. (Except partial discharge testing is not performed and DWV is at 120% rated voltage).

DIMENSIONS

millimeters (inches)

AVX Style	Length (L) max	Height (H) max	Thickness (T) max	Lead Spacing ±.762 (.030) (S)	LD (Nom)
SV01	6.35 (0.250)	5.59 (0.220)	5.08 (0.200)	4.32 (0.170)	0.64 (0.025)
SV02/SV52	8.13 (0.320)	7.11 (0.280)	5.08 (0.200)	5.59 (0.220)	0.64 (0.025)
SV03/SV53	9.40 (0.370)	7.62 (0.300)	5.08 (0.200)	6.99 (0.275)	0.64 (0.025)
SV04/SV54	11.4 (0.450)	5.59 (0.220)	5.08 (0.200)	7.62 (0.300)	0.64 (0.025)
SV05/SV55	11.9 (0.470)	10.2 (0.400)	5.08 (0.200)	9.52 (0.375)	0.64 (0.025)
SV06/SV56	14.0 (0.550)	7.11 (0.280)	5.08 (0.200)	10.16 (0.400)	0.64 (0.025)
SV07/SV57	14.5 (0.570)	12.7 (0.500)	5.08 (0.200)	12.1 (0.475)	0.64 (0.025)
SV08/SV58	17.0 (0.670)	15.2 (0.600)	5.08 (0.200)	14.6 (0.575)	0.64 (0.025)
SV09/SV59	19.6 (0.770)	18.3 (0.720)	5.08 (0.200)	17.1 (0.675)	0.64 (0.025)
SV10	26.7 (1.050)	12.7 (0.500)	5.08 (0.200)	22.9 (0.900)	0.64 (0.025)
SV11	31.8 (1.250)	15.2 (0.600)	5.08 (0.200)	27.9 (1.100)	0.64 (0.025)
SV12	36.8 (1.450)	18.3 (0.720)	5.08 (0.200)	33.0 (1.300)	0.64 (0.025)
SV13/SV63	7.62 (0.300)	9.14 (0.360)	5.08 (0.200)	5.08 (0.200)	0.51 (0.020)
SV14/SV64	10.2 (0.400)	11.7 (0.460)	5.08 (0.200)	5.08 (0.200)	0.51 (0.020)
SV15/SV65	12.7 (0.500)	14.2 (0.560)	5.08 (0.200)	10.2 (0.400)	0.64 (0.025)
SV16/SV66	22.1 (0.870)	16.8 (0.660)	5.08 (0.200)	20.1 (0.790)	0.81 (0.032)
SV17/SV67	23.6 (0.930)	19.8 (0.780)	6.35 (0.250)	20.3 (0.800)	0.81 (0.032)

TAPE & REEL QUANTITY	
Part	Pieces
SV01	1000
SV02/SV52	1000
SV03/SV53	1000
SV04/SV54	1000
SV05/SV55	1000
SV06/SV56	500
SV07/SV57	500
SV08/SV58	500
SV09/SV59	500
SV10	N/A
SV11	N/A
SV12	N/A
SV13/SV63	1000
SV14/SV64	1000
SV15/SV65	500
SV16/SV66	500
SV17/SV67	400

RoHS	
Part	Available
SV01	Yes
SV02/SV52	Yes
SV03/SV53	Yes
SV04/SV54	Yes
SV05/SV55	Yes
SV06/SV56	Yes
SV07/SV57	Yes
SV08/SV58	Yes
SV09/SV59	Yes
SV10	Yes
SV11	Yes
SV12	Yes
SV13/SV63	Yes
SV14/SV64	Yes
SV15/SV65	Yes
SV16/SV66	Yes
SV17/SV67	Yes

High Voltage MLC Leaded

SV Style Radial Lead – Application Information



CAPACITANCE VALUE

COG								
Style	600/630V min./max.	1000V min./max.	1500V min./max.	2000V min./max.	2500V min./max.	3000V min./max.	4000V min./max.	5000V min./max.
SV01	100 pF / 1500 pF	100 pF / 1000 pF	10 pF / 330 pF	10 pF / 220 pF	10 pF / 120 pF	10 pF / 82 pF	–	–
SV02/SV52	100 pF / 6800 pF	100 pF / 4700 pF	100 pF / 1500 pF	10 pF / 1000 pF	10 pF / 680 pF	10 pF / 560 pF	10 pF / 150 pF	10 pF / 100 pF
SV03/SV53	100 pF / 0.012 μF	100 pF / 8200 pF	100 pF / 2700 pF	100 pF / 1800 pF	10 pF / 1000 pF	10 pF / 680 pF	10 pF / 390 pF	10 pF / 220 pF
SV04/SV54	100 pF / 3900 pF	100 pF / 2700 pF	10 pF / 820 pF	10 pF / 560 pF	10 pF / 270 pF	10 pF / 180 pF	10 pF / 100 pF	10 pF / 68 pF
SV05/SV55	1000 pF / 0.027 μF	1000 pF / 0.018 μF	100 pF / 6800 pF	100 pF / 4700 pF	100 pF / 2700 pF	100 pF / 1500 pF	10 pF / 1000 pF	10 pF / 560 pF
SV06/SV56	100 pF / 0.012 μF	100 pF / 0.010 μF	100 pF / 3300 pF	100 pF / 2200 pF	10 pF / 1200 pF	10 pF / 820 pF	10 pF / 470 pF	10 pF / 390 pF
SV07/SV57	1000 pF / 0.056 μF	1000 pF / 0.033 μF	1000 pF / 0.015 μF	100 pF / 0.010 μF	100 pF / 5600 pF	100 pF / 3900 pF	100 pF / 2200 pF	10 pF / 1200 pF
SV08/SV58	1000 pF / 0.082 μF	1000 pF / 0.047 μF	1000 pF / 0.022 μF	1000 pF / 0.015 μF	100 pF / 0.010 μF	100 pF / 6800 pF	100 pF / 3300 pF	100 pF / 2200 pF
SV09/SV59	1000 pF / 0.150 μF	1000 pF / 0.082 μF	1000 pF / 0.039 μF	1000 pF / 0.022 μF	1000 pF / 0.015 μF	100 pF / 8200 pF	100 pF / 4700 pF	100 pF / 3300 pF
SV10	1000 pF / 0.100 μF	1000 pF / 0.056 μF	1000 pF / 0.022 μF	1000 pF / 0.012 μF	100 pF / 8200 pF	100 pF / 5600 pF	100 pF / 3300 pF	100 pF / 2200 pF
SV11	1000 pF / 0.150 μF	1000 pF / 0.082 μF	1000 pF / 0.039 μF	1000 pF / 0.022 μF	1000 pF / 0.015 μF	100 pF / 8200 pF	100 pF / 4700 pF	100 pF / 3300 pF
SV12	0.01 μF / 0.220 μF	0.01 μF / 0.15 μF	1000 pF / 0.056 μF	1000 pF / 0.033 μF	1000 pF / 0.022 μF	1000 pF / 0.015 μF	100 pF / 8200 pF	100 pF / 5600 pF
SV13/SV63	100 pF / 0.018 μF	100 pF / 0.012 μF	100 pF / 4700 pF	100 pF / 2700 pF	100 pF / 1800 pF	100 pF / 1000 pF	10 pF / 470 pF	10 pF / 390 pF
SV14/SV64	1000 pF / 0.039 μF	1000 pF / 0.022 μF	100 pF / 8200 pF	100 pF / 5600 pF	100 pF / 3300 pF	100 pF / 1800 pF	10 pF / 820 pF	10 pF / 680 pF
SV15/SV65	1000 pF / 0.056 μF	1000 pF / 0.033 μF	1000 pF / 0.015 μF	100 pF / 0.01 μF	100 pF / 5600 pF	100 pF / 2700 pF	100 pF / 1800 pF	100 pF / 1200 pF
SV16/SV66	1000 pF / 0.120 μF	1000 pF / 0.082 μF	1000 pF / 0.039 μF	1000 pF / 0.022 μF	1000 pF / 0.015 μF	100 pF / 8200 pF	100 pF / 4700 pF	100 pF / 3300 pF
SV17/SV67	1000 pF / 0.150 μF	1000 pF / 0.10 μF	1000 pF / 0.056 μF	1000 pF / 0.039 μF	1000 pF / 0.022 μF	1000 pF / 0.012 μF	100 pF / 6800 pF	100 pF / 4700 pF
N1500								
SV01	1000 pF / 2700 pF	1000 pF / 1800 pF	100 pF / 680 pF	100 pF / 470 pF	100 pF / 220 pF	100 pF / 150 pF	–	–
SV02/SV52	1000 pF / 0.012 μF	1000 pF / 8200 pF	1000 pF / 2700 pF	1000 pF / 1800 pF	100 pF / 1000 pF	100 pF / 680 pF	100 pF / 270 pF	100 pF / 150 pF
SV03/SV53	0.010 pF / 0.027 μF	0.010 pF / 0.018 μF	1000 pF / 5600 pF	1000 pF / 3900 pF	1000 pF / 2200 pF	1000 pF / 1500 pF	100 pF / 680 pF	100 pF / 470 pF
SV04/SV54	1000 pF / 8200 pF	1000 pF / 5600 pF	1000 pF / 1800 pF	100 pF / 1200 pF	100 pF / 560 pF	100 pF / 330 pF	100 pF / 220 pF	100 pF / 120 pF
SV05/SV55	0.010 μF / 0.068 μF	0.010 μF / 0.047 μF	1000 pF / 0.015 μF	1000 pF / 0.010 μF	1000 pF / 5600 pF	1000 pF / 3300 pF	1000 pF / 2200 pF	1000 pF / 1200 pF
SV06/SV56	0.010 μF / 0.027 μF	0.010 μF / 0.018 μF	1000 pF / 5600 pF	1000 pF / 3900 pF	1000 pF / 2200 pF	1000 pF / 1500 pF	100 pF / 680 pF	100 pF / 470 pF
SV07/SV57	0.010 μF / 0.12 μF	0.010 μF / 0.10 μF	0.010 μF / 0.027 μF	0.010 μF / 0.018 μF	1000 pF / 0.012 μF	1000 pF / 5600 pF	1000 pF / 3900 pF	1000 pF / 2200 pF
SV08/SV58	0.010 μF / 0.15 μF	0.010 μF / 0.12 μF	0.010 μF / 0.047 μF	0.010 pF / 0.033 μF	0.010 μF / 0.018 μF	1000 pF / 0.010 μF	1000 pF / 6800 pF	1000 pF / 3900 pF
SV09/SV59	0.10 μF / 0.220 μF	0.10 μF / 0.18 μF	0.010 μF / 0.082 μF	0.010 μF / 0.047 μF	0.010 pF / 0.033 μF	0.010 μF / 0.015 μF	1000 pF / 8200 pF	1000 pF / 6800 pF
SV10	0.10 μF / 0.18 μF	0.10 μF / 0.15 μF	0.010 μF / 0.047 μF	0.010 μF / 0.027 μF	0.010 μF / 0.018 μF	1000 pF / 0.010 μF	1000 pF / 5600 pF	1000 pF / 3900 pF
SV11	0.10 μF / 0.33 μF	0.10 μF / 0.22 μF	0.010 μF / 0.082 μF	0.010 μF / 0.039 μF	0.010 μF / 0.027 μF	0.010 μF / 0.018 μF	1000 pF / 0.010 μF	1000 pF / 6800 pF
SV12	0.10 μF / 0.47 μF	0.10 μF / 0.33 μF	0.10 μF / 0.12 μF	0.010 μF / 0.068 μF	0.010 pF / 0.047 μF	0.010 μF / 0.027 μF	0.010 pF / 0.015 μF	1000 pF / 0.010 μF
SV13/SV63	0.010 μF / 0.039 μF	0.010 μF / 0.027 μF	1000 pF / 8200 pF	1000 pF / 5600 pF	1000 pF / 3300 pF	1000 pF / 1800 pF	100 pF / 820 pF	100 pF / 680 pF
SV14/SV64	0.010 μF / 0.082 μF	0.010 μF / 0.056 μF	0.010 pF / 0.018 μF	1000 pF / 0.012 μF	1000 pF / 6800 pF	1000 pF / 3900 pF	1000 pF / 1800 pF	1000 pF / 1500 pF
SV15/SV65	0.010 μF / 0.10 μF	0.010 μF / 0.082 μF	0.010 μF / 0.027 μF	0.010 pF / 0.018 μF	1000 pF / 0.012 μF	1000 pF / 5600 pF	1000 pF / 3300 pF	1000 pF / 2700 pF
SV16/SV66	0.10 μF / 0.22 μF	0.10 μF / 0.18 μF	0.010 μF / 0.082 μF	0.010 pF / 0.039 μF	0.010 μF / 0.027 μF	0.010 μF / 0.015 μF	1000 pF / 8200 pF	1000 pF / 6800 pF
SV17/SV67	0.10 μF / 0.33 μF	0.10 μF / 0.22 μF	0.010 μF / 0.10 μF	0.010 μF / 0.056 μF	0.010 μF / 0.033 μF	0.010 μF / 0.022 μF	1000 pF / 0.012 μF	1000 pF / 0.010 μF
X7R								
SV01	1000 pF / 0.018 μF	1000 pF / 0.012 μF	100 pF / 5600 pF	100 pF / 3900 pF	–	–	–	–
SV02/SV52	1000 pF / 0.082 μF	1000 pF / 0.047 μF	1000 pF / 0.015 μF	100 pF / 6800 pF	100 pF / 3900 pF	100 pF / 2700 pF	–	–
SV03/SV53	1000 pF / 0.180 μF	1000 pF / 0.082 μF	1000 pF / 0.018 μF	1000 pF / 0.01 μF	100 pF / 6800 pF	100 pF / 4700 pF	100 pF / 1800 pF	–
SV04/SV54	1000 pF / 0.056 μF	1000 pF / 0.033 μF	100 pF / 6800 pF	100 pF / 3900 pF	100 pF / 2200 pF	100 pF / 1800 pF	100 pF / 820 pF	–
SV05/SV55	0.01 μF / 0.470 μF	0.01 μF / 0.22 μF	1000 pF / 0.056 μF	1000 pF / 0.027 μF	1000 pF / 0.018 μF	1000 pF / 0.012 μF	100 pF / 4700 pF	–
SV06/SV56	0.01 μF / 0.180 μF	0.01 μF / 0.10 μF	1000 pF / 0.033 μF	1000 pF / 0.012 μF	100 pF / 8200 pF	100 pF / 6800 pF	100 pF / 2700 pF	100 pF / 1200 pF
SV07/SV57	0.01 μF / 0.820 μF	0.01 μF / 0.39 μF	0.01 μF / 0.10 μF	1000 pF / 0.047 μF	1000 pF / 0.033 μF	1000 pF / 0.027 μF	1000 pF / 0.01 μF	100 pF / 6800 pF
SV08/SV58	0.01 μF / 1.20 μF	0.01 μF / 0.68 μF	0.01 μF / 0.18 μF	1000 pF / 0.082 μF	1000 pF / 0.068 μF	1000 pF / 0.047 μF	1000 pF / 0.018 μF	1000 pF / 0.012 μF
SV09/SV59	0.10 μF / 1.80 μF	0.10 μF / 1.00 μF	0.01 μF / 0.27 μF	0.01 μF / 0.12 μF	0.01 μF / 0.10 μF	1000 pF / 0.068 μF	1000 pF / 0.027 μF	1000 pF / 0.018 μF
SV10	0.01 μF / 1.50 μF	0.01 μF / 0.82 μF	0.01 μF / 0.22 μF	0.01 μF / 0.10 μF	1000 pF / 0.082 μF	1000 pF / 0.056 μF	1000 pF / 0.022 μF	1000 pF / 0.022 μF
SV11	0.10 μF / 2.20 μF	0.10 μF / 1.2 μF	0.01 μF / 0.39 μF	0.01 μF / 0.18 μF	0.01 μF / 0.15 μF	0.01 μF / 0.10 μF	1000 pF / 0.039 μF	1000 pF / 0.027 μF
SV12	0.10 μF / 3.90 μF	0.10 μF / 2.20 μF	0.01 μF / 0.56 μF	0.01 μF / 0.27 μF	0.01 μF / 0.22 μF	0.01 μF / 0.15 μF	1000 pF / 0.056 μF	1000 pF / 0.033 μF
SV13/SV63	0.01 μF / 0.270 μF	0.01 μF / 0.10 μF	1000 pF / 0.033 μF	1000 pF / 0.012 μF	1000 pF / 0.01 μF	100 pF / 6800 pF	100 pF / 2700 pF	–
SV14/SV64	0.01 μF / 0.470 μF	0.01 μF / 0.18 μF	1000 pF / 0.068 μF	1000 pF / 0.022 μF	1000 pF / 0.018 μF	1000 pF / 0.015 μF	100 pF / 5600 pF	–
SV15/SV65	0.01 μF / 0.680 μF	0.01 μF / 0.33 μF	0.01 μF / 0.10 μF	1000 pF / 0.033 μF	1000 pF / 0.027 μF	1000 pF / 0.022 μF	1000 pF / 8200 pF	100 pF / 4700 pF
SV16/SV66	0.01 μF / 1.80 μF	0.01 μF / 1.0 μF	0.01 μF / 0.27 μF	0.01 μF / 0.12 μF	0.01 μF / 0.10 μF	1000 pF / 0.068 μF	1000 pF / 0.027 μF	1000 pF / 0.018 μF
SV17/SV67	0.01 μF / 2.20 μF	0.01 μF / 1.2 μF	0.01 μF / 0.39 μF	0.01 μF / 0.15 μF	0.01 μF / 0.12 μF	1000 pF / 0.082 μF	1000 pF / 0.039 μF	1000 pF / 0.027 μF

Note: Contact factory for other voltage ratings or values.



The Important Information/Disclaimer is incorporated in the catalog where these specifications came from or available online at www.avx.com/disclaimer/ by reference and should be reviewed in full before placing any order.

High Voltage MLC Leaded

DSCC Radials



AVX IS QUALIFIED TO THE FOLLOWING DSCC DRAWINGS

Specification #	Description	Capacitance Range
87046	C0G-1000 VDC	10 pF - 0.025 µF
87043	X7R-1000 VDC	100 pF - 0.47 µF
87040	X7R-2000 VDC	100 pF - 0.22 µF
87114	C0G-3000 VDC	10 pF - 8200 pF
87047	X7R-3000 VDC	100 pF - 0.1 µF
87076	C0G-4000 VDC	10 pF - 6800 pF
89044	X7R-4000 VDC	100 pF - 0.056 µF
87077	C0G-5000 VDC	10 pF - 5600 pF
87070	X7R-5000 VDC	100 pF - 0.033 µF

Group A inspection

Inspection	Requirement paragraph of MIL-PRF-49467	Test method paragraph of MIL-PRF-49467	Sampling procedure
Subgroup 1			
Thermal Shock	3.6	4.8.2.1	100% inspection
Voltage Conditioning	3.6	4.8.2.2	
Subgroup 3			
Visual and mechanical examination:			13 samples 0 failures
Material	3.4 and 3.4.1	4.8.4	
Physical dimensions	3.1		
Interface requirements (other than physical dimensions)	3.5		
Marking	3.25		
Workmanship	3.27		
Subgroup 4			
Solderability	3.13	4.8.9	5 samples 0 failures

Group B inspection*

Inspection	Requirement paragraph of MIL-PRF-49467	Test method paragraph of MIL-PRF-49467	Number of sample units to be inspected	Number of defectives permitted	
Subgroup 1					
Terminal strength	3.18	4.8.14	12	1	1
Resistance to soldering heat	3.11	4.8.7			
Moisture resistance	3.19	4.8.15			
Subgroup 2					
Voltage-temperature limits**	3.14	4.8.10	6	1	
Low temperature storage	3.23	4.8.19			
Marking legibility	3.25.1	4.8.1.1			
Subgroup 3					
Resistance to solvents	3.21	4.8.17	4	1	
Subgroup 4					
Life (at elevated ambient temperature)	3.22	4.8.18	10	1	

*Customers may accept at their discretion, a certificate of compliance with group B requirements in lieu of performing group B tests.

**For Steps E, F & G in Table VII of MIL-PRF-49467, 500 Vdc shall be applied.

High Voltage MLC Ledged

SV Style Automotive Grade Radial Lead – Application Information

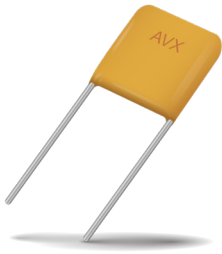

Automotive grade, AEC-Q200 qualified SV-style capacitors are designed with COG (NPO), class I dielectric that is characterized with very low dielectric losses. This product is designed for AC applications requiring capacitors capable of handling high AC currents at high frequencies.

With emergence of strongly coupled magnetic resonance technology that allows for highly efficient wireless transmission of power to recharge batteries, the need for low loss capacitors is apparent. Thanks to their extremely low dissipation factor, automotive grade SV-style parts can reliably handle high rms currents with minimal power losses in medium to high power resonant converters. Multiple parts in parallel may be required depending on the power transmission levels.

The automotive grade SV-style capacitors are conformally coated eliminating possibility of arc flashover. The leaded construction provides mechanical decoupling of MLCC chip from the board and thus provides effective stress relief required for automotive applications.

COG Dielectric General Specifications

Capacitance Range

1000pF to 0.015 μ F
(+25°C, 1.0 \pm 0.2 Vrms at 1kHz)

Capacitance Tolerances

\pm 5%, \pm 10%, \pm 20%

Operating Temperature Range

-55°C to +125°C

Temperature Characteristic

0 \pm 30 ppm/°C

Voltage Ratings

1000 VDC (+125°C)

Dissipation Factor

0.1% max.
(+25°C, 1.0 \pm 0.2 Vrms at 1kHz,

Insulation Resistance (+25°C, at 500V)

100K M Ω min. or 1000 M Ω - μ F min., whichever is less

Insulation Resistance (+125°C, at 500V)

10K M Ω min., or 100 M Ω - μ F min., whichever is less

Dielectric Strength

120% rated voltage, 5 seconds

Life Test

100% rated and +125°C

Typical Impedance and ESR Characterization

AVX P/N: SV05AA103K4R

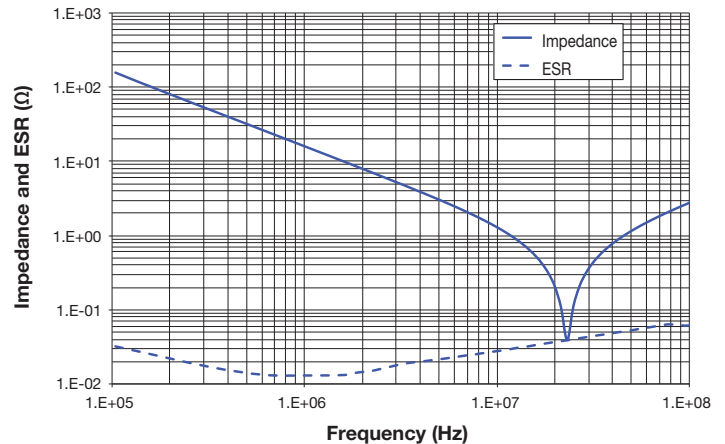

Performance of SMPS capacitors can be simulated by downloading SpiCalci software program -
<http://www.avx.com/download/software/SpiCalci-AVX.zip>
Custom values, ratings and configurations are also available.



The Important Information/Disclaimer is incorporated in the catalog where these specifications came from or available online at www.avx.com/disclaimer/ by reference and should be reviewed in full before placing any order.

High Voltage MLC Leaded

SV Style Automotive Grade Radial Lead – Application Information

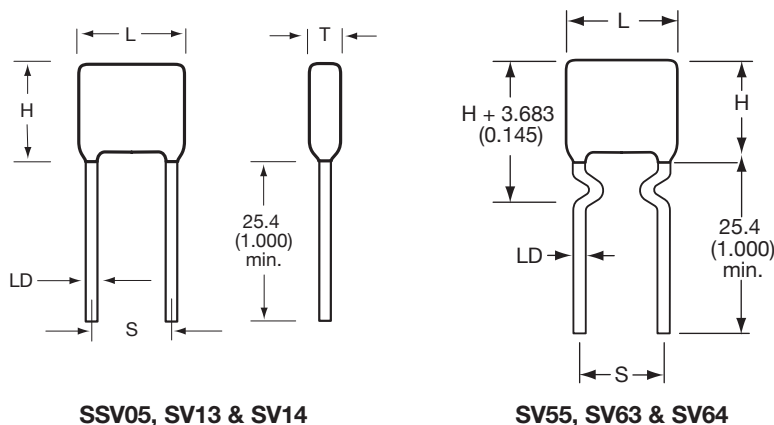

Not RoHS Compliant



For RoHS compliant products, please select correct termination style.

AUTOMOTIVE GRADE HIGH VOLTAGE MLC RADIALS

HOW TO ORDER

AVX Styles: SV05, SV13 & SV14

SV01
AVX Style

A
Voltage
1000V = A

A
Temperature Coefficient
COG = A

153
Capacitance Code
(2 significant digits + no. of zeros)
Examples:
1.000 pF = 102
22.000 pF = 223

K
Capacitance Tolerance
J = ±5%
K = ±10%
M = ±20%

4
Test Level
4 = AEC-Q200

A
Leads
A = Tin/Lead
R = R o H S
Compliant*

Packaging
(See Note 1)

Note 1: No suffix signifies bulk packaging which is AVX standard packaging. Use suffix "TR1" if tape and reel is required. Parts are reel packaged per EIA-468.

Note: Capacitors with X7R dielectrics are not intended for applications across AC supply mains or AC line filtering with polarity reversal. Contact plant for recommendations.

*Hi-Rel screening consists of 100% Group A, Subgroup 1 per MIL-PRF-49467. (Except partial discharge testing is not performed and DWV is at 120% rated voltage).

DIMENSIONS

millimeters (inches)

AVX Style	Length (L) max	Height (H) max	Thickness (T) max	Lead Spacing ±.762 (.030) (S)	LD (Nom)
SV05/SV55	11.9 (0.470)	10.2 (0.400)	5.08 (0.200)	9.52 (0.375)	0.64 (0.025)
SV13/SV63	7.62 (0.300)	9.14 (0.360)	5.08 (0.200)	5.08 (0.200)	0.51 (0.020)
SV14/SV64	10.2 (0.400)	11.7 (0.460)	5.08 (0.200)	5.08 (0.200)	0.51 (0.020)

TAPE & REEL QUANTITY	
Part	Pieces
SV05/SV55	1000
SV13/SV63	1000
SV14/SV64	1000

CAPACITANCE VALUE

COG	
Style	1000V min./max.
SV05/SV55	1000 pF / 0.015 μF
SV13/SV63	1000 pF / 8200 pF
SV14/SV64	1000 pF / 0.015 μF

MLC Chip Capacitors

Basic Construction

A multilayer ceramic (MLC) capacitor is a monolithic block of ceramic containing two sets of offset, interleaved planar electrodes that extend to two opposite surfaces of the ceramic dielectric. This simple structure requires a considerable amount of sophistication,

both in material and in manufacture, to produce it in the quality and quantities needed in today's electronic equipment.

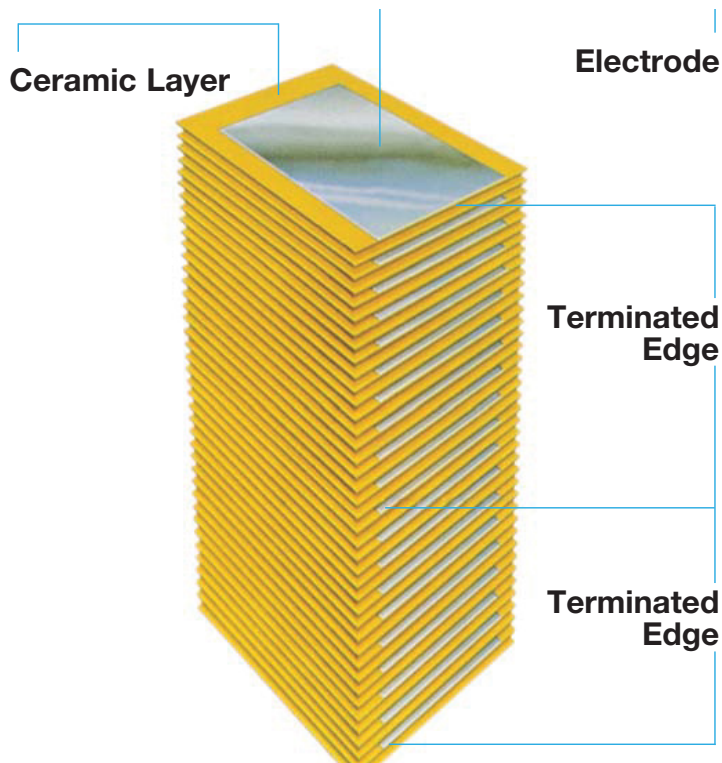

Terminations

- Standard Nickel Barrier
 - Lead Free Tin Plate (RoHS Compliant)
 - 5% minimum Lead Plated
- Leach resistance to 90 seconds at 260°C
- Solderable plated for dimensional control
- Special materials as required

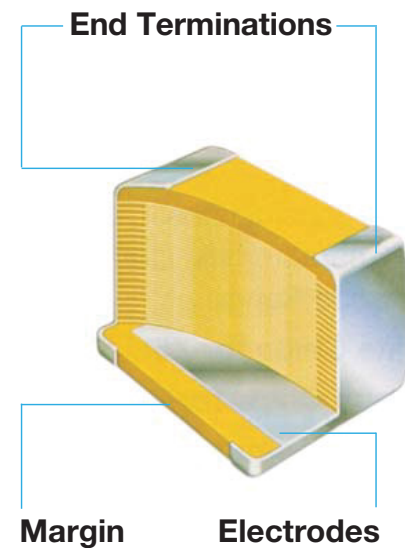

QUALITY STATEMENT

AVX focus is customer satisfaction – Customer satisfaction in the broadest sense: Products, service, price, delivery, technical support, and all the aspects of a business that impact you, the customer.

Our long term strategy is for continuous improvement which is defined by our Quality Vision 2000. This is a total quality management system developed by and supported by AVX corporate management. The foundation of QV2000 is built upon military and commercial standards and systems including ISO9001. QV2000 is a

natural extension of past quality efforts with world class techniques for ensuring a total quality environment to satisfy our customers during this decade and into the 21st century.

As your components supplier, we invite you to experience the quality, service, and commitment of AVX.

MLC Chip Capacitors

General Description

Table 1: EIA and MIL Temperature Stable and General Application Codes

EIA CODE	
Percent Capacity Change Over Temperature Range	
RS198	Temperature Range
X7	-55°C to +125°C
X5	-55°C to +85°C
Y5	-30°C to +85°C
Z5	+10°C to +85°C
Code	Percent Capacity Change
D	±3.3%
E	±4.7%
F	±7.5%
P	±10%
R	±15%
S	±22%
T	+22%, -33%
U	+22%, -56%
V	+22%, -82%

EXAMPLE - A capacitor is desired with the capacitance value at 25°C to increase no more than 7.5% or decrease no more than 7.5% from -30°C to +85°C. EIA Code will be Y5F.

MIL CODE		
Symbol	Temperature Range	
A	-55°C to +85°C	
B	-55°C to +125°C	
C	-55°C to +150°C	
Symbol	Cap. Change Zero Volts	Cap. Change Rated Volts
Q	+15%, -15%	+15%, -50%
R	+15%, -15%	+15%, -40%
W	+22%, -56%	+22%, -66%
X	+15%, -15%	+15%, -25%
Y	+30%, -70%	+30%, -80%
Z	+20%, -20%	+20%, -30%

Temperature characteristic is specified by combining range and change symbols, for example BR or AW. Specification slash sheets indicate the characteristic applicable to a given style of capacitor.

In specifying capacitance change with temperature for Class 2 materials, EIA expresses the capacitance change over an operating temperature range by a 3 symbol code.

The first symbol represents the cold temperature end of the temperature range, the second represents the upper limit of the operating temperature range and the third symbol represents the capacitance change allowed over the operating temperature range. Table 1 provides a detailed explanation of the EIA system.

Effects of Voltage – Variations in voltage have little effect on Class 1 dielectric but does affect the capacitance and dissipation factor of Class 2 dielectrics. The application of DC voltage reduces both the capacitance and dissipation factor while the application of an AC voltage within a reasonable range tends to increase both capacitance and dissipation factor readings. If a high enough AC voltage is applied, eventually it will reduce capacitance just as a DC voltage will. Figure 2 shows the effects of AC voltage.

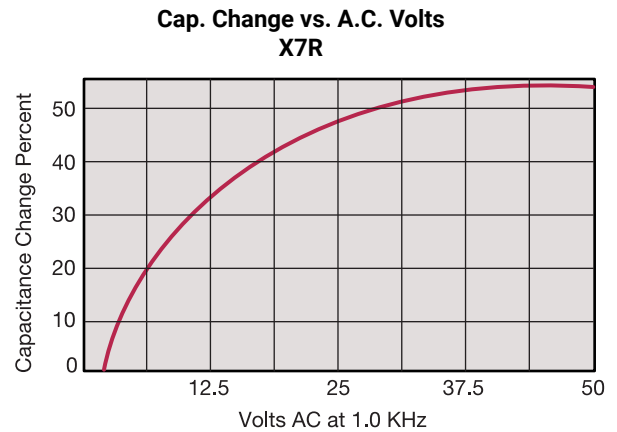

Figure 2

Capacitor specifications specify the AC voltage at which to measure (normally 0.5 or 1 VAC) and application of the wrong voltage can cause spurious readings.

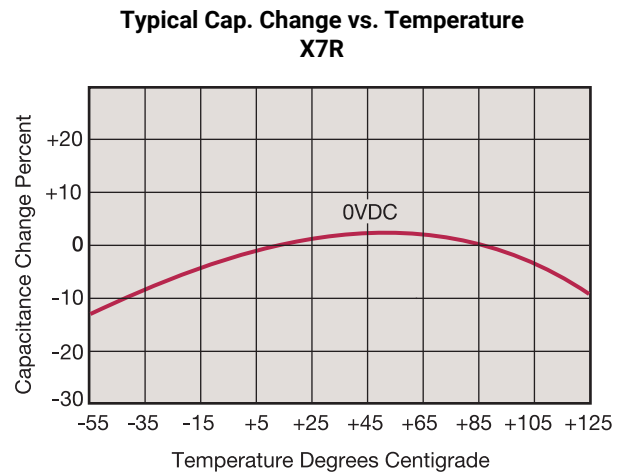

Figure 3

MLC Chip Capacitors

General Description

Effects of Time – Class 2 ceramic capacitors change capacitance and dissipation factor with time as well as temperature, voltage and frequency. This change with time is known as aging. Aging is caused by a gradual re-alignment of the crystalline structure of the ceramic and produces an exponential loss in capacitance and decrease in dissipation factor versus time. A typical curve of aging rate for semistable ceramics is shown in Figure 4.

If a Class 2 ceramic capacitor that has been sitting on the shelf for a period of time, is heated above its curie point, (125°C for 4 hours or 150°C for 1/2 hour will suffice) the part will de-age and return to its initial capacitance and dissipation factor readings. Because the capacitance changes rapidly, immediately after de-aging, the basic capacitance measurements are normally referred to a time period sometime after the de-aging process. Various manufacturers use different time bases but the most popular one is one day or twenty-four hours after “last heat.” Change in the aging curve can be caused by the application of voltage and other stresses. The possible changes in capacitance due to de-aging by heating the unit explain why capacitance changes are allowed after test, such as temperature cycling, moisture resistance, etc., in MIL specs. The application of high voltages such as dielectric withstanding voltages also tends to de-age capacitors and is why re-reading of capacitance after 12 or 24 hours is allowed in military specifications after dielectric strength tests have been performed.

Effects of Frequency – Frequency affects capacitance and impedance characteristics of capacitors. This effect is much more pronounced in high dielectric constant ceramic formulation than in low K formulations. AVX’s SpiCalci software generates impedance, ESR, series inductance, series resonant frequency and capacitance all as functions of frequency, temperature and DC bias for standard chip sizes and styles. It is available free from AVX and can be downloaded for free from AVX website: <http://www.avx.com/download/software/SpiCalci-AVX.zip>.



**Typical Curve of Aging Rate
X7R**

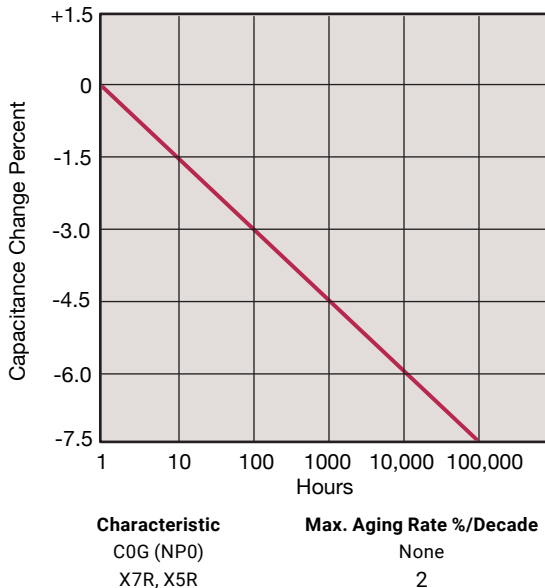

Figure 4

Effects of Mechanical Stress – High “K” dielectric ceramic capacitors exhibit some low level piezoelectric reactions under mechanical stress. As a general statement, the piezoelectric output is higher, the higher the dielectric constant of the ceramic. It is desirable to investigate this effect before using high “K” dielectrics as coupling capacitors in extremely low level applications.

Reliability – Historically ceramic capacitors have been one of the most reliable types of capacitors in use today. The approximate formula for the reliability of a ceramic capacitor is:

$$\frac{L_o}{L_t} = \left(\frac{V_t}{V_o}\right)^x \left(\frac{T_t}{T_o}\right)^y$$

where

L_o = operating life

L_t = test life

V_t = test voltage

V_o = operating voltage

T_t = test temperature and

T_o = operating temperature in °C

X, Y = see text

Historically for ceramic capacitors exponent X has been considered as 3. The exponent Y for temperature effects typically tends to run about 8.

MLC Chip Capacitors

General Description

A capacitor is a component which is capable of storing electrical energy. It consists of two conductive plates (electrodes) separated by insulating material which is called the dielectric. A typical formula for determining capacitance is:

C = capacitance (picofarads)

$$C = \frac{.224 KA}{t}$$

K = dielectric constant (Vacuum = 1)

A = area in square inches

t = separation between the plates in inches (thickness of dielectric)

.224 = conversion constant (.0884 for metric system in cm)

Capacitance – The standard unit of capacitance is the farad. A capacitor has a capacitance of 1 farad when 1 coulomb charges it to 1 volt. One farad is a very large unit and most capacitors have values in the micro (10^{-6}), nano (10^{-9}) or pico (10^{-12}) farad level.

Dielectric Constant – In the formula for capacitance given above the dielectric constant of a vacuum is arbitrarily chosen as the number 1. Dielectric constants of other materials are then compared to the dielectric constant of a vacuum.

Dielectric Thickness – Capacitance is indirectly proportional to the separation between electrodes. Lower voltage requirements mean thinner dielectrics and greater capacitance per volume.

Area – Capacitance is directly proportional to the area of the electrodes. Since the other variables in the equation are usually set by the performance desired, area is the easiest parameter to modify to obtain a specific capacitance within a material group.

Energy Stored – The energy which can be stored in a capacitor is given by the formula:

E = energy in joules (watts-sec)

V = applied voltage

C = capacitance in farads

Potential Change – A capacitor is a reactive component which

$$E = \frac{1}{2}CV^2$$

reacts against a change in potential across it. This is shown by the equation for the linear charge of a capacitor:

where

I = Current

C = Capacitance

dV/dt = Slope of voltage transition across capacitor

$$I_{ideal} = C \frac{dV}{dt}$$

Thus an infinite current would be required to instantly change the potential across a capacitor. The amount of current a capacitor can “sink” is determined by the above equation.

Equivalent Circuit – A capacitor, as a practical device, exhibits not only capacitance but also resistance and inductance. A simplified schematic for the equivalent circuit is:

C = Capacitance

L = Inductance

R_s = Series Resistance

R_p = Parallel Resistance

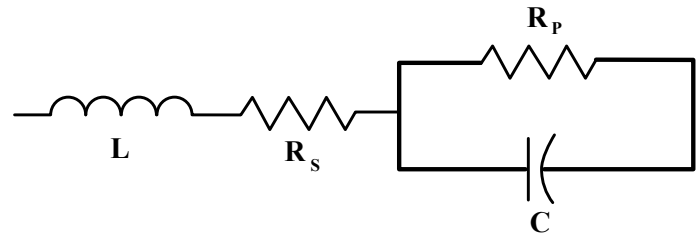

Reactance – Since the insulation resistance (Rp) is normally very high, the total impedance of a capacitor is:

$$Z = \sqrt{R_s^2 + (X_c - X_L)^2}$$

where

Z = Total Impedance

R_s = Series Resistance

X_c = Capacitive Reactance = $\frac{1}{2\pi fC}$

X_L = Inductive Reactance = $2\pi fL$

The variation of a capacitor's impedance with frequency determines its effectiveness in many applications.

Phase Angle – Power Factor and Dissipation Factor are often confused since they are both measures of the loss in a capacitor under AC application and are often almost identical in value. In a “perfect” capacitor the current in the capacitor will lead the voltage by 90°.

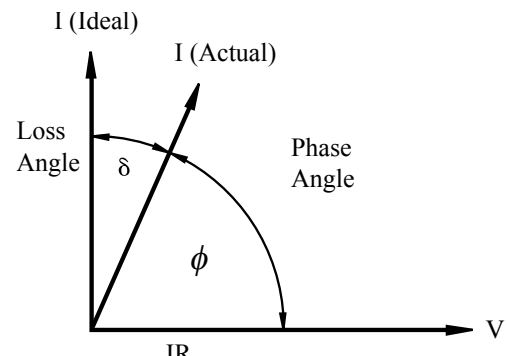

In practice the current leads the voltage by some other phase angle due to the series resistance R_s. The complement of this angle is called the loss angle and:

Power Factor (P.F.) = Cos φ or Sine δ

Dissipation Factor (D.F.) = tan δ

for small values of δ the tan and sine are essentially equal which has led to the common interchangeability of the two terms in the industry.

MLC Chip Capacitors

General Description

Equivalent Series Resistance – The term E.S.R. or Equivalent Series Resistance combines all losses both series and parallel in a capacitor at a given frequency so that the equivalent circuit is reduced to a simple R-C series connection.

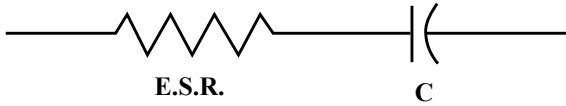

Dissipation Factor – The DF/PF of a capacitor tells what percent of the apparent power input will turn to heat in the capacitor.

$$\text{Dissipation Factor} = \frac{\text{E.S.R.}}{X_c} = (2 \pi fC) (\text{E.S.R.})$$

The watts loss are:

$$\text{Watts loss} = (2 \pi fC V^2) (\text{D.F.})$$

Very low values of dissipation factor are expressed as their reciprocal for convenience. These are called the "Q" or Quality factor of capacitors.

Parasitic Inductance – The parasitic inductance of capacitors is becoming more and more important in the decoupling of today's high speed digital systems. The relationship between the inductance and the ripple voltage induced on the DC voltage line can be seen from the simple inductance equation:

$$V = L \frac{di}{dt}$$

The $\frac{di}{dt}$ seen in current microprocessors can be as high as 0.3 A/ns, and up to 10A/ns. At 0.3 A/ns, 100pH of parasitic inductance can cause a voltage spike of 30mV. While this does not sound very drastic, with the Vcc for microprocessors decreasing at the current rate, this can be a fairly large percentage.

Another important, often overlooked, reason for knowing the parasitic inductance is the calculation of the resonant frequency. This can be important for high frequency, by-pass capacitors, as the resonant point will give the most signal attenuation. The resonant frequency f_{res} is calculated from the simple equation:

$$2\pi\sqrt{LC}$$

Insulation Resistance – Insulation Resistance is the resistance measured across the terminals of a capacitor and consists principally of the parallel resistance RP shown in the equivalent circuit. As capacitance values and hence the area of dielectric increases, the I.R. decreases and hence the product (C x IR or RC) is often specified in ohm farads or more commonly megohm-microfarads. Leakage current is determined by dividing the rated voltage by IR (Ohm's Law).

Dielectric Strength – Dielectric Strength is an expression of the ability of a material to withstand an electrical stress. Although dielectric strength is ordinarily expressed in volts, it is actually dependent on the thickness of the dielectric and thus is also more generically a function of volts/mil.

Dielectric Absorption – A capacitor does not discharge instantaneously upon application of a short circuit, but drains gradually after the capacitance proper has been discharged. It is common practice to measure the dielectric absorption by determining the "reappearing voltage" which appears across a capacitor at some point in time after it has been fully discharged under short circuit conditions.

Corona – Corona is the ionization of air or other vapors which causes them to conduct current. It is especially prevalent in high voltage units but can occur with low voltages as well where high voltage gradients occur. The energy discharged degrades the performance of the capacitor and can in time cause catastrophic failures.

REFLOW SOLDERING

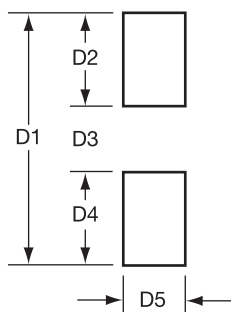

Dimensions in millimeters (inches)

Case Size	D1	D2	D3	D4	D5
0805 (LD05)	3.00 (0.120)	1.00 (0.040)	1.00 (0.040)	1.00 (0.040)	1.25 (0.050)
1206 (LD06)	4.00 (0.160)	1.00 (0.040)	2.00 (0.090)	1.00 (0.040)	1.60 (0.060)
*1210 (LD10)	4.00 (0.160)	1.00 (0.040)	2.00 (0.090)	1.00 (0.040)	2.50 (0.100)
*1808 (LD08)	5.60 (0.220)	1.00 (0.040)	3.60 (0.140)	1.00 (0.040)	2.00 (0.080)
*1812 (LD12)	5.60 (0.220)	1.00 (0.040)	3.60 (0.140)	1.00 (0.040)	3.00 (0.120)
*1825 (LD13)	5.60 (0.220)	1.00 (0.040)	3.60 (0.140)	1.00 (0.040)	6.35 (0.250)
*2220 (LD20)	6.60 (0.260)	1.00 (0.040)	4.60 (0.180)	1.00 (0.040)	5.00 (0.200)
*2225 (LD14)	6.60 (0.260)	1.00 (0.040)	4.60 (0.180)	1.00 (0.040)	6.35 (0.250)
*HQCC	6.60 (0.260)	1.00 (0.040)	4.60 (0.180)	1.00 (0.040)	6.35 (0.250)
*3640 (LD40)	10.67 (0.427)	1.52 (0.060)	7.62 (0.300)	1.52 (0.060)	10.16 (0.400)
*HQCE	10.67 (0.427)	1.52 (0.060)	7.62 (0.300)	1.52 (0.060)	10.16 (0.400)

millimeters (inches)

*AVX recommends reflow soldering only.

Component Pad Design

Component pads should be designed to achieve good solder fillets and minimize component movement during reflow soldering. Pad designs are given below for the most common sizes of multilayer ceramic capacitors for both wave and reflow soldering. The basis of these designs is:

- Pad width equal to component width. It is permissible to decrease this to as low as 85% of component width but it is not advisable to go below this.
- Pad overlap 0.5mm beneath component.
- Pad extension 0.5mm beyond components for reflow and 1.0mm for wave soldering.

WAVE SOLDERING

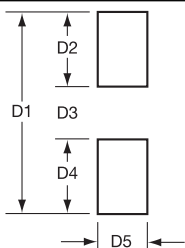

Case Size	D1	D2	D3	D4	D5
0805	4.00 (0.15)	1.50 (0.06)	1.00 (0.04)	1.50 (0.06)	1.25 (0.05)
1206	5.00 (0.19)	1.50 (0.06)	2.00 (0.09)	1.50 (0.06)	1.60 (0.06)

Dimensions in millimeters (inches)

Component Spacing

For wave soldering components, must be spaced sufficiently far apart to avoid bridging or shadowing (inability of solder to penetrate properly into small spaces). This is less important for reflow soldering but sufficient space must be allowed to enable rework should it be required.

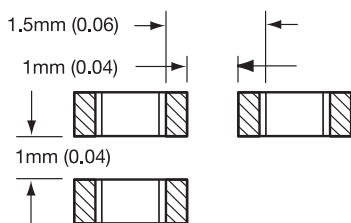

this differential should not exceed 100°C.

For further specific application or process advice, please consult AVX.

Cleaning

Care should be taken to ensure that the capacitors are thoroughly cleaned of flux residues especially the space beneath the capacitor. Such residues may otherwise become conductive and effectively offer a low resistance bypass to the capacitor.

Ultrasonic cleaning is permissible, the recommended conditions being 8 Watts/litre at 20-45 kHz, with a process cycle of 2 minutes vapor rinse, 2 minutes immersion in the ultrasonic solvent bath and finally 2 minutes vapor rinse.

Preheat & Soldering

The rate of preheat should not exceed 4°C/second to prevent thermal shock. A better maximum figure is about 2°C/second. For capacitors size 1206 and below, with a maximum thickness of 1.25mm, it is generally permissible to allow a temperature differential from preheat to soldering of 150°C. In all other cases

REFLOW SOLDER PROFILES

AVX RoHS compliant products utilize termination finishes (e.g. Sn or SnAg) that are compatible with all Pb-Free soldering systems and are fully reverse compatible with SnPb soldering systems. A recommended SnPb profile is shown for comparison; for Pb-Free soldering, IPC/JEDECJ-STD-020C may be referenced. The upper line in the chart shows the maximum envelope to which products are qualified (typically 3x reflow cycles at 260°C max). The center line gives the recommended profile for optimum wettability and soldering in Pb-Free Systems.

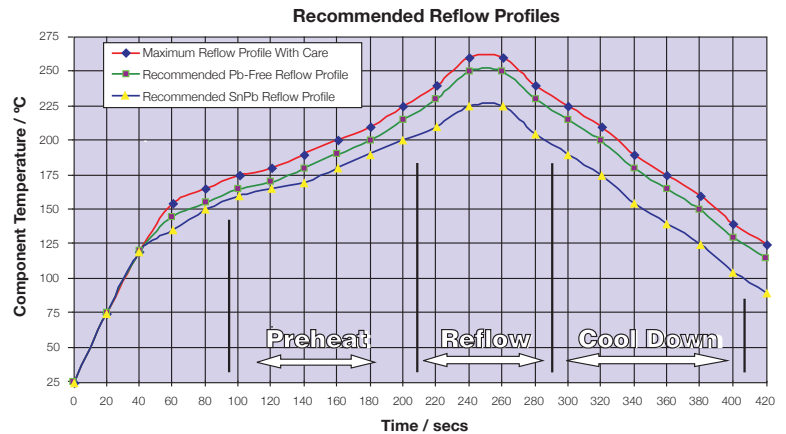

Preheat:

The pre-heat stabilizes the part and reduces the temperature differential prior to reflow. The initial ramp to 125°C may be rapid, but from that point (2-3)°C/sec is recommended to allow ceramic parts to heat uniformly and plastic encapsulated parts to stabilize through the glass transition temperature of the body (~ 180°C).

Reflow:

In the reflow phase, the maximum recommended time > 230°C is 40secs. Time at peak reflow is 10secs max.; optimum reflow is achieved at 250°C, (see wetting balance chart opposite) but products are qualified to 260°C max. Please reference individual product datasheets for maximum limits

Cool Down:

Cool down should not be forced and 6°C/sec is recommended. A slow cool down will result in a finer grain structure of the reflow solder in the solder fillet.



IMPORTANT NOTE: Typical Pb-Free reflow solders have a more dull and grainy appearance compared to traditional SnPb. Elevating the reflow temperature will not change this, but extending the cool down can help improve the visual appearance of the joint.

WAVE SOLDER PROFILES

For wave solder, there is no change in the recommended wave profile; all standard Pb-Free (SnCu/SnCuAg) systems operate at the same 260°C max recommended for SnPb systems.

Preheat:

This is more important for wave solder; a higher temperature preheat will reduce the thermal shock to SMD parts that are immersed (please consult individual product data sheets for SMD parts that are suited to wave solder). SMD parts should ideally be heated from the bottom-Side prior to wave. PTH (Pin through hole) parts on the topside should not be separately heated.

Wave:

250°C – 260°C recommended for optimum solderability.

Cool Down:

As with reflow solder, cool down should not be forced and 6°C/sec is recommended. Any air knives at the end of the 2nd wave should be heated.

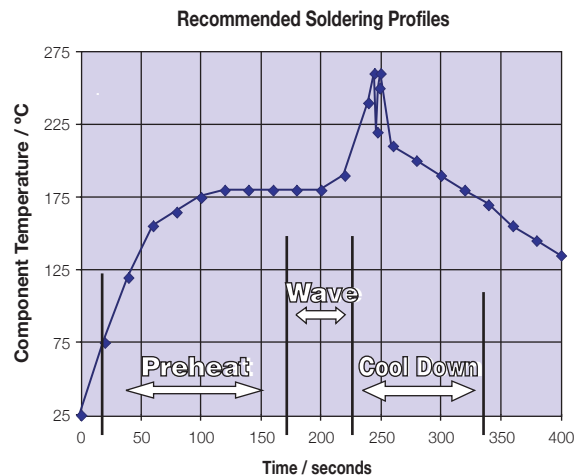

MLC Chip Capacitors

Surface Mounting Guide

APPLICATION NOTES

Storage

Good solderability is maintained for at least twelve months, provided the components are stored in their "as received" packaging at less than 40°C and 70% RH.

Solderability

Terminations to be well soldered after immersion in a 60/40 tin/lead solder bath at 235 ± 5°C for 2 ± 1 seconds.

Leaching

Terminations will resist leaching for at least the immersion times and conditions shown below.

Termination Type	Solder Tin/Lead/Silver	Solder Temp. °C	Immersion Time Seconds
Nickel Barrier	60/40/0	260 ± 5	30 ± 1

Recommended Soldering Profiles

Reflow

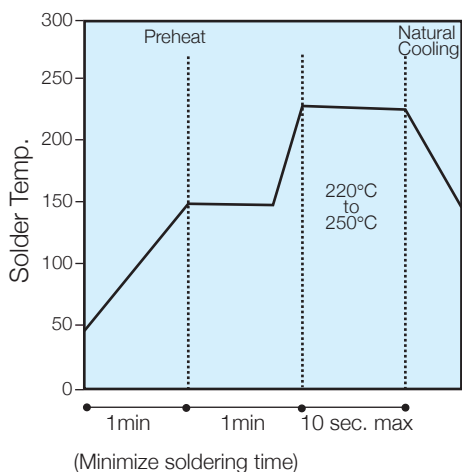

Lead-Free Reflow Profile

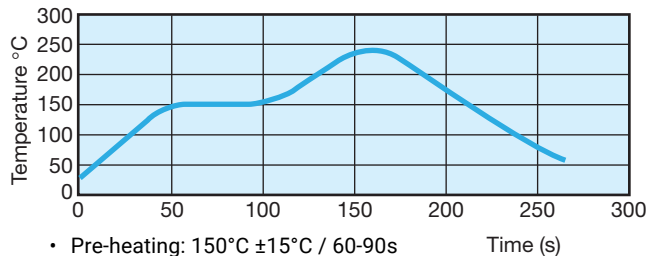

- Pre-heating: 150°C ±15°C / 60-90s
- Max. Peak Gradient 2.5°C/s
- Peak Temperature: 245°C ±5°C
- Time at >230°C: 40s Max.

Wave

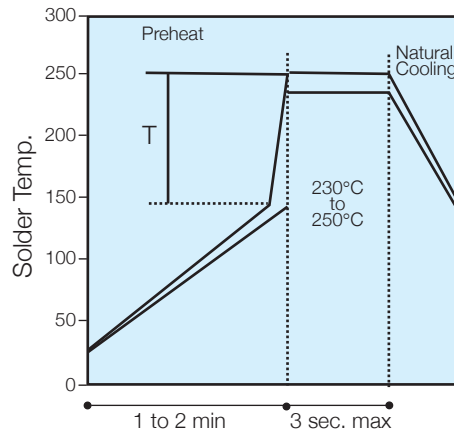

(Preheat chips before soldering)
T/maximum 150°C

Lead-Free Wave Soldering

The recommended peak temperature for lead-free wave soldering is 250°C-260°C for 3-5 seconds. The other parameters of the profile remains the same as above.

The following should be noted by customers changing from lead based systems to the new lead free pastes.

- The visual standards used for evaluation of solder joints will need to be modified as lead free joints are not as bright as with tin-lead pastes and the fillet may not be as large.
- Resin color may darken slightly due to the increase in temperature required for the new pastes.
- Lead-free solder pastes do not allow the same self alignment as lead containing systems. Standard mounting pads are acceptable, but machine set up may need to be modified.

General

Surface mounting chip multilayer ceramic capacitors are designed for soldering to printed circuit boards or other substrates. The construction of the components is such that they will withstand the time/temperature profiles used in both wave and reflow soldering methods.

Handling

Chip multilayer ceramic capacitors should be handled with care to avoid damage or contamination from perspiration and skin oils. The use of tweezers or vacuum pick ups is strongly recommended for individual components. Bulk handling should ensure that abrasion and mechanical shock are minimized. Taped and reeled components provides the ideal medium for direct presentation to the placement machine. Any mechanical shock should be minimized during handling chip multilayer ceramic capacitors.

Preheat

It is important to avoid the possibility of thermal shock during soldering and carefully controlled preheat is therefore required. The rate of preheat should not exceed 4°C/second and a target figure 2°C/second is recommended. Although an 80°C to 120°C temperature differential is preferred, recent developments allow a temperature differential between the component surface and the

MLC Chip Capacitors

Surface Mounting Guide

soldering temperature of 150°C (Maximum) for capacitors of 1210 size and below with a maximum thickness of 1.25mm. The user is cautioned that the risk of thermal shock increases as chip size or temperature differential increases.

Soldering

Mildly activated rosin fluxes are preferred. The minimum amount of solder to give a good joint should be used. Excessive solder can lead to damage from the stresses caused by the difference in coefficients of expansion between solder, chip and substrate. AVX terminations are suitable for all wave and reflow soldering systems. If hand soldering cannot be avoided, the preferred technique is the utilization of hot air soldering tools.

Cooling

Natural cooling in air is preferred, as this minimizes stresses within the soldered joint. When forced air cooling is used, cooling rate should not exceed 4°C/second. Quenching is not recommended but if used, maximum temperature differentials should be observed according to the preheat conditions above.

Cleaning

Flux residues may be hygroscopic or acidic and must be removed. AVX MLC capacitors are acceptable for use with all of the solvents described in the specifications MIL-STD-202 and EIA-RS-198. Alcohol based solvents are acceptable and properly controlled water cleaning systems are also acceptable. Many other solvents have been proven successful, and most solvents that are acceptable to other components on circuit assemblies are equally acceptable for use with ceramic capacitors.

POST SOLDER HANDLING

Once SMP components are soldered to the board, any bending or flexure of the PCB applies stresses to the soldered joints of the components. For leaded devices, the stresses are absorbed by the compliancy of the metal leads and generally don't result in problems unless the stress is large enough to fracture the soldered connection.

Ceramic capacitors are more susceptible to such stress because they don't have compliant leads and are brittle in nature. The most frequent failure mode is low DC resistance or short circuit. The second failure mode is significant loss of capacitance due to severing of contact between sets of the internal electrodes.

Cracks caused by mechanical flexure are very easily identified and generally take one of the following two general forms:



Type A:

Angled crack between bottom of device to top of solder joint.

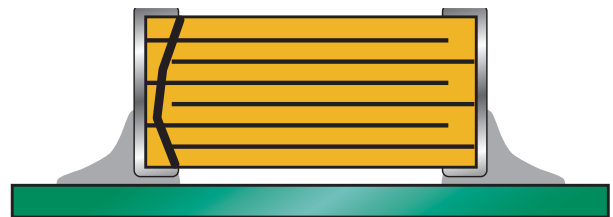

Type B:

Fracture from top of device to bottom of device.

Mechanical cracks are often hidden underneath the termination and are difficult to see externally. However, if one end termination falls off during the removal process from PCB, this is one indication that the cause of failure was excessive mechanical stress due to board warping.

MLC Chip Capacitors

Surface Mounting Guide

COMMON CAUSES OF MECHANICAL CRACKING

The most common source for mechanical stress is board depanelization equipment, such as manual breakapart, v-cutters and shear presses. Improperly aligned or dull cutters may cause torqueing of the PCB resulting in flex stresses being transmitted to components near the board edge. Another common source of flexural stress is contact during parametric testing when test points are probed. If the PCB is allowed to flex during the test cycle, nearby ceramic capacitors may be broken.

A third common source is board to board connections at vertical connectors where cables or other PCBs are connected to the PCB. If the board is not supported during the plug/unplug cycle, it may flex and cause damage to nearby components.

Special care should also be taken when handling large (>6" on a side) PCBs since they more easily flex or warp than smaller boards.

REWORKING OF MLCs

Thermal shock is common in MLCs that are manually attached or reworked with a soldering iron. AVX strongly recommends that any reworking of MLCs be done with hot air reflow rather than soldering irons. It is practically impossible to cause any thermal shock in ceramic capacitors when using hot air reflow.

However direct contact by the soldering iron tip often causes thermal cracks that may fail at a later date. If rework by soldering iron is absolutely necessary, it is recommended that the wattage of the iron be less than 30 watts and the tip temperature be <300°C. Rework should be performed by applying the solder iron tip to the pad and not directly contacting any part of the ceramic capacitor.

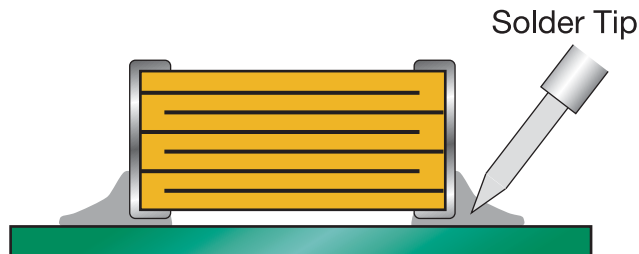

Preferred Method - No Direct Part Contact

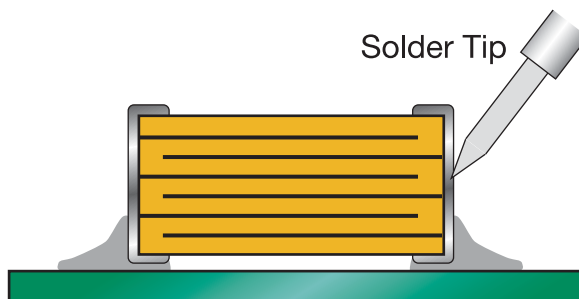

Poor Method - Direct Contact with Part

PCB BOARD DESIGN

To avoid many of the handling problems, AVX recommends that MLCs be located at least .2" away from nearest edge of board. However when this is not possible, AVX recommends that the panel be routed along the cut line, adjacent to where the MLC is located.

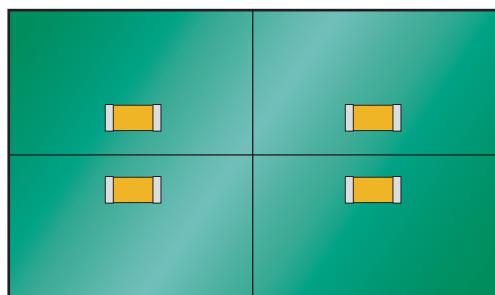

No Stress Relief for MLCs

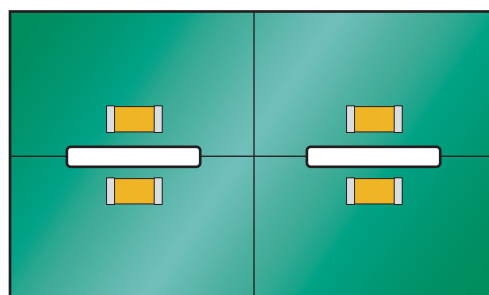

Routed Cut Line Relieves Stress on MLC

MLC Chip Capacitors

MIL-PRF-123/Chips

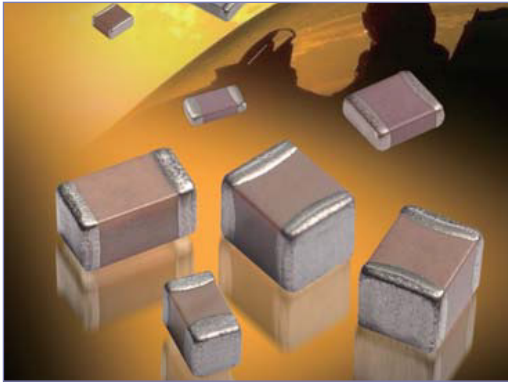

AVX's M123 series MIL-qualified ceramic capacitors are designed for high performance application in BX voltage temperature characteristics for general purpose dielectric and in BP voltage temperature characteristics for temperature stable dielectric.

M123 series capacitors offer design and component engineers a proven technology for SMD processing and applications requiring space-level reliability. They are designed for use in timing circuits and critical frequency applications where absolute stability of capacitance is required (BP), as well as in applications where a wider capacitance variation with temperature and voltage can be tolerated (BX)

HOW TO ORDER

Military Type Designation: Capacitors, Fixed, Ceramic Dielectric, (Temperature Stable and General Purpose), High Reliability

Not RoHS Compliant

M123

Mil-Spec Number

A

Modification Spec.

10

Slash Sheet Number

BX

Temperature Characteristic

B

Voltage
B = 50V
C = 100V

103

Capacitance Code

K

Capacitance Tolerance

C = ±0.25pF
D = ±0.5pF
F = ±1%
J = ±5%
K = ±10%
M = ±20%

S

Termination

G = Silver - Nickel - Gold
M = Palladium/Silver
S = Silver - Nickel - Solder Coated
Z = Silver - Nickel - Solder Plated (tin/lead alloy with a minimum of 4 percent lead)

Capacitance change with reference to 25°C over temperature range -55°C to +125°C

Symbol	Without Voltage	With Rated DC Voltage
BP	0 ± 30 ppm/°C	0 ± 30 ppm/°C
BX	+15, -15%	+15, -25%

DIMENSIONS

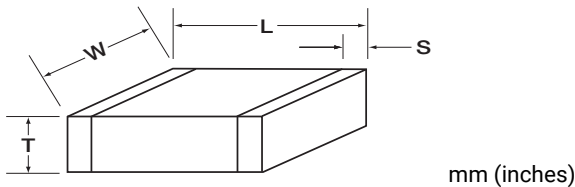

(L) Length	(W) Width	(T) Thickness	(S) Termination Band
CKS51, /10, 0805 Size Chip			
2.03 (0.080)	1.27 (0.050)	0.508 (0.020) Min.	0.508 (0.020)
± 0.381 (0.015)	± 0.381 (0.015)	1.40 (0.055) Max.	± 0.254 (0.010)
CKS52, /11, 1210 Size Chip			
3.05 (0.120)	2.54 (0.100)	0.508 (0.020) Min.	0.508 (0.020)
± 0.381 (0.015)	± 0.381 (0.015)	1.65 (0.065) Max.	± 0.254 (0.010)
CKS53, /12, 1808 Size Chip			
4.57 (0.180)	2.03 (0.080)	0.508 (0.020) Min.	0.508 (0.020)
± 0.381 (0.015)	± 0.381 (0.015)	1.65 (0.065) Max.	± 0.254 (0.010)
CKS54, /13, 2225 Size Chip			
5.59 (0.220)	6.35 (0.250)	0.508 (0.020) Min.	0.508 (0.020)
± 0.381 (0.015)	± 0.381 (0.015)	1.78 (0.070) Max.	± 0.254 (0.010)
CKS55, /21, 1206 Size Chip			
3.05 (0.120)	1.52 (0.060)	0.508 (0.020) Min.	0.508 (0.020)
± 0.381 (0.015)	± 0.381 (0.015)	1.65 (0.065) Max.	± 0.254 (0.010)
CKS56, /22, 1812 Size Chip			
4.57 (0.180)	3.18 (0.125)	0.508 (0.020) Min.	0.508 (0.020)
± 0.381 (0.015)	± 0.381 (0.015)	2.03 (0.080) Max.	± 0.254 (0.010)
CKS57, /23, 1825 Size Chip			
4.57 (0.180)	6.35 (0.250)	0.508 (0.020) Min.	0.508 (0.020)
± 0.381 (0.015)	± 0.381 (0.015)	2.03 (0.080) Max.	± 0.254 (0.010)

Slash Sheet	Case Size	Dielectric	Cap Range (pF)
10	0805	BP	1.0-680
		BX	330-18,000
11	1210	BP	300-3,300
		BX	5,600-100,000
12	1808	BP	300-1,000
		BX	5,600-100,000
13	2225	BP	1,100-10,000
		BX	120,000-1,000,000
21	1206	BP	1.0-2,200
		BX	4,700-39,000
22	1812	BP	1,200-10,000
		BX	27,000-180,000
23	1825	BP	3,900-22,000
		BX	56,000-470,000

Performance of SMPS capacitors can be simulated by downloading SpiCalci software program - <http://www.avx.com/download/software/SpiCalci-AVX.zip>



The Important Information/Disclaimer is incorporated in the catalog where these specifications came from or available online at www.avx.com/disclaimer/ by reference and should be reviewed in full before placing any order.

MIL-PRF-123/STYLE CKS51, -/10

Part Number 1/ (0805 Size Chip)	Capacitance pF	Capacitance Tolerance	Voltage-Temperature Limits	Rated Voltage
M123A10BP_1R0	1.0	C,D	BP	50,100
M123A10BP_1R1	1.1	↓	↓	↓
M123A10BP_1R2	1.2	↓	↓	↓
M123A10BP_1R3	1.3	↓	↓	↓
M123A10BP_1R5	1.5	↓	↓	↓
M123A10BP_1R6	1.6	↓	↓	↓
M123A10BP_1R8	1.8	↓	↓	↓
M123A10BP_2R0	2.0	↓	↓	↓
M123A10BP_2R2	2.2	↓	↓	↓
M123A10BP_2R4	2.4	↓	↓	↓
M123A10BP_2R7	2.7	↓	↓	↓
M123A10BP_3R0	3.0	↓	↓	↓
M123A10BP_3R3	3.3	↓	↓	↓
M123A10BP_3R6	3.6	↓	↓	↓
M123A10BP_3R9	3.9	↓	↓	↓
M123A10BP_4R3	4.3	↓	↓	↓
M123A10BP_4R7	4.7	↓	↓	↓
M123A10BP_5R1	5.1	↓	↓	↓
M123A10BP_5R6	5.6	↓	↓	↓
M123A10BP_6R2	6.2	↓	↓	↓
M123A10BP_6R8	6.8	↓	↓	↓
M123A10BP_7R5	7.5	↓	↓	↓
M123A10BP_8R2	8.2	↓	↓	↓
M123A10BP_9R1	9.1	↓	↓	↓
M123A10BP_100	10	C, J, K	↓	↓
M123A10BP_110	11	↓	↓	↓
M123A10BP_120	12	↓	↓	↓
M123A10BP_130	13	↓	↓	↓
M123A10BP_150	15	↓	↓	↓
M123A10BP_160	16	↓	↓	↓
M123A10BP_180	18	↓	↓	↓
M123A10BP_200	20	↓	↓	↓
M123A10BP_220	22	↓	↓	↓
M123A10BP_240	24	F, J, K	↓	↓
M123A10BP_270	27	↓	↓	↓
M123A10BP_300	30	↓	↓	↓
M123A10BP_330	33	↓	↓	↓
M123A10BP_360	36	↓	↓	↓
M123A10BP_390	39	↓	↓	↓
M123A10BP_430	43	↓	↓	↓
M123A10BP_470	47	↓	↓	↓
M123A10BP_510	51	↓	↓	↓
M123A10BP_560	56	↓	↓	↓
M123A10BP_620	62	↓	↓	↓
M123A10BP_680	68	↓	↓	↓
M123A10BP_750	75	F, J, K	BP	50,100

Part Number 1/ (0805 Size Chip)	Capacitance pF	Capacitance Tolerance	Voltage-Temperature Limits	Rated Voltage
M123A10BP_820_	82	F, J, K	BP	50,100
M123A10BP_910_	91	↓	↓	↓
M123A10BP_101_	100	↓	↓	↓
M123A10BP_111_	110	↓	↓	↓
M123A10BP_121_	120	↓	↓	↓
M123A10BP_131_	130	↓	↓	↓
M123A10BP_151_	150	↓	↓	↓
M123A10BP_161_	160	↓	↓	↓
M123A10BP_181_	180	↓	↓	↓
M123A10BP_201_	200	↓	↓	↓
M123A10BP_221_	220	↓	↓	↓
M123A10BP_241_	240	↓	↓	↓
M123A10BP_271_	270	↓	↓	↓
M123A10BP_301_	300	↓	↓	↓
M123A10BP_331_	330	↓	↓	↓
M123A10BP_361_	360	↓	↓	↓
M123A10BP_391_	390	↓	↓	↓
M123A10BP_431_	430	↓	↓	↓
M123A10BP_471_	470	F, J, K	BP	50,100
M123A10BPB511_	510	F, J, K	BP	50
M123A10BPB561_	560	↓	↓	↓
M123A10BPB621_	620	↓	↓	↓
M123A10BPB681_	680	F, J, K	BP	50
M123A10BX_331K_	330	K	BX	50,100
M123A10BX_391K_	390	↓	↓	↓
M123A10BX_471K_	470	↓	↓	↓
M123A10BX_561K_	560	↓	↓	↓
M123A10BX_681K_	680	↓	↓	↓
M123A10BX_821K_	820	↓	↓	↓
M123A10BX_102K_	1,000	↓	↓	↓
M123A10BX_122K_	1,200	↓	↓	↓
M123A10BX_152K_	1,500	↓	↓	↓
M123A10BX_182K_	1,800	↓	↓	↓
M123A10BX_222K_	2,200	↓	↓	↓
M123A10BX_272K_	2,700	↓	↓	↓
M123A10BX_332K_	3,300	↓	↓	↓
M123A10BX_392K_	3,900	↓	↓	↓
M123A10BX_472K_	4,700	K	BX	50,100
M123A10BXB562K_	5,600	K	BX	50
M123A10BXB682K_	6,800	↓	↓	↓
M123A10BXB822K_	8,200	↓	↓	↓
M123A10BXB103K_	10,000	↓	↓	↓
M123A10BXB123K_	12,000	↓	↓	↓
M123A10BXB153K_	15,000	↓	↓	↓
M123A10BXB183K_	18,000	K	BX	50

MIL-PRF-123/STYLE CKS52, -/11

Part Number 1/ (1210 Size Chip)	Capacitance pF	Capacitance Tolerance	Voltage- Temperature Limits	Rated Voltage
M123A11BP_301_	300	F, J, K	BP	50,100
M123A11BP_331_	330	↓	↓	↓
M123A11BP_361_	360			
M123A11BP_391_	390			
M123A11BP_431_	430			
M123A11BP_471_	470			
M123A11BP_511_	510			
M123A11BP_561_	560			
M123A11BP_621_	620			
M123A11BP_681_	680			
M123A11BP_751_	750			
M123A11BP_821_	820			
M123A11BP_911_	910			
M123A11BP_102_	1,000			
M123A11BP_112_	1,100			
M123A11BP_122_	1,200			
M123A11BP_132_	1,300			
M123A11BP_152_	1,500			
M123A11BP_162_	1,600			
M123A11BP_182_	1,800			
M123A11BP_202_	2,000			
M123A11BP_222_	2,200			
		F, J, K	BP	50,100

Part Number 1/ (1210 Size Chip)	Capacitance pF	Capacitance Tolerance	Voltage- Temperature Limits	Rated Voltage
M123A11BPB242_	2,400	F, J, K	BP	50
M123A11BPB272_	2,700	↓	↓	↓
M123A11BPB302_	3,000			
M123A11BPB332_	3,300			
		F, J, K	BP	50
M123A11BX_562_	5,600	K, M	BX	50,100
M123A11BX_682_	6,800	↓	↓	↓
M123A11BX_822_	8,200			
M123A11BX_103_	10,000			
M123A11BX_123_	12,000			
M123A11BX_153_	15,000			
M123A11BX_183_	18,000			
M123A11BX_223_	22,000			
M123A11BX_273_	27,000			
		K, M	BX	50,100
M123A11BxB333_	33,000	K, M	BX	50
M123A11BxB393_	39,000	↓	↓	↓
M123A11BxB473_	47,000			
M123A11BxB563_	56,000			
M123A11BxB683_	68,000			
M123A11BxB823_	82,000			
M123A11BxB104_	100,000			
		K, M	BX	50

MIL-PRF-123/STYLE CKS53, -/12

Part Number 1/ (1808 Size Chip)	Capacitance pF	Capacitance Tolerance	Voltage- Temperature Limits	Rated Voltage			
M123A12BP_301_	300	F, J, K	BP	50,100			
M123A12BP_331_	330	↓	↓	↓			
M123A12BP_361_	360						
M123A12BP_391_	390						
M123A12BP_431_	430						
M123A12BP_471_	470						
M123A12BP_511_	510						
M123A12BP_561_	560						
M123A12BP_621_	620						
M123A12BP_681_	680						
M123A12BP_751_	750						
M123A12BP_821_	820						
M123A12BP_911_	910						
M123A12BP_102_	1,000						
					F, J, K	BP	50,100

Part Number 1/ (1808 Size Chip)	Capacitance pF	Capacitance Tolerance	Voltage- Temperature Limits	Rated Voltage
M123A12BX_562K_	5,600	K	BX	50,100
M123A12BX_682K_	6,800	↓	↓	↓
M123A12BX_822K_	8,200			
M123A12BX_103K_	10,000			
M123A12BX_123K_	12,000			
M123A12BX_153K_	15,000			
M123A12BX_183K_	18,000			
M123A12BX_223K_	22,000			
M123A12BX_273K_	27,000			
M123A12BX_333K_	33,000			
		K	BX	50,100
M123A12BxB393K_	39,000	K	BX	50
M123A12BxB473K_	47,000	↓	↓	↓
M123A12BxB563K_	56,000			
M123A12BxB683K_	68,000			
M123A12BxB823K_	82,000			
M123A12BxB104K_	100,000			
		K	BX	50

MIL-PRF-123/STYLE CKS54, -/13

Part Number 1/ (2225 Size Chip)	Capacitance pF	Capacitance Tolerance	Voltage- Temperature Limits	Rated Voltage
M123A13BPB112_	1,100	F, J, K	BP	50
M123A13BPB122_	1,200	↓	↓	↓
M123A13BPB132_	1,300			
M123A13BPB152_	1,500			
M123A13BPB162_	1,600			
M123A13BPB182_	1,800			
M123A13BPB202_	2,000			
M123A13BPB222_	2,200			
M123A13BPB242_	2,400			
M123A13BPB272_	2,700			
M123A13BPB302_	3,000			
M123A13BPB332_	3,300			
M123A13BPB362_	3,600			
M123A13BPB392_	3,900			
M123A13BPB432_	4,300			
M123A13BPB472_	4,700			
M123A13BPB512_	5,100			
		F, J, K	BP	50

Part Number 1/ (2225 Size Chip)	Capacitance pF	Capacitance Tolerance	Voltage- Temperature Limits	Rated Voltage
M123A13BPB562_	5,600	F, J, K	BP	50
M123A13BPB622_	6,200	↓	↓	↓
M123A13BPB682_	6,800			
M123A13BPB752_	7,500			
M123A13BPB822_	8,200			
M123A13BPB912_	9,100			
M123A13BPB103_	10,000			
		F, J, K	BP	50
M123A13BxB124K_	120,000	K	BX	50
M123A13BxB154K_	150,000	↓	↓	↓
M123A13BxB184K_	180,000			
M123A13BxB224K_	220,000			
M123A13BxB274K_	270,000			
M123A13BxB334K_	330,000			
M123A13BxB394K_	394,000			
M123A13BxB474K_	474,000			
M123A13BxB105K_	1,000,000			
		K	BX	50

MIL-PRF-123/STYLE CKS55, -/21

Part Number 1/ (1206 Size Chip)	Capacitance pF	Capacitance Tolerance	Voltage-Temperature Limits	Rated Voltage
M123A21BPC1R0_	1.0	B, C	BP	100
M123A21BPC1R1_	1.1	↓	↓	↓
M123A21BPC1R2_	1.2			
M123A21BPC1R3_	1.3			
M123A21BPC1R5_	1.5			
M123A21BPC1R6_	1.6			
M123A21BPC1R8_	1.8			
M123A21BPC2R0_	2.0			
M123A21BPC2R2_	2.2			
M123A21BPC2R4_	2.4			
M123A21BPC2R7_	2.7			
M123A21BPC3R0_	3.0	B, C, D	↓	↓
M123A21BPC3R3_	3.3			
M123A21BPC3R6_	3.6			
M123A21BPC3R9_	3.9			
M123A21BPC4R3_	4.3			
M123A21BPC4R7_	4.7			
M123A21BPC5R1_	5.1			
M123A21BPC5R6_	5.6			
M123A21BPC6R2_	6.2			
M123A21BPC6R8_	6.8			
M123A21BPC7R5_	7.5	↓	↓	↓
M123A21BPC8R2_	8.2			
M123A21BPC9R1_	9.1			
M123A21BPC9R1_	9.1	B, C, D	BP	100

Part Number 1/ (1206 Size Chip)	Capacitance pF	Capacitance Tolerance	Voltage-Temperature Limits	Rated Voltage			
M123A21BPC100_	10	F, J, K	BP	100			
M123A21BPC110_	11	↓	↓	↓			
M123A21BPC120_	12						
M123A21BPC130_	13						
M123A21BPC150_	15						
M123A21BPC160_	16						
M123A21BPC180_	18						
M123A21BPC200_	20						
M123A21BPC240_	24						
M123A21BPC270_	27						
M123A21BPC330_	33						
M123A21BPC360_	36						
M123A21BPC390_	39						
M123A21BPC430_	43						
M123A21BPC470_	47						
M123A21BPC510_	51						
M123A21BPC560_	56						
M123A21BPC620_	62				↓	↓	↓
M123A21BPC680_	68						
M123A21BPC750_	75						
M123A21BPC820_	82						
M123A21BPC910_	91						
M123A21BPC101_	100	F, J, K	BP	100			

MIL-PRF-123/STYLE CKS55, -/21

Part Number 1/ (1206 Size Chip)	Capacitance pF	Capacitance Tolerance	Voltage-Temperature Limits	Rated Voltage
M123A21BPC111_	110	F, J, K	BP	100
M123A21BPC121_	120	↓	↓	↓
M123A21BPC131_	130			
M123A21BPC151_	150			
M123A21BPC161_	160			
M123A21BPC181_	180			
M123A21BPC201_	200			
M123A21BPC221_	220			
M123A21BPC241_	240			
M123A21BPC271_	270			
M123A21BPC301_	300			
M123A21BPC331_	330			
M123A21BPC361_	360			
M123A21BPC391_	390			
M123A21BPC431_	430			
M123A21BPC471_	470			
M123A21BPC511_	510			
M123A21BPC561_	560			
M123A21BPC621_	620			
M123A21BPC681_	680			
M123A21BPC751_	750	↓	↓	↓
M123A21BPC821_	820			
M123A21BPC911_	910			
M123A21BPC102_	1,000			
M123A21BPC102_	1,000	F, J, K	BP	100

Part Number 1/ (1206 Size Chip)	Capacitance pF	Capacitance Tolerance	Voltage-Temperature Limits	Rated Voltage			
M123A21BPB112_	1,100	F, J, K	BP	50			
M123A21BPB122_	1,200	↓	↓	↓			
M123A21BPB132_	1,300						
M123A21BPB152_	1,500						
M123A21BPB162_	1,600						
M123A21BPB182_	1,800						
M123A21BPB202_	2,000						
M123A21BPB222_	2,200				F, J, K	BP	50
M123A21BXC472_	4,700				↓	↓	↓
M123A21BXC562_	5,600						
M123A21BXC682_	6,800						
M123A21BXC822_	8,200						
M123A21BXC103_	10,000	↓	↓	↓			
M123A21BXC123_	12,000						
M123A21BXC153_	15,000				K, M	BX	100
M123A21BXC183_	18,000						
M123A21BXC223_	22,000	↓	↓	↓			
M123A21BXC273_	27,000						
M123A21BXC333_	33,000				K, M	BX	50
M123A21BXC393_	39,000						
M123A21BXC393_	39,000	K, M	BX	50			

MIL-PRF-123/STYLE CKS56, -/22

Part Number 1/ (1812 Size Chip)	Capacitance pF	Capacitance Tolerance	Voltage- Temperature Limits	Rated Voltage
M123A22BPC122_	1,200	F, J, K	BP	100
M123A22BPC152_	1,500	↓	↓	↓
M123A22BPC182_	1,800	↓	↓	↓
M123A22BPC222_	2,200	↓	↓	↓
M123A22BPC242_	2,400	↓	↓	↓
M123A22BPC272_	2,700	↓	↓	↓
M123A22BPC302_	3,000	↓	↓	↓
M123A22BPC332_	3,300	↓	↓	↓
M123A22BPC362_	3,600	↓	↓	↓
M123A22BPC392_	3,900	↓	↓	↓
M123A22BPC432_	4,300	↓	↓	↓
M123A22BPC472_	4,700	F, J, K	BP	100
M123A22BPB512_	5,100	F, J, K	BP	50
M123A22BPB562_	5,600	↓	↓	↓
M123A22BPB622_	6,200	↓	↓	↓
M123A22BPB682_	6,800	↓	↓	↓
M123A22BPB752_	7,500	↓	↓	↓
M123A22BPB822_	8,200	↓	↓	↓
M123A22BPB912_	9,100	↓	↓	↓
M123A22BPB103_	10,000	F, J, K	BP	50

Part Number 1/ (1812 Size Chip)	Capacitance pF	Capacitance Tolerance	Voltage- Temperature Limits	Rated Voltage
M123A22BXC273_	27,000	K, M	BX	100
M123A22BXC333_	33,000	↓	↓	↓
M123A22BXC393_	39,000	↓	↓	↓
M123A22BXC473_	47,000	↓	↓	↓
M123A22BXC563_	56,000	K, M	BX	100
M123A22BXC823_	82,000	K, M	BX	50
M123A22BXC104_	100,000	↓	↓	↓
M123A22BXC124_	120,000	↓	↓	↓
M123A22BXC154_	150,000	↓	↓	↓
M123A22BXC184_	180,000	K, M	BX	50

MIL-PRF-123/STYLE CKS57, -/23

Part Number 1/ (1825 Size Chip)	Capacitance pF	Capacitance Tolerance	Voltage- Temperature Limits	Rated Voltage
M123A23BPC392_	3,900	F, J, K	BP	100
M123A23BPC472_	4,700	↓	↓	↓
M123A23BPC512_	5,100	↓	↓	↓
M123A23BPC562_	5,600	↓	↓	↓
M123A23BPC622_	6,200	↓	↓	↓
M123A23BPC682_	6,800	↓	↓	↓
M123A23BPC752_	7,500	↓	↓	↓
M123A23BPC822_	8,200	↓	↓	↓
M123A23BPC912_	9,100	↓	↓	↓
M123A23BPC103_	10,000	F, J, K	BP	100
M123A23BPB113_	11,000	F, J, K	BP	50
M123A23BPB123_	12,000	↓	↓	↓
M123A23BPB133_	13,000	↓	↓	↓
M123A23BPB153_	15,000	↓	↓	↓
M123A23BPB163_	16,000	↓	↓	↓
M123A23BPB183_	18,000	↓	↓	↓
M123A23BPB203_	20,000	↓	↓	↓
M123A23BPB223_	22,000	F, J, K	BP	50

Part Number 1/ (1825 Size Chip)	Capacitance pF	Capacitance Tolerance	Voltage- Temperature Limits	Rated Voltage
M123A23BXC563_	56,000	K, M	BX	100
M123A23BXC683_	68,000	↓	↓	↓
M123A23BXC823_	82,000	↓	↓	↓
M123A23BXC104_	100,000	↓	↓	↓
M123A23BXC124_	120,000	↓	↓	↓
M123A23BXC154_	150,000	K, M	BX	100
M123A23BXC184_	180,000	K, M	BX	50
M123A23BXC224_	220,000	↓	↓	↓
M123A23BXC274_	270,000	↓	↓	↓
M123A23BXC334_	330,000	↓	↓	↓
M123A23BXC394_	390,000	↓	↓	↓
M123A23BXC474_	470,000	K, M	BX	50

MLC Chip Capacitors

AT Series – High Temperature MLCC – 200°C & 250°C Rated

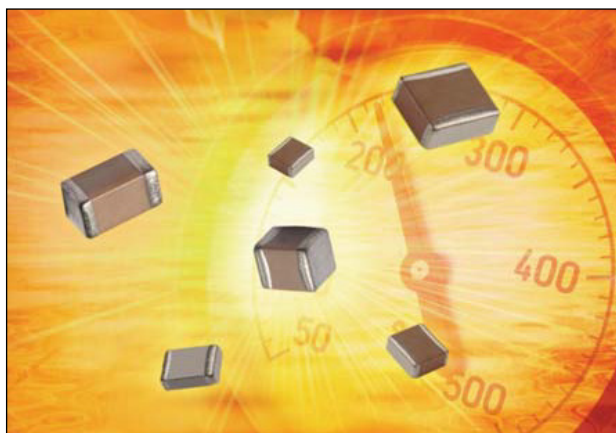

Present military specifications, as well as a majority of commercial applications, require a maximum operating temperature of 125°C. However, the emerging market for high temperature electronics demands capacitors operating reliably at temperatures beyond 125°C. AVX's high temperature chip capacitor product line, has been extended with the BME COG chip. All AT chips have verified capabilities of long term operation up to 250°C for applications in both military and commercial businesses. These capacitors demonstrate high volumetric efficiency, high insulation resistance and low ESR/ESL for the most demanding applications, such as "down-hole" oil exploration and aerospace programs.

HOW TO ORDER

AT10	3	T	104	K	A	T	2	A
AVX Style	Voltage Code	Temperature Coefficient	Capacitance Code (2 significant digits + no. of zeros)	Capacitance Tolerance	Test Level	Termination	Packaging	Special Code
AT03 = 0603 AT05 = 0805 AT06 = 1206 AT10 = 1210 AT12 = 1812 AT14 = 2225	16V = Y 25V = 3 50V = 5	PME COG 250°C = A COG 200°C = 2 VHT 250°C = T VHT 200°C = 4 BME COG 250°C = 5 COG 200°C = 3	101 = 100pF 102 = 1nF 103 = 10nF 104 = 100nF 105 = 1µF	J = ±5% K = ±10% M = ±20%	A = Standard	1 = Pd/Ag T = 100% Sn Plated (RoHS Compliant) 7 = Ni/Au Plated (For 250°C BME COG Only)	2 = 7" Reel 4 = 13" Reel 9 = Bulk	A = Standard

ELECTRICAL SPECIFICATIONS

Temperature Coefficient

PME COG 0±30ppm/°C, -55C to 250°C
BME COG 0±30ppm/°C, -55C to 200°C
See TCC Plot for +250°C

VHT: T ±15%, -55°C to +150°C
See TCC Plot for +250°C

Capacitance Test (MIL-STD-202, Method 305)
25°C, 1.0 ± 0.2 Vrms (open circuit voltage) @ 1kHz

Dissipation factor 25°C

COG: 0.15% Max at 1.0 ± 0.2 Vrms (open circuit voltage) @ 1kHz
VHT: 2.5% Max at 1.0 ± 0.2 Vrms (open circuit voltage) @ 1kHz

Insulation Resistance 25°C (MIL-STD-202, Method 302)
100GΩ or 1000MΩ-µF (whichever is less)

Insulation Resistance 125°C (MIL-STD-202, Method 302)
10GΩ or 100MΩ-µF (whichever is less)

Insulation Resistance 200°C (MIL-STD-202, Method 302)
1GΩ or 10MΩ-µF (whichever is less)

Insulation Resistance 250°C (MIL-STD-202, Method 302)
100MΩ or 1MΩ-µF (whichever is less)

Direct Withstanding Voltage 25°C (Flash Test)
250% rated voltage for 5 seconds with 50mA max charging current

DIMENSIONS

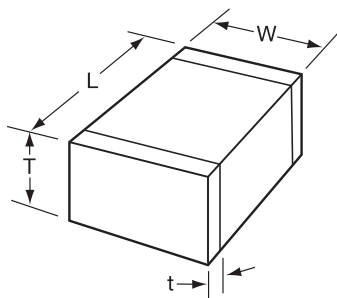

millimeters (inches)

Size	AT03 = 0603	AT05 = 0805	AT06 = 1206	AT10 = 1210	AT12 = 1812	AT14 = 2225
(L) Length	1.60 ± 0.15 (0.063 ± 0.006)	2.01 ± 0.20 (0.079 ± 0.008)	3.20 ± 0.20 (0.126 ± 0.008)	3.20 ± 0.20 (0.126 ± 0.008)	4.50 ± 0.30 (0.177 ± 0.012)	5.72 ± 0.25 (0.225 ± 0.010)
(W) Width	0.81 ± 0.15 (0.032 ± 0.006)	1.25 ± 0.20 (0.049 ± 0.008)	1.60 ± 0.20 (0.063 ± 0.008)	2.50 ± 0.20 (0.098 ± 0.008)	3.20 ± 0.20 (0.126 ± 0.008)	6.35 ± 0.25 (0.250 ± 0.010)
(T) Thickness Max.	1.02 (0.040)	1.30 (0.051)	1.52 (0.060)	1.70 (0.067)	2.54 (0.100)	2.54 (0.100)
(t) terminal	min. 0.25 (0.010) max. 0.75 (0.030)	0.25 (0.010) 0.75 (0.030)	0.25 (0.010) 0.75 (0.030)	0.25 (0.010) 0.75 (0.030)	0.25 (0.010) 1.02 (0.040)	0.25 (0.010) 1.02 (0.040)

MLC Chip Capacitors

AT Series – High Temperature MLCC – 200°C & 250°C Rated



PERFORMANCE CHARACTERISTICS

Typical Temperature Coefficient of Capacitance (VHT Dielectric)

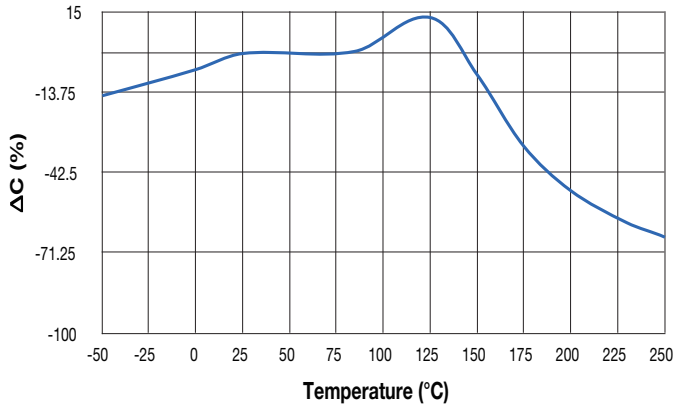

Typical Temperature Coefficient of Capacitance (COG Dielectric)

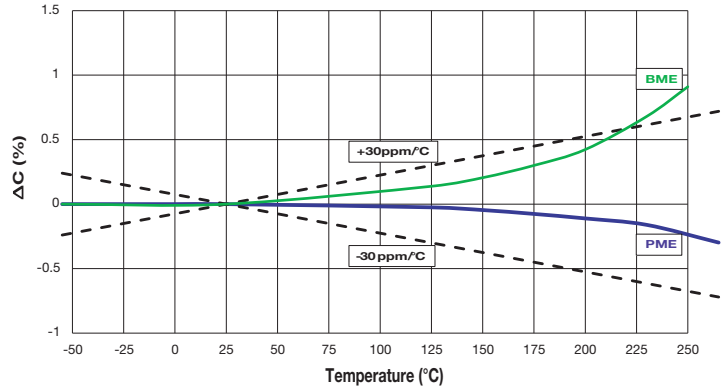

Typical Voltage Coefficient of Capacitance (VHT Dielectric)

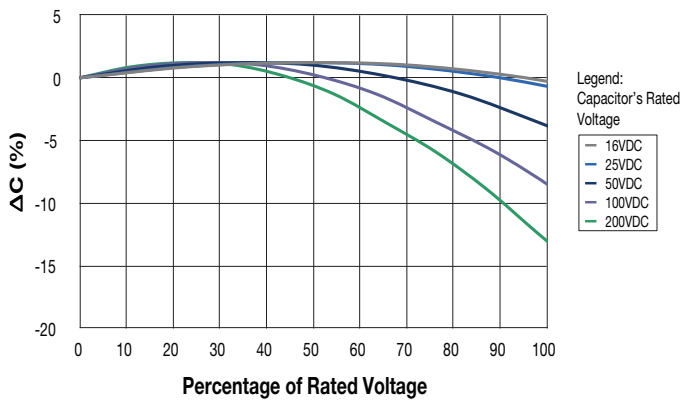

Typical Voltage Coefficient of Capacitance (COG Dielectric)

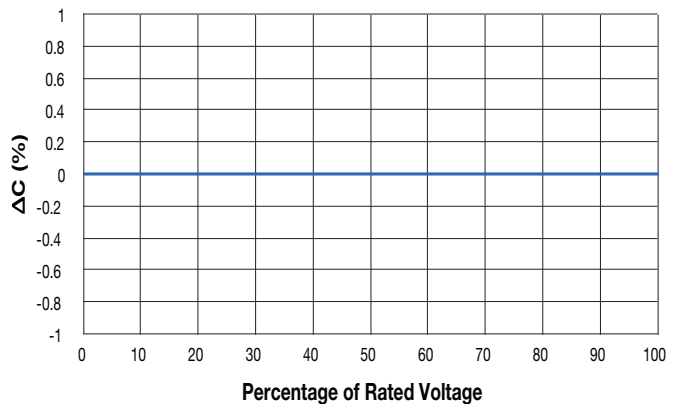

Typical RC vs Temperature (VHT Dielectric)

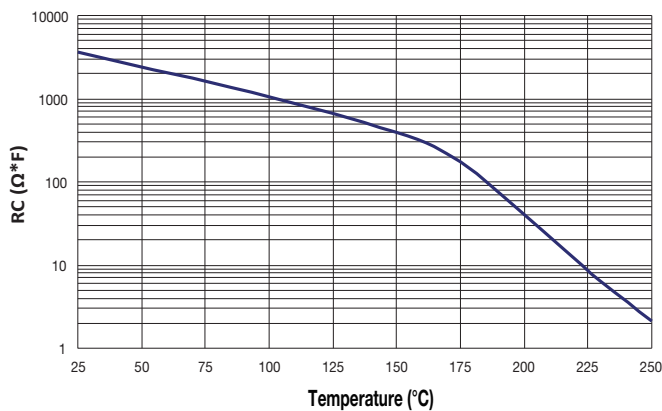

Typical RC vs Temperature (COG Dielectric)

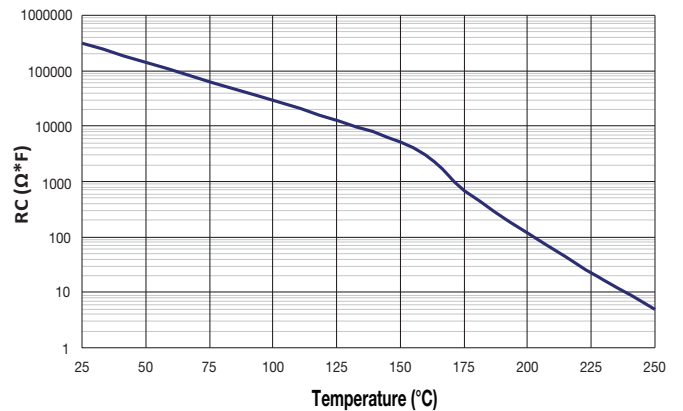

MLC Chip Capacitors

AT Series – High Temperature MLCC – 200°C & 250°C Rated



RELIABILITY

250°C Life Test @ 2x Rated Voltage (VHT Dielectric)

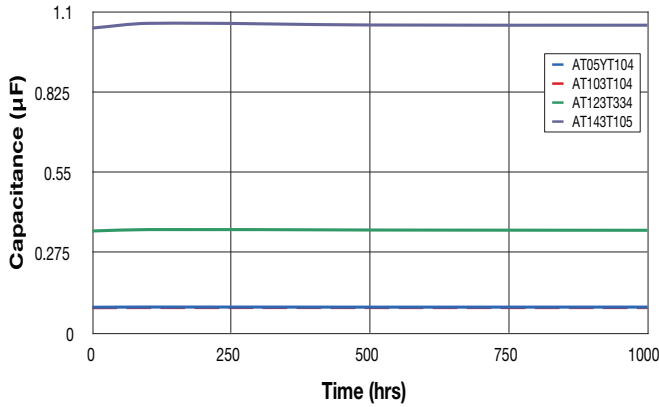

250°C Life Test @ 2x Rated Voltage (COG Dielectric)

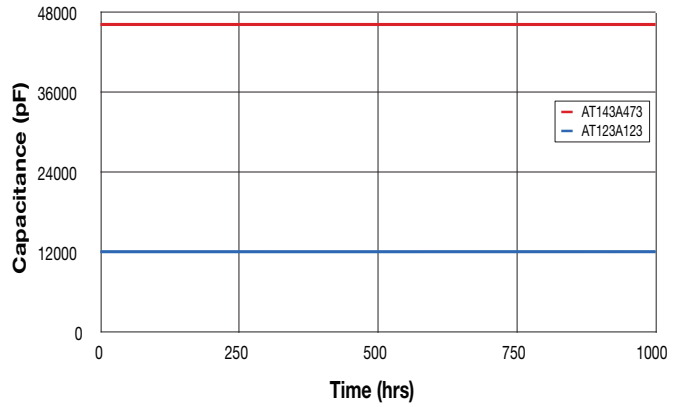

VHT - Failure Rate @ 90% Confidence Level (%/1000 hours)		
Temperature (°C)	50% Rated Voltage	100% Rated Voltage
200	0.002	0.017
250	0.026	0.210

*Typical 1210, 1812, 2225 Failure Rate Analysis based on 250°C testing and voltage ratings specified on the following page.

COG - Failure Rate @ 90% Confidence Level (%/1000 hours)		
Temperature (°C)	50% Rated Voltage	100% Rated Voltage
200	0.006	0.047
250	0.074	0.590

*Typical 1812 and 2225 Failure Rate Analysis based on 250°C testing and voltage ratings specified on the following page.

FREQUENCY RESPONSE

Impedance Frequency Response (VHT Dielectric)

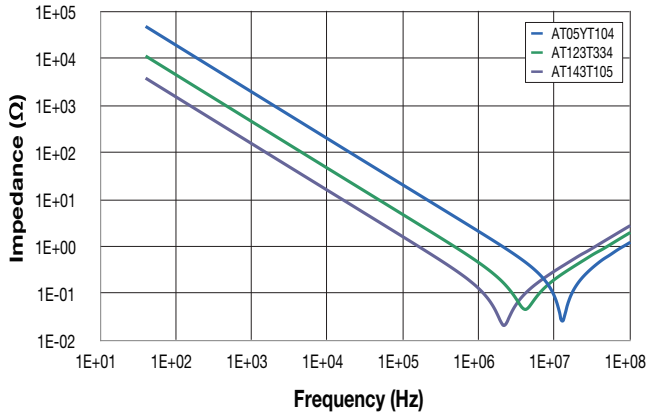

Impedance Frequency Response (COG Dielectric)

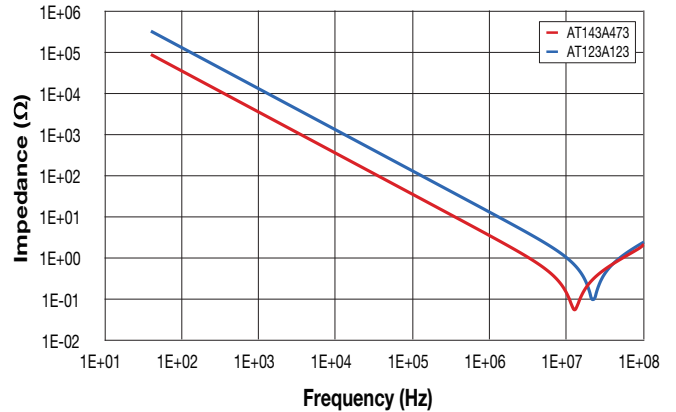

ESR Frequency Response (VHT Dielectric)

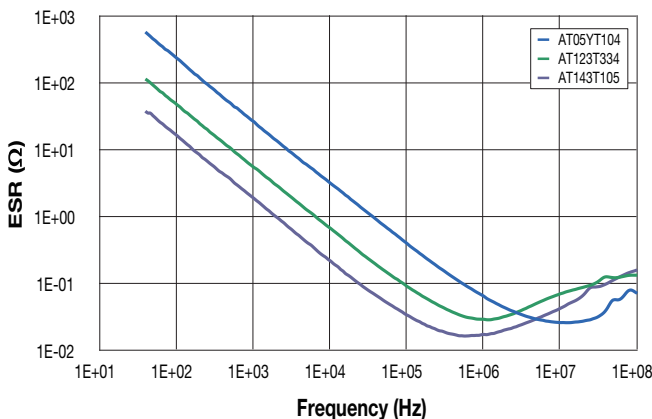

ESR Frequency Response (COG Dielectric)

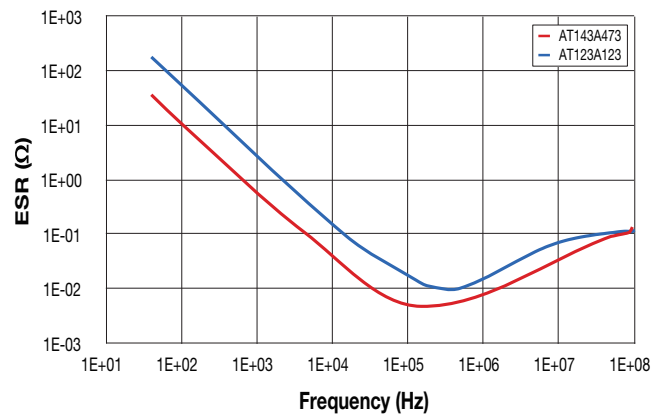

MLC Chip Capacitors

AT Series – High Temperature MLCC – 200°C & 250°C Rated



CAPACITANCE RANGE

PREFERRED SIZES ARE SHADED

VHT Temp. Coefficient: 4 200°C Rated

Case Size	AT03 = 0603	AT05 = 0805	AT06 = 1206	AT10 = 1210	AT12 = 1812	AT14 = 2225
Soldering	Reflow/Wave	Reflow/Wave	Reflow/Wave	Reflow Only	Reflow Only	Reflow Only
(L) Length mm (in.)	1.60 ± 0.15 (0.063 ± 0.006)	2.01 ± 0.20 (0.079 ± 0.008)	3.20 ± 0.20 (0.126 ± 0.008)	3.20 ± 0.20 (0.126 ± 0.008)	4.50 ± 0.30 (0.177 ± 0.012)	5.72 ± 0.25 (0.225 ± 0.010)
(W) Width mm (in.)	0.81 ± 0.15 (0.032 ± 0.006)	1.25 ± 0.20 (0.049 ± 0.008)	1.60 ± 0.20 (0.063 ± 0.008)	2.50 ± 0.20 (0.098 ± 0.008)	3.20 ± 0.20 (0.126 ± 0.008)	6.35 ± 0.25 (0.250 ± 0.010)
(T) Thickness mm (in.)	1.02 (0.040)	1.30 (0.051)	1.52 (0.060)	1.70 (0.067)	2.54 (0.100)	2.54 (0.100)
(t) Terminal mm (in.)	0.25 (0.010) 0.75 (0.030)	0.25 (0.010) 0.75 (0.030)	0.25 (0.010) 0.75 (0.030)	0.25 (0.010) 0.75 (0.030)	0.25 (0.010) 1.02 (0.040)	0.25 (0.010) 1.02 (0.040)
Rated Temp. (°C)	200	200	200	200	200	200
Temp. Coefficient	4	4	4	4	4	4
Voltage (V)	25	25 50	25 50	25 50	50	50
Cap (pF)	1000 102 1200 122 1500 152 1800 182 2200 222 2700 272 3300 332 3900 392 4700 472 5600 562 6800 682 8200 822					
Cap (µF)	0.010 103 0.012 123 0.015 153 0.018 183 0.022 223 0.027 273 0.033 333 0.039 393 0.047 473 0.056 563 0.068 683 0.082 823 0.100 104 0.120 124 0.150 154 0.180 184 0.220 224 0.270 274 0.330 334 0.390 394 0.470 474 0.560 564 0.680 684 0.820 824 1.000 105					
Voltage (V)	25	25 50	25 50	25 50	50	50
Rated Temp. (°C)	200	200	200	200	200	200
Case Size	AT03 = 0603	AT05 = 0805	AT06 = 1206	AT10 = 1210	AT12 = 1812	AT14 = 2225

VHT Temp. Coefficient: T 250°C Rated

Case Size	AT03 = 0603	AT05 = 0805	AT06 = 1206	AT10 = 1210	AT12 = 1812	AT14 = 2225
Soldering	Reflow/Wave	Reflow/Wave	Reflow/Wave	Reflow Only	Reflow Only	Reflow Only
(L) Length mm (in.)	1.60 ± 0.15 (0.063 ± 0.006)	2.01 ± 0.20 (0.079 ± 0.008)	3.20 ± 0.20 (0.126 ± 0.008)	3.20 ± 0.20 (0.126 ± 0.008)	4.50 ± 0.30 (0.177 ± 0.012)	5.72 ± 0.25 (0.225 ± 0.010)
(W) Width mm (in.)	0.81 ± 0.15 (0.032 ± 0.006)	1.25 ± 0.20 (0.049 ± 0.008)	1.60 ± 0.20 (0.063 ± 0.008)	2.50 ± 0.20 (0.098 ± 0.008)	3.20 ± 0.20 (0.126 ± 0.008)	6.35 ± 0.25 (0.250 ± 0.010)
(T) Thickness mm (in.)	1.02 (0.040)	1.30 (0.051)	1.52 (0.060)	1.70 (0.067)	2.54 (0.100)	2.54 (0.100)
(t) Terminal mm (in.)	0.25 (0.010) 0.75 (0.030)	0.25 (0.010) 0.75 (0.030)	0.25 (0.010) 0.75 (0.030)	0.25 (0.010) 0.75 (0.030)	0.25 (0.010) 1.02 (0.040)	0.25 (0.010) 1.02 (0.040)
Rated Temp. (°C)	250	250	250	250	250	250
Temp. Coefficient	T	T	T	T	T	T
Voltage (V)	16	16 25	16 25	16 25	25	25
Cap (pF)	1000 102 1200 122 1500 152 1800 182 2200 222 2700 272 3300 332 3900 392 4700 472 5600 562 6800 682 8200 822					
Cap (µF)	0.010 103 0.012 123 0.015 153 0.018 183 0.022 223 0.027 273 0.033 333 0.039 393 0.047 473 0.056 563 0.068 683 0.082 823 0.100 104 0.120 124 0.150 154 0.180 184 0.220 224 0.270 274 0.330 334 0.390 394 0.470 474 0.560 564 0.680 684 0.820 824 1.000 105					
Voltage (V)	16	16 25	16 25	16 25	25	25
Rated Temp. (°C)	250	250	250	250	250	250
Case Size	AT03 = 0603	AT05 = 0805	AT06 = 1206	AT10 = 1210	AT12 = 1812	AT14 = 2225

Voltage rating per table. Capacitance values specified at 25°C, derate capacitance value based on TCC and VCC Plots on page 112.

NOTE: Contact factory for non-specified capacitance values.



The Important Information/Disclaimer is incorporated in the catalog where these specifications came from or available online at www.avx.com/disclaimer/ by reference and should be reviewed in full before placing any order.

MLC Chip Capacitors

AT Series – High Temperature MLCC – 200°C & 250°C Rated



CAPACITANCE RANGE

PREFERRED SIZES ARE SHADED

BME COG Temp. Coefficient: 3 200°C Rated

Case Size	AT03 = 0603		AT05 = 0805		AT06 = 1206	
Soldering	Reflow/Wave		Reflow/Wave		Reflow/Wave	
(L) Length	mm	1.60 ± 0.15	mm	2.01 ± 0.20	mm	3.20 ± 0.20
	(in.)	(0.063 ± 0.006)	(in.)	(0.079 ± 0.008)	(in.)	(0.126 ± 0.008)
(W) Width	mm	0.81 ± 0.15	mm	1.25 ± 0.20	mm	1.60 ± 0.20
	(in.)	(0.032 ± 0.006)	(in.)	(0.049 ± 0.008)	(in.)	(0.063 ± 0.008)
(T) Thickness	mm	1.02	mm	1.30	mm	1.52
	(in.)	(0.040)	(in.)	(0.051)	(in.)	(0.060)
(t) Terminal	mm	0.25 (0.010)	mm	0.25 (0.010)	mm	0.25 (0.010)
	(in.)	0.75 (0.030)	(in.)	0.75 (0.030)	(in.)	0.75 (0.030)
Rated Temp. (°C)	250		250		250	
Temp. Coefficient	3		3		3	
Voltage (V)	25	50	25	50	25	50
Cap (pF)	39	390				
	47	470				
	56	560				
	68	680				
	82	820				
	100	101				
	120	121				
	150	151				
	180	181				
	220	221				
	270	271				
	330	331				
Cap (µF)	390	391				
	470	471				
	560	561				
	680	681				
	820	821				
	1000	102				
	1200	122				
	1500	152				
	1800	182				
	2200	222				
	2700	272				
	3300	332				
	3900	392				
	4700	472				
	5600	562				
	6800	682				
	8200	822				
Cap (µF)	0.010	103				
	0.012	123				
	0.015	153				
	0.018	183				
	0.022	223				
	0.027	273				
	0.033	333				
	0.039	393				
	0.047	473				
	0.056	563				
	0.068	683				
	0.082	823				
	0.100	104				
Voltage (V)	25	50	25	50	25	50
Rated Temp. (°C)	200		200		200	
Case Size	AT03 = 0603		AT05 = 0805		AT06 = 1206	

BME COG (Ni/Au) Temp. Coefficient: 5 250°C Rated

Case Size	AT03 = 0603		AT05 = 0805		AT06 = 1206	
Soldering	Reflow/Wave		Reflow/Wave		Reflow/Wave	
(L) Length	mm	1.60 ± 0.15	mm	2.01 ± 0.20	mm	3.20 ± 0.20
	(in.)	(0.063 ± 0.006)	(in.)	(0.079 ± 0.008)	(in.)	(0.126 ± 0.008)
(W) Width	mm	0.81 ± 0.15	mm	1.25 ± 0.20	mm	1.60 ± 0.20
	(in.)	(0.032 ± 0.006)	(in.)	(0.049 ± 0.008)	(in.)	(0.063 ± 0.008)
(T) Thickness	mm	1.02	mm	1.30	mm	1.52
	(in.)	(0.040)	(in.)	(0.051)	(in.)	(0.060)
(t) Terminal	mm	0.25 (0.010)	mm	0.25 (0.010)	mm	0.25 (0.010)
	(in.)	0.75 (0.030)	(in.)	0.75 (0.030)	(in.)	0.75 (0.030)
Rated Temp. (°C)	250		250		250	
Temp. Coefficient	5		5		5	
Voltage (V)	25		25		25	
Cap (pF)	39	390				
	47	470				
	56	560				
	68	680				
	82	820				
	100	101				
	120	121				
	150	151				
	180	181				
	220	221				
	270	271				
	330	331				
	390	391				
	470	471				
	560	561				
	680	681				
	820	821				
	1000	102				
	1200	122				
	1500	152				
	1800	182				
	2200	222				
	2700	272				
	3300	332				
	3900	392				
	4700	472				
	5600	562				
	6800	682				
	8200	822				
Cap (µF)	0.010	103				
	0.012	123				
	0.015	153				
	0.018	183				
	0.022	223				
	0.027	273				
	0.033	333				
	0.039	393				
	0.047	473				
	0.056	563				
	0.068	683				
	0.082	823				
	0.100	104				
Voltage (V)	25		25		25	
Rated Temp. (°C)	250		250		250	
Case Size	AT03 = 0603		AT05 = 0805		AT06 = 1206	

Voltage rating per table. Capacitance values specified at 25°C, derate capacitance value based on TCC and VCC Plots on page 112.

NOTE: Contact factory for non-specified capacitance values.



MLC Chip Capacitors

AT Series – High Temperature MLCC – 200°C & 250°C Rated



CAPACITANCE RANGE

PREFERRED SIZES ARE SHADED

PME COG Temp. Coefficient: 2 200°C Rated

Case Size	AT05 = 0805	AT06 = 1206	AT10 = 1210	AT12 = 1812	AT14 = 2225
Soldering	Reflow/Wave	Reflow/Wave	Reflow Only	Reflow Only	Reflow Only
(L) Length	mm (in.)	mm (in.)	mm (in.)	mm (in.)	mm (in.)
(W) Width	mm (in.)	mm (in.)	mm (in.)	mm (in.)	mm (in.)
(T) Thickness	mm (in.)	mm (in.)	mm (in.)	mm (in.)	mm (in.)
(t) Terminal	mm (in.)	mm (in.)	mm (in.)	mm (in.)	mm (in.)
Rated Temp. (°C)	200	200	200	200	200
Temp. Coefficient	2	2	2	2	2
Voltage (V)	50	50	50	50	50
Cap (pF)	100 101				
	120 121				
	150 151				
	180 181				
	220 221				
	270 271				
	330 331				
	390 391				
	470 471				
	560 561				
	680 681				
	820 821				
	1000 102				
	1200 122				
	1500 152				
	1800 182				
	2200 222				
	2700 272				
	3300 332				
	3900 392				
	4700 472				
	5600 562				
	6800 682				
	8200 822				
Cap (µF)	0.010 103				
	0.012 123				
	0.015 153				
	0.018 183				
	0.022 223				
	0.027 273				
	0.033 333				
	0.039 393				
	0.047 473				
	0.056 563				
	0.068 683				
	0.082 823				
	0.100 104				
Voltage (V)	50	50	50	50	50
Rated Temp. (°C)	200	200	200	200	200
Case Size	AT05 = 0805	AT06 = 1206	AT10 = 1210	AT12 = 1812	AT14 = 2225

PME COG Temp. Coefficient: A 250°C Rated

Case Size	AT05 = 0805	AT06 = 1206	AT10 = 1210	AT12 = 1812	AT14 = 2225
Soldering	Reflow/Wave	Reflow/Wave	Reflow Only	Reflow Only	Reflow Only
(L) Length	mm (in.)	mm (in.)	mm (in.)	mm (in.)	mm (in.)
(W) Width	mm (in.)	mm (in.)	mm (in.)	mm (in.)	mm (in.)
(T) Thickness	mm (in.)	mm (in.)	mm (in.)	mm (in.)	mm (in.)
(t) Terminal	mm (in.)	mm (in.)	mm (in.)	mm (in.)	mm (in.)
Rated Temp. (°C)	250	250	250	250	250
Temp. Coefficient	A	A	A	A	A
Voltage (V)	25	25	25	25	25
Cap (pF)	100 101				
	120 121				
	150 151				
	180 181				
	220 221				
	270 271				
	330 331				
	390 391				
	470 471				
	560 561				
	680 681				
	820 821				
	1000 102				
	1200 122				
	1500 152				
	1800 182				
	2200 222				
	2700 272				
	3300 332				
	3900 392				
	4700 472				
	5600 562				
	6800 682				
	8200 822				
Cap (µF)	0.010 103				
	0.012 123				
	0.015 153				
	0.018 183				
	0.022 223				
	0.027 273				
	0.033 333				
	0.039 393				
	0.047 473				
	0.056 563				
	0.068 683				
	0.082 823				
	0.100 104				
Voltage (V)	25	25	25	25	25
Rated Temp. (°C)	250	250	250	250	250
Case Size	AT05 = 0805	AT06 = 1206	AT10 = 1210	AT12 = 1812	AT14 = 2225

Voltage rating per table. Capacitance values specified at 25°C, derate capacitance value based on TCC and VCC Plots on page 112.

NOTE: Contact factory for non-specified capacitance values.



The Important Information/Disclaimer is incorporated in the catalog where these specifications came from or available online at www.avx.com/disclaimer/ by reference and should be reviewed in full before placing any order.

MLC Chip Capacitors

High Voltage MLC Chips – For 600V to 5000V Applications

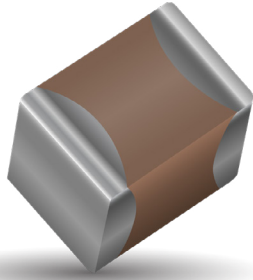

High value, low leakage and small size are difficult parameters to obtain in capacitors for high voltage systems. AVX special high voltage MLC chip capacitors meet these performance characteristics and are designed for applications such as snubbers in high frequency power converters, resonators in SMPS, and high voltage coupling/dc blocking. These high voltage chip designs exhibit low ESRs at high frequencies.

Larger physical sizes than normally encountered chips are used to make high voltage MLC chip products. Special precautions must be taken in applying these chips in surface mount assemblies. The temperature gradient during heating or cooling cycles should not exceed 4°C per second. The preheat temperature must be within 50°C of the peak temperature reached by the ceramic bodies through the soldering process. Chip sizes 1210 and larger should be reflow soldered only. Capacitors may require protective surface coating to prevent external arcing.

For 1825, 2225 and 3640 sizes, AVX offers leaded version in either thru-hole or SMT configurations (for details see section on high voltage leaded MLC chips)

NEW 630V RANGE

HOW TO ORDER

1808	A	A	271	M	A	1	2	A
AVX Style	Voltage	Temperature Coefficient	Capacitance Code (2 significant digits + no. of zeros)	Capacitance Tolerance	Test Level	Termination*	Packaging**	Special Code
0805 1206 1210 1808 1812 1825 2220 2225 3640	600V/630V = C 1000V = A 1500V = S 2000V = G 2500V = W 3000V = H 4000V = J 5000V = K	NPO (C0G) = A X7R = C	Examples: 10 pF = 100 100 pF = 101 1,000 pF = 102 22,000 pF = 223 220,000 pF = 224 1 μF = 105	C0G: J = ±5% K = ±10% M = ±20% X7R: K = ±10% M = ±20% Z = +80%, -20%	A = Standard	1 = Pd/Ag T = Plated Ni and Sn (RoHS Compliant)	1 or 2 = 7" Reel** 3 or 4 = 13" Reel	A = Standard

Notes:

- Capacitors with X7R dielectrics are not intended for applications across AC supply mains or AC line filtering with polarity reversal. Contact plant for recommendations. Contact factory for availability of Termination and Tolerance options for Specific Part Numbers.
- *Terminations with 5% minimum lead (Pb) is available, see pages 100 and 101 for LD style. Leaded terminations are available, see pages 102-106.

**The 3640 Style is not available on 7" Reels.

*** AVX offers nonstandard chip sizes. Contact factory for details.

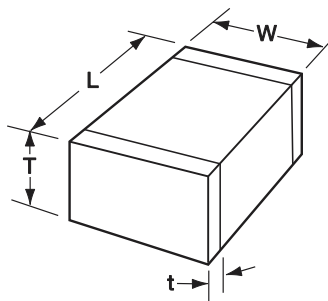

DIMENSIONS

millimeters (inches)

SIZE	0805	1206	1210*	1808*	1812*	1825*	2220*	2225*	3640*
(L) Length	2.10 ± 0.20 (0.083 ± 0.008)	3.30 ± 0.30 (0.130 ± 0.012)	3.30 ± 0.40 (0.130 ± 0.016)	4.60 ± 0.50 (0.181 ± 0.020)	4.60 ± 0.50 (0.181 ± 0.020)	4.60 ± 0.50 (0.181 ± 0.020)	5.70 ± 0.50 (0.224 ± 0.020)	5.72 ± 0.25 (0.225 ± 0.010)	9.14 ± 0.25 (0.360 ± 0.010)
(W) Width	1.25 ± 0.20 (0.049 ± 0.008)	1.60 ± 0.20 (0.063 ± 0.008)	2.50 ± 0.30 (0.098 ± 0.012)	2.00 ± 0.20 (0.079 ± 0.008)	3.20 ± 0.30 (0.126 ± 0.012)	6.30 ± 0.40 (0.248 ± 0.016)	5.00 ± 0.40 (0.197 ± 0.016)	6.35 ± 0.25 (0.250 ± 0.010)	10.2 ± 0.25 (0.400 ± 0.010)
(T) Thickness Max.	1.35 (0.053)	1.80 (0.071)	2.80 (0.110)	2.20 (0.087)	2.80 (0.110)	3.40 (0.134)	3.40 (0.134)	2.54 (0.100)	2.54 (0.100)
(t) terminal min. max.	0.50 ± 0.20 (0.020 ± 0.008)	0.60 ± 0.20 (0.024 ± 0.008)	0.75 ± 0.35 (0.030 ± 0.014)	0.75 ± 0.35 (0.030 ± 0.014)	0.75 ± 0.35 (0.030 ± 0.014)	0.75 ± 0.35 (0.030 ± 0.014)	0.85 ± 0.35 (0.033 ± 0.014)	0.85 ± 0.35 (0.033 ± 0.014)	0.76 (0.030) 1.52 (0.060)

*Reflow Soldering Only



MLC Chip Capacitors

High Voltage MLC Chips – For 600V to 5000V Applications



NP0 (C0G) DIELECTRIC – PERFORMANCE CHARACTERISTICS

Capacitance Range	10 pF to 0.100 µF (25°C, 1.0 ±0.2 Vrms at 1kHz, for ≤ 1000 pF use 1 MHz)
Capacitance Tolerances	±5%, ±10%, ±20%
Dissipation Factor	0.1% max. (+25°C, 1.0 ±0.2 Vrms, 1kHz, for ≤ 1000 pF use 1 MHz)
Operating Temperature Range	-55°C to +125°C
Temperature Characteristic	0 ±30 ppm/°C (0 VDC)
Voltage Ratings	600, 630, 1000, 1500, 2000, 2500, 3000, 4000 & 5000 VDC (+125°C)
Insulation Resistance (+25°C, at 500 VDC)	100K MΩ min. or 1000 MΩ - µF min., whichever is less
Insulation Resistance (+125°C, at 500 VDC)	10K MΩ min. or 100 MΩ - µF min., whichever is less
Dielectric Strength	Minimum 120% rated voltage for 5 seconds at 50 mA max. current

NP0 (C0G) CAPACITANCE RANGE – PREFERRED SIZES ARE SHADED

Case Size Soldering	0805				1206					1210						1808						1812									
	Reflow/Wave				Reflow/Wave					Reflow Only						Reflow Only						Reflow Only									
(L) Length	mm 2.10 ± 0.20 (in. (0.085 ± 0.008))				mm 3.30 ± 0.30 (in. (0.130 ± 0.012))					mm 3.30 ± 0.40 (in. (0.130 ± 0.016))						mm 4.60 ± 0.50 (in. (0.181 ± 0.020))						mm 4.60 ± 0.50 (in. (0.177 ± 0.012))									
(W) Width	mm 1.25 ± 0.20 (in. (0.049 ± 0.008))				mm 1.60 ± 0.30/-0.10 (in. (0.063 ± 0.012/-0.004))					mm 2.50 ± 0.30 (in. (0.098 ± 0.012))						mm 2.00 ± 0.20 (in. (0.079 ± 0.008))						mm 3.20 ± 0.30 (in. (0.126 ± 0.008))									
(T) Thickness	mm 1.35 (in. (0.053))				mm 1.80 (in. (0.071))					mm 2.80 (in. (0.110))						mm 2.20 (in. (0.087))						mm 2.80 (in. (0.100))									
(t) Terminal	mm 0.50 ± 0.20 (in. (0.020 ± 0.008))				mm 0.60 ± 0.20 (in. (0.04 ± 0.008))					mm 0.75 ± 0.35 (in. (0.030 ± 0.014))						mm 0.75 ± 0.35 (in. (0.030 ± 0.014))						mm 0.75 ± 0.35 (in. (0.030 ± 0.014))									
Voltage (V)	600	630	1000		600	630	1000	1500	2000	600	630	1000	1500	2000	3000	600	630	1000	1500	2000	2500	3000	4000	600	630	1000	1500	2000	2500	3000	4000
Cap (pF)	.5	OR5																													
	1.0	1R0	A	C																											
	1.2	1R2	A	C																											
	1.5	1R5	A	C	X	X	X	X	X																						
	1.8	1R8	A	C	X	X	X	X	X																						
	2.2	2R2	A	C	X	X	X	X	X							C	C		C			C	C								
	2.7	2R7	A	C	X	X	X	X	X							C	C	C	C	C	C	C	C								
	3.3	3R3	A	C	X	X	X	X	X							C	C	C	C	C	C	C	C								
	3.9	3R9	A	C	X	X	X	X	X							C	C	C	C	C	C	C	C								
	4.7	4R7	A	C	X	X	X	X	X							C	C	C	C	C	C	C	C								
	5.6	5R6	A	C	X	X	X	X	X							C	C	C	C	C	C	C	C								
	6.8	6R8	A	C	X	X	X	X	X							C	C	C	C	C	C	C	C								
	8.2	8R2	A	C	X	X	X	X	X							C	C	C	C	C	C	C	C								
	10	100	A	C	X	X	X	X	X	C	M	M	D	M	F	C	C	C	C	C	C	C	C	C	C	C	C	C	C	C	E
	12	120	A	C	X	X	X	X	X	C	M	M	D	M	F	C	C	C	C	C	C	C	C	C	C	C	C	C	C	C	E
	15	150	A	C	X	X	X	X	X	C	M	M	D	M	F	C	C	C	C	C	C	C	C	C	C	C	C	C	C	C	E
	18	180	A	C	X	X	X	X	X	C	M	M	D	M	F	C	C	C	C	C	C	C	C	C	C	C	C	C	C	C	E
	22	220	A	C	X	X	X	X	X	C	M	M	D	M	F	C	C	C	C	C	C	C	C	C	C	C	C	C	C	C	E
	27	270	A	C	X	X	X	X	X	C	M	M	D	M	F	C	C	C	C	C	C	C	C	C	C	C	C	C	C	C	E
	33	330	A	C	X	X	X	X	X	C	M	M	D	M	F	C	C	C	C	C	C	C	C	C	C	C	C	C	C	C	E
	39	390	A	C	X	X	X	X	X	C	M	M	D	M	F	C	C	C	C	C	C	C	C	C	C	C	C	C	C	C	E
	47	470	A	C	X	X	X	X	X	C	M	M	D	M	F	C	C	C	C	C	C	C	C	C	C	C	C	C	C	C	E
	56	560	A	C	X	X	X	X	X	C	M	M	D	M	F	C	C	C	C	C	C	C	C	C	C	C	C	C	C	C	E
	68	680	A	C	X	X	X	X	X	C	M	M	D	M	F	C	C	C	C	C	C	C	C	C	C	C	C	C	C	C	E
	82	820	X	X	X	X	X	X	X	C	M	M	D	M	F	C	C	C	C	C	C	C	C	C	C	C	C	C	C	C	E
	100	101	X	X	X	X	X	X	X	C	M	M	D	M	F	C	C	C	C	C	C	C	C	C	C	C	C	C	C	C	E
	120	121	C	C	X	X	X	X	X	C	M	M	D	M	F	C	C	C	C	C	C	C	C	C	C	C	C	C	C	C	E
	150	151	C	C	X	X	X	X	X	C	M	M	D	M	F	C	C	C	C	C	C	C	C	C	C	C	C	C	C	C	E
	180	181	C	C	X	X	X	X	X	C	M	M	D	M	F	C	C	C	C	C	C	C	C	C	C	C	C	C	C	C	E
	220	221	C	C	X	X	X	X	X	C	M	M	D	M	F	C	C	C	C	C	C	C	C	C	C	C	C	C	C	C	E
	270	271	C	C	C	M	E	E	E	C	M	E	E	E	E	G	C	F	C	F	F	F	F	C	C	C	C	F	F	F	F
	330	331	C	C	C	M	E	E	E	C	M	E	E	E	E		C	F	F	F	F	F	F	C	C	C	C	F	F	F	F
	390	391	C	C	C	M	E	E	E	C	M	E	E	E	E		C	F	F	F	F	F	F	C	C	C	C	F	F	F	F
	470	471	C	C	C	M	E	E	E	C	M	E	E	E	E		C	F	F	F	F	F	F	C	C	C	C	F	F	F	F
	560	561	C	C	C	C	E			C	M	E	E	E	E		C	F	F	F	F	F	F	C	C	C	C	F	F	F	F
	680	681	C	C	C	C	E			C	M	E	E	E	E		C	F	F	F	F	F	F	C	C	C	C	F	F	F	F
	750	751	C	C	E	E	E			C	M	E	G	E	E		C	F	F	F	F	F	F	C	C	C	C	F	F	F	F
	820	821	C	C	E	E	E			C	M	E	G	E	E		C	F	F	F	F	F	F	C	C	C	C	F	F	F	F
	1000	102	C	E	E	E	E			C	E	E	F	F	E		C	F	F	F	F	F	F	C	C	C	C	F	F	F	F
	1200	122	C	E	E	E	E			C	C	E	F	F	E		C	F	F	F	F	F	F	C	C	C	C	F	F	F	F
	1500	152	C	E	E	E	E			C	C	F	G	E	F		E	F	F	F	F	F	F	C	C	C	C	F	F	F	F
	1800	182	C	E	E	E	E			C	C	G	G	E	F		E	F	F	F	F	F	F	C	C	C	C	F	F	F	F
	2200	222	C	E	E	E	E			E	C	G	G	E	F		E	F	F	F	F	F	F	C	C	C	C	F	F	F	F
	2700	272	E	E	E	E	E			E	C	G	G	E	F		E	F	F	F	F	F	F	C	C	E	G	G			
	3300	332	E	E	E	E	E			E	C	G	G	E	F		E	F	F	F	F	F	F	C	C	F	G				
	3900	392	E	E	E	E	E			E	C	G	G	E	F		E	F	F	F	F	F	F	C	C	F	G				
	4700	472	E	E	E	E	E			E	C	G	G	E	F		E	F	F	F	F	F	F	C	C	G					
	5600	562	E	E	E	E	E			E	E						E	F	F	F	F	F	F	C	C	G					
	6800	682								E							F	F						E	C						
	8200	822								F							F	F						E	C						
Cap (µF)	0.010	103								F							F							E	C						
	0.012	123								G														F	F						
	0.015	153																						G	G						
	0.018	183																						G	G						
	0.022	223																						F							
	0.027	273																						G							
	0.033	333																						G							
	0.047	473																													
	0.056	563																													
	0.068	683																													
	0.100	104																													
Voltage (V)	600	630	1000		600	630	1000	1500	2000	600	630	1000	1500	2000	3000	600	630	1000	1500	2000	2500	3000	4								

MLC Chip Capacitors

High Voltage MLC Chips – For 600V to 5000V Applications



NP0 (C0G) CAPACITANCE RANGE – PREFERRED SIZES ARE SHADED

Case Size	1825								2220								2225								3640										
Soldering	Reflow Only								Reflow Only								Reflow Only								Reflow Only										
(L) Length	4.60 ± 0.50								5.70 ± 0.50								5.70 ± 0.50								9.14 ± 0.25										
(W) Width	6.30 ± 0.40								5.00 ± 0.40								6.30 ± 0.40								10.2 ± 0.25										
(T) Thickness	3.40								3.40								3.40								2.54										
(t) Terminal	0.75 ± 0.35								0.85 ± 0.35								0.85 ± 0.35								0.76 (0.030)										
Cap (pF)	0.134								0.134								0.100								0.100										
Cap (µF)	0.030 ± 0.014								0.033 ± 0.014								0.033 ± 0.014								1.52 (0.060)										
Voltage (V)	600	630	1000	1500	2000	2500	3000	4000	600	630	1000	1500	2000	2500	3000	4000	5000	600	630	1000	1500	2000	2500	3000	4000	5000	600	630	1000	1500	2000	2500	3000	4000	5000
1.5 1R5																																			
1.8 1R8																																			
2.2 2F2																																			
2.7 2F7																																			
3.3 3F3																																			
3.9 3F9																																			
4.7 4F7																																			
5.6 5F6																																			
6.8 6F8																																			
8.2 8F2																																			
10 100	E	E	G	E	F	E	F	F	E	E	E	E	E	E	E	E	E	E	E	E	E	E	E	E	F	F									
12 120	E	E	G	E	F	E	F	F	E	E	E	E	E	E	E	E	E	E	E	E	E	E	E	E	F	F									
15 150	E	E	G	E	F	E	F	F	E	E	E	E	E	E	E	E	E	E	E	E	E	E	E	E	F	F									
18 180	E	E	G	E	F	E	F	F	E	E	E	E	E	E	E	E	E	E	E	E	E	E	E	E	F	F									
22 220	E	E	G	E	F	E	F	F	E	E	E	E	E	E	E	E	E	E	E	E	E	E	E	E	F	F									
27 270	E	E	G	E	F	E	F	F	E	E	E	E	E	E	E	E	E	E	E	E	E	E	E	E	F	F									
33 330	E	E	G	E	F	E	F	F	E	E	E	E	E	E	E	E	E	E	E	E	E	E	E	E	F	F									
39 390	E	E	G	E	F	E	F	F	E	E	E	E	E	E	E	E	E	E	E	E	E	E	E	E	F	F									
47 470	E	E	G	E	F	E	F	F	E	E	E	E	E	E	E	E	E	E	E	E	E	E	E	E	F	F							G		
56 560	E	E	G	E	F	E	F	F	E	E	E	E	E	E	E	E	E	E	E	E	E	E	E	E	F	G							G		
68 680	E	E	G	E	F	E	F	F	E	E	E	E	E	E	E	E	E	E	E	E	E	E	E	E	F	G							G		
82 820	E	E	G	E	F	E	F	F	E	E	E	E	E	E	E	E	E	E	E	E	E	E	E	E	F	G							G		
100 101	E	E	G	E	F	E	F	F	E	E	E	E	E	E	E	E	E	E	E	E	E	E	E	E	G								G		
120 121	E	E	G	E	F	E	F	F	E	E	E	E	E	E	E	E	E	E	E	E	E	E	E	E	G								G		
150 151	E	E	G	E	F	E	F	F	E	E	E	E	E	E	E	E	E	E	E	E	E	E	E	E	G								G		
180 181	E	E	G	E	F	E	F	F	E	E	E	E	E	E	E	E	E	E	E	E	E	E	E	E	G								G		
220 221	E	E	G	E	F	E	F	F	E	E	E	E	E	E	E	E	E	E	E	E	E	E	E	E	G								G		
270 271	E	E	G	E	F	E	F	F	E	E	E	E	E	E	E	E	E	E	E	E	E	E	E	E	G								G		
330 331	E	E	G	E	F	E	F	F	E	E	E	E	E	E	E	E	E	E	E	E	E	E	E	E	G								G		
390 391	E	E	G	E	F	E	F	F	E	E	E	E	E	E	E	E	E	E	E	E	E	E	E	E	G								G		
470 471	E	E	G	E	F	E	F	F	E	E	E	E	E	E	E	E	E	E	E	E	E	E	E	E	G								G		
560 561	E	E	G	E	F	E	F	F	E	E	E	E	E	E	E	E	E	E	E	E	E	E	E	E	G								G		
680 681	E	E	G	E	F	E	F	F	E	E	E	E	E	E	E	E	E	E	E	E	E	E	E	E	G								G		
750 751	E	E	G	E	F	E	F	F	E	E	E	E	E	E	E	E	E	E	E	E	E	E	E	E	G								G		
820 821	E	E	G	E	F	E	F	F	E	E	E	E	E	E	E	E	E	E	E	E	E	E	E	E	G								G		
1000 102	E	E	G	E	F	E	F	F	E	E	E	E	E	E	E	E	E	E	E	E	E	E	E	E	G								G		
1200 122	E	E	G	E	F	E	F	F	E	E	E	E	E	E	E	E	E	E	E	E	E	E	E	E	G								G		
1500 152	E	E	G	E	F	E	F	F	E	E	E	E	E	E	E	E	E	E	E	E	E	E	E	E	G								G		
1800 182	E	E	G	E	F	E	F	F	E	E	E	E	E	E	E	E	E	E	E	E	E	E	E	E	G								G		
2200 222	E	E	G	E	F	E	F	F	E	E	E	E	E	E	E	E	E	E	E	E	E	E	E	E	G								G		
2700 272	E	E	G	E	F	E	F	F	E	E	E	E	E	E	E	E	E	E	E	E	E	E	E	E	G								G		
3300 332	E	E	G	E	F	E	F	F	E	E	E	E	E	E	E	E	E	E	E	E	E	E	E	E	G								G		
3900 392	E	E	G	E	F	E	F	F	E	E	E	E	E	E	E	E	E	E	E	E	E	E	E	E	G								G		
4700 472	E	E	G	E	F	E	F	F	E	E	E	E	E	E	E	E	E	E	E	E	E	E	E	E	G								G		
5600 562	F	F	G	E	F	E	F	F	E	E	E	E	E	E	E	E	E	E	E	E	E	E	E	E	G								G		
6800 682	F	F	G	E	F	E	F	F	E	E	E	E	E	E	E	E	E	E	E	E	E	E	E	E	G								G		
8200 822	G	G	G	E	F	E	F	F	E	E	E	E	E	E	E	E	E	E	E	E	E	E	E	E	G								G		
Cap (µF) 0.010 103	F	E	G						7	7	7														G										
0.012 123		E	G																						G										
0.015 153		E																							G										
0.018 183		E																							G										
0.022 223		E																							G										
0.027 273		F																							G										
0.033 333		F																							G										
0.039 393		G																							G										
0.047 473		G																							G										
0.056 563		G																							G										
0.068 683		G																							G										
0.100 104																									G										
Voltage (V)	600	630	1000	1500	2000	2500	3000	4000	600	630	1000	1500	2000	2500	3000	4000	5000	600	630	1000	1500	2000	2500	3000	4000	5000	600	630	1000	1500	2000	2500	3000	4000	5000
Case Size	1825								2220								2225								3640										

Letter	A	C	E	F	G	X	7
Max. Thickness	0.813 (0.032)	1.448 (0.057)	1.8034 (0.071)	2.2098 (0.087)	2.794 (0.110)	0.940 (0.037)	3.30 (0.130)

NOTE: Contact factory for non-specified capacitance values



MLC Chip Capacitors

High Voltage MLC Chips – For 600V to 5000V Applications



X7R Dielectric

Performance Characteristics

Capacitance Range	10 pF to 0.82 µF (25°C, 1.0 ±0.2 Vrms at 1kHz)
Capacitance Tolerances	±10%; ±20%; +80%, -20%
Dissipation Factor	2.5% max. (+25°C, 1.0 ±0.2 Vrms, 1kHz)
Operating Temperature Range	-55°C to +125°C
Temperature Characteristic	±15% (0 VDC)
Voltage Ratings	600, 630, 1000, 1500, 2000, 2500, 3000, 4000 & 5000 VDC (+125°C)
Insulation Resistance (+25°C, at 500 VDC)	100K MΩ min. or 1000 MΩ - µF min., whichever is less
Insulation Resistance (+125°C, at 500 VDC)	10K MΩ min. or 100 MΩ - µF min., whichever is less
Dielectric Strength	Minimum 120% rated voltage for 5 seconds at 50 mA max. current

X7R CAPACITANCE RANGE – PREFERRED SIZES ARE SHADED

Case Size Soldering	0805			1206					1210					1808								1812							
	Reflow/Wave			Reflow/Wave					Reflow Only					Reflow Only								Reflow Only							
(L) Length	2.10 0.20 (0.085 ± 0.008)			3.30 ± 0.30 (0.130 ± 0.012)					3.30 0.40 (0.130 0.016)					4.60 ± 0.50 (0.181 ± 0.020)								4.60 ± 0.50 (0.177 ± 0.012)							
(W) Width	1.25 ± 0.20 (0.049 ± 0.008)			1.60 ± 0.30/-0.10 (0.063 ± 0.012/-0.004)					2.50 0.30 (0.099 0.012)					2.00 0.20 (0.079 ± 0.008)								3.20 ± 0.30 (0.126 ± 0.008)							
(T) Thickness	1.35 (0.053)			1.80 (0.071)					2.80 (0.110)					2.20 (0.087)								2.80 (0.100)							
(t) Terminal	0.50 ± 0.20 (0.020 ± 0.008)			0.60 ± 0.20 (0.024 ± 0.008)					0.75 0.35 (0.030 ± 0.014)					0.75 ± 0.35 (0.030 ± 0.014)								0.75 ± 0.35 (0.030 ± 0.014)							
Voltage (V)	600	630	1000	600	630	1000	1500	2000	600	630	1000	1500	2000	600	630	1000	1500	2000	2500	3000	4000	600	630	1000	1500	2000	2500	3000	4000
Cap (pF)	100	101	X	X	C	C	C	E	E	E	E	E	E	E	E	E	E	E	E	E	F								
	120	121	X	X	C	C	C	E	E	E	E	E	E	E	E	E	E	E	E	E	F								
	150	151	X	X	C	C	C	E	E	E	E	E	E	E	E	E	E	E	E	E	F								
	180	181	X	X	C	C	C	E	E	E	E	E	E	E	E	E	E	E	E	E	F								
	220	221	X	X	C	C	C	E	E	E	E	E	E	E	E	E	E	E	E	E	F								
	270	271	X	X	C	C	C	E	E	E	E	E	E	E	E	E	E	E	E	E	F			E	E	E	E	E	E
	330	331	X	X	C	C	C	E	E	E	E	E	E	E	E	E	E	E	E	E	F			E	E	E	E	E	E
	390	391	X	X	C	C	C	E	E	E	E	E	E	E	E	E	E	E	E	E	F			E	E	E	E	E	E
	470	471	X	X	C	C	C	E	E	E	E	E	E	E	E	E	E	E	E	E	F			E	E	E	E	E	E
	560	561	X	X	C	C	C	E	E	E	E	E	E	E	E	E	E	E	E	E	F			E	E	E	E	E	E
	680	681	X	X	C	C	C	E	E	E	E	E	E	E	E	E	E	E	E	F			E	E	E	E	E	F	F
	750	751	X	X	C	C	C	E	E	E	E	E	E	E	E	E	E	E	E	F			E	E	E	E	E	F	F
	820	821	X	X	C	C	C	E	E	E	E	E	E	E	E	E	E	E	E	F			E	E	E	E	E	F	F
	1000	102	X	X	C	C	C	E	E	E	E	E	E	E	E	E	E	E	E	F			E	E	E	E	E	F	F
	1200	122	X	X	X	C	C	E	E	E	E	E	E	E	E	E	E	E	E	F			F	F	F	F	F	F	F
	1500	152	X	X	X	C	C	E	E	E	E	E	E	E	E	E	E	E	E	F			F	F	F	F	F	G	G
	1800	182	X	X	X	C	C	E	E	E	E	E	E	E	E	E	E	E	E	F			F	F	F	F	F	G	G
	2200	222	X	X	X	C	C	E	E	E	E	E	E	E	E	E	E	E	F			F	F	F	F	F	G	G	
	2700	272	C	C		C	C	E	E		E	E	E	F	E	E	E	E	F	F			F	F	F	F	F	G	G
	3300	332	C	C		C	C	E			E	E	E	F	E	E	E	F	F			F	F	F	F	F	G	G	
	3900	392	C	C		C	C	E			E	E	E	F		E	E	E	F			F	F	F	F	F	G	G	
	4700	472	C	C		C	C	E			E	E	E	F		E	E	E	F			F	F	F	F	F	G	G	
	5600	562	C	C		C	C	E			E	E	E	F		E	E	E	F			F	F	F	G	G	G	G	
	6800	682	C	C		C	C	E			E	E	E			E	E	E	F			F	F	F	G	G			
	8200	822	C	C		C	C	E			E	E	E			E	E	E				F	F	F	G	G			
Cap (µF)	0.010	103	C	C		C	C	E			E	E	E			E	E	E				F	F	F	G	G			
	0.015	153	C	C		E	E	E			E	E	E			F	F	F				F	F	F	G				
	0.018	183	C	C		E	E				E	E	E			F	F	F				F	F	G					
	0.022	223	C	C		E	E				E	E	F			F	F					F	F	G					
	0.027	273				E	E				E	E				F	F					F	F	G					
	0.033	333				E	E				E	E				F	F					F	F	G					
	0.039	393				E	E				E	E				F	F					F	F	G					
	0.047	473				E	E				E	E				F	F					F	F	G					
	0.056	563				F	F				F	F				F	F					F	F						
	0.068	683				F	F				F	F				F	F					F	F						
	0.082	823				F	F				F	F				F	F					F	F						
	0.100	104				F	F				F	F				F	F					F	F						
	0.150	154																							G	G			
	0.220	224																							G	G			
	0.270	274																											
	0.330	334																											
	0.390	394																											
	0.470	474																											
	0.560	564																											
	0.680	684																											
	0.820	824																											
	1.000	105																											
Voltage (V)	600	630	1000	600	630	1000	1500	2000	600	630	1000	1500	2000	600	630	1000	1500	2000	2500	3000	4000	600	630	1000	1500	2000	2500	3000	4000
Case Size	0805			1206					1210					1808								1812							

Letter	A	C	E	F	G	X	7
Max. Thickness	0.813 (0.032)	1.448 (0.057)	1.8034 (0.071)	2.2098 (0.087)	2.794 (0.110)	0.940 (0.037)	3.30 (0.130)

NOTE: Contact factory for non-specified capacitance values



The Important Information/Disclaimer is incorporated in the catalog where these specifications came from or available online at www.avx.com/disclaimer/ by reference and should be reviewed in full before placing any order.

MLC Chip Capacitors

High Voltage MLC Chips – For 600V to 5000V Applications



X7R CAPACITANCE RANGE PREFERRED SIZES ARE SHADED

Case Size	1825								2220								2225								3640																					
	Soldering								Soldering								Soldering								Soldering																					
(L) Length	4.60 ± 0.50								5.70 ± 0.50								5.70 ± 0.50								9.14 ± 0.25																					
(W) Width	6.30 ± 0.40								5.00 ± 0.40								6.30 ± 0.40								10.2 ± 0.25																					
(T) Thickness	3.40								3.40								3.40								2.54																					
(t) Terminal max	0.75 ± 0.35								0.85 ± 0.35								0.85 ± 0.35								0.76 (0.030)																					
Cap (pF)	100								100								100								100																					
Voltage (V)	600	630	1000	1500	2000	2500	3000	4000	600	630	1000	1500	2000	2500	3000	4000	5000	600	630	1000	1500	2000	2500	3000	4000	5000	600	630	1000	1500	2000	2500	3000	4000	5000											
100																																														
120																																														
150																																														
180																																														
220																																														
270																																														
330																																														
390																																														
470																																														
560																																														
680																																														
750																																														
820																																														
1000	F	F	F	F	F	F	F	F	F	F	F	F	F	F	F	F	F	F	F	F	F	F	F	F	F	F	F	F	F	F	F	F	F	F	F	G	G	G	G	G	G	G	G	G		
1200	F	F	F	F	F	F	F	F	F	F	F	F	F	F	F	F	F	F	F	F	F	F	F	F	F	F	F	F	F	F	F	F	F	F	F	F	G	G	G	G	G	G	G	G	G	
1500	F	F	F	F	F	F	F	F	F	F	F	F	F	F	F	F	F	F	F	F	F	F	F	F	F	F	F	F	F	F	F	F	F	F	F	F	G	G	G	G	G	G	G	G	G	
1800	F	F	F	F	F	F	F	F	F	F	F	F	F	F	F	F	F	F	F	F	F	F	F	F	F	F	F	F	F	F	F	F	F	F	F	F	G	G	G	G	G	G	G	G	G	
2200	F	F	F	F	F	F	F	F	F	F	F	F	F	F	F	F	F	F	F	F	F	F	F	F	F	F	F	F	F	F	F	F	F	F	F	F	G	G	G	G	G	G	G	G	G	
2700	F	F	F	F	F	F	F	F	F	F	F	F	F	F	F	F	F	F	F	F	F	F	F	F	F	F	F	F	F	F	F	F	F	F	F	F	G	G	G	G	G	G	G	G	G	
3300	F	F	F	F	F	F	F	F	F	F	F	F	F	F	F	F	F	F	F	F	F	F	F	F	F	F	F	F	F	F	F	F	F	F	F	F	G	G	G	G	G	G	G	G	G	
3900	F	F	F	F	F	F	F	F	F	F	F	F	F	F	F	F	F	F	F	F	F	F	F	F	F	F	F	F	F	F	F	F	F	F	F	F	G	G	G	G	G	G	G	G	G	
4700	F	F	F	F	F	F	F	F	F	F	F	F	F	F	F	F	F	F	F	F	F	F	F	F	F	F	F	F	F	F	F	F	F	F	F	F	G	G	G	G	G	G	G	G	G	
5600	F	F	F	F	F	F	F	F	F	F	F	F	F	F	F	F	F	F	F	F	F	F	F	F	F	F	F	F	F	F	F	F	F	F	F	F	G	G	G	G	G	G	G	G	G	
6800	F	F	F	G	G	G	G	G	F	F	F	F	F	F	F	F	F	F	F	F	F	F	F	F	F	F	F	F	F	F	F	F	F	F	F	F	F	G	G	G	G	G	G	G	G	G
8200	F	F	F	G	G	G	G	G	F	F	F	G	G	G	G	F	F	F	F	F	F	F	F	F	F	F	F	F	F	F	F	F	F	F	F	F	F	G	G	G	G	G	G	G	G	G
Cap (µF)	0.010	0.010	F	F	F	F	F	F	F	F	F	F	F	F	F	F	F	F	F	F	F	F	F	F	F	F	F	F	F	F	F	F	F	F	F	G	G	G	G	G	G	G	G	G		
0.015	0.015	F	F	F	G	G	G	G	F	F	F	G	G	G	G	F	F	F	G	G	G	G	G	G	G	G	G	G	G	G	G	G	G	G	G	G	G	G	G	G	G	G	G	G	G	
0.018	0.018	F	F	F	F	G	G	G	F	F	F	F	F	F	F	F	F	F	F	F	F	F	F	F	F	F	F	F	F	F	F	F	F	F	F	F	G	G	G	G	G	G	G	G	G	
0.022	0.022	F	F	F	G	G	G	G	F	F	F	G	G	G	G	F	F	F	F	F	F	F	F	F	F	F	F	F	F	F	F	F	F	F	F	F	G	G	G	G	G	G	G	G	G	
0.027	0.027	F	F	F	G	G	G	G	F	F	F	F	F	F	F	F	F	F	F	F	F	F	F	F	F	F	F	F	F	F	F	F	F	F	F	F	G	G	G	G	G	G	G	G	G	
0.033	0.033	F	F	F	G	G	G	G	F	F	F	F	F	F	F	F	F	F	F	F	F	F	F	F	F	F	F	F	F	F	F	F	F	F	F	F	G	G	G	G	G	G	G	G	G	
0.039	0.039	F	F	F	G	G	G	G	F	F	F	F	F	F	F	F	F	F	F	F	F	F	F	F	F	F	F	F	F	F	F	F	F	F	F	F	G	G	G	G	G	G	G	G	G	
0.047	0.047	F	F	F	P				F	F	F	F	F	F	F	F	F	F	F	F	F	F	F	F	F	F	F	F	F	F	F	F	F	F	F	F	G	G	G	G	G	G	G	G	G	
0.056	0.056	F	F	F	G				F	F	F	F	F	F	F	F	F	F	F	F	F	F	F	F	F	F	F	F	F	F	F	F	F	F	F	F	G	G	G	G	G	G	G	G	G	
0.068	0.068	F	F	F	G				F	F	F	F	F	F	F	F	F	F	F	F	F	F	F	F	F	F	F	F	F	F	F	F	F	F	F	F	G	G	G	G	G	G	G	G	G	
0.082	0.082	F	F	F	G				F	F	F	F	F	F	F	F	F	F	F	F	F	F	F	F	F	F	F	F	F	F	F	F	F	F	F	F	G	G	G	G	G	G	G	G	G	
0.100	0.100	F	F	F	G				F	F	F	F	F	F	F	F	F	F	F	F	F	F	F	F	F	F	F	F	F	F	F	F	F	F	F	F	G	G	G	G	G	G	G	G	G	
0.150	0.150	F	F						F	F	F	F	F	F	F	F	F	F	F	F	F	F	F	F	F	F	F	F	F	F	F	F	F	F	F	F	G	G	G	G	G	G	G	G	G	
0.220	0.220	F	F						F	F	F	F	F	F	F	F	F	F	F	F	F	F	F	F	F	F	F	F	F	F	F	F	F	F	F	F	G	G	G	G	G	G	G	G	G	
0.270	0.270	F	F						F	F	F	F	F	F	F	F	F	F	F	F	F	F	F	F	F	F	F	F	F	F	F	F	F	F	F	F	G	G	G	G	G	G	G	G	G	
0.330	0.330	F	F						F	F	F	F	F	F	F	F	F	F	F	F	F	F	F	F	F	F	F	F	F	F	F	F	F	F	F	F	G	G	G	G	G	G	G	G	G	
0.390	0.390	F	F						F	F	F	F	F	F	F	F	F	F	F	F	F	F	F	F	F	F	F	F	F	F	F	F	F	F	F	F	G	G	G	G	G	G	G	G	G	
0.470	0.470	F	F						F	F	F	F	F	F	F	F	F	F	F	F	F	F	F	F	F	F	F	F	F	F	F	F	F	F	F	F	G	G	G	G	G	G	G	G	G	
0.560	0.560	G	G						G	G	G	G	G	G	F	F	F	F	F	F	F	F	F	F	F	F	F	F	F	F	F	F	F	F	F	F	G	G	G	G	G	G	G	G	G	
0.680	0.680								G	G	G	G	G	G	F	F	F	F	F	F	F	F	F	F	F	F	F	F	F	F	F	F	F	F	F	F	F	G	G	G	G	G	G	G	G	G
0.820	0.820															G	G	G	G	G	G	G	G	G	G	G	G	G	G	G	G	G	G	G	G											
1.000	1.000															G	G	G	G	G	G	G	G	G	G	G	G	G	G	G	G	G	G	G	G											
Voltage (V)	600	630	1000	1500	2000	2500	3000	4000	600	630	1000	1500	2000	2500	3000	4000	5000	600	630	1000	1500	2000	2500	3000	4000	5000	600																			

MLC Chip Capacitors

High Voltage MLC Chips Tin/Lead Termination "B"

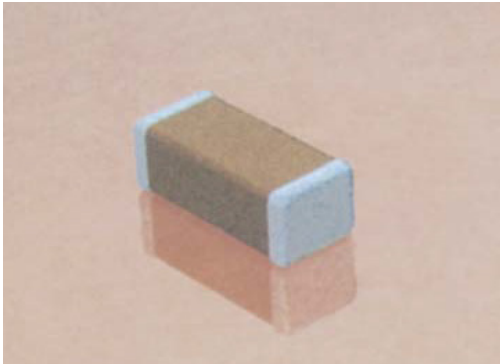

NEW 630V RANGE

AVX Corporation will support those customers for commercial and military Multilayer Ceramic Capacitors with a termination consisting of 5% minimum lead. This termination is indicated by the use of a "B" in the 12th position of the AVX Catalog Part Number. This fulfills AVX's commitment to providing a full range of products to our customers. AVX has provided in the following pages, a full range of values that we are offering in this "B" termination.

Larger physical sizes than normally encountered chips are used to make high voltage MLC chip product. Special precautions must be taken in applying these chips in surface mount assemblies. The temperature gradient during heating or cooling cycles should not exceed 4°C per second. The preheat temperature must be within 50°C of the peak temperature reached by the ceramic bodies through the soldering process. Chip sizes 1210 and larger should be reflow soldered only. Capacitors may require protective surface coating to prevent external arcing.

For 1825, 2225 and 3640 sizes, AVX offers leaded version in either thru-hole or SMT configurations (for details see section on high voltage leaded MLC chips).

HOW TO ORDER

1808	A	A	271	K	A	B	1	A
AVX Style	Voltage	Temperature Coefficient	Capacitance Code (2 significant digits + no. of zeros)	Capacitance Tolerance	Test Level	Termination*	Packaging	Special Code
LD05 - 0805 LD06 - 1206 LD10 - 1210 LD08 - 1808 LD12 - 1812 LD13 - 1825 LD20 - 2220 LD14 - 2225 LD40 - 3640	600V/630V = C 1000V = A 1500V = S 2000V = G 2500V = W 3000V = H 4000V = J 5000V = K	COG = A X7R = C	Examples: 10 pF = 100 100 pF = 101 1,000 pF = 102 22,000 pF = 223 220,000 pF = 224 1 μF = 105	C0G: J = ±5% K = ±10% M = ±20% X7R: K = ±10% M = ±20% Z = +80%, -20%	A = Standard	B = 5% Min Pb X = FLEXITERM with 5% Pb*	2 = 7" Reel** 1 = 13" Reel	A = Standard

Notes: Capacitors with X7R dielectrics are not intended for applications across AC supply mains or AC line filtering with polarity reversal. Contact plant for recommendations. Contact factory for availability of Termination and Tolerance options for Specific Part Numbers.

* FLEXITERM is not available in the LD40 Style

** The LD40 Style is not available on 7" Reels.

*** AVX offers nonstandard chip sizes. Contact factory for details.

Not RoHS Compliant

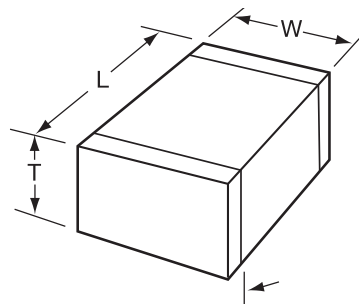

DIMENSIONS

millimeters (inches)

SIZE	LD05 (0805)	LD06 (1206)	LD10* (1210)	LD08* (1808)	LD12* (1812)	LD13* (1825)	LD20* (2220)	LD14* (2225)	LD40* (3640)
(L) Length	2.10 ± 0.20 (0.083 ± 0.008)	3.30 ± 0.30 (0.130 ± 0.012)	3.30 ± 0.40 (0.130 ± 0.016)	4.60 ± 0.50 (0.181 ± 0.020)	4.60 ± 0.50 (0.181 ± 0.020)	4.60 ± 0.50 (0.181 ± 0.020)	5.70 ± 0.50 (0.224 ± 0.020)	5.70 ± 0.50 (0.224 ± 0.020)	9.14 ± 0.25 (0.360 ± 0.010)
(W) Width	1.25 ± 0.20 (0.049 ± 0.008)	1.60 ^{+0.30} _{-0.10} (0.063 ^{+0.012} _{-0.004})	2.50 ± 0.30 (0.098 ± 0.012)	2.00 ± 0.20 (0.079 ± 0.008)	3.20 ± 0.30 (0.126 ± 0.012)	6.30 ± 0.40 (0.248 ± 0.016)	5.00 ± 0.40 (0.197 ± 0.016)	6.30 ± 0.40 (0.248 ± 0.016)	10.2 ± 0.25 (0.400 ± 0.010)
(T) Thickness	1.35 (0.053)	1.80 (0.071)	2.80 (0.110)	2.20 (0.087)	2.80 (0.110)	3.40 (0.134)	3.40 (0.134)	3.40 (0.134)	2.54 (0.100)
(t) terminal	min. 0.50 ± 0.20 max. (0.020 ± 0.008)	0.60 ± 0.20 (0.024 ± 0.008)	0.75 ± 0.35 (0.030 ± 0.014)	0.75 ± 0.35 (0.030 ± 0.014)	0.75 ± 0.35 (0.030 ± 0.014)	0.75 ± 0.35 (0.030 ± 0.014)	0.85 ± 0.35 (0.033 ± 0.014)	0.85 ± 0.35 (0.033 ± 0.014)	0.76 (0.030) 1.52 (0.060)

*Reflow Soldering Only

Performance of SMPS capacitors can be simulated by downloading SpiCalci software program -
<http://www.avx.com/download/software/SpiCalci-AVX.zip>
 Custom values, ratings and configurations are also available.

MLC Chip Capacitors

High Voltage MLC Chips Tin/Lead Termination "B"



COG Dielectric

Performance Characteristics

Capacitance Range	10 pF to 0.047 μF (25°C, 1.0 ±0.2 Vrms at 1kHz, for ≤ 1000 pF use 1 MHz)
Capacitance Tolerances	±5%, ±10%, ±20%
Dissipation Factor	0.1% max. (+25°C, 1.0 ±0.2 Vrms, 1kHz, for ≤ 1000 pF use 1 MHz)
Operating Temperature Range	-55°C to +125°C
Temperature Characteristic	0 ±30 ppm/°C (0 VDC)
Voltage Ratings	600, 630, 1000, 1500, 2000, 2500, 3000, 4000 & 5000 VDC (+125°C)
Insulation Resistance (+25°C, at 500 VDC)	100K MΩ min. or 1000 MΩ - μF min., whichever is less
Insulation Resistance (+125°C, at 500 VDC)	10K MΩ min. or 100 MΩ - μF min., whichever is less
Dielectric Strength	Minimum 120% rated voltage for 5 seconds at 50 mA max. current

HIGH VOLTAGE COG CAPACITANCE VALUES

VOLTAGE	LD05 (0805)	LD06 (1206)	LD10 (1210)	LD08 (1808)	LD12 (1812)	LD13 (1825)	LD20 (2220)	LD14 (2225)	LD40 (3640)
600/630	min.	10pF	10 pF	100 pF	100 pF	100 pF	1000 pF	1000 pF	1000 pF
	max.	330pF	1200 pF	2700 pF	3300 pF	5600 pF	0.012 μF	0.012 μF	0.018 μF
1000	min.	10pF	10 pF	10 pF	100 pF	100 pF	100 pF	1000 pF	1000 pF
	max.	180pF	560 pF	1500 pF	2200 pF	3300 pF	8200 pF	0.010 μF	0.010 μF
1500	min.	—	10 pF	10 pF	10 pF	10 pF	100 pF	100 pF	100 pF
	max.	—	270 pF	680 pF	820 pF	1800 pF	4700 pF	4700 pF	5600 pF
2000	min.	—	10 pF	10 pF	10 pF	10 pF	100 pF	100 pF	100 pF
	max.	—	120 pF	270 pF	330 pF	1000 pF	1800 pF	2200 pF	2700 pF
2500	min.	—	—	—	10 pF	10 pF	10 pF	100 pF	100 pF
	max.	—	—	—	180 pF	470 pF	1200 pF	1500 pF	1800 pF
3000	min.	—	—	—	10 pF	10 pF	10 pF	10 pF	100 pF
	max.	—	—	—	120 pF	330 pF	820 pF	1000 pF	1200 pF
4000	min.	—	—	—	10 pF	10 pF	10 pF	10 pF	100 pF
	max.	—	—	—	47 pF	150 pF	330 pF	470 pF	560 pF
5000	min.	—	—	—	—	—	—	10 pF	10 pF
	max.	—	—	—	—	—	—	220 pF	270 pF

X7R Dielectric

Performance Characteristics

Capacitance Range	10 pF to 0.56 μF (25°C, 1.0 ±0.2 Vrms at 1kHz)
Capacitance Tolerances	±10%; ±20%; +80%, -20%
Dissipation Factor	2.5% max. (+25°C, 1.0 ±0.2 Vrms, 1kHz)
Operating Temperature Range	-55°C to +125°C
Temperature Characteristic	±15% (0 VDC)
Voltage Ratings	600, 630, 1000, 1500, 2000, 2500, 3000, 4000 & 5000 VDC (+125°C)
Insulation Resistance (+25°C, at 500 VDC)	100K MΩ min. or 1000 MΩ - μF min., whichever is less
Insulation Resistance (+125°C, at 500 VDC)	10K MΩ min. or 100 MΩ - μF min., whichever is less
Dielectric Strength	Minimum 120% rated voltage for 5 seconds at 50 mA max. current

HIGH VOLTAGE X7R MAXIMUM CAPACITANCE VALUES

VOLTAGE	0805	1206	1210	1808	1812	1825	2220	2225	3640
600/630	min.	100pF	1000 pF	1000 pF	1000 pF	1000 pF	0.010 μF	0.010 μF	0.010 μF
	max.	6800pF	0.022 μF	0.056 μF	0.068 μF	0.120 μF	0.270 μF	0.270 μF	0.330 μF
1000	min.	100pF	100 pF	1000 pF	1000 pF	1000 pF	1000 pF	1000 pF	1000 pF
	max.	1500pF	6800 pF	0.015 μF	0.018 μF	0.039 μF	0.100 μF	0.120 μF	0.150 μF
1500	min.	—	100 pF	100 pF	100 pF	100 pF	1000 pF	1000 pF	1000 pF
	max.	—	2700 pF	5600 pF	6800 pF	0.015 μF	0.056 μF	0.056 μF	0.068 μF
2000	min.	—	10 pF	100 pF	100 pF	100 pF	1000 pF	1000 pF	1000 pF
	max.	—	1500 pF	3300 pF	3300 pF	8200 pF	0.022 μF	0.027 μF	0.033 μF
2500	min.	—	—	—	10 pF	10 pF	100 pF	100 pF	1000 pF
	max.	—	—	—	2200 pF	5600 pF	0.015 μF	0.018 μF	0.022 μF
3000	min.	—	—	—	10 pF	10 pF	100 pF	100 pF	1000 pF
	max.	—	—	—	1800 pF	3900 pF	0.010 μF	0.012 μF	0.015 μF
4000	min.	—	—	—	—	—	—	—	100 pF
	max.	—	—	—	—	—	—	—	6800 pF
5000	min.	—	—	—	—	—	—	—	100 pF
	max.	—	—	—	—	—	—	—	3300 pF

MLC Chip Capacitors

High Voltage MLC Chips FLEXITERM®

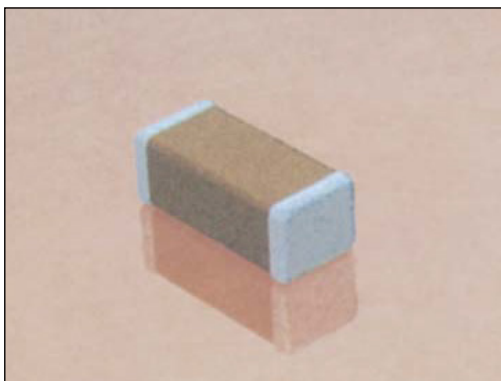

High value, low leakage and small size are difficult parameters to obtain in capacitors for high voltage systems. AVX special high voltage MLC chips capacitors meet these performance characteristics and are designed for applications such as snubbers in high frequency power converters, resonators in SMPS, and high voltage coupling/DC blocking. These high voltage chip designs exhibit low ESRs at high frequencies.

To make high voltage chips, larger physical sizes than are normally encountered are necessary. These larger sizes require that special precautions be taken in applying these chips in surface mount assemblies. In response to this, and to follow from the success of the FLEXITERM® range of low voltage parts, AVX is delighted to offer a FLEXITERM® high voltage range of capacitors, FLEXITERM®.

The FLEXITERM® layer is designed to enhance the mechanical flexure and temperature cycling performance of a standard ceramic capacitor, giving customers a solution where board flexure or temperature cycle damage are concerns.

HOW TO ORDER

1808	A	C	272	K	A	Z	1	A
AVX Style	Voltage	Temperature Coefficient	Capacitance Code (2 significant digits + no. of zeros)	Capacitance Tolerance	Test Level	Termination*	Packaging	Special Code
0805	600V/630V = C	COG = A	Examples:	COG:J = ±5%		Z = FLEXITERM® 2 = 7" Reel**	Tin4 = 13" Reel	A = Standard
1206	1000V = A	X7R = C	10 pF = 100	K = ±10%		100% (RoHS Compliant)		
1210	1500V = S		100 pF = 101	M = ±20%				
1808	2000V = G		1,000 pF = 102	X7R:K = ±10%				
1812	2500V = W		22,000 pF = 223	M = ±20%				
1825	3000V = H		220,000 pF = 224	Z = +80%, -20%				
2220	4000V = J		1 μF = 105					
2225	5000V = K							

Notes: Capacitors with X7R dielectrics are not intended for applications across AC supply mains or AC line filtering with polarity reversal. Contact plant for recommendations. Contact factory for availability of Termination and Tolerance options for Specific Part Numbers.

*** AVX offers nonstandard chip sizes. Contact factory for details.

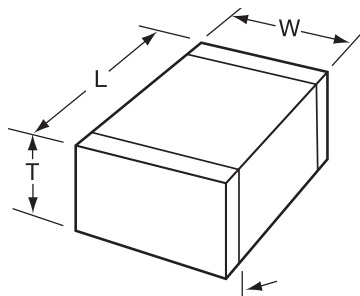

DIMENSIONS

SIZE	0805	1206	1210*	1808*	1812*	1825*	2220*	2225*
(L) Length	2.10 ± 0.20 (0.083 ± 0.008)	3.30 ± 0.30 (0.130 ± 0.012)	3.30 ± 0.40 (0.130 ± 0.016)	4.60 ± 0.50 (0.181 ± 0.020)	4.60 ± 0.50 (0.181 ± 0.020)	4.60 ± 0.50 (0.181 ± 0.020)	5.70 ± 0.50 (0.224 ± 0.020)	5.70 ± 0.50 (0.224 ± 0.020)
(W) Width	1.25 ± 0.20 (0.049 ± 0.008)	1.60 ^{+0.30} _{-0.10} (0.063 ^{+0.012} _{-0.004})	2.50 ± 0.30 (0.098 ± 0.012)	2.00 ± 0.20 (0.079 ± 0.008)	3.20 ± 0.30 (0.126 ± 0.012)	6.30 ± 0.40 (0.248 ± 0.016)	5.00 ± 0.40 (0.197 ± 0.016)	6.30 ± 0.40 (0.248 ± 0.016)
(T) Thickness Max.	1.35 (0.053)	1.80 (0.071)	2.80 (0.110)	2.20 (0.087)	2.80 (0.110)	3.40 (0.134)	3.40 (0.134)	3.40 (0.134)
(t) terminal min. max.	0.50 ± 0.20 (0.020 ± 0.008)	0.60 ± 0.20 (0.024 ± 0.008)	0.75 ± 0.35 (0.030 ± 0.014)	0.75 ± 0.35 (0.030 ± 0.014)	0.75 ± 0.35 (0.030 ± 0.014)	0.75 ± 0.35 (0.030 ± 0.014)	0.85 ± 0.35 (0.033 ± 0.014)	0.85 ± 0.35 (0.033 ± 0.014)

*Reflow Soldering Only

Performance of SMPS capacitors can be simulated by downloading SpiCalci software program - <http://www.avx.com/download/software/SpiCalci-AVX.zip>
Custom values, ratings and configurations are also available.

MLC Chip Capacitors

High Voltage MLC Chips FLEXITERM®



NP0 (C0G) Dielectric

Performance Characteristics

Capacitance Range	10 pF to 0.100 µF (+25°C, 1.0 ±0.2 Vrms, 1kHz)
Capacitance Tolerances	±5%, ±10%, ±20%
Dissipation Factor	0.1% max. (+25°C, 1.0 ±0.2 Vrms, 1kHz)
Operating Temperature Range	-55°C to +125°C
Temperature Characteristic	0 ±30 ppm/°C (0 VDC)
Voltage Ratings	600, 630, 1000, 1500, 2000, 2500, 3000, 4000 & 5000 VDC (+125°C)
Insulation Resistance (+25°C, at 500 VDC)	100K MΩ min. or 1000 MΩ - µF min., whichever is less
Insulation Resistance (+125°C, at 500 VDC)	10K MΩ min. or 100 MΩ - µF min., whichever is less
Dielectric Strength	Minimum 120% rated voltage for 5 seconds at 50 mA max. current

NP0 (C0G) CAPACITANCE RANGE PREFERRED SIZES ARE SHADED

Case Size Soldering	0805			1206					1210					1808				1812												
	Reflow/Wave			Reflow/Wave					Reflow Only					Reflow Only				Reflow Only												
(L) Length mm (in.)	2.10 ± 0.20 (0.083 ± 0.008)			3.30 ± 0.30 (0.130 ± 0.012)					3.30 ± 0.40 (0.130 ± 0.016)					4.60 ± 0.50 (0.181 ± 0.020)				4.60 ± 0.50 (0.181 ± 0.020)												
(W) Width mm (in.)	1.25 ± 0.20 (0.049 ± 0.008)			1.60 +0.30/-0.10 (0.063+0.012/-0.004)					2.50 ± 0.30 (0.098 ± 0.012)					2.00 ± 0.20 (0.079 ± 0.008)				3.20 ± 0.30 (0.126 ± 0.012)												
(T) Thickness mm (in.)	1.35 (0.053)			1.80 (0.071)					2.80 (0.110)					2.20 (0.087)				2.80 (0.110)												
(t) Terminal mm (in.)	0.50 ± 0.20 (0.020 ± 0.008)			0.60 ± 0.20 (0.024 ± 0.008)					0.75 ± 0.35 (0.030 ± 0.014)					0.75 ± 0.35 (0.030 ± 0.014)				0.75 ± 0.35 (0.030 ± 0.014)												
Voltage(V)		600	630	1000	600	630	1000	1500	2000	600	630	1000	1500	2000	600	630	1000	1500	2000	2500	3000	4000	600	630	1000	1500	2000	2500	3000	4000
Cap (pF)	1.5	1R5	A	A			X	X	X	X	X																			
	1.8	1R8	A	A			X	X	X	X	X																			
	2.2	2R2	A	A			X	X	X	X	X																			
	2.7	2R7	A	A			X	X	X	X	X								C	C	C	C	C							
	3.3	3R3	A	A			X	X	X	X	X								C	C	C	C	C							
	3.9	3R9	A	A			X	X	X	X	X								C	C	C	C	C							
	4.7	4R7	A	A			X	X	X	X	X								C	C	C	C	C							
	5.6	5R6	A	A			X	X	X	X	X								C	C	C	C	C							
	6.8	6R8	A	A			X	X	X	X	X								C	C	C	C	C							
	8.2	8R2	A	A			X	X	X	X	X								C	C	C	C	C							
	10	100	A	A	A		X	X	X	X	X	C	C	C	D	D	D	C	C	C	C	C	C	C	C	C	C	C	C	E
	12	120	A	A	A		X	X	X	X	X	C	C	C	D	D	D	C	C	C	C	C	C	C	C	C	C	C	C	E
	15	150	A	A	A		X	X	X	X	X	C	C	C	D	D	D	C	C	C	C	C	C	C	C	C	C	C	C	E
	18	180	A	A	A		X	X	X	X	X	C	C	D	D	D	D	C	C	C	C	C	C	C	C	C	C	C	C	E
	22	220	A	A	A		X	X	X	X	X	C	C	D	D	D	D	C	C	C	C	C	C	C	C	C	C	C	C	E
	27	270	A	A	A		X	X	X	X	X	C	C	D	D	D	D	C	C	C	C	C	C	C	C	C	C	C	C	E
	33	330	A	A	A		X	X	X	D	D	C	C	D	D	D	D	C	C	C	C	C	C	C	C	C	C	C	C	E
	39	390	A	A	A		X	X	X	D	D	C	C	D	D	D	D	C	C	C	C	C	C	C	C	C	C	C	C	E
	47	470	A	A	A		X	X	M	D	D	C	C	D	D	D	D	C	C	C	C	C	C	C	C	C	C	C	C	E
	56	560	A	A	A		X	X	M	C	C	C	C	D	C	C	C	C	C	C	C	C	C	C	C	C	C	C	C	F
	68	680	A	A	A		X	X	M	C	C	C	C	D	C	C	C	C	C	C	C	C	C	C	C	C	C	C	C	F
	82	820	X	X	X		X	X	C	C	C	C	C	D	C	C	C	C	C	C	C	C	C	C	C	C	C	C	C	F
	100	101	X	X	X		X	X	C	C	C	C	C	C	C	C	C	C	C	C	C	C	F	F						F
	120	121	C	C	C		X	X	C	E	E	C	C	C	C	C	C	C	C	C	C	F	F	F	F					G
	150	151	C	C	C		X	X	C	E	E	C	C	C	E	E	E	C	C	F	F	F	F	F					G	
	180	181	C	C	C		X	X	E	E	E	C	C	E	E	E	E	C	C	F	F	F	F	F					G	
	220	221	C	C			X	X	E	E	E	C	C	E	E	E	E	C	C	F	F	F	F	F					G	
	270	271	C	C			C	C	E	E	E	C	C	E	E	E	E	C	C	F	F	F	F	F					G	
	330	331	C	C			C	C	E	E	E	C	C	E	E	E	E	C	C	F	F	F	F	F					G	
	390	391	C	C			C	C	E	E	E	C	C	E	E	E	E	C	C	F	F	F	F	F					G	
	470	471	C	C			C	C	E	E	E	C	C	E	E	E	E	C	C	F	F	F	F	F					G	
	560	561	C	C			C	C	E	E	E	C	C	E	E	E	E	C	C	F	F	F	F	F					G	
	680	681	C	C			C	C	E	E	E	C	C	E	F	F	F	C	C	F	F	F	F	F					G	
	750	751	C	C			E	E	E	E	E	C	C	E	F	G	G	C	C	F	F	F	F	F					G	
	820	821	C	C			E	E	E	E	E	C	C	E	G	G		C	C	F	E	E	E	E					G	
	1000	102					E	E	E	E	E	C	C	E				C	C	F	E	E	E	E					G	
	1200	122					E	E	E	E	E	C	C	E				E	E	F	E	E	E						G	
	1500	152					E	E	E	E	E	C	C	G				E	E	F									G	
	1800	182					E	E	E	E	E	C	C	G				E	E	F									G	
	2200	222					E	E	E	E	E	E	E					E	E										G	
	2700	272					E	E	E	E	E	E	E					E	E										G	
	3300	332					E	E	E	E	E	E	E					E	E										G	
	3900	392										E	E					E	E										G	
	4700	472										E	E					E	E										G	
	5600	562										E	E					E	E										G	
	6800	682																F	F										G	
	8200	822																											G	
Cap (µF)	0.010	103																												G
	0.012	123																												G
	0.015	153																												G
	0.018	183																												G
	0.022	223																												G
	0.033	333																												G
	0.047	473																												G
	0.056	563																												G
	0.068	683																												G
	0.100	104																												G



The Important Information/Disclaimer is incorporated in the catalog where these specifications came from or available online at www.avx.com/disclaimer/ by reference and should be reviewed in full before placing any order.

MLC Chip Capacitors

High Voltage MLC Chips FLEXITERM[®]



NP0 (C0G) CAPACITANCE RANGE PREFERRED SIZES ARE SHADED

Case Size		1825													2220													2225													
Soldering		Reflow Only													Reflow Only													Reflow Only													
(L) Length	mm (in)	4.60 ± 0.50 (0.181 ± 0.020)													5.70 ± 0.50 (0.224 ± 0.020)													5.72 ± 0.25 (0.225 ± 0.010)													
(W) Width	mm (in)	6.30 ± 0.40 (0.248 ± 0.016)													5.00 ± 0.40 (0.197 ± 0.016)													6.35 ± 0.25 (0.250 ± 0.010)													
(T) Thickness	mm (in)	3.40 (0.134)													3.40 (0.134)													2.54 (0.100)													
(t) Terminal	mm (in)	0.75 ± 0.35 (0.030 ± 0.014)													0.85 ± 0.35 (0.033 ± 0.014)													0.85 ± 0.35													
Voltage(V)		600	630	1000	1500	2000	2500	3000	4000	600	630	1000	1500	2000	2500	3000	4000	5000	600	630	1000	1500	2000	2500	3000	4000	5000														
Cap (pF)	1.5	1R5																																							
	1.8	1R8																																							
	2.2	2R2																																							
	2.7	2R7																																							
	3.3	3R3																																							
	3.9	3R9																																							
	4.7	4R7																																							
	5.6	5R6																																							
	6.8	6R8																																							
	8.2	8R2																																							
	10	100	E	E	E	E	E	E	E	E	E	E	E	E	E	E	E	E	E	E	E	E	E	E	E	E	E	E	E	E	E	E	E	E	E	E	F	F			
	12	120	E	E	E	E	E	E	E	E	E	E	E	E	E	E	E	E	E	E	E	E	E	E	E	E	E	E	E	E	E	E	E	E	E	E	E	F	F		
	15	150	E	E	E	E	E	E	E	E	E	E	E	E	E	E	E	E	E	E	E	E	E	E	E	E	E	E	E	E	E	E	E	E	E	E	E	F	F		
	18	180	E	E	E	E	E	E	E	E	E	E	E	E	E	E	E	E	E	E	E	E	E	E	E	E	E	E	E	E	E	E	E	E	E	E	F	F			
	22	220	E	E	E	E	E	E	E	E	E	E	E	E	E	E	E	E	E	E	E	E	E	E	E	E	E	E	E	E	E	E	E	E	E	E	E	F	F		
	27	270	E	E	E	E	E	E	E	E	E	E	E	E	E	E	E	E	E	E	E	E	E	E	E	E	E	E	E	E	E	E	E	E	E	E	E	F	F		
	33	330	E	E	E	E	E	E	E	E	E	E	E	E	E	E	E	E	E	E	E	E	E	E	E	E	E	E	E	E	E	E	E	E	E	E	F	F			
	39	390	E	E	E	E	E	E	E	E	E	E	E	E	E	E	E	E	E	E	E	E	E	E	E	E	E	E	E	E	E	E	E	E	E	E	F	F			
	47	470	E	E	E	E	E	E	E	E	F	E	E	E	E	E	E	E	E	E	E	E	E	E	E	E	E	E	E	E	E	E	E	E	E	E	F	G			
	56	560	E	E	E	E	E	E	E	F	E	E	E	E	E	E	E	E	E	E	E	E	E	E	E	E	E	E	E	E	E	E	E	E	E	E	F	G			
	68	680	E	E	E	E	E	E	E	F	E	E	E	E	E	E	E	E	E	E	E	E	E	E	E	E	E	E	E	E	E	E	E	E	E	E	F	G			
	82	820	E	E	E	E	E	E	E	F	E	E	E	E	E	E	E	E	E	E	E	E	E	E	E	E	E	E	E	E	E	E	E	E	E	E	F	G			
	100	101	E	E	E	E	E	E	E	F	E	E	E	E	E	E	E	E	E	E	E	E	E	E	E	E	E	E	E	E	E	E	E	E	E	E	G	G			
	120	121	E	E	E	E	E	E	E	F	E	E	E	E	E	E	E	E	E	E	E	E	E	E	E	E	E	E	E	E	E	E	E	E	E	E	G	G			
	150	151	E	E	E	E	E	E	E	F	E	E	E	E	E	E	E	E	E	E	E	E	E	E	E	E	E	E	E	E	E	E	E	E	E	E	E	G	G		
	180	181	E	E	E	E	E	E	E	F	E	E	E	E	E	E	E	F	F	E	E	E	E	E	E	E	E	E	E	E	E	E	E	E	E	E	G	G			
	220	221	E	E	E	E	E	E	E	F	E	E	E	E	E	E	E	E	F	F	E	E	E	E	E	E	E	E	E	E	E	E	E	E	E	E	G	G			
	270	271	E	E	E	E	E	E	E	F	E	E	E	E	E	E	E			E	E	E	E	E	E	E	E	E	E	E	E	E	E	E	E	E	G	G			
	330	331	E	E	E	E	E	E	E	F	E	E	E	E	E	E	E			E	E	E	E	E	E	E	E	E	E	E	E	E	E	E	E	E	E	G			
	390	391	E	E	E	E	E	E	E		E	E	E	E	E	E	E			E	E	E	E	E	E	E	E	E	E	E	E	E	E	E	E	E	E	E			
	470	471	E	E	E	E	E	E	E		E	E	E	E	E	E	E			E	E	E	E	E	E	E	E	E	E	E	E	E	E	E	E	E	E	E	G		
	560	561	E	E	E	E	E	E	E		E	E	E	E	E	E	E			E	E	E	E	E	E	E	E	E	E	E	E	E	E	E	E	E	E	E	G		
	680	681	E	E	E	E	E	F	F		E	E	E	E	E	F	F			E	E	E	E	E	E	E	E	E	E	E	E	E	E	E	E	E	E	E			
	750	751	E	E	E	E	E	F	F		E	E	E	E	E	F	F			E	E	E	E	E	E	E	E	E	E	E	E	E	E	E	E	E	E	E			
	820	821	E	E	E	E	E	F	F		E	E	E	E	E	F	F			E	E	E	E	E	E	E	E	E	E	E	E	E	E	E	E	F	E				
	1000	102	E	E	E	E	E	F	F		E	E	E	E	E	F	F			E	E	E	E	E	E	E	E	E	E	E	E	E	E	E	E	E	E	E			
	1200	122	E	E	E	E	E	G	G		E	E	E	E	E	G	G			E	E	E	E	E	E	E	E	E	E	E	E	E	E	E	F	F					
	1500	152	E	E	E	F	F	G	G		E	E	E	F	F	G	G			E	E	E	E	E	E	E	E	E	E	E	E	E	E	F	F						
	1800	182	E	E	E	F	F	G	G		E	E	E	F	F	G	G			E	E	E	E	E	E	E	E	E	E	E	E	E	E	E	E	G	G				
	2200	222	E	E	E	G	G				E	E	E	G	G					E	E	E	E	E	E	E	E	E	E	E	E	E	E	E	E	E	E	E			
	2700	272	E	E	E	G	G				E	E	E	G	G					E	E	E	E	E	E	E	E	E	E	E	E	E	E	E	E	E	F	F			
	3300	332	E	E	E	G	G				E	E	E	G	G					E	E	E	E	E	E	E	E	E	E	E	E	E	E	F	F						
	3900	392	E	E	E	G	G				E	E	E	G	G					E	E	E	E	E	E	E	E	E	E	E	E	E	E	E	E	G	G				
	4700	472	E	E	E	G	G				E	E	E	G	G					F	F	F	F	G	G																
	5600	562	F	F	F	G	G				F	F	F	G	G					F	F	F	F	G	G																
	6800	682	F	F	F						F	F	F							F	F	F	F																		
	8200	822	G	G	G						G	G	G							G	G	G																			
	Cap (µF)	0.010	103																																						
		0.012	123																																						
		0.015	153																																						
		0.018	183																																						
		0.022	223																																						
		0.033	333																																						
		0.047	473																																						
		0.056	563																																						
		0.068	683																																						
		0.100	104																																						
Voltage(V)		600	630	1000	1500	2000	2500	3000	4000	600	630	1000	1500	2000	2500	3000	4000	5000	600	630	1000	1500</																			

MLC Chip Capacitors

High Voltage MLC Chips FLEXITERM®



X7R Dielectric

Performance Characteristics

Capacitance Range	10 pF to 0.82 µF (25°C, 1.0 ±0.2 Vrms at 1kHz)
Capacitance Tolerances	±10%; ±20%; +80%, -20%
Dissipation Factor	2.5% max. (+25°C, 1.0 ±0.2 Vrms, 1kHz)
Operating Temperature Range	-55°C to +125°C
Temperature Characteristic	±15% (0 VDC)
Voltage Ratings	600, 630, 1000, 1500, 2000, 2500, 3000, 4000 & 5000 VDC (+125°C)
Insulation Resistance (+25°C, at 500 VDC)	100K MΩ min. or 1000 MΩ - µF min., whichever is less
Insulation Resistance (+125°C, at 500 VDC)	10K MΩ min. or 100 MΩ - µF min., whichever is less
Dielectric Strength	Minimum 120% rated voltage for 5 seconds at 50 mA max. current

X7R CAPACITANCE RANGE

PREFERRED SIZES ARE SHADED

Case Size Soldering	0805					1206					1210					1808					1812								
	Reflow/Wave					Reflow/Wave					Reflow Only					Reflow Only					Reflow Only								
(L) Length mm (in.)	2.10 ± 0.20 (0.083 ± 0.008)					3.30 ± 0.30 (0.130 ± 0.012)					3.30 ± 0.40 (0.130 ± 0.016)					4.60 ± 0.50 (0.181 ± 0.020)					4.60 ± 0.50 (0.181 ± 0.020)								
(W) Width mm (in.)	1.25 ± 0.20 (0.049 ± 0.008)					1.60 ± 0.30/-0.10 (0.063 ± 0.012/-0.004)					2.50 ± 0.30 (0.098 ± 0.012)					2.00 ± 0.20 (0.079 ± 0.008)					3.20 ± 0.30 (0.126 ± 0.012)								
(T) Thickness mm (in.)	1.35 (0.053)					1.80 (0.071)					2.80 (0.110)					2.20 (0.087)					2.80 (0.110)								
(t) Terminal min max	0.50 ± 0.20 (0.020 ± 0.008)					0.60 ± 0.20 (0.024 ± 0.008)					0.75 ± 0.35 (0.030 ± 0.014)					0.75 ± 0.35 (0.030 ± 0.014)					0.75 ± 0.35 (0.030 ± 0.014)								
Voltage(V)	600	630	1000	600	630	1000	1500	2000	600	630	1000	1500	2000	600	630	1000	1500	2000	2500	3000	4000	600	630	1000	1500	2000	2500	3000	4000
Cap (pF)	100	101	X	X	C	C	C	E	E	E	E	E	E	E	E	E	E	E	E	F	E	E	E	E	E	E	E	E	
	120	121	X	X	C	C	C	E	E	E	E	E	E	E	E	E	E	E	E	F	E	E	E	E	E	E	E	E	
	150	151	X	X	C	C	C	E	E	E	E	E	E	E	E	E	E	E	E	F	E	E	E	E	E	E	E	E	
	180	181	X	X	C	C	C	E	E	E	E	E	E	E	E	E	E	E	E	F	E	E	E	E	E	E	E	E	
	220	221	X	X	C	C	C	E	E	E	E	E	E	E	E	E	E	E	E	F	E	E	E	E	E	E	E	E	
	270	271	X	X	C	C	C	E	E	E	E	E	E	E	E	E	E	E	E	F	E	E	E	E	E	E	E	E	
	330	331	X	X	C	C	C	E	E	E	E	E	E	E	E	E	E	E	E	F	E	E	E	E	E	E	E	E	
	390	391	X	X	C	C	C	E	E	E	E	E	E	E	E	E	E	E	E	F	E	E	E	E	E	E	E	E	
	470	471	X	X	C	C	C	E	E	E	E	E	E	E	E	E	E	E	E	F	E	E	E	E	E	E	E	E	
	560	561	X	X	C	C	C	E	E	E	E	E	E	E	E	E	E	E	E	F	E	E	E	E	E	E	E	E	
	680	681	X	X	C	C	C	E	E	E	E	E	E	E	E	E	E	E	E	F	E	E	E	E	E	E	E	E	
	750	751	X	X	C	C	C	E	E	E	E	E	E	E	E	E	E	E	E	F	E	E	E	E	E	E	E	E	
	820	821	X	X	C	C	C	E	E	E	E	E	E	E	E	E	E	E	E	F	E	E	E	E	E	E	E	E	
	1000	102	X	X	C	C	C	E	E	E	E	E	E	E	E	E	E	E	E	F	E	E	E	E	E	E	E	E	
	1200	122	X	X	C	C	C	E	E	E	E	E	E	E	E	E	E	E	E	F	E	E	E	E	E	E	E	E	
	1500	152	X	X	C	C	C	E	E	E	E	E	E	E	E	E	E	E	E	F	E	E	E	E	E	E	E	E	
	1800	182	X	X	C	C	C	E	E	E	E	E	E	E	E	E	E	E	E	F	E	E	E	E	E	E	E	E	
	2200	222	X	X	C	C	C	E	E	E	E	E	E	E	E	E	E	E	E	F	E	E	E	E	E	E	E	E	
	2700	272	X	X	C	C	C	E	E	E	E	E	E	E	E	E	E	E	E	F	E	E	E	E	E	E	E	E	
	3300	332	X	X	C	C	C	E	E	E	E	E	E	E	E	E	E	E	E	F	E	E	E	E	E	E	E	E	
	3900	392	X	X	C	C	C	E	E	E	E	E	E	E	E	E	E	E	E	F	E	E	E	E	E	E	E	E	
	4700	472	X	X	C	C	C	E	E	E	E	E	E	E	E	E	E	E	E	F	E	E	E	E	E	E	E	E	
	5600	562	X	X	C	C	C	E	E	E	E	E	E	E	E	E	E	E	E	F	E	E	E	E	E	E	E	E	
	6800	682	X	X	C	C	C	E	E	E	E	E	E	E	E	E	E	E	E	F	E	E	E	E	E	E	E	E	
	8200	822	X	X	C	C	C	E	E	E	E	E	E	E	E	E	E	E	E	F	E	E	E	E	E	E	E	E	
Cap (µF)	0.010	103	C	C	C	C	E	E	E	E	E	E	E	E	E	E	E	E	E	F	E	E	E	E	E	E	E	E	
	0.015	153	C	C	C	C	E	E	E	E	E	E	E	E	E	E	E	E	E	F	E	E	E	E	E	E	E	E	
	0.018	183	C	C	C	C	E	E	E	E	E	E	E	E	E	E	E	E	E	F	E	E	E	E	E	E	E	E	
	0.022	223	C	C	C	C	E	E	E	E	E	E	E	E	E	E	E	E	E	F	E	E	E	E	E	E	E	E	
	0.027	273	C	C	C	C	E	E	E	E	E	E	E	E	E	E	E	E	E	F	E	E	E	E	E	E	E	E	
	0.033	333	C	C	C	C	E	E	E	E	E	E	E	E	E	E	E	E	E	F	E	E	E	E	E	E	E	E	
	0.039	393	C	C	C	C	E	E	E	E	E	E	E	E	E	E	E	E	E	F	E	E	E	E	E	E	E	E	
	0.047	473	C	C	C	C	E	E	E	E	E	E	E	E	E	E	E	E	E	F	E	E	E	E	E	E	E	E	
	0.056	563	C	C	C	C	E	E	E	E	E	E	E	E	E	E	E	E	E	F	E	E	E	E	E	E	E	E	
	0.068	683	C	C	C	C	E	E	E	E	E	E	E	E	E	E	E	E	E	F	E	E	E	E	E	E	E	E	
	0.082	823	C	C	C	C	E	E	E	E	E	E	E	E	E	E	E	E	E	F	E	E	E	E	E	E	E	E	
	0.100	104	C	C	C	C	E	E	E	E	E	E	E	E	E	E	E	E	E	F	E	E	E	E	E	E	E	E	
	0.150	154	C	C	C	C	E	E	E	E	E	E	E	E	E	E	E	E	E	F	E	E	E	E	E	E	E	E	
	0.220	224	C	C	C	C	E	E	E	E	E	E	E	E	E	E	E	E	E	F	E	E	E	E	E	E	E	E	
	0.270	274	C	C	C	C	E	E	E	E	E	E	E	E	E	E	E	E	E	F	E	E	E	E	E	E	E	E	
	0.330	334	C	C	C	C	E	E	E	E	E	E	E	E	E	E	E	E	E	F	E	E	E	E	E	E	E	E	
	0.390	394	C	C	C	C	E	E	E	E	E	E	E	E	E	E	E	E	E	F	E	E	E	E	E	E	E	E	
	0.470	474	C	C	C	C	E	E	E	E	E	E	E	E	E	E	E	E	E	F	E	E	E	E	E	E	E	E	
	0.560	564	C	C	C	C	E	E	E	E	E	E	E	E	E	E	E	E	E	F	E	E	E	E	E	E	E	E	
	0.680	684	C	C	C	C	E	E	E	E	E	E	E	E	E	E	E	E	E	F	E	E	E	E	E	E	E	E	
	0.820	824	C	C	C	C	E	E	E	E	E	E	E	E	E	E	E	E	E	F	E	E	E	E	E	E	E	E	
	1.000	105	C	C	C	C	E	E	E	E	E	E	E	E	E	E	E	E	E	F	E	E	E	E	E	E	E	E	
Voltage(V) CaseSize	600	630	1000	600	630	1000	1500	2000	600	630	1000	1500	2000	600	630	1000	1500	2000	2500	3000	4000	600	630	1000	1500	2000	2500	3000	4000
	0805					1206					1210					1808					1812								

MLC Chip Capacitors

High Voltage MLC Chips FLEXITERM®



X7R CAPACITANCE RANGE PREFERRED SIZES ARE SHADED

Case Size	1825								2220								2225									
Soldering	Reflow Only								Reflow Only								Reflow Only									
(L) Length mm (in.)	4.60 ± 0.50 (0.181 ± 0.020)								5.70 ± 0.50 (0.224 ± 0.020)								5.72 ± 0.25 (0.225 ± 0.010)									
(W) Width mm (in.)	6.30 ± 0.40 (0.248 ± 0.016)								5.00 ± 0.40 (0.197 ± 0.016)								6.35 ± 0.25 (0.250 ± 0.010)									
(T) Thickness mm (in.)	3.40 (0.134)								3.40 (0.134)								2.54 (0.100)									
(t) Terminal min max	0.75 ± 0.35 (0.030 ± 0.014)								0.85 ± 0.35 (0.033 ± 0.014)								0.85 ± 0.35									
Voltage(V)	600	630	1000	1500	2000	2500	3000	4000	600	630	1000	1500	2000	2500	3000	4000	5000	600	630	1000	1500	2000	2500	3000	4000	5000
Cap (pF) 100 101																										
120 121																										
150 151																										
180 181																										
220 221																										
270 271																										
330 331																										
390 391																										
470 471																										
560 561																										
680 681																										
750 751																										
820 821																										
1000 102	F	F	F	F	F	F	F		F	F	F	F	F	F	F	G		F	F	F	F	F	F	F	F	
1200 122	F	F	F	F	F	F	F		F	F	F	F	F	F	F	G		F	F	F	F	F	F	F	F	
1500 152	F	F	F	F	F	F	F		F	F	F	F	F	F	F	G		F	F	F	F	F	F	F	F	
1800 182	F	F	F	F	F	F	F		F	F	F	F	F	F	F	G		F	F	F	F	F	F	F	F	
2200 222	F	F	F	F	F	F	F		F	F	F	F	F	F	F	G		F	F	F	F	F	F	F	F	
2700 272	F	F	F	F	F	F	F		F	F	F	F	F	F	F	G		F	F	F	F	F	F	F	F	
3300 332	F	F	F	F	F	F	F		F	F	F	F	F	F	F	G		F	F	F	F	F	F	F	F	
3900 392	F	F	F	F	F	F	F		F	F	F	F	F	F	F	G		F	F	F	F	F	F	F	F	
4700 472	F	F	F	F	F	F	F		F	F	F	F	F	F	F	G		F	F	F	F	F	F	F	F	
5600 562	F	F	F	F	F	F	F		F	F	F	F	F	F	F	G		F	F	F	F	F	F	F	F	
6800 682	F	F	F	G	G	G	G		F	F	F	F	F	F	G	G		F	F	F	F	F	F	G	G	
8200 822	F	F	F	G	G	G	G		F	F	F	G	G	G	G	G		F	F	F	F	F	G	G	G	
Cap (µF) 0.010 103	F	F	F	G	G	G	G		F	F	F	G	G	G	G		F	F	F	F	F	G	G	G	G	
0.015 153	F	F	F	G	G	G			F	F	F	G	G	G				F	F	F	G	G	G	G	G	
0.018 183	F	F	F	G	G				F	F	F	G	G	G				F	F	F	G	G	G	G		
0.022 223	F	F	F	G	G				F	F	F	G	G					F	F	F	G	G	G	G		
0.027 273	F	F	F	G					F	F	F	G	G					F	F	F	G	G				
0.033 333	F	F	F	G					F	F	F	G						F	F	F	G					
0.039 393	F	F	F	G					F	F	F	G						F	F	F	G					
0.047 473	F	F	F	P					F	F	F	G						F	F	F	G					
0.056 563	F	F	F	G					F	F	F	G						F	F	F	G					
0.068 683	F	F	G						F	F	G							F	F	F	G					
0.082 823	F	F	G						F	F	G							F	F	G						
0.100 104	F	F	G						F	F	G							F	F	G						
0.150 154	F	F							F	F	G							F	F	G						
0.220 224	F	F							F	F	G							F	F							
0.270 274	F	F							F	F								F	F							
0.330 334	F	F							F	F								F	F							
0.390 394	F	F							F	F								F	F							
0.470 474	F	F							F	F								F	F							
0.560 564	G	G							G	G								F	F							
0.680 684									G	G								G	G							
0.820 824																		G	G							
1.000 105																		G	G							
Voltage(V)	600	630	1000	1500	2000	2500	3000	4000	600	630	1000	1500	2000	2500	3000	4000	5000	600	630	1000	1500	2000	2500	3000	4000	5000
CaseSize	1825								2220								2225									

Letter	A	C	E	F	G	P	X
Max. Thickness	0.813 (0.032)	1.448 (0.057)	1.8034 (0.071)	2.2098 (0.087)	2.794 (0.110)	3.048 (0.120)	0.940 (0.037)

NOTE: Contact factory for non-specified capacitance values



The Important Information/Disclaimer is incorporated in the catalog where these specifications came from or available online at www.avx.com/disclaimer/ by reference and should be reviewed in full before placing any order.

MLC Chip Capacitors

High Voltage MLC Leaded Chips

For 600V to 5000V Applications



HOW TO ORDER

1825	A	A	271	K	A	V	00N
AVX Style 1825 2225 3640	Voltage 600V/630V = C 1000V = A 1500V = S 2000V = G 2500V = W 3000V = H 4000V = J 5000V = K	Temperature Coefficient C0G = A X7R = C	Capacitance Code (2 significant digits + no. of zeros) Examples: 10 pF = 100 100 pF = 101 1,000 pF = 102 22,000 pF = 223 220,000 pF = 224	Capacitance Tolerance C0G: J = ±5% K = ±10% M = ±20% X7R: K = ±10% M = ±20% Z = +80%, -20%	Test Level A = Standard	Finish V = Uncoated W = Epoxy Coated	Lead Style 00N = Straight Lead 00J = Leads Formed In 00L = Leads Formed Out

Notes: Capacitors with X7R dielectrics are not intended for applications across AC supply mains or AC line filtering with polarity reversal. Contact plant for recommendations. Capacitors may require protective surface coating to prevent external arcing.

Not RoHS Compliant

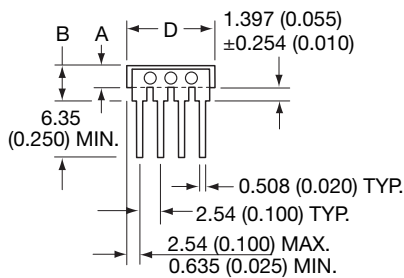

"N" STYLE LEADS

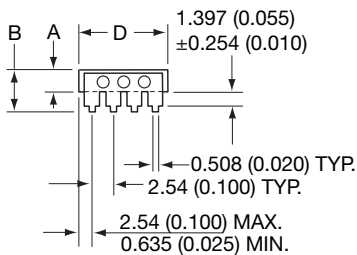
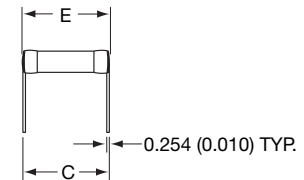

"J" STYLE LEADS

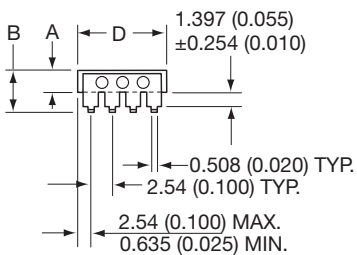
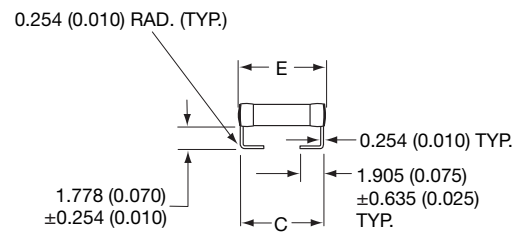

"L" STYLE LEADS

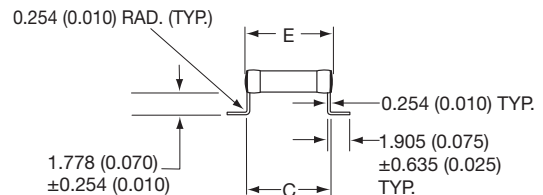

DIMENSIONS

millimeters (inches)

Style	A (max.)	B (max.)	C ±.635 (±0.025)	D ±.635 (±0.025)	E (max.)	No. of Leads per side
1825			5.08 (0.200)	6.35 (0.250)	6.86 (0.270)	3
2225	2.54 (0.100)	For "N" Style Leads, "B" Dimension = 4.19 (0.165) For "J" & "L" Leads, "B" Dimension = 4.58 (0.180)	6.35 (0.250)	6.35 (0.250)	7.62 (0.300)	3
3640			10.2 (0.400)	10.2 (0.400)	11.2 (0.440)	4

Note: For W (Epoxy Coated) part add 0.127 (0.005) to max. and nominal dimensions A, B, D, & E

Performance of SMPS capacitors can be simulated by downloading SpiCalci software program - <http://www.avx.com/download/software/SpiCalci-AVX.zip>
 Custom values, ratings and configurations are also available.



MLC Chip Capacitors

High Voltage MLC Leaded Chips

For 600V to 5000V Applications



COG Dielectric

Performance Characteristics

Capacitance Range	10 pF to 0.047 μ F (25°C, 1.0 \pm 0.2 Vrms at 1kHz, for \leq 1000 pF use 1 MHz)
Capacitance Tolerances	\pm 5%, \pm 10%, \pm 20%
Dissipation Factor	0.15% max. (+25°C, 1.0 \pm 0.2 Vrms, 1kHz, for \leq 1000 pF use 1 MHz)
Operating Temperature Range	-55°C to +125°C
Temperature Characteristic	0 \pm 30 ppm/°C (0 VDC)
Voltage Ratings	600, 630, 1000, 1500, 2000, 2500, 3000, 4000 & 5000 VDC (+125°C)
Insulation Resistance (+25°C, at 500 VDC)	100K M Ω min. or 1000 M Ω - μ F min., whichever is less
Insulation Resistance (+125°C, at 500 VDC)	10K M Ω min. or 100 M Ω - μ F min., whichever is less
Dielectric Strength	Minimum 120% rated voltage for 5 seconds at 50 mA max. current

HIGH VOLTAGE COG CAPACITANCE VALUES

VOLTAGE		1825	2225	3640
600/630	min.	1000 pF	1000 pF	1000 pF
	max.	0.012 μ F	0.018 μ F	0.047 μ F
1000	min.	100 pF	1000 pF	1000 pF
	max.	8200 pF	0.010 μ F	0.022 μ F
1500	min.	100 pF	100 pF	100 pF
	max.	4700 pF	5600 pF	0.010 μ F
2000	min.	100 pF	100 pF	100 pF
	max.	1800 pF	2700 pF	6800 pF
2500	min.	10 pF	100 pF	100 pF
	max.	1200 pF	1800 pF	3900 pF
3000	min.	10 pF	10 pF	100 pF
	max.	8200 pF	1200 pF	2700 pF
4000	min.	10 pF	10 pF	100 pF
	max.	330 pF	560 pF	1200 pF
5000	min.	—	10 pF	10 pF
	max.	—	270 pF	820 pF

X7R Dielectric

Performance Characteristics

Capacitance Range	100 pF to 0.56 μ F (25°C, 1.0 \pm 0.2 Vrms at 1kHz)
Capacitance Tolerances	\pm 10%; \pm 20%; +80%, -20%
Dissipation Factor	2.5% max. (+25°C, 1.0 \pm 0.2 Vrms, 1kHz)
Operating Temperature Range	-55°C to +125°C
Temperature Characteristic	\pm 15% (0 VDC)
Voltage Ratings	600, 630, 1000, 1500, 2000, 2500, 3000, 4000 & 5000 VDC (+125°C)
Insulation Resistance (+25°C, at 500 VDC)	100K M Ω min. or 1000 M Ω - μ F min., whichever is less
Insulation Resistance (+125°C, at 500 VDC)	10K M Ω min. or 100 M Ω - μ F min., whichever is less
Dielectric Strength	Minimum 120% rated voltage for 5 seconds at 50 mA max. current

HIGH VOLTAGE X7R MAXIMUM CAPACITANCE VALUES

VOLTAGE		1825	2225	3640
600/630	min.	0.010 μ F	0.010 μ F	0.010 μ F
	max.	0.270 μ F	0.330 μ F	0.560 μ F
1000	min.	1000 pF	1000 pF	0.010 μ F
	max.	0.100 μ F	0.150 μ F	0.220 μ F
1500	min.	1000 pF	1000 pF	1000 pF
	max.	0.056 μ F	0.068 μ F	0.100 μ F
2000	min.	100 pF	1000 pF	1000 pF
	max.	0.022 μ F	0.033 μ F	0.027 μ F
2500	min.	100 pF	100 pF	1000 pF
	max.	0.015 μ F	0.022 μ F	0.022 μ F
3000	min.	100 pF	100 pF	1000 pF
	max.	0.010 μ F	0.015 μ F	0.018 μ F
4000	min.	—	—	100 pF
	max.	—	—	6800 pF
5000	min.	—	—	100 pF
	max.	—	—	3300 pF

MLC Chip Capacitors

Tip & Ring Chips



AVX "Tip & Ring" or "ring detector" Multilayer Ceramic Chip Capacitors are designed as a standard telecom filter to block -48 Volts DC telephone line voltage and pass subscriber's AC signal pulse (16 to 25Hz, 70 to 90Vrms). The typical ringing signal is seen on figure on page 132. The ringer capacitors replace large leaded film capacitors and are ideal for telecom/modem applications. Using AVX "Tip & Ring" capacitors not only saves valuable real estate on the board and reduces the weight of overall product, but also features standard surface mounting capabilities, so critical to new and compact designs.

The AVX "Tip & Ring" capacitors are offered in standard EIA sizes and standard values. They offer excellent high frequency performance, low ESR and improved temperature performance over film capacitors.

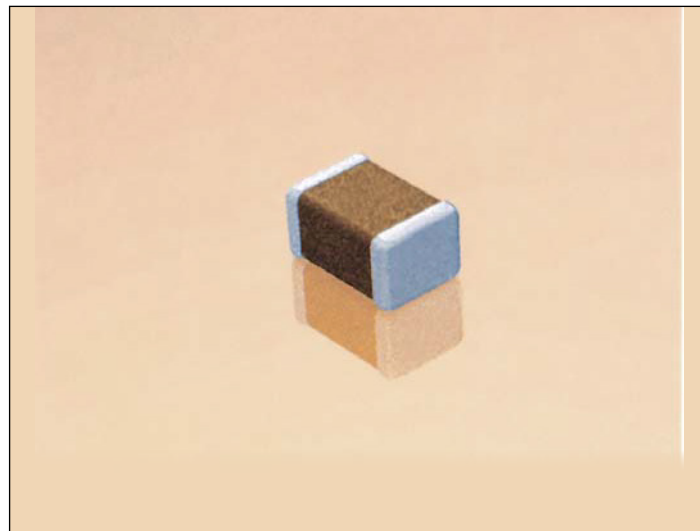

HOW TO ORDER

1812

AVX Style
0805
1206
1210
1808
1812
1825
2220
2225

P

Voltage
250 VDC
Telco
Rating

C

Temperature Coefficient
X7R

104

Capacitance Code
(2 significant digits + no. of zeros)
Examples:
1,000 pF = 102
22,000 pF = 223
220,000 pF = 224
1 μF = 105

K

Capacitance Tolerance
K = ±10%
M = ±20%

A

Test Level
A = Standard

T

Termination
T = P l a t e d 1 or 2 = 7" Reel
Ni and Sn³ or 4 = 13" Reel
(RoHS Compliant)
9 = Bulk
Z = F L E X I T E R M[®]
100% Tin
(RoHS Compliant)

1

Packaging
d1 or 2 = 7" Reel
Sn³ or 4 = 13" Reel
9 = Bulk

A

Special Code
A = Standard

Contact factory for availability of Termination and Tolerance options for Specific Part Numbers.

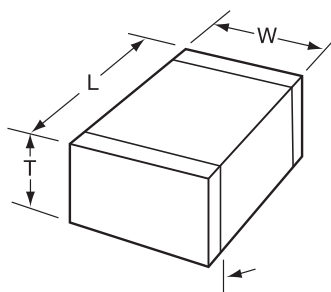

DIMENSIONS

millimeters (inches)

Style	0805	1206	1210*	1808*	1812*	1825*	2220*	2225*
(L) Length	2.01 ± 0.20 (0.079 ± 0.008)	3.20 ± 0.20 (0.126 ± 0.008)	3.2 ± 0.20 (0.126 ± 0.008)	4.57 ± 0.25 (0.180 ± 0.010)	4.50 ± 0.30 (0.177 ± 0.012)	4.50 ± 0.30 (0.177 ± 0.012)	5.60 ± 0.30 (0.220 ± 0.012)	5.60 ± 0.25 (0.220 ± 0.010)
(W) Width	1.25 ± 0.20 (0.049 ± 0.008)	1.60 ± 0.20 (0.063 ± 0.008)	2.50 ± 0.20 (0.098 ± 0.008)	2.03 ± 0.25 (0.080 ± 0.010)	3.2 ± 0.20 (0.126 ± 0.008)	6.34 ± 0.30 (0.252 ± 0.012)	5.10 ± 0.40 (0.200 ± 0.016)	6.35 ± 0.25 (0.250 ± 0.010)
(T) Thickness	1.30 max. (0.051 max.)	1.50 max. (0.059 max.)	1.78 max. (0.070 max.)	1.78 max. (0.070 max.)	2.00 max. (0.080 max.)	2.00 max. (0.080 max.)	2.00 max. (0.080 max.)	2.00 max. (0.080 max.)
(t) terminal	0.50 ± 0.25 (0.020 ± 0.010)	0.50 ± 0.25 (0.020 ± 0.010)	0.50 ± 0.25 (0.020 ± 0.010)	0.63 ± 0.38 (0.025 ± 0.015)	0.63 ± 0.38 (0.025 ± 0.015)	0.63 ± 0.38 (0.025 ± 0.015)	0.63 ± 0.38 (0.025 ± 0.015)	0.63 ± 0.38 (0.025 ± 0.015)

*Reflow Soldering Only

MLC Chip Capacitors

Tip & Ring Chips

CAPACITANCE RANGE (MF)

Size	0805	1206	1210	1808	1812	1825	2220	2225
min.	0.0010	0.0010	0.0010	0.010	0.10	0.33	0.47	0.47
max.	0.027	0.082	0.22	0.27	0.47	1.0	1.0	1.2

“TIP & RING” GRAPH

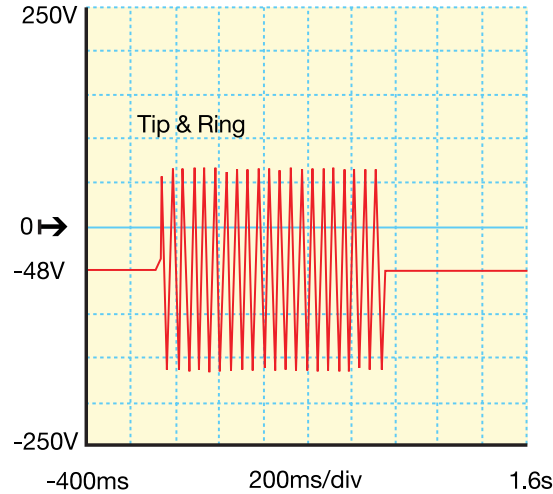

PERFORMANCE CHARACTERISTICS

Capacitance Range	1000 pF to 1.2 μ F (25°C, 1.0 \pm 0.2 Vrms at 1kHz)
Capacitance Tolerances	\pm 10%, \pm 20%
Dissipation Factor	2.5% max. (25°C, 1.0 \pm 0.2 Vrms at 1kHz)
Operating Temperature Range	-55°C to +125°C
Temperature Characteristic	X7R \pm 15% (0 VDC)
Voltage Rating	250 VDC Telco rating
Insulation Resistance	1000 megohm-microfarad min.
Dielectric Strength	Minimum 200% rated voltage for 5 seconds at 50 mA max. current

MLC Chip Capacitors

Tip & Ring Tin/Lead Termination "B"



AVX Corporation will support customers for commercial and military Multilayer Ceramic Capacitors with a termination consisting of 5% minimum lead. This termination is indicated by the use of a "B" in the 12th position of the AVX Catalog Part Number. This fulfills AVX's commitment to providing a full range of products to our customers. AVX has provided in the following pages, a full range of values that we are offering in this "B" termination.

AVX "Tip & Ring" or "ring detector" Multilayer Ceramic Chip Capacitors are designed as a standard telecom filter to block -48 Volts DC telephone line voltage and pass subscriber's AC signal pulse (16 to 25Hz, 70 to 90 VRMS). The typical ringing signal is seen on figure on page 134. The ringer capacitors replace large leaded film capacitors and are ideal for telecom/modem applications. Using AVX "Tip and Ring" capacitors not only saves valuable real estate on the board and reduces the weight of the overall product, but also features standard surface mounting capabilities, so critical to new and compact designs.

The AVX "Tip & Ring" capacitors are offered in standard EIA sizes and standard values. They offer excellent high frequency performance, low ESR and improved temperature performance over film capacitors.

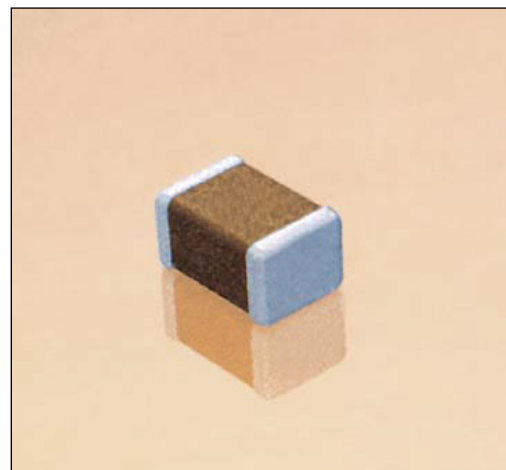

HOW TO ORDER

1812	P	C	104	K	A	B	1	A
AVX Style	Voltage	Temperature Coefficient	Capacitance Code	Capacitance Tolerance	Test Level	Termination	Packaging	Special Code
LD05 - 0805 LD06 - 1206 LD10 - 1210 LD08 - 1808 LD12 - 1812 LD13 - 1825 LD20 - 2220 LD14 - 2225	250 VDC Telco Rating	X7R	(2 significant digits + no. of zeros) Examples: 1,000 pF = 102 22,000 pF = 223 220,000 pF = 224 1 μF = 105	K = ±10% M = ±20%	A = Standard	B = 5% Min Pb X = FLEXITERM® 5% min. Pb	1 = 7" Reel 3 = 13" Reel 9 = Bulk	A = Standard

Contact factory for availability of Termination and Tolerance options for Specific Part Numbers.

[Not RoHS Compliant]

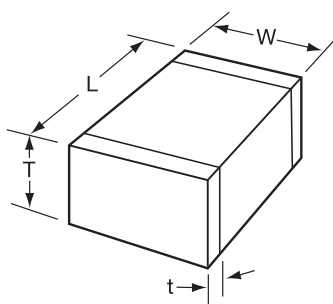

DIMENSIONS

millimeters (inches)

STYLE (SIZE)	LD05 (0805)	LD06 (1206)	LD10* (1210)	LD08* (1808)	LD12* (1812)	LD13* (1825)	LD20* (2220)	LD14* (2225)
(L) Length	2.01 ± 0.20 (0.079 ± 0.008)	3.20 ± 0.20 (0.126 ± 0.008)	3.2 ± 0.20 (0.126 ± 0.008)	4.57 ± 0.25 (0.180 ± 0.010)	4.50 ± 0.30 (0.177 ± 0.012)	4.50 ± 0.30 (0.177 ± 0.012)	5.60 ± 0.30 (0.220 ± 0.012)	5.60 ± 0.25 (0.220 ± 0.010)
(W) Width	1.25 ± 0.20 (0.049 ± 0.008)	1.60 ± 0.20 (0.063 ± 0.008)	2.50 ± 0.20 (0.098 ± 0.008)	2.03 ± 0.25 (0.080 ± 0.010)	3.2 ± 0.20 (0.126 ± 0.008)	6.34 ± 0.30 (0.252 ± 0.012)	5.10 ± 0.40 (0.200 ± 0.016)	6.35 ± 0.25 (0.250 ± 0.010)
(T) Thickness	1.30 max. (0.051 max.)	1.50 max. (0.059 max.)	1.78 max. (0.070 max.)	1.78 max. (0.070 max.)	2.00 max. (0.080 max.)	2.00 max. (0.080 max.)	2.00 max. (0.080 max.)	2.00 max. (0.080 max.)
(t) terminal	0.50 ± 0.25 (0.020 ± 0.010)	0.50 ± 0.25 (0.020 ± 0.010)	0.50 ± 0.25 (0.020 ± 0.010)	0.63 ± 0.38 (0.025 ± 0.015)	0.63 ± 0.38 (0.025 ± 0.015)	0.63 ± 0.38 (0.025 ± 0.015)	0.63 ± 0.38 (0.025 ± 0.015)	0.63 ± 0.38 (0.025 ± 0.015)

*Reflow Soldering Only

MLC Chip Capacitors

Tip & Ring Tin/Lead Termination “B”

CAPACITANCE RANGE (MF)

STYLE (SIZE)	LD05 (0805)	LD06 (1206)	LD10 (1210)	LD08 (1808)	LD12 (1812)	LD13 (1825)	LD20 (2220)	LD14 (2225)
min.	0.0010	0.0010	0.0010	0.010	0.10	0.33	0.47	0.47
max.	0.027	0.082	0.22	0.27	0.47	1.0	1.0	1.2

“TIP & RING” GRAPH

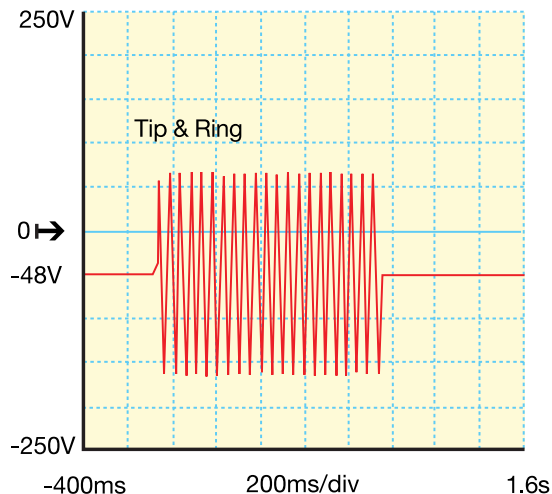

PERFORMANCE CHARACTERISTICS

Capacitance Range	1000 pF to 1.2 μ F (25°C, 1.0 \pm 0.2 Vrms at 1kHz)
Capacitance Tolerances	\pm 10%, \pm 20%
Dissipation Factor	2.5% max. (25°C, 1.0 \pm 0.2 Vrms at 1kHz)
Operating Temperature Range	-55°C to +125°C
Temperature Characteristic	X7R \pm 15% (0 VDC)
Voltage Rating	250 VDC Telco rating
Insulation Resistance	1000 megohm-microfarad min.
Dielectric Strength	Minimum 200% rated voltage for 5 seconds at 50 mA max. current

MLC Chip Capacitors

Packaging – Automatic Insertion Packaging



TAPE & REEL QUANTITIES

All tape and reel specifications are in compliance with RS481.

	4mm	8mm	12mm	
Paper or Embossed Carrier		0612, 0508, 0805, 1206, 1210		
Embossed Only	0101		1808	1812, 1825, 2220, 2225
Paper Only		0101, 0201, 0306, 0402, 0603		
Qty. per Reel/7" Reel	4,000	1,000, 2,000, 3,000 or 4,000, 10,000, 15,000, 20,000 Contact factory for exact quantity	3,000	500, 1,000 Contact factory for exact quantity
Qty. per Reel/13" Reel		5,000, 10,000, 50,000 Contact factory for exact quantity	10,000	4,000

REEL DIMENSIONS

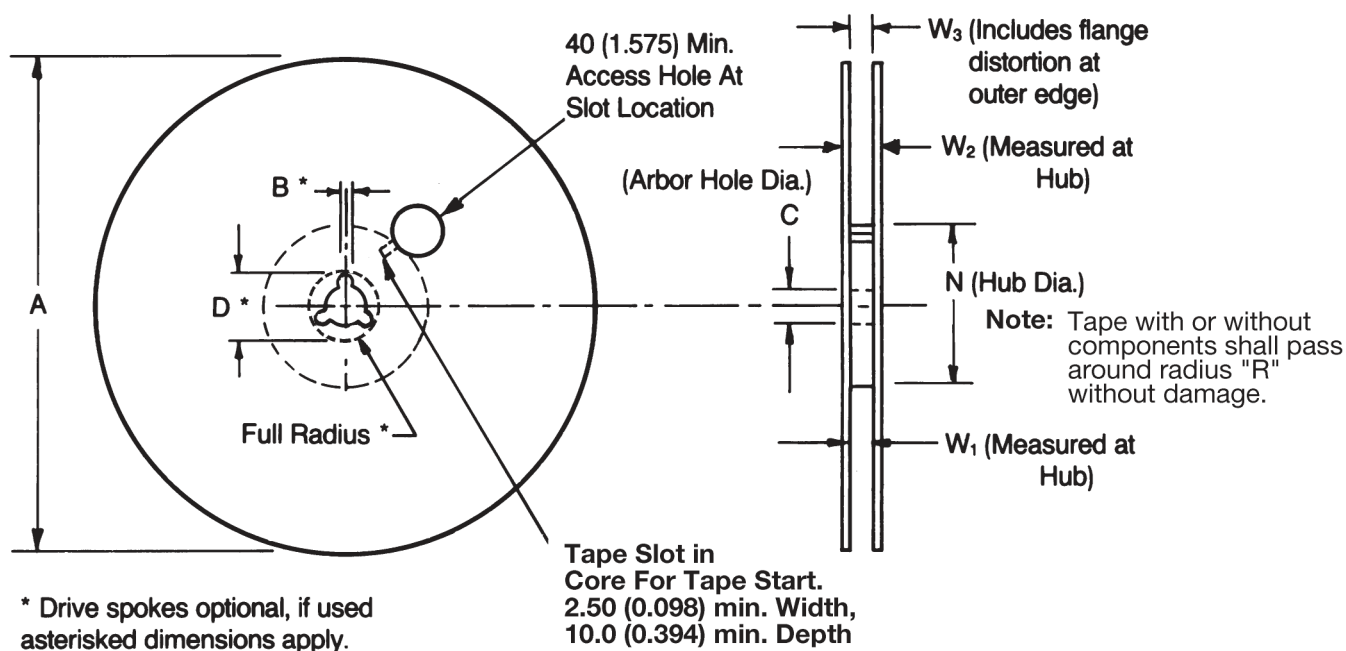

Tape Size(1)	A Max.	B* Min.	C	D* Min.	N Min.	W1	W2 Max.	W3
4mm	1.80 (7.087)	1.5 (0.059)	13.0±0.5 (0.522±0.020)	20.2 (0.795)	60.0 (2.362)	4.35±0.3 (0.171±0.011)	7.95 (0.312)	
8mm	330 (12.992)	1.5 (0.059)	13.0 ^{+0.50} _{-0.20} (0.512 ^{+0.020} _{-0.008})	20.2 (0.795)	50.0 (1.969)	8.40 ^{+1.5} _{-0.0} (0.331 ^{+0.059} _{-0.0})	14.4 (0.567)	7.90 Min. (0.311) 10.9 Max. (0.429)
12mm						12.4 ^{+2.0} _{-0.0} (0.488 ^{+0.079} _{-0.0})	18.4 (0.724)	11.9 Min. (0.469) 15.4 Max. (0.607)

Metric dimensions will govern.
English measurements rounded and for reference only.
(1) For tape sizes 16mm and 24mm (used with chip size 3640) consult EIA RS-481 latest revision.

MLC Chip Capacitors

Embossed Carrier Configuration – 4, 8 & 12mm Tape Only

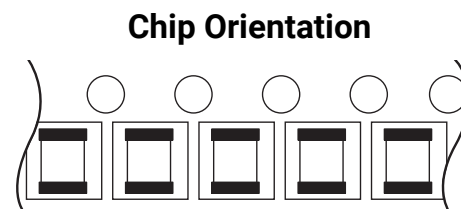
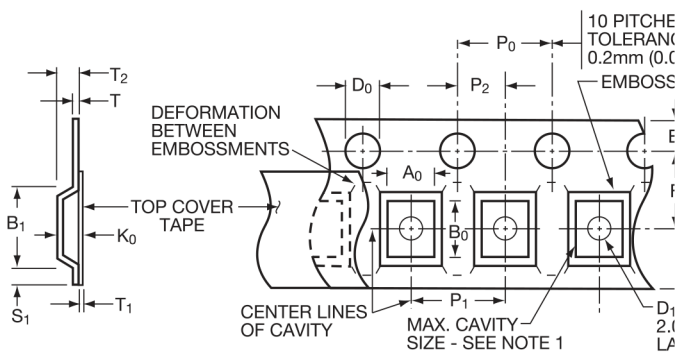

B₁ IS FOR TAPE READER REFERENCE ONLY INCLUDING DRAFT CONCENTRIC AROUND B₀

User Direction of Feed

4, 8 & 12mm Embossed Tape Metric Dimensions Will Govern

CONSTANT DIMENSIONS

Tape Size	D ₀	E ₁	P ₀	P ₂	S ₁ Min.	T Max.	T ₁ Max.
4mm	0.80±0.04 (0.031±0.001)	0.90±0.05 (0.035±0.001)	2.0±0.04 (0.078±0.001)	1.00±0.02 (0.039±0.0007)	1.075 (0.042)	0.26 (0.010)	0.06 (0.002)
8mm & 12mm	1.25 ± 0.20 (0.049 ± 0.008)	1.75 ± 0.10 (0.069 ± 0.004)	4.0 ± 0.10 (0.157 ± 0.004)	2.0 ± 0.05 (0.079 ± 0.002)	0.60 (0.024)	0.60 (0.024)	0.10 (0.004)

VARIABLE DIMENSIONS

Tape Size	B ₁ Max.	D ₁ Min.	E ₂ Min.	F	P ₁ See Note 5	R Min. See Note 2	T ₂	W Max.	A ₀ B ₀ K ₀
8mm	4.35 (0.171)	1.00 (0.039)	6.25 (0.246)	3.50 ± 0.05 (0.138 ± 0.002)	4.00 ± 0.10 (0.157 ± 0.004)	25.0 (0.984)	2.50 Max. (0.098)	8.30 (0.327)	See Note 1
12mm	8.20 (0.323)	1.50 (0.059)	10.25 (0.404)	5.50 ± 0.05 (0.217 ± 0.002)	4.00 ± 0.10 (0.157 ± 0.004)	30.0 (1.181)	6.50 Max. (0.256)	12.3 (0.484)	See Note 1
8mm 1/2 Pitch	4.35 (0.171)	1.00 (0.039)	6.25 (0.246)	3.50 ± 0.05 (0.138 ± 0.002)	2.00 ± 0.10 (0.079 ± 0.004)	25.0 (0.984)	2.50 Max. (0.098)	8.30 (0.327)	See Note 1
12mm Double Pitch	8.20 (0.323)	1.50 (0.059)	10.25 (0.404)	5.50 ± 0.05 (0.217 ± 0.002)	8.00 ± 0.10 (0.315 ± 0.004)	30.0 (1.181)	6.50 Max. (0.256)	12.3 (0.484)	See Note 1

NOTES:

- The cavity defined by A₀, B₀, and K₀ shall be configured to provide the following: Surround the component with sufficient clearance such that:
 - the component does not protrude beyond the sealing plane of the cover tape.
 - the component can be removed from the cavity in a vertical direction without mechanical restriction, after the cover tape has been removed.
 - rotation of the component is limited to 20° maximum (see Sketches D & E).
 - lateral movement of the component is restricted to 0.5mm maximum (see Sketch F).
- Tape with or without components shall pass around radius "R" without damage.
- Bar code labeling (if required) shall be on the side of the reel opposite the round sprocket holes. Refer to EIA-556.
- B₁ dimension is a reference dimension for tape feeder clearance only.
- If P₁ = 2.0mm, the tape may not properly index in all tape feeders.

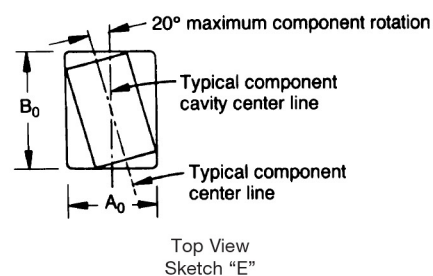
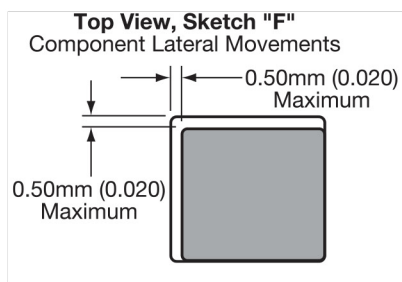
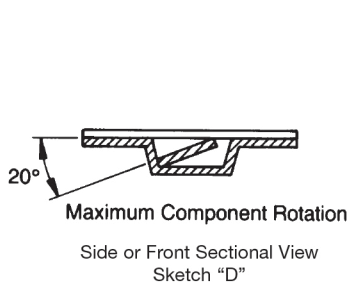

Surface Mount CapGuard®

Varistor/Capacitor Combination for EMI/Surge Suppression



AVX's surface mount CapGuard® products are designed to provide both transient voltage protection and EMI/RFI suppression for electronic circuits. CapGuards® are ideally suited to filter out EMI/RFI noise generated by switch mode power supplies or motors on DC lines or I/O lines in electronic circuits. With multilayer varistor (MLV) utilized in CapGuard® product, effective transient voltage protection is achieved to protect sensitive electronics from high voltage transients. The capacitor, on the other hand, absorbs high frequency noise on the line. The MLCC capacitors are designed with temperature stable X7R dielectric, allowing for wide temperature use with good capacitance stability. The surface mount CapGuards® are characterized with a very small form factor to minimize board space. The parts are assembled using high melting point solder (268°C solidus / 290°C liquidus) allowing for standard reflow processing during board level assembly without a risk of reflowing HMP solder.

FEATURES

- High Capacitance / EMI Filtering
- Bi-Directional Protection
- Fast Turn-On Time
- Multiple Strike Capability
- HMP Solder Termination
- 1210 EIA Case Size

TARGET APPLICATIONS

- Avionics
- Military
- I/O port protection
- EMI filtering with surge protection

GENERAL CHARACTERISTICS

Storage Temperature: -55°C to +125°C
 Operating Temperature: -55°C to +125°C

HOW TO ORDER

MV	10	18	J	104	M	A	A	1
Product Designation MLCC/Varistor (MLV)	Component Style 1210	Working Voltage 18 = 18V 26 = 26V 48 = 48V 60 = 60V	Transient Energy Rating J = 1.5 - 1.6J H = 1.2	Capacitance Code (2 significant digits + no. of zeros) Examples: 0.012µF = 123 0.047µF = 473 0.1µF = 104	Tolerance M = ±20%	Specification Code A = Standard	Termination HMP	Packaging T&R

PRODUCT OFFERING

Part Number	Operating Voltage (V)	Nominal Breakdown Voltage (V)	Breakdown Voltage Range (V)	Clamping Voltage (V)	Current for Clamping Voltage (Amp)	Transient Energy (J)	Peak Current (Amp)	Typical Capacitance (µF)
MV1018J123MAA1	18	25	23 - 28	42	5	1.6	500	0.012
MV1018J473MAA1	18	25	23 - 28	42	5	1.6	500	0.047
MV1018J104MAA1	18	25	23 - 28	42	5	1.6	500	0.1
MV1026H123MAA1	26	34.5	31 - 38	60	5	1.2	300	0.012
MV1026H473MAA1	26	34.5	31 - 38	60	5	1.2	300	0.047
MV1026H104MAA1	26	34.5	31 - 38	60	5	1.2	300	0.1
MV1048H123MAA1	48	62	55 - 69	100	5	1.2	250	0.012
MV1048H473MAA1	48	62	55 - 69	100	5	1.2	250	0.047
MV1048H104MAA1	48	62	55 - 69	100	5	1.2	250	0.1
MV1060J123MAA1	60	76	68 - 84	120	5	1.5	250	0.012
MV1060J473MAA1	60	76	68 - 84	120	5	1.5	250	0.047
MV1060J104MAA1	60	76	68 - 84	120	5	1.5	250	0.1

Surface Mount CapGuard®

Varistor/Capacitor Combination for EMI/Surge Suppression



TYPICAL VOLTAGE CURRENT RESPONSE

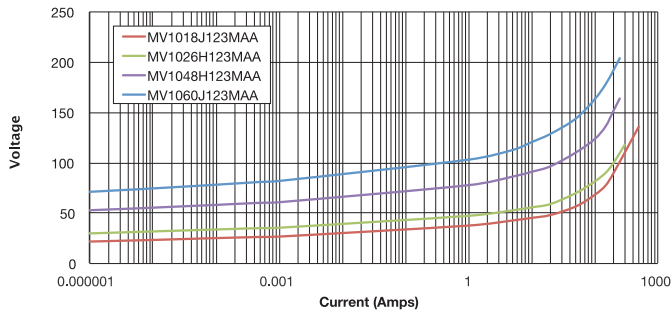

TYPICAL PULSE POWER DURATION

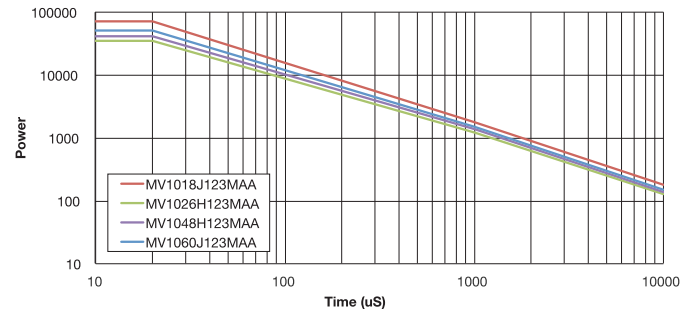

TYPICAL HIGH FREQUENCY CHARACTERISTICS

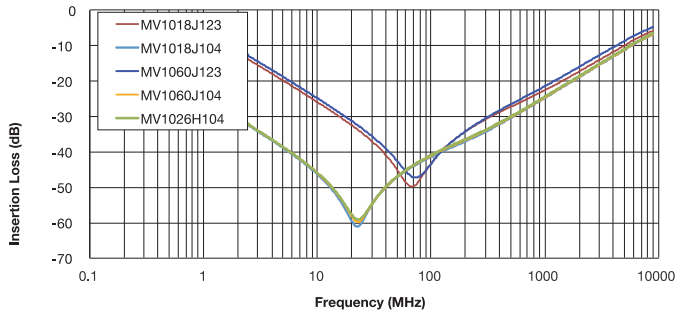

DIMENSIONS

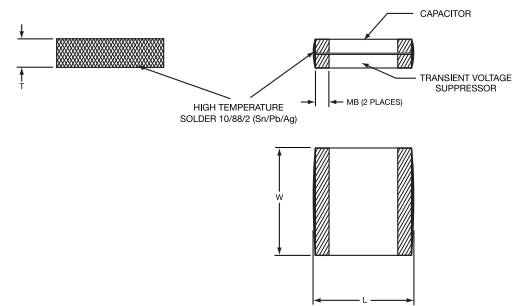

millimeters (inches)

Length (L)	Width (W)	Thickness (T)	Metallized Bands (MB)
3.302 ± 0.381 (0.130) ± (0.015)	2.540 ± 0.381 (0.100) ± (0.015)	2.794 (0.110) Max.	0.5 ± 0.25 (0.02) ± (0.01)

FEATURES

- To be used beneath a connector
- Provide an EMI filtered signal line between electronic modules
- Effective insertion loss from 1MHz up to ~ 1GHz
- Surface mount compatible

HOW TO ORDER

Not RoHS Compliant

XD	06	Z	F	0153	K	F
AVX Style	Size	Class	Voltage	Capacitance	Tolerance	Packaging
XD	03 06 01	C = NP0 Z = X7R	F = 200 J = 500	EIA code on 3 or 4 digits	NP0 F = ±1% G = ±2% J = ±5% K = ±10% X7R J = ±5% K = ±10% M = ±20%	SUFFIX Burn-in 100% 168H = T5 Burn-in 100% 48H = T3 No burn-in = -

STYLE & DIMENSIONS

millimeters (inches)

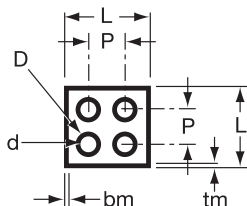

TYPES	L	P	D	d	bm maxi	Thickness maxi
XD07 (4 capacitors)	7.00 ± 0.15 (0.275 ± 0.006)	2.54 (0.100)	1.70 ± 0.15 (0.067 ± 0.006)	1.00 ± 0.10 (0.039 ± 0.0039)	0.3	2mm
XD06 (4 capacitors)	6.00 ± 0.15 (0.236 ± 0.006)	2.54 (0.100)	1.70 ± 0.15 (0.067 ± 0.006)	1.00 ± 0.10 (0.039 ± 0.0039)	0.3	2mm
XD03 (2 capacitors)	6.00 x 3.00 ± 0.15 (0.236 x 0.118 ± 0.006)	2.54 (0.100)	1.70 ± 0.15 (0.067 ± 0.006)	1.0 ± 0.10 (0.039 ± 0.0039)	0.3	1.5mm

Terminations: Silver – Palladium – Platinum, on 4 or only 2 sides of the array

CAPACITANCE VS VOLTAGE TABLE

Cap. Range (each cap.)	X7R		NP0	
	200VDC	500VDC	200VDC	500VDC
XD07...	33nF → 120nF	4.7nF → 18nF	470pF → 1500pF	220pF → 620pF
XD06...	15nF → 68nF	2.2nF → 10nF	220pF → 750pF	120pF → 330pF
XD03...	8.2nF → 39nF	1nF → 4.7nF	180pF → 390pF	82pF → 180pF

ELECTRICAL CHARACTERISTICS

Dielectric Class	X7R	NP0
Temperature Coefficient	$\Delta C/C \leq \pm 15\%$ (-55 +125°C)	0 ± 30ppm/°C
Climatic Category	55 / 125 / 56	55 / 125 / 56
Rated Voltage (UR)	200 VDC 500VDC	200VDC 500VDC
Test Voltage (Ue)	2 x UR 1.5 x UR	2 x UR 1.5 x UR
Tangent of Loss Angle - DF	$tg \delta \leq 250(10^{-4})$	$tg \delta \leq 15(10^{-4})$
Insulation Resistance	$C \leq 10nF = Ri \geq 100 \Omega$ $C > 10nF = Ri \times C \geq 1000s$	$Ri \geq 100 \Omega$

Baseline Management

A Dedicated Facility / BS9100 Requirements



Baseline Products – A Selection of Options

As a matter of course, AVX maintains a level of quality control that is sufficient to guarantee whatever reliability specifications are needed. However, AVX goes further. There are over 65 quality control and inspection operations that are available as options to a customer. Any number may be requested and written into a baseline process. The abbreviated list that follows indicates the breadth and thoroughness of available Q.C. services at AVX:

Ultrasonic Scanning
Destructive Physical Analysis (DPA)
X-Ray
Bondability Testing
Sorting and Matching to
Specification Limits
Temperature and Immersion
Cycling
Load/Humidity Life Testing
Dye Penetration Evaluation
100% Ceramic Sheet Inspection
Voltage Conditioning
Termination Pull Testing
Pre-encapsulation Inspection

Within the “specials” area, AVX accommodates a broad variety of customer needs. The AVX facilities are capable of developing and producing the most reliable and advanced MLCs available anywhere in the world today. Yet it is equally adept at making volume “custom” components that may differ only in markings or lead placement from the standard catalog part.

PROCUREMENT OF COMPONENTS OF BS9100 (CH/CV RANGE 50-500V)

The manufacturing facilities have ISO9001 approval. Customers requiring BS9100 approved components are requested to follow these steps:

1. The customer shall submit a specification for the required components to AVX for approval. Once agreed a Customer Detail Specification (CDS) number will be allocated by AVX to this specification. This number with its current revision must be quoted at the time of order placement.
2. If the customer has no specification, then AVX will supply a copy of the standard CDS

Stretching the Limits

AVX Advanced Products are developed to meet the extraordinary needs of specific applications. Requirements may include: low ESR, low ESL, voltages up to 10's of thousands, advanced decoupling designs for frequencies up to 10's of megahertz, temperatures up to 200°C, extremely high current discharge, ability to perform in high radiation or toxic atmospheres, or minimizing piezoelectric effect in high vibration environments.

In addition, solving customer packaging problems, aside from addressing circuit problems, is available. Special lead frames for high current or special mounting requirements are examples. Multiple ceramic chip package designs per customer requirements are also available.

AVX Advanced Products always begin with a joint development program involving AVX and the customer. In undersea cable components, for example, capacitance and impedance ratings had to be maintained within 1% over the multi-year life of the system. In this case, AVX Advanced Products not only met the parametric requirements of the customer, but accelerated life testing of 3,500 units indicated an average life expectancy of over 100,000 years.

Baseline Program Management

Baseline Program Management has been AVX's forte over the years. This is both a product and a service function designed to provide the customer the full capabilities of AVX in meeting their program requirements.

for the customer's approval and signature. As in 1 above, when agreed this CDS number must be quoted at order entry. In the event of agreement not being reached the component cannot be supplied to BS9100.

For assistance contact: EMAP
Specification Engineering Dept. AVX
Ltd. Coleraine, Northern Ireland
Telephone ++44 (0)28703 44188, Fax ++44
(0)28703 55527

AVX has had Baseline and Program Management in the following major systems:

- AT&T Undersea Cable
- Minuteman
- Peacekeeper
- STC Undersea Cable
- CIT Undersea Cable
- Raytheon-Hawk Missile
- Trident
- Small Missile Program
- Northrop - Peacekeeper
- Sparrow Program
- Space Station
- European Space Agency (ESA)
- Commercial Satellite Program
- Arianne 4 & 5
- EuroFighter (Typhoon)
- EH101 (Merlin)

AVX technical personnel stand ready to answer any questions and provide any information required on your programs from the most exotic Hi-Rel part to the simplest variation on a standard. Put the experience, technology and facilities of the leading company in multilayer ceramics to work for you. No other source offers the unique combination of capability and commitment to advanced application specific components.

PACKAGING

Unless otherwise stated in the appropriate data sheet parts are supplied in a waffle pack.



Examples of Special Packaging and Custom Lead Configurations from AVX Advanced Products

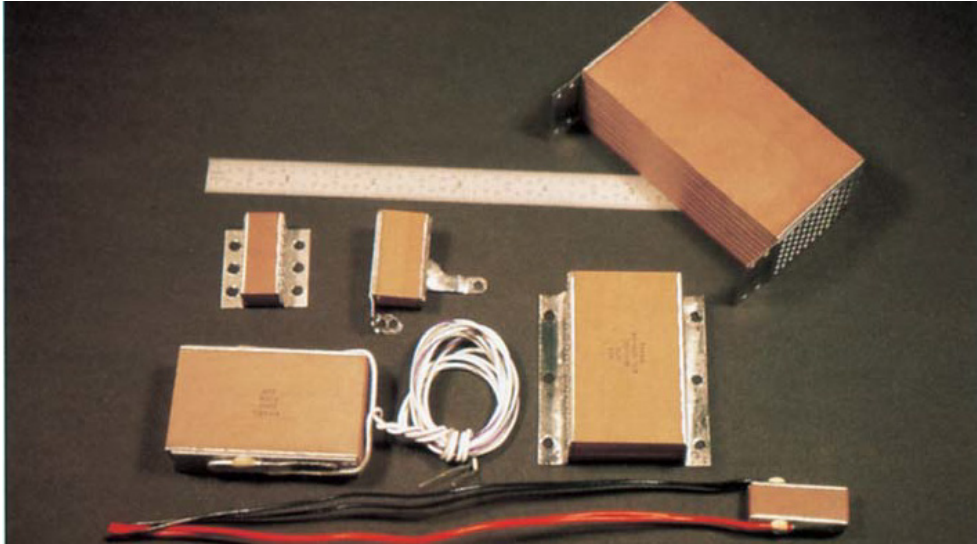

Custom Lead Configurations. . .

optimum 3D packaging, high current applications and high reliability stress relief mounting.

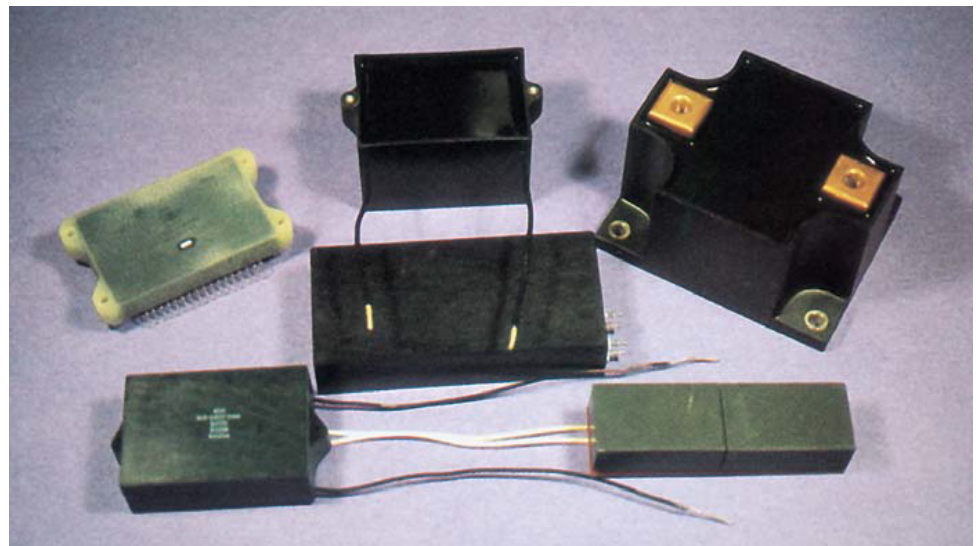

Custom Packaging. . .

eliminate reliability concerns with multiple component assembly.

Many other innovations are available from AVX Advanced Products. Let them apply these ideas to your application specific programs.



A KYOCERA GROUP COMPANY

FOLLOW US:

VISIT US AT

A light gray world map is centered in the lower half of the page. It shows the outlines of continents and major landmasses.

North America

Tel: +1 864-967-2150

Europe

Tel: +44 1276-697000

Asia

Tel: +65 6286-7555

Central America

Tel: +55 11-46881960

Japan

Tel: +81 740-321250