



APFA2507R9Y2C

2.5 x 0.7 mm Right Angle SMD Chip LED Lamp

DESCRIPTIONS

- The Hyper Red source color devices are made with AlGaInP on GaAs substrate Light Emitting Diode
- The Super Bright Yellow device is made with AlGaInP (on GaAs substrate) light emitting diode chip
- Electrostatic discharge and power surge could damage the LEDs
- It is recommended to use a wrist band or anti-electrostatic glove when handling the LEDs
- All devices, equipments and machineries must be electrically grounded

FEATURES

- 2.5 x 1.0 x 0.7 mm right angle SMD LED, 0.7 mm thickness
- Low power consumption
- Wide viewing angle
- Ideal for backlight and indicator
- Package: 3000 pcs / reel
- Moisture sensitivity level: 3
- Tinned pads for improved solderability
- Halogen-free
- RoHS compliant

APPLICATIONS

- Backlight
- Status indicator
- Home and smart appliances
- Wearable and portable devices
- Healthcare applications

ATTENTION

Observe precautions for handling electrostatic discharge sensitive devices



PACKAGE DIMENSIONS

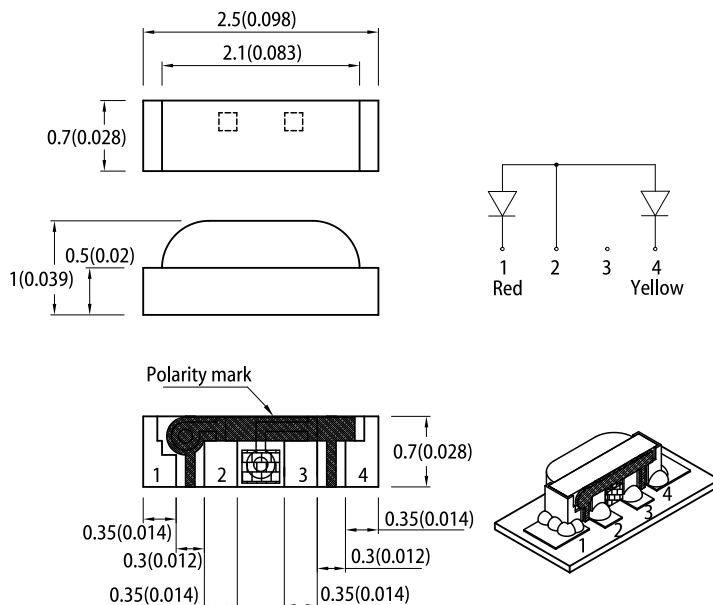

RECOMMENDED SOLDERING PATTERN

(units : mm; tolerance : ± 0.1)

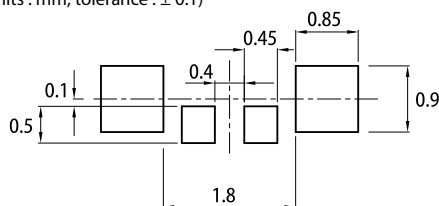

Notes:

1. All dimensions are in millimeters (inches).
2. Tolerance is $\pm 0.15(0.006")$ unless otherwise noted.
3. The specifications, characteristics and technical data described in the datasheet are subject to change without prior notice.
4. The device has a single mounting surface. The device must be mounted according to the specifications.
5. For right angle SMD LEDs, the solder stencil should be at least 5mil in thickness, to prevent poor solder wetting due to insufficient solder paste.

SELECTION GUIDE

Part Number	Emitting Color (Material)	Lens Type	Iv (mcd) @ 20mA ^[2]		Viewing Angle ^[1]
			Min.	Typ.	2θ1/2
APFA2507R9Y2C	■ Hyper Red (AlGaInP)	Water Clear	80	110	130°
			*20	*40	
	■ Super Bright Yellow (AlGaInP)		80	130	
			*80	*130	

Notes:

1. θ1/2 is the angle from optical centerline where the luminous intensity is 1/2 of the optical peak value.
2. Luminous intensity / luminous flux: +/-15%.

* Luminous intensity value is traceable to CIE127-2007 standards.

ELECTRICAL / OPTICAL CHARACTERISTICS at $T_A=25^\circ\text{C}$

Parameter	Symbol	Emitting Color	Value		Unit
			Typ.	Max.	
Wavelength at Peak Emission $I_F = 20\text{mA}$	λ_{peak}	Hyper Red Super Bright Yellow	630 590	-	nm
Dominant Wavelength $I_F = 20\text{mA}$	$\lambda_{\text{dom}}^{[1]}$	Hyper Red Super Bright Yellow	621 590	-	nm
Spectral Bandwidth at 50% Φ REL MAX $I_F = 20\text{mA}$	$\Delta\lambda$	Hyper Red Super Bright Yellow	20 20	-	nm
Capacitance	C	Hyper Red Super Bright Yellow	25 20	-	pF
Forward Voltage $I_F = 20\text{mA}$	$V_F^{[2]}$	Hyper Red Super Bright Yellow	2.0 2.0	2.5 2.5	V
Reverse Current ($V_R = 5\text{V}$)	I_R	Hyper Red Super Bright Yellow	-	10 10	μA

Notes:

1. The dominant wavelength (λ_d) above is the setup value of the sorting machine. (Tolerance $\lambda_d: \pm 1\text{nm}$.)

2. Forward voltage: $\pm 0.1\text{V}$.

3. Wavelength value is traceable to CIE127-2007 standards.

4. Excess driving current and / or operating temperature higher than recommended conditions may result in severe light degradation or premature failure.

ABSOLUTE MAXIMUM RATINGS at $T_A=25^\circ\text{C}$

Parameter	Symbol	Value		Unit
		Hyper Red	Super Bright Yellow	
Power Dissipation	P_D	75	75	mW
Reverse Voltage	V_R	5	5	V
Junction Temperature	T_j	115	115	$^\circ\text{C}$
Operating Temperature	T_{op}	-40 to +85		$^\circ\text{C}$
Storage Temperature	T_{stg}	-40 to +85		$^\circ\text{C}$
DC Forward Current	I_F	30	30	mA
Peak Forward Current	$I_{\text{FM}}^{[1]}$	195	175	mA
Electrostatic Discharge Threshold (HBM)	-	3000	3000	V

Notes:

1. 1/10 Duty Cycle, 0.1ms Pulse Width.

2. Relative humidity levels maintained between 40% and 60% in production area are recommended to avoid the build-up of static electricity – Ref JEDEC/JESD625-A and JEDEC/J-STD-033.

TECHNICAL DATA

RELATIVE INTENSITY vs. WAVELENGTH

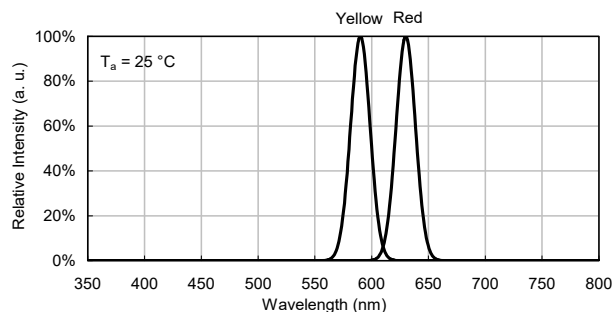

SPATIAL DISTRIBUTION

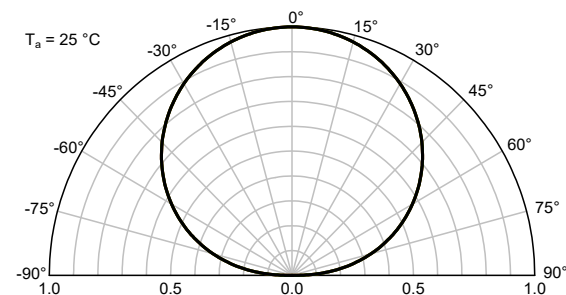

HYPER RED

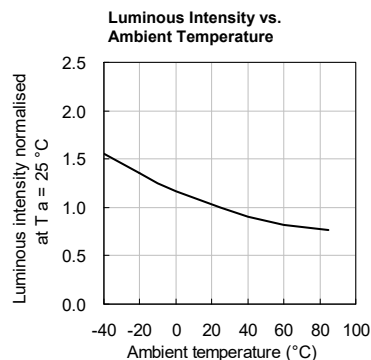
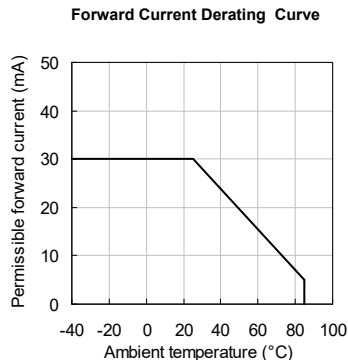
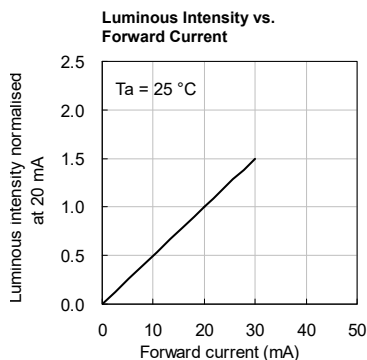
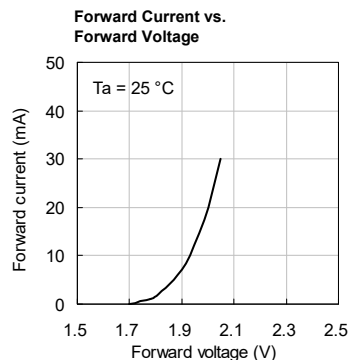

SUPER BRIGHT YELLOW

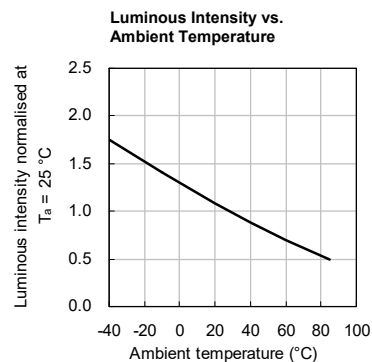
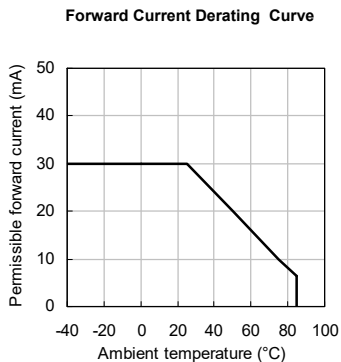
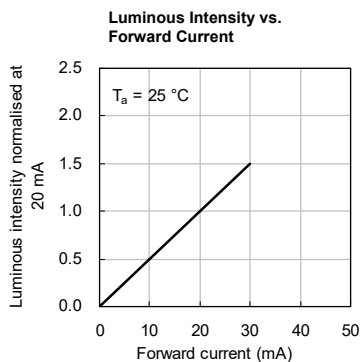
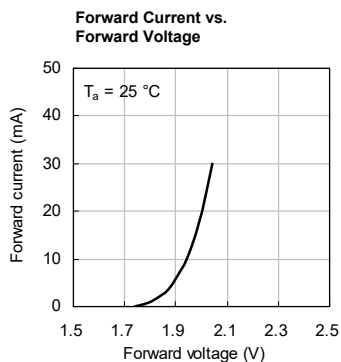

REFLOW SOLDERING PROFILE for LEAD-FREE SMD PROCESS

TAPE SPECIFICATIONS (units : mm)

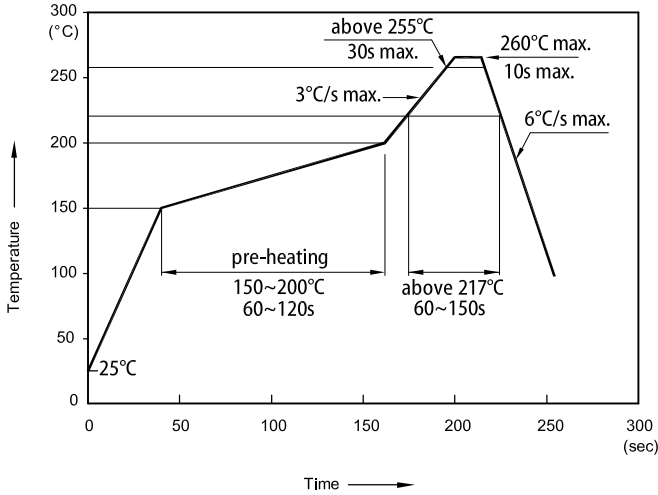

- Notes:
1. Don't cause stress to the LEDs while it is exposed to high temperature.
 2. The maximum number of reflow soldering passes is 2 times.
 3. Reflow soldering is recommended. Other soldering methods are not recommended as they might cause damage to the product.

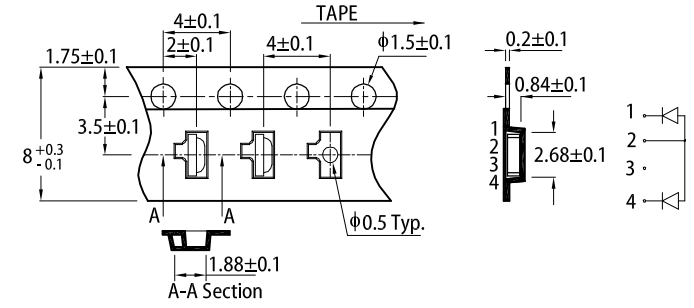

REEL DIMENSION (units : mm)

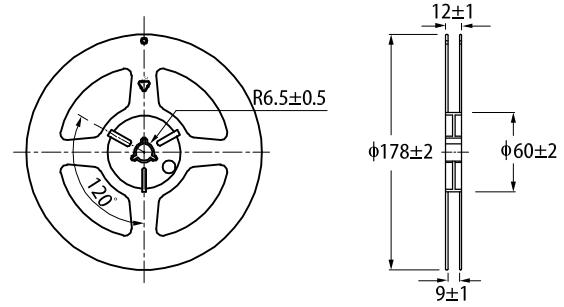

PACKING & LABEL SPECIFICATIONS

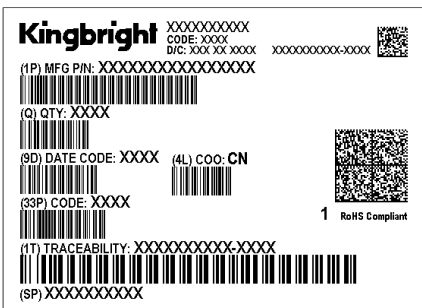
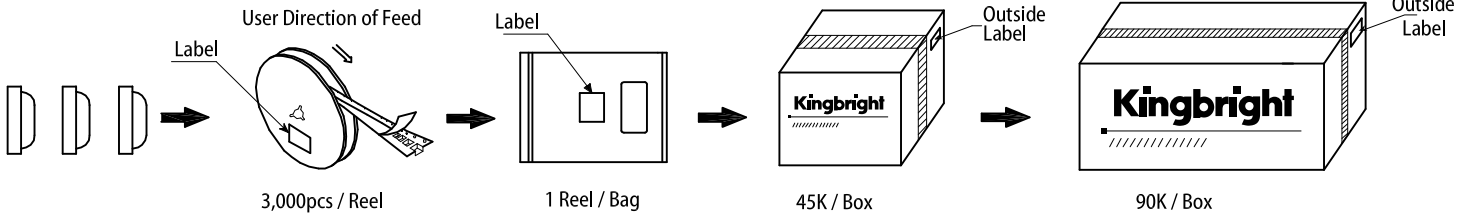

PRECAUTIONARY NOTES

1. The information included in this document reflects representative usage scenarios and is intended for technical reference only.
2. The part number, type, and specifications mentioned in this document are subject to future change and improvement without notice. Before production usage customer should refer to the latest datasheet for the updated specifications.
3. When using the products referenced in this document, please make sure the product is being operated within the environmental and electrical limits specified in the datasheet. If customer usage exceeds the specified limits, Kingbright will not be responsible for any subsequent issues.
4. The information in this document applies to typical usage in consumer electronics applications. If customer's application has special reliability requirements or have life-threatening liabilities, such as automotive or medical usage, please consult with Kingbright representative for further assistance.
5. The contents and information of this document may not be reproduced or re-transmitted without permission by Kingbright.
6. All design applications should refer to Kingbright application notes available at <https://www.KingbrightUSA.com/ApplicationNotes>