



A New Direction in Mixed-Signal

January 2014

XRP7720/7724/7725EVB-DEMO-1

Quad Channel Digital PWM/PFM Demo Board

Programmable Power Management System

Rev. 2.0.0

GENERAL DESCRIPTION

The XRP7720/7724/7725EVB-DEMO-1 board is a complete, four channel, power system. It provides 3.3V, 2.5V 1.5V and 1V at a maximum of 3A, 3A, 5A and 10A loads respectively. The 1.5V and 1V supplies can be adjusted in 2.5mV increments, the 2.5V supply in 5mV increments, and the 3.3V supply is adjustable in 10mV increments. The order and ramp rates for each supply can be programmed to accommodate any sequencing requirement. All power supply operations can be controlled over an I²C interface. Faults, output voltages and currents can also be monitored. Two GPIO and three PSIO signals are available and can be programmed to provide a variety of functions. Unused GPIO/PSIO pins can be programmed as I/O expansion for a microcontroller. The board is supported by PowerArchitect™ 5.1 and plugs directly onto the Exar Communications Module (XRP77xxEVB-XCM).

EVALUATION BOARD MANUAL

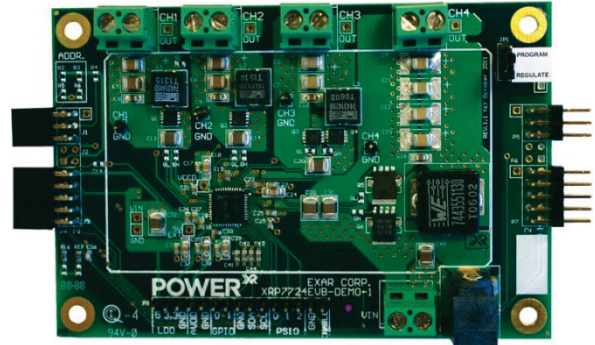

XRP7724EVB-DEMO-1

FEATURES

- **XRP7720/XRP7724/XRP7725 Programmable Controller**
- **4 Channel Power System**
- **Wide Input Voltage Range: 5.5V-18V**
- **I²C Interface**
 - Programming
 - Monitoring
 - Control



A New Direction in Mixed-Signal

January 2014

XRP7720/7724/7725EVB-DEMO-1

Quad Channel Digital PWM/PFM Demo Board Programmable Power Management System

Rev. 2.0.0

EVALUATION BOARD SCHEMATICS

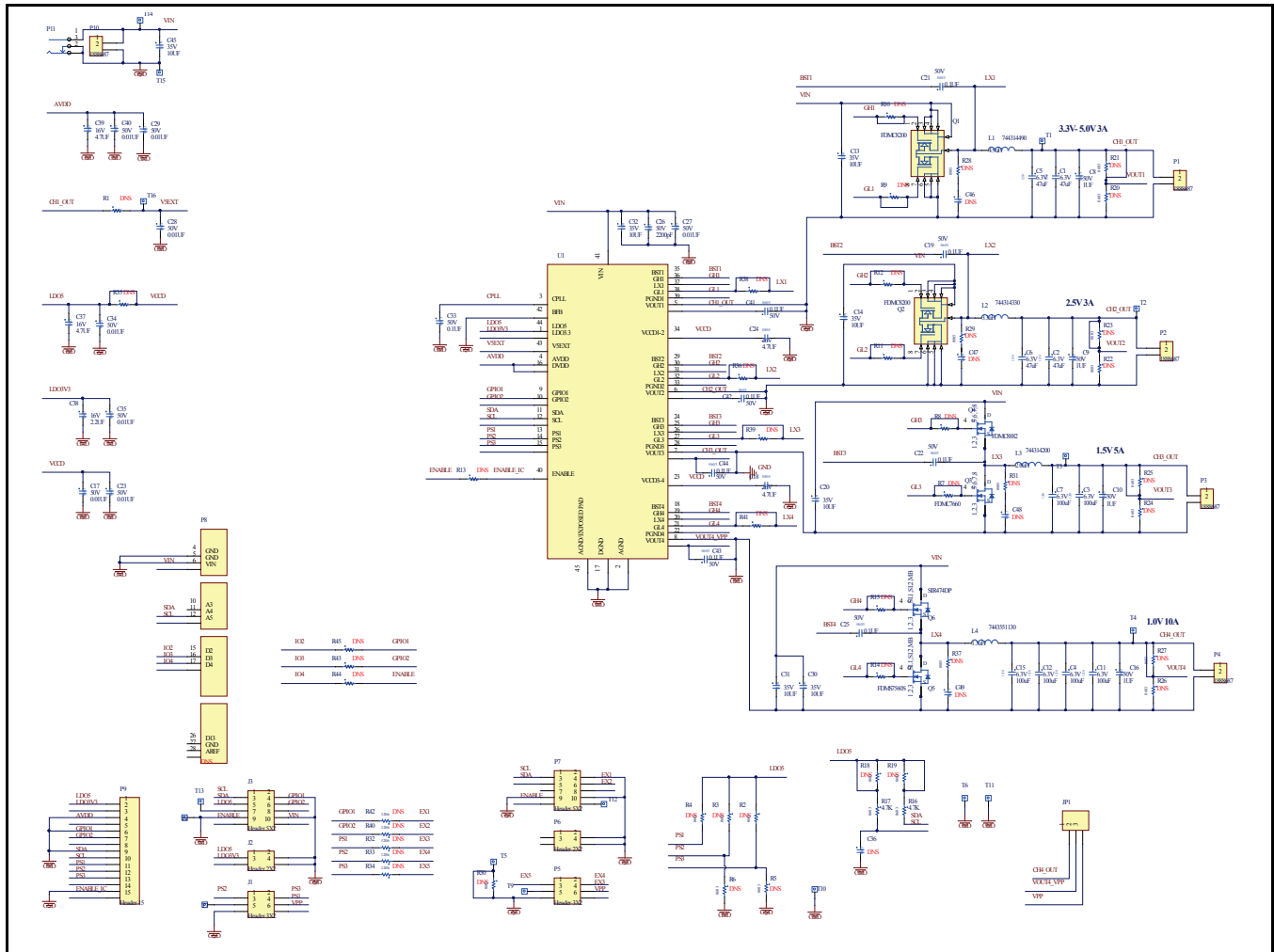

Figure 1: XRP7720 /7724/7725 Evaluation Board Schematics

XRP7720-DEV PIN ASSIGNMENT

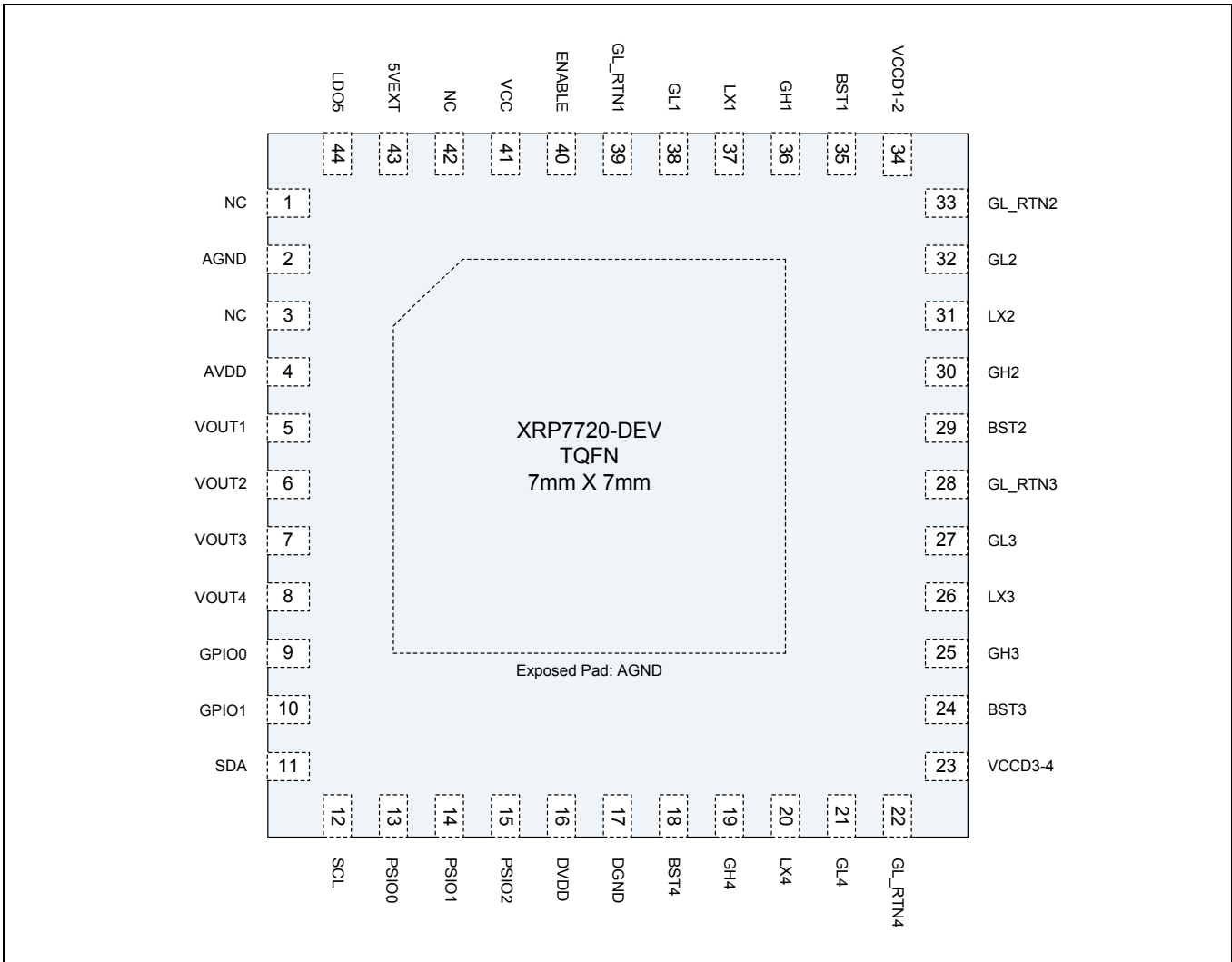

Figure 2: XRP7720-DEV Pin Assignment

XRP7720-DEV PIN DESCRIPTION

Name	Pin Number	Description
VCC	41	Input voltage. Place a decoupling capacitor close to the pin. This input is used in UVLO fault generation.
DVDD	16	1.8V supply for digital circuitry. Connect pin to AVDD. Place a decoupling capacitor close to the pin.
VCCD1-2 VCCD3-4	23,34	Gate Drive supply. Two independent gate drive supply pins where pin 34 supplies drivers 1 and 2 and pin 23 supplies drivers 3 & 5. One of the two pins must be connected to the LDO5 pin to enable two power rails initially. It is recommended that the other VCCD pin be connected to the output of a 5V switching rail(for improved efficiency or for driving larger external FETs), if available, otherwise this pin may also be connected to the LDO5 pin. A bypass capacitor (>1uF) to PAD is recommended for each VCCD pin with the pin(s) connected to LDO5 with shortest possible etch.
AGND	2	Analog ground pin. This is the small signal ground connection.



A New Direction in Mixed-Signal

XRP7720/7724/7725EVB-DEMO-1

Quad Channel Digital PWM/PFM Demo Board Programmable Power Management System

Name	Pin Number	Description
GL_RTN1-4	39,33, 28,22	Ground connection for the low side gate driver. This should be routed as a signal trace with GL. Connect to the source of the low side MOSFET.
GL1-GL4	38,32, 27,21	Output pin of the low side gate driver. Connect directly to the gate of an external N-channel MOSFET.
GH1-GH4	36,30, 25,19	Output pin of the high side gate driver. Connect directly to the gate of an external N-channel MOSFET.
LX1-LX4	37,31, 26,20	Lower supply rail for the GH high-side gate driver. Connect this pin to the switching node at the junction between the two external power MOSFETs and the inductor. These pins are also used to measure voltage drop across bottom MOSFETs in order to provide output current information to the control engine.
BST1-BST4	35,29, 24,18	High side driver supply pin(s). Connect BST to the external capacitor as shown in the Typical Application Circuit on page 5. The high side driver is connected between the BST pin and LX pin and delivers the BST pin voltage to the high side FET gate each cycle.
GPI0-GPI01	9,10	These pins can be configured as inputs or outputs to implement custom flags, power good signals, enable/disable controls and synchronization to an external clock.
PSIO0-PSIO2	13,14,15	Open drain, these pins can be used to control external power MOSFETs to switch loads on and off, shedding the load for fine grained power management. They can also be configured as standard logic outputs or inputs just as any of the GPIOs can be configured, but as open drains require an external pull-up when configured as outputs.
SDA, SCL	11,12	SMBus/I ² C serial interface communication pins. These pins can be configured open drain or pseudo-TTL requiring a pull-up resistor.
VOUT1-VOUT4	5,6,7,8	Connect to the output of the corresponding power stage. The output is sampled at least once every switching cycle
LDO5	44	Output of a 5V LDO. This is a micro power LDO that can remain active while the rest of the IC is in the stand-by mode. This LDO is also used to power the internal Analog Blocks.
ENABLE	40	If ENABLE is pulled high or allowed to float high, the chip is powered up (logic is reset, registers configuration loaded, etc.). The pin must be held low for the XRP7724 to be placed into shutdown. Active channels will automatically be ramped down, if desired, prior to the disabling of the chip.
DGND	17	Digital ground pin. This is the logic ground connection, and should be connected to the ground plane close to the PAD.
NC	1,3,42	No Connect

XRP7724/XRP7725 PIN ASSIGNMENT

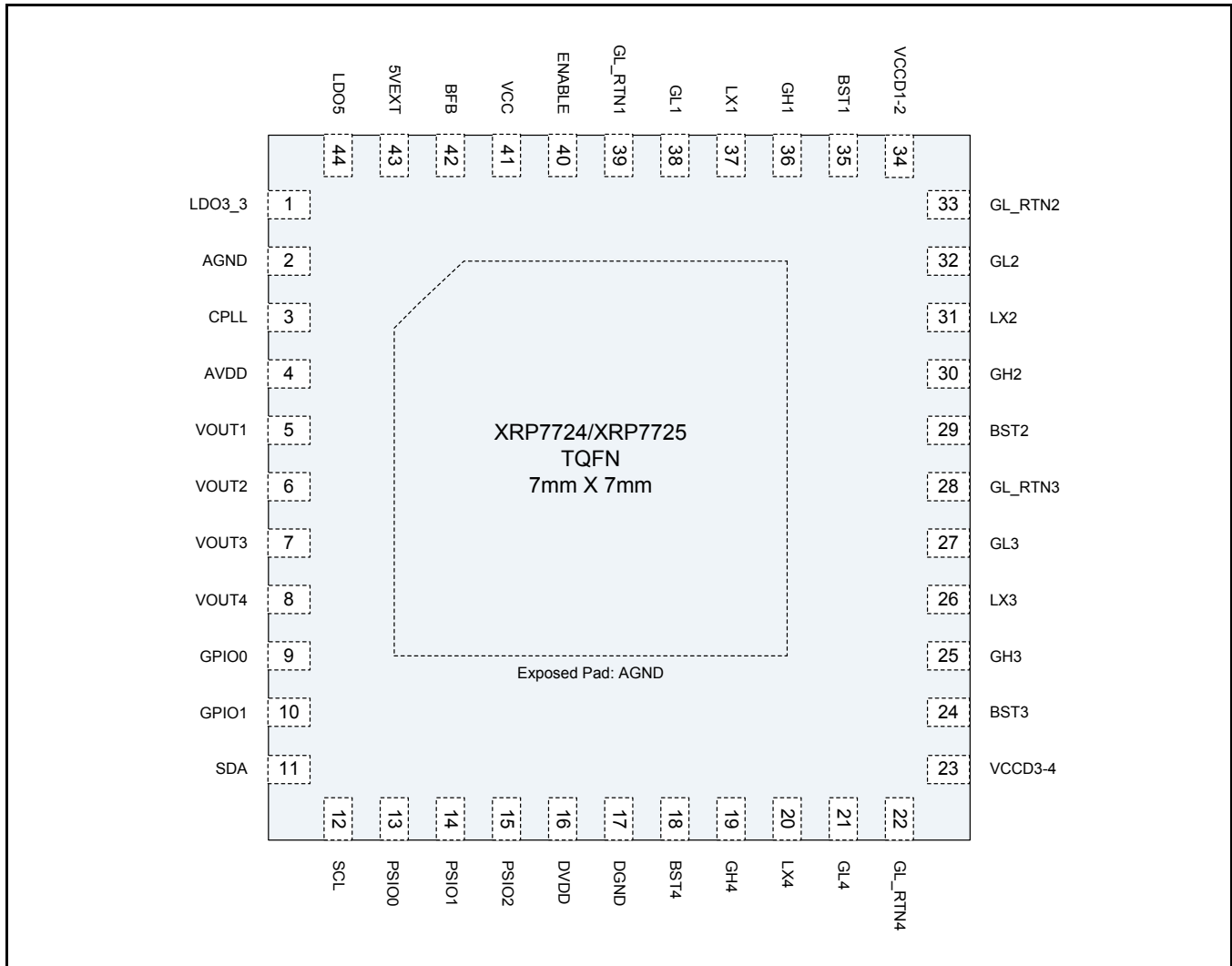

Figure 3: XRP7724/XRP7725 Pin Assignment

XRP7724/XRP7725 PIN DESCRIPTION

Name	Pin Number	Description
VCC	41	Input voltage. Place a decoupling capacitor close to the pin. This input is used in UVLO fault generation.
DVDD	16	1.8V supply for digital circuitry. Connect pin to AVDD. Place a decoupling capacitor close to the pin.
VCCD1-2 VCCD3-4	23,34	Gate Drive supply. Two independent gate drive supply pins where pin 34 supplies drivers 1 and 2 and pin 23 supplies drivers 3 & 5. One of the two pins must be connected to the LDO5 pin to enable two power rails initially. It is recommended that the other VCCD pin be connected to the output of a 5V switching rail (for improved efficiency or for driving larger external FETs), if available, otherwise this pin may also be connected to the LDO5 pin. A bypass capacitor (>1uF) to PAD is recommended for each VCCD pin with the pin(s) connected to LDO5 with shortest possible etch.
AGND	2	Analog ground pin. This is the small signal ground connection.
GL_RTNN-4	39,33, 28,22	Ground connection for the low side gate driver. This should be routed as a signal trace with GL. Connect to the source of the low side MOSFET.



A New Direction in Mixed-Signal

XRP7720/7724/7725EVB-DEMO-1

Quad Channel Digital PWM/PFM Demo Board

Programmable Power Management System

Name	Pin Number	Description
GL1-GL4	38,32, 27,21	Output pin of the low side gate driver. Connect directly to the gate of an external N-channel MOSFET.
GH1-GH4	36,30, 25,19	Output pin of the high side gate driver. Connect directly to the gate of an external N-channel MOSFET.
LX1-LX4	37,31, 26,20	Lower supply rail for the GH high-side gate driver. Connect this pin to the switching node at the junction between the two external power MOSFETs and the inductor. These pins are also used to measure voltage drop across bottom MOSFETs in order to provide output current information to the control engine.
BST1-BST4	35,29, 24,18	High side driver supply pin(s). Connect BST to the external capacitor as shown in the Typical Application Circuit on page 5. The high side driver is connected between the BST pin and LX pin and delivers the BST pin voltage to the high side FET gate each cycle.
GPIO-GPIO1	9,10	These pins can be configured as inputs or outputs to implement custom flags, power good signals, enable/disable controls and synchronization to an external clock.
PSIO0-PSIO2	13,14,15	Open drain, these pins can be used to control external power MOSFETs to switch loads on and off, shedding the load for fine grained power management. They can also be configured as standard logic outputs or inputs just as any of the GPIOs can be configured, but as open drains require an external pull-up when configured as outputs.
SDA, SCL	11,12	SMBus/I ² C serial interface communication pins. These pins can be configured open drain or pseudo-TTL requiring a pull-up resistor.
VOUT1-VOUT4	5,6,7,8	Connect to the output of the corresponding power stage. The output is sampled at least once every switching cycle
LDO5	44	Output of a 5V LDO. This is a micro power LDO that can remain active while the rest of the IC is in the stand-by mode. This LDO is also used to power the internal Analog Blocks.
LDO3_3	1	Output of the 3.3V standby LDO. This is a micro power LDO that can remain active while the rest of the IC is in shutdown.
ENABLE	40	If ENABLE is pulled high or allowed to float high, the chip is powered up (logic is reset, registers configuration loaded, etc.). The pin must be held low for the XRP7724 to be placed into shutdown. Active channels will automatically be ramped down, if desired, prior to the disabling of the chip.
BFB	42	Input from the 15V output created by the external boost supply. When this pin goes below a pre-defined threshold, a pulse is created on the low side drive to charge this output back to the original level. If not used, this pin should be connected to GND.
DGND	17	Digital ground pin. This is the logic ground connection, and should be connected to the ground plane close to the PAD.
CPLL	3	PLL compensation capacitor

ORDERING INFORMATION

Refer to XRP7720/XRP7724/XRP7725 datasheets and/or www.exar.com for exact and up to date ordering information.

USING THE EVALUATION BOARD

INPUT VOLTAGE RANGE

The input voltage range of these boards is from 5.5V to 18V. The power components have been optimized for a 12V input rail. When running the board at an input voltage other than 12V, use PowerArchitect™ 5.1 to evaluate the system performance.

I²C INTERFACE

The controller employs a standard I²C interface. Pull-ups for the I²C signals are included on the demo board.

OPERATING THE EVALUATION BOARD

The demo board is designed to be powered from either an AC/DC wall wart (the output voltage must be in the range of the controller VCC specification – 5.5V to 18V) connected to the barrel connector, or a test bench DC power supply (the voltage must be in the range of the controller VCC specification – 5.5V to 18V) connected to the Vin phoenix connector (the positive side is indicated with VIN text in silkscreen. The proper connection is indicated in the evaluation board connections section below).

BRING UP PROCEDURE

Plug the demo board to the XCM as shown below.

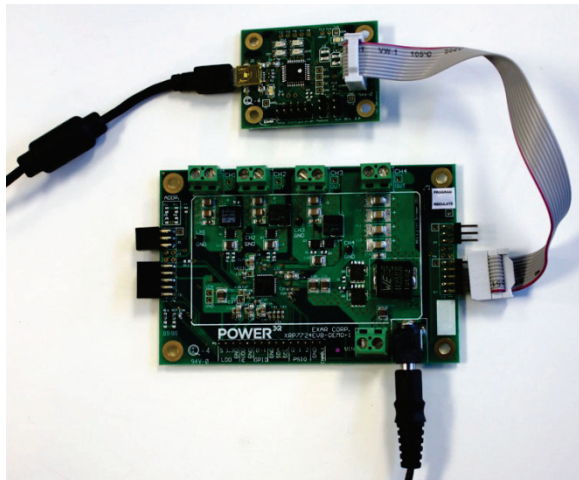

Load the PowerArchitect™ 5.1 software and run it.

After selecting the proper family (Chips) and the device (XRP7720, XRP7724, or XRP7725), select the “Get Started with the EVB-DEMO-1” option when prompted as shown below.

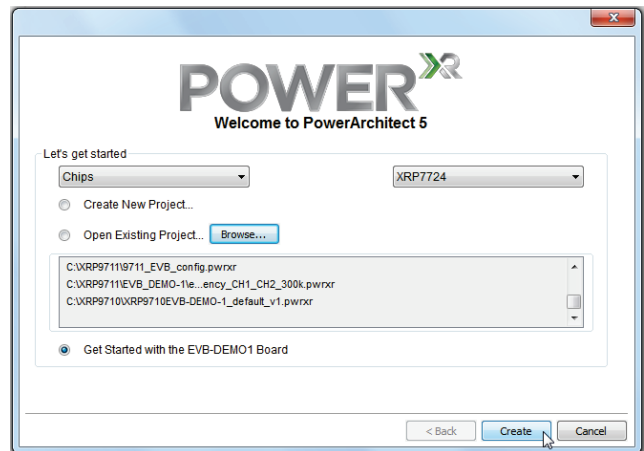

When done, click “Create”. PowerArchitect™ 5.1 will load the default configuration automatically.

Apply Power to the board. Please refer to the sections above on how to properly supply power to the board and what voltage range to use.

Turn on the Power supply.

Insert the USB cable into the computer and the XCM board.

Go to the Tools tab in PowerArchitect™ 5.1 and select Boards. The software will identify communication ports where it found the XCM board. Select the port.

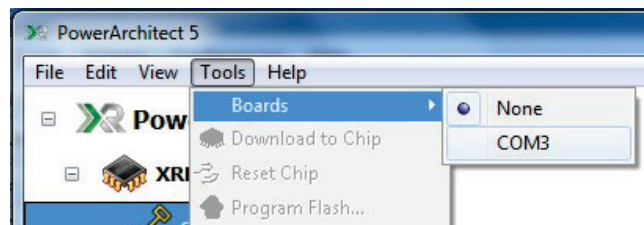

PowerArchitect™ 5.1 is now communicating with XCM which is indicated in the lower left corner.

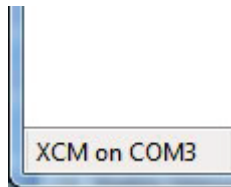

Programming the Configuration onto XRP7720-DEV/XRP7724/XRP7725

To program a configuration go to the Tools tab in PowerArchitect™ 5.1 and select Program Flash.

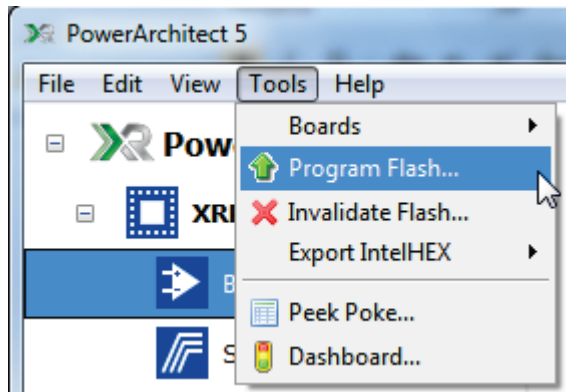

The program Flash window will appear.

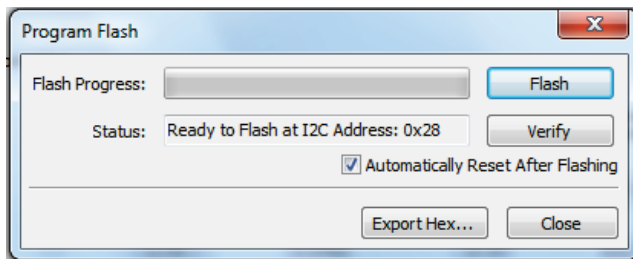

Click the Flash button.

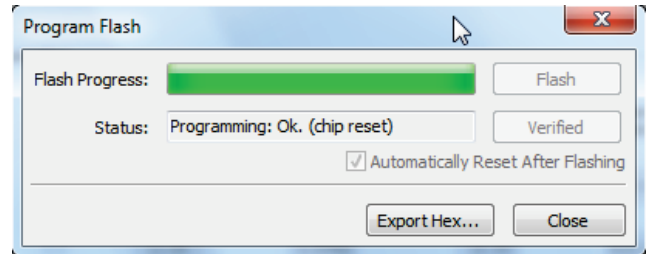

PowerArchitect™ 5.1 will go through the process of loading configuration in the flash. Once it has successfully completed the task, it will report the outcome as seen above and reset the device if "Automatically Reset After Flashing" box checked (default option).

Close the window.

Note that the boards will be pre-loaded with the default configuration.

Regulation

To enable channel regulation go to the Tools tab in PowerArchitect™ 5.1 and select Dashboard.

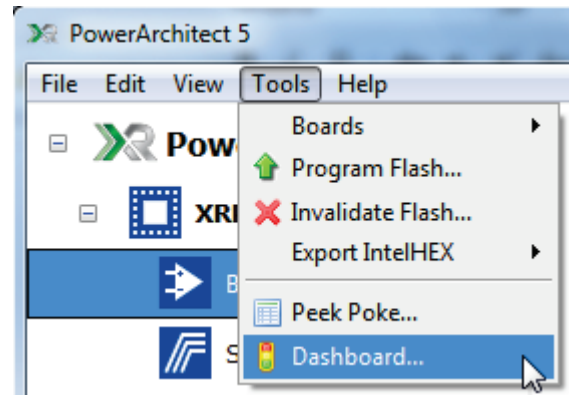

In Dashboard turn Group 1 and Group 2 on. The configuration groups channel 1, channel 2, and LDO3.3* into Group 1, and channels 3 and 4 into Group 2. The channels are now in regulation as indicated by Vout readings as well as the in-regulation indicators.

Note*: Not available in XRP7720EVB-DEMO-1

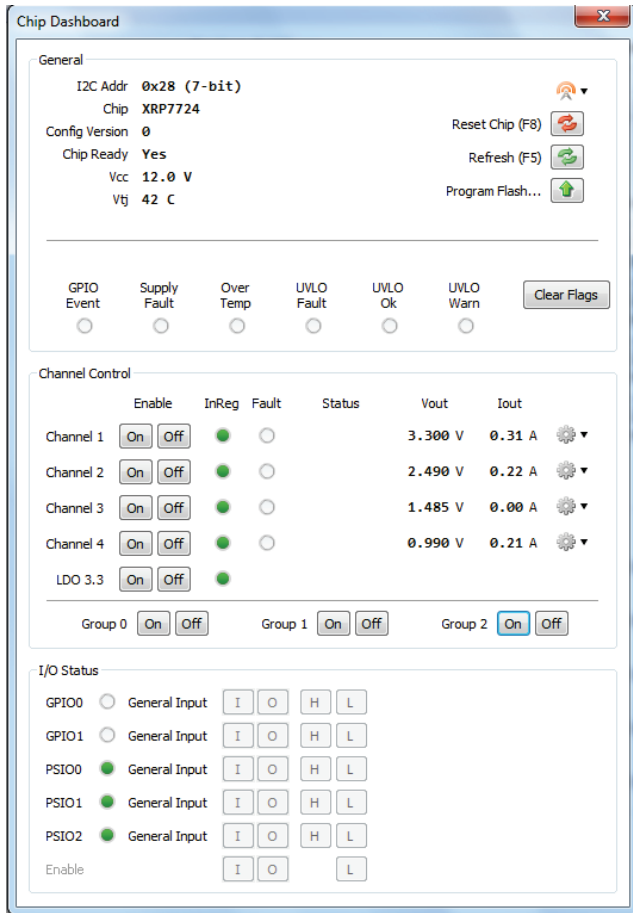

EVALUATION BOARD CONNECTIONS

The following picture illustrates how Vin supplied from a test bench DC power supply and instruments attached to the outputs would be connected to the demo board.

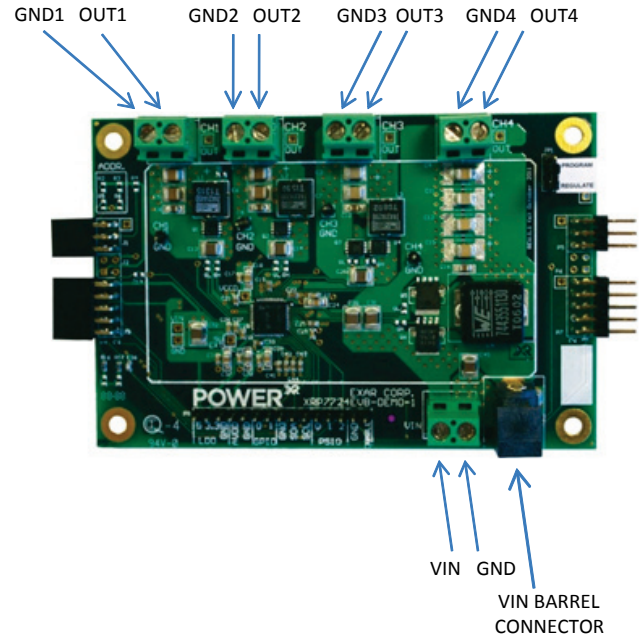

Channels can be turned on/off individually if desired.

Note: Make sure there is a jumper shorting JP1 pins 1 and 2 installed on your board. Channel 4 will not regulate without it.

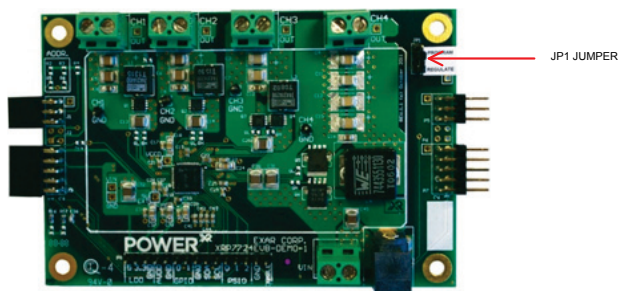

Evaluation Board Schematic

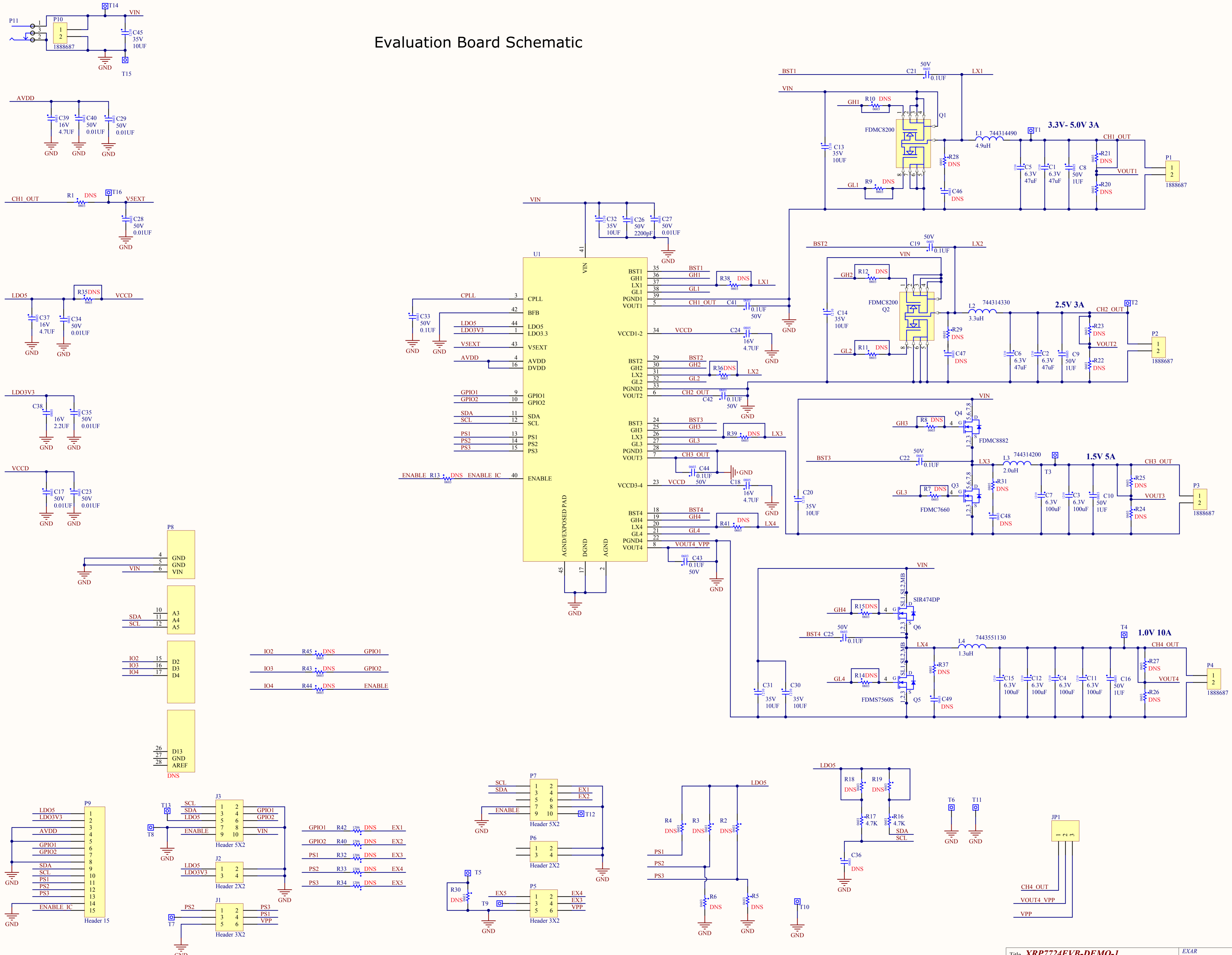

BILL OF MATERIAL

Ref.	Qty	Manufacturer	Part Number	Size	Component
U1	1	Exar Corp.	XRP7720-DEV /XRP7724/XRP7725	TQFN44	2nd Generation 4Ch. Sw. Controller
Q1,Q2	2	FAIRCHILD	FDMC8200	Power 33	Dual N-Channel Power Trench MOSFET
Q3	1	FAIRCHILD	FDMC7660	Power 33	N-Channel Power Trench MOSFET
Q4	1	FAIRCHILD	FDMC8882	MLP 3.3X3.3	N-Channel Power Trench MOSFET
Q5	1	FAIRCHILD	FDMS7560S	Power 56	N-Channel Power Trench SyncFET
Q6	1	Vishay Siliconix	SIR474DP	PowerPAK SO- 8	N-Ch. 30-V (D-S) MOSFET
L1	1	WURTH ELEKTRONIK	744314490	7.0x6.9mm	Inductor 4.9uH, 14.5mΩ, 6.5A
L2	1	WURTH ELEKTRONIK	744314330	7.0x6.9mm	Inductor 3.3uH, 9.0mΩ, 9.0A
L3	1	WURTH ELEKTRONIK	744314200	7.0x6.9mm	Inductor 2.0uH, 5.85mΩ, 11.5A
L4	1	WURTH ELEKTRONIK	7443551130	13.2X12.8mm	Inductor 1.3uH, 1.8mΩ, 25A
C1,C2,C5,C6	4	MURATA CORP.	GRM32ER70J476KE20L	1210	CAP CER 47uF, 6.3V, X7R, 10%
C3,C4,C7,C11,C12,C15	6	MURATA CORP.	GRM32ER60J107M20L	1210	CAP CER 100uF, 6.3V, X5R, 20%
C8,C9,C10,C16	4	MURATA CORP.	GRM21BR71H105KA12L	0805	CAP CER 1.0uF, 50V, X7R, 10%
C13,C14,C20,C30,C31,C32,C45	7	MURATA CORP.	GRM32ER7YA106KA12L	1210	CAP CER 10uF, 35V,X7R, 10%
C17,C23,C27-C29,C34,C35**,C40	8	MURATA CORP.	GRM188R71H103KA01D	0603	CAP CER 0.01uF,50V,X7R,10%
C18,C24,C37,C39	4	MURATA CORP.	GRM21BR71C475KA73	0805	CAP CER 4.7uF, 16V,X7R,10%
C19,C21,C22,C25,C33,C41-C44	9	MURATA CORP.	GRM188R71H104KA93D	0603	CAP CER 0.1uF, 50V,X7R,10%
C26	1	MURATA CORP.	GRM188R71H222KA01D	0603	CAP CER 2200pF,50V,X7R,10%

XRP7720/7724/7725EVB-DEMO-1

Quad Channel Digital PWM/PFM Demo Board Programmable Power Management System

Ref.	Qty	Manufacturer	Part Number	Size	Component
C38**	1	MURATA CORP.	GRM21BR71C225KA12L	0805	CAP CER 2.2uF, 16V,X7R,10%
R16,R17	2	PANASONIC	ERJ-3EKF4701V	0603	RES 4.7K OHM, 1/10W, 1%, SMD
J1	1	WURTH ELEKTRONIK	61300624321	2.54mm Angled Dual Socket	2.54mm dual Pin Socket Header WR- PHD
J3	1	WURTH ELEKTRONIK	613 010 243 121	2.54mm Angled Dual Socket	2.54mm dual Pin Socket Header WR- PHD
JP1	1	WURTH ELEKTRONIK	61300311121	2.54mm Pin Header	2.54mm Pin Header WR-PHD, 3 Pins
JP1(jumper)	1	WURTH ELEKTRONIK	609 002 115 121	2.54mm Pin Jumper	2.54mm Pin Jumper w/Test Point
P1, P2,P3,P4,P10	5	WURTH ELEKTRONIK	691 216 510 002	9.5x5.08mm	CONN.TERM. BLOCK 2POS
P5	1	WURTH ELEKTRONIK	61300621021	2.54mm Dual Pin Header	2.54mm Dual Pin Header Wr-PHD
P7	1	WURTH ELEKTRONIK	61301021021	2.54mm Dual Pin Header	2.54mm Dual Pin Header Wr-PHD
P9	1	WURTH ELEKTRONIK	61301511121	2.54mm Pin Header	2.54mm Pin Header WR-PHD, 15 Pins
P11	1	Switchcraft Corp.	RAPC722X	2.1mmID, 5.5mmOD	Conn. Powerjack Mini R/A, T/H
T6,T8,T10,T11	4	WURTH ELEKTRONIK	61304011121	2.54mm Pin Header	2.54mm Pin Header WR-PHD, 40 Pins

Note:** Not loaded on XRP7720EVB-DEMO-1

EVALUATION BOARD LAYOUT

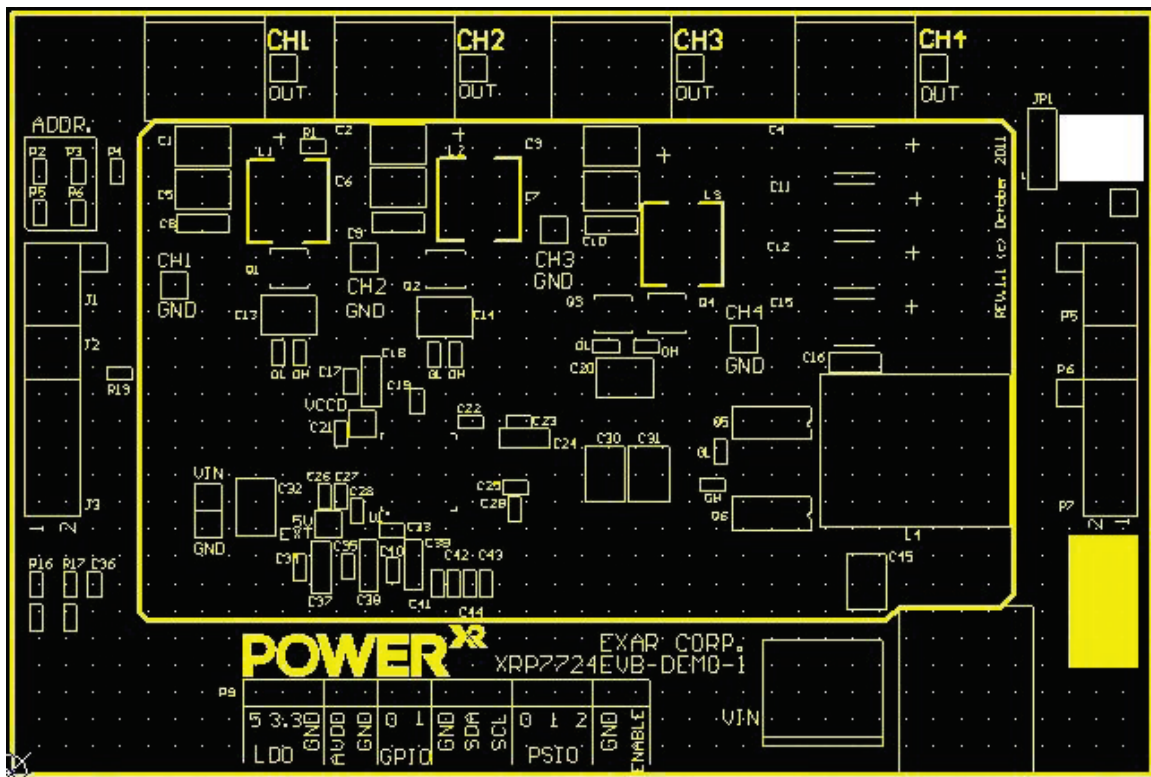

Figure 4: Component Placement – Top Side

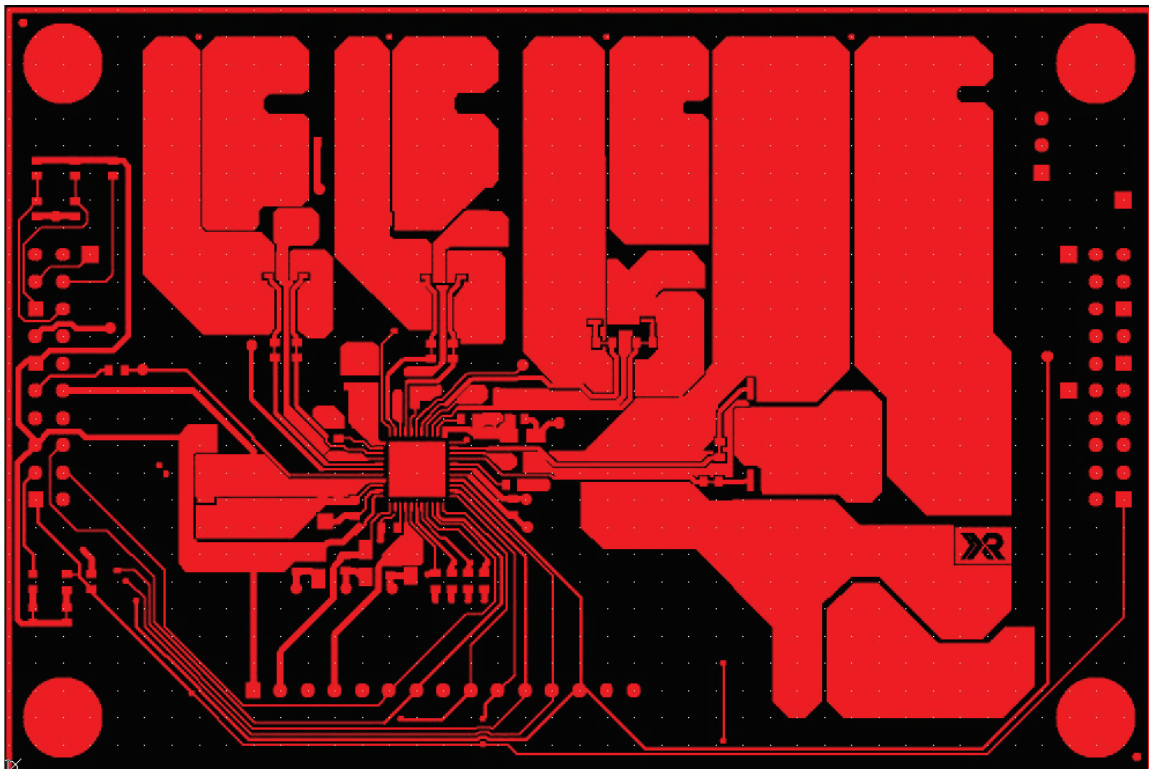

Figure 5: Layout – Top Side

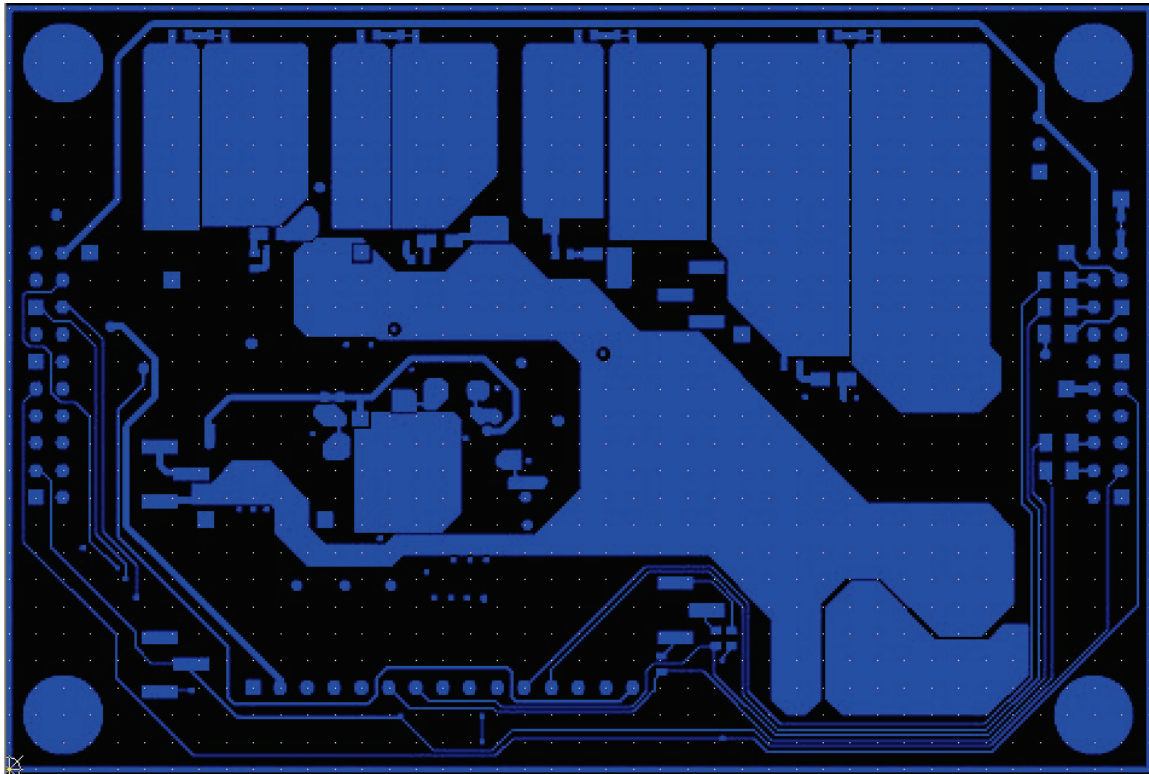

Figure 6: Layout - Bottom

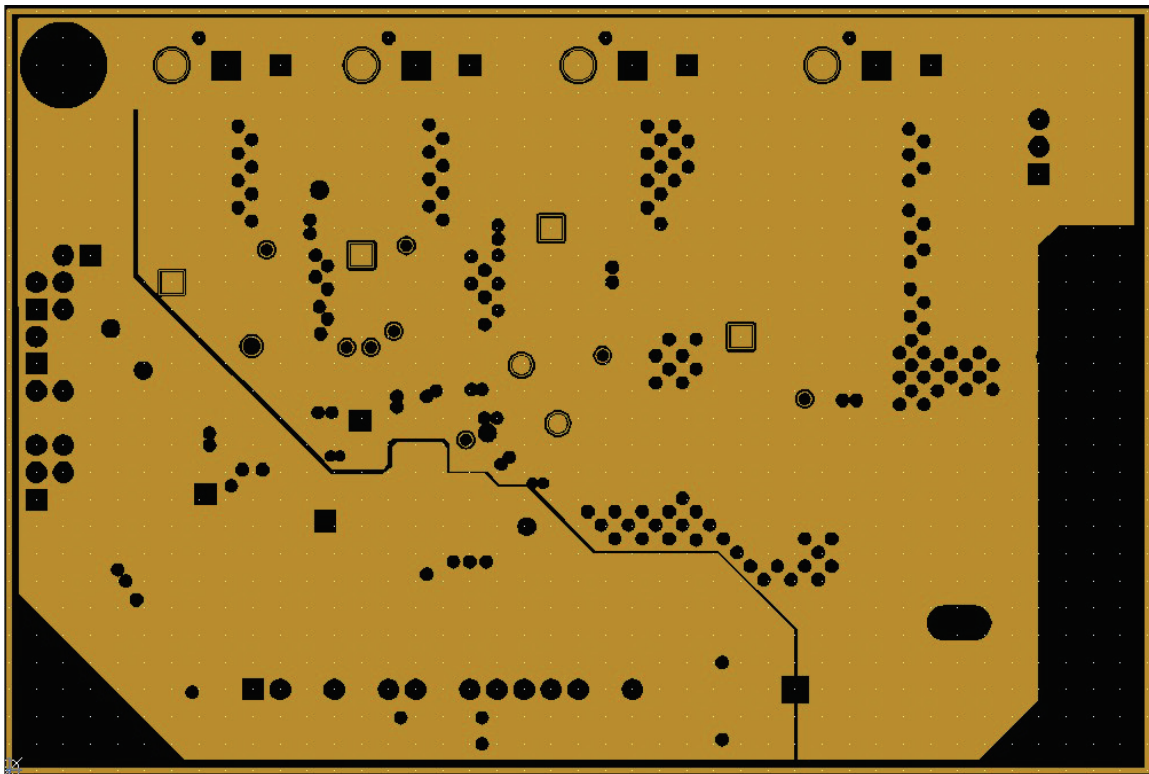

Figure 7: Layout - Middle Layer 1

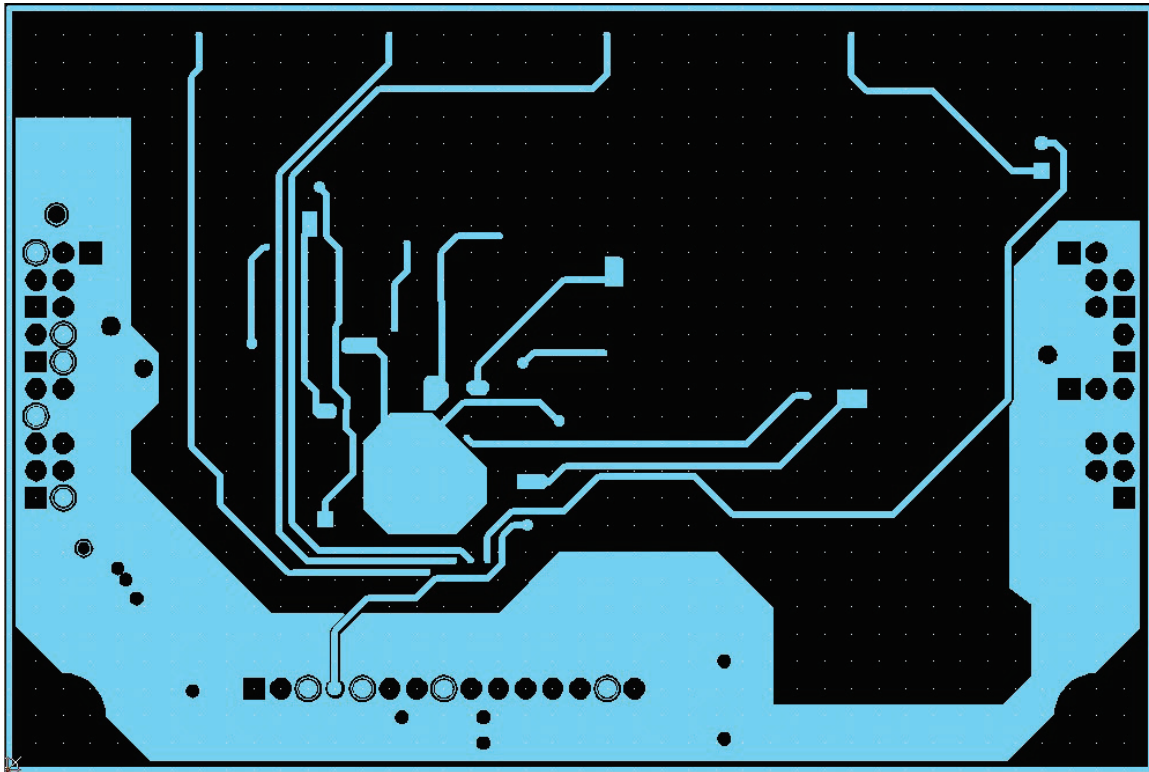

Figure 8: Layout – Internal Plane



XRP7720/7724/7725EVB-DEMO-1

Quad Channel Digital PWM/PFM Demo Board Programmable Power Management System

DOCUMENT REVISION HISTORY

Revision	Date	Description
1.0.0	09/28/12	Initial release of document
1.1.0	06/18/2013	BOM- Change of Manufacturer P1,P2,P3,P4,P10.
1.1.1	10/14/2013	Deleted C36 from the bill of materials
2.0.0	01/31/2014	Added XRP7720-DEV and XRP7725 information

BOARD REVISION HISTORY

Board Revision	Date	Description
XRP7724EVB- DEMO-1-01	10/01/12	Initial release of evaluation board

FOR FURTHER ASSISTANCE

Email:

customersupport@exar.com

Exar Technical Documentation:

<http://www.exar.com/TechDoc/default.aspx?>



EXAR CORPORATION

HEADQUARTERS AND SALES OFFICES

48720 Kato Road

Fremont, CA 94538 – USA

Tel.: +1 (510) 668-7000

Fax: +1 (510) 668-7030

www.exar.com

NOTICE

EXAR Corporation reserves the right to make changes to the products contained in this publication in order to improve design, performance or reliability. EXAR Corporation assumes no responsibility for the use of any circuits described herein, conveys no license under any patent or other right, and makes no representation that the circuits are free of patent infringement. Charts and schedules contained here in are only for illustration purposes and may vary depending upon a user's specific application. While the information in this publication has been carefully checked; no responsibility, however, is assumed for inaccuracies.

EXAR Corporation does not recommend the use of any of its products in life support applications where the failure or malfunction of the product can reasonably be expected to cause failure of the life support system or to significantly affect its safety or effectiveness. Products are not authorized for use in such applications unless EXAR Corporation receives, in writing, assurances to its satisfaction that: (a) the risk of injury or damage has been minimized; (b) the user assumes all such risks; (c) potential liability of EXAR Corporation is adequately protected under the circumstances.

Reproduction, in part or whole, without the prior written consent of EXAR Corporation is prohibited.