

# TPS54531 Step-Down Converter Evaluation Module User's Guide



## ABSTRACT

This user's guide contains information for the TPS54531EVM-530 evaluation module as well as for the TPS54531. Included are the performance specifications, schematic, and the bill of materials of the TPS54531EVM-530.

## Table of Contents

<b>1 Introduction</b> .....	3
<b>2 Performance Specification Summary</b> .....	3
<b>3 Modifications</b> .....	4
3.1 Output Voltage Setpoint.....	4
3.2 Output Filter and Closed-Loop Response.....	4
<b>4 Test Setup and Results</b> .....	4
4.1 Input/Output Connections.....	4
4.2 Efficiency.....	5
4.3 Load Regulation.....	6
4.4 Line Regulation.....	6
4.5 Loop Response.....	7
4.6 Load Transient Response.....	7
4.7 Output Voltage Ripple.....	8
4.8 Input Voltage Ripple.....	9
4.9 Start-Up.....	10
4.10 Shutdown.....	11
<b>5 Board Layout</b> .....	12
5.1 Layout.....	12
<b>6 Schematic, Bill of Materials, and Reference</b> .....	15
6.1 Schematic.....	15
6.2 Bill of Materials.....	16
6.3 Reference.....	16

## List of Figures

Figure 4-1. TPS54531EVM-530 Efficiency.....	5
Figure 4-2. TPS54531EVM-530 Light-Load Efficiency.....	5
Figure 4-3. TPS54531EVM-530 Load Regulation, $V_{IN} = 12\text{ V}$ and $V_{IN} = 24\text{ V}$ .....	6
Figure 4-4. TPS54531EVM-530 Line Regulation.....	6
Figure 4-5. TPS54531EVM-530 Closed Loop Response.....	7
Figure 4-6. TPS54531EVM-530 Load Transient Response.....	7
Figure 4-7. TPS54531EVM-530 Output Voltage Ripple ( $I_{OUT} = 5\text{ A}$ ).....	8
Figure 4-8. TPS54531EVM-530 Output Voltage Ripple ( $I_{OUT} = 1\text{ A}$ ).....	8
Figure 4-9. TPS54531EVM-530 Output Voltage Ripple ( $I_{OUT} = 0\text{ A}$ ).....	9
Figure 4-10. TPS54531EVM-530 Input Voltage Ripple.....	9
Figure 4-11. TPS54531EVM-530 Start-Up Relative to $V_{IN}$ with SS.....	10
Figure 4-12. TPS54531EVM-530 Start-Up Relative to EN with SS.....	10
Figure 4-13. TPS54531EVM-530 Shutdown Relative to $V_{IN}$ with SS.....	11
Figure 4-14. TPS54531EVM-530 Shutdown Relative to EN with SS.....	11
Figure 5-1. Top Assembly.....	12
Figure 5-2. Top Layer.....	13
Figure 5-3. Internal Layer 1.....	13
Figure 5-4. Internal Layer 2.....	14

Figure 5-5. Bottom Layer.....	14
Figure 6-1. TPS54531EVM-530 Schematic Diagram.....	15

### List of Tables

Table 1-1. Input Voltage and Output Current Summary.....	3
Table 2-1. TPS54531EVM-530 Performance Specifications Summary.....	3
Table 4-1. Connection and Test Points.....	4
Table 6-1. Bill of Materials.....	16

### Trademarks

Eco Mode™ is a trademark of Texas Instruments.

All trademarks are the property of their respective owners.

## 1 Introduction

The TPS54531 DC/DC converter is designed to provide up to a 5-A output from an input voltage source of 3.5 V to 28 V. Rated input voltage and output current range for the evaluation module are given in [Table 1-1](#).

The TPS54531EVM-530 evaluation module circuit is a single, non-synchronous buck converter providing 5 V at 5 A from an 8-V to 28-V input. The switching frequency is internally set at a nominal 570 kHz. The high-side MOSFET is incorporated inside the TPS54531 package along with the gate-drive circuitry. The low drain-to-source on resistance of the MOSFET allows the TPS54531 to achieve high efficiencies and helps keep the junction temperature low at high output currents. The compensation components are external to the integrated circuit (IC), and an external divider allows for an adjustable output voltage. Additionally, the TPS54531 provides adjustable slow start and undervoltage lockout inputs. The absolute maximum input voltage is 30 V for the TPS54531EVM-530. This user's guide describes the TPS54531EVM-530 performance.

**Table 1-1. Input Voltage and Output Current Summary**

EVM	INPUT VOLTAGE RANGE	OUTPUT CURRENT RANGE
TPS54531EVM-530	$V_{IN} = 8\text{ V to }28\text{ V}$	0 A to 5 A

## 2 Performance Specification Summary

A summary of the TPS54531EVM-530 performance specifications is provided in [Table 2-1](#). Specifications are given for an input voltage of  $V_{IN} = 12\text{ V}$  and an output voltage of 1.05 V, unless otherwise noted. The ambient temperature is 25°C for all measurement, unless otherwise noted.

**Table 2-1. TPS54531EVM-530 Performance Specifications Summary**

SPECIFICATIONS	TEST CONDITIONS	MIN	TYP	MAX	UNIT
Input voltage range ( $V_{IN}$ )		8	12	28	V
Output voltage			5		V
Operating frequency			570		kHz
Output current range		0		5	A
Line regulation	$I_O = 2.5\text{ A}$		$\pm 0.06$		%
Load regulation	$V_{IN} = 12\text{ V}$		$\pm 0.1$		%
Overcurrent limit	$V_{IN} = 12\text{ V}$ ,	5.5	8.5		A
Output ripple voltage	$V_{IN} = 12\text{ V}$ , $I_O = 5\text{ A}$		15		mV <sub>PP</sub>
Maximum efficiency	$V_{IN} = 8\text{ V}$ , $I_O = 0.7\text{ A}$		95.3		%

### 3 Modifications

These evaluation modules are designed to provide access to the features of the TPS54531. Some modifications can be made to this module.

#### 3.1 Output Voltage Setpoint

To change the output voltage of the EVMs, it is necessary to change the value of resistor R6. The value of R6 for a specific output voltage above 0.8 V can be calculated using [Equation 1](#).

$$R6 = \frac{R5 \times 0.8V}{V_{OUT} - 0.8V} \quad (1)$$

#### 3.2 Output Filter and Closed-Loop Response

The TPS54531 relies on the output filter characteristics and the compensation network of R3, C6, and C7 to ensure stability of the control loop. Pads for a feed forward capacitor (C11) are also included for increased flexibility.

### 4 Test Setup and Results

This section describes how to properly connect, set up, and use the TPS54531EVM-530. The section also includes test results typical for the evaluation modules and efficiency, output load regulation, output line regulation, load transient response, output voltage ripple, input voltage ripple, start-up, and switching frequency.

#### 4.1 Input/Output Connections

The TPS54531EVM-530 is provided with input and output connectors and test points as shown in [Table 4-1](#). A power supply capable of supplying 4 A must be connected to J1 through a pair of 20-AWG wires. The load must be connected to J2 through a pair of 20-AWG wires. The maximum load current capability is 5 A. Wire lengths must be minimized to reduce losses in the wires. Test point TP1 provides a place to monitor the  $V_{IN}$  input voltages with TP2 providing a convenient ground reference. TP7 is used to monitor the output voltage with TP8 as the ground reference.

**Table 4-1. Connection and Test Points**

REFERENCE DESIGNATOR	FUNCTION
J1	$V_{IN}$ (see <a href="#">Table 1-1</a> for $V_{IN}$ range)
J2	$V_{OUT}$ , 5 V at 5-A maximum
JP1	EN control. Jumper JP1-1 (EN) to JP1-2 (GND) to disable, remove jumper to enable
TP1	$V_{IN}$ test point at $V_{IN}$ connector
TP2	GND test point at $V_{IN}$ connector
TP3	EN test point
TP4	SS test point
TP5	Switch node test point
TP6	Loop response measurement test point
TP7	Output voltage test point at $V_{OUT}$ connector
TP8	Ground test point at $V_{OUT}$ connector

## 4.2 Efficiency

Figure 4-1 shows the efficiency for the TPS54531EVM-530 at an ambient temperature of 25°C.

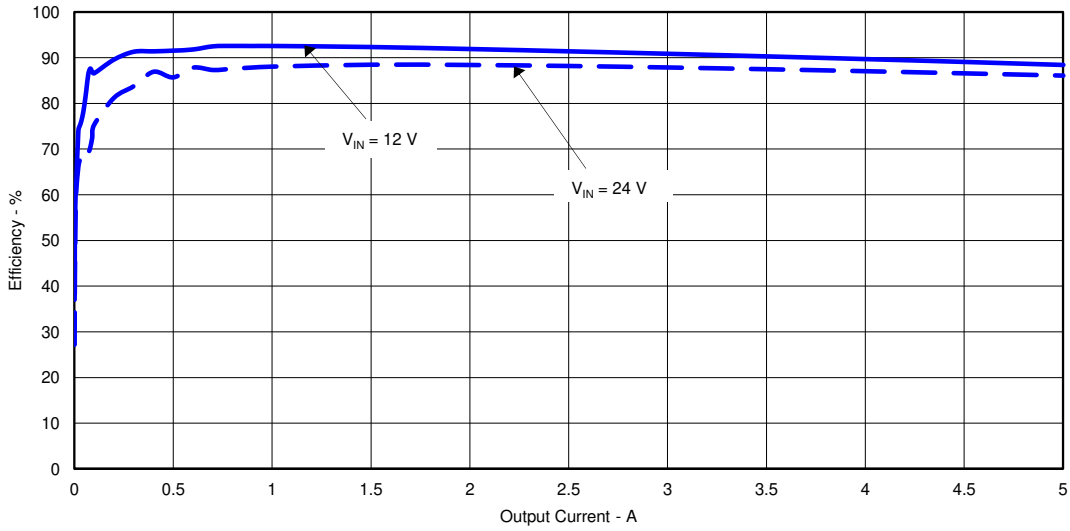

**Figure 4-1. TPS54531EVM-530 Efficiency**

Figure 4-2 shows the efficiency at light loads for the TPS54531EVM-530 at an ambient temperature of 25°C.

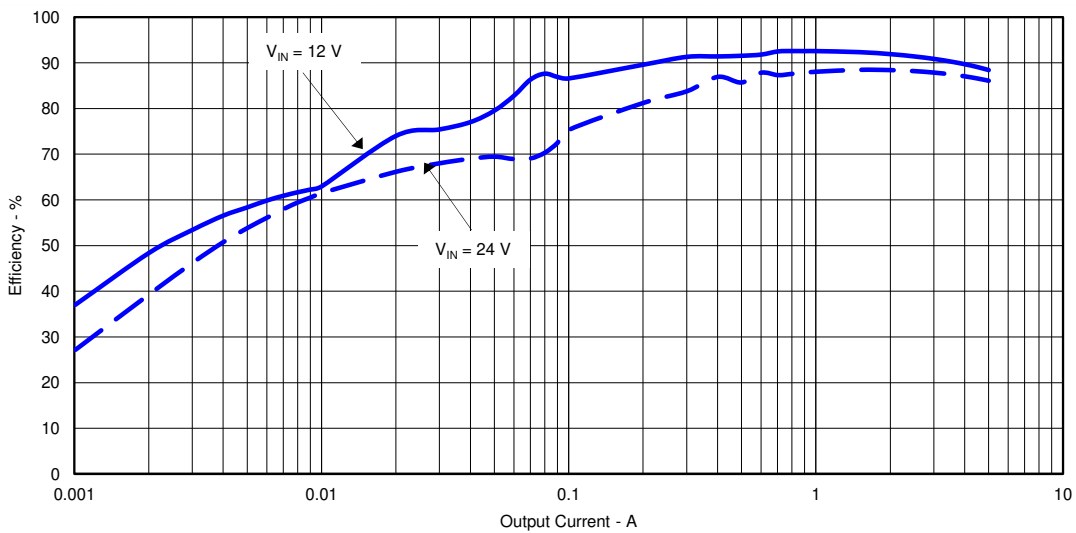

**Figure 4-2. TPS54531EVM-530 Light-Load Efficiency**

### 4.3 Load Regulation

The load regulation for the TPS54531EVM-530 is shown in Figure 4-3.

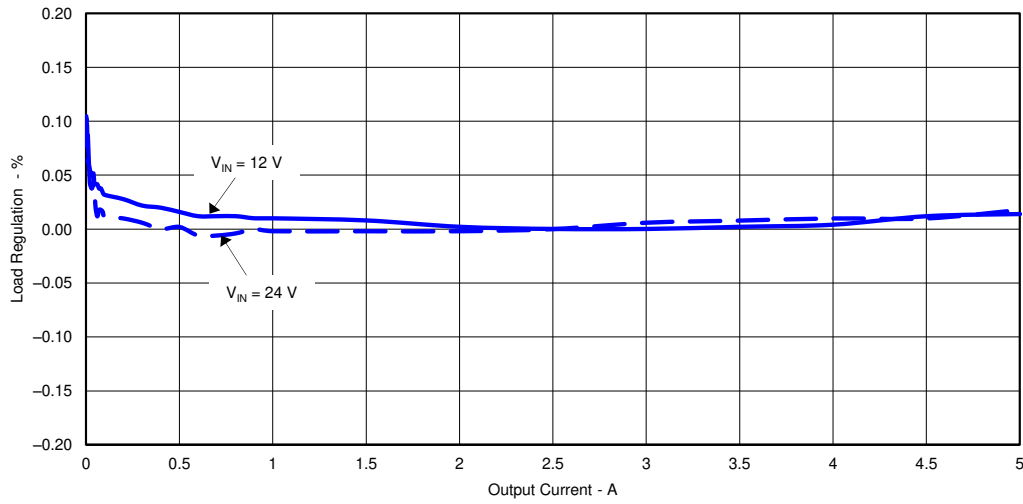

Figure 4-3. TPS54531EVM-530 Load Regulation,  $V_{IN} = 12\text{ V}$  and  $V_{IN} = 24\text{ V}$

### 4.4 Line Regulation

The line regulation for the TPS54531EVM-530 is shown in Figure 4-4.

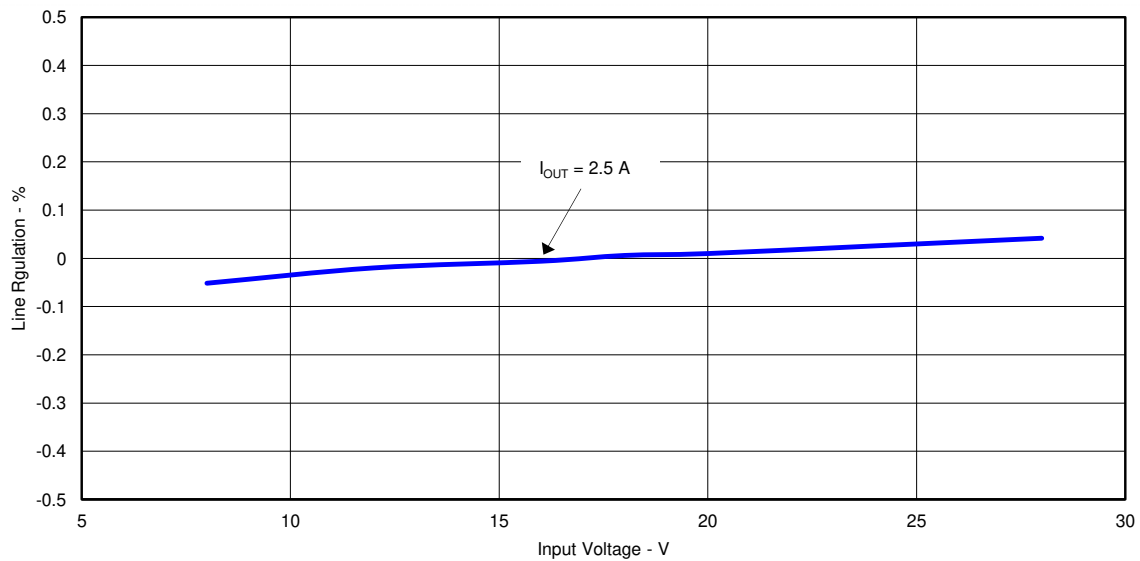
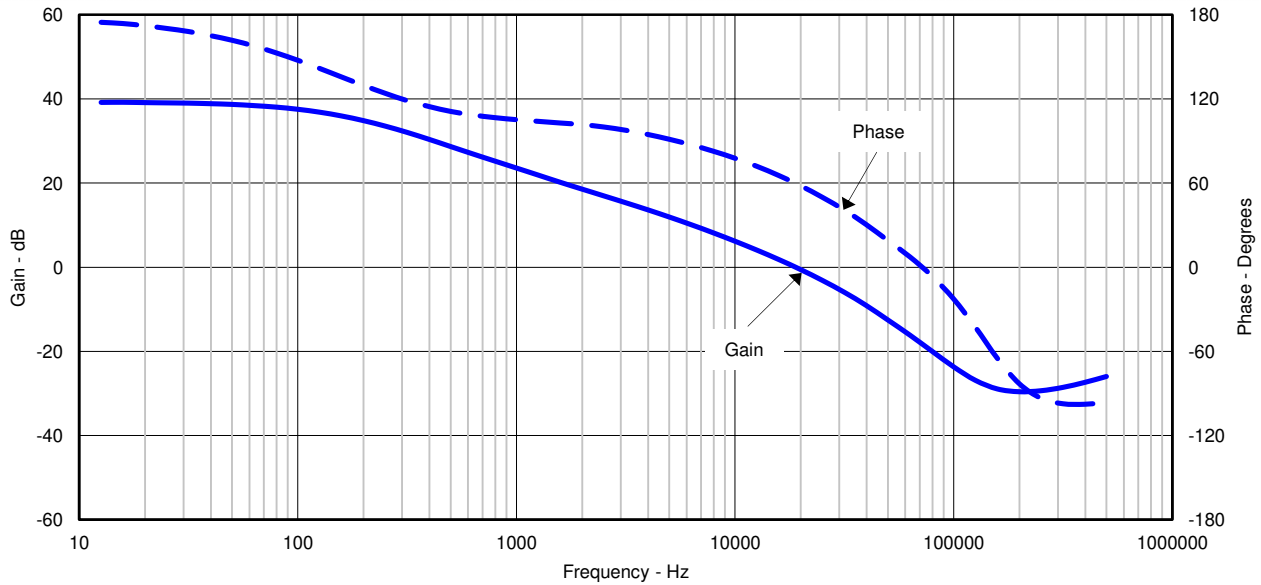

Figure 4-4. TPS54531EVM-530 Line Regulation

### 4.5 Loop Response

The TPS54531EVM-530 closed loop response is shown in Figure 4-5. Input voltage is 12 V and output current is 2.5 A.



**Figure 4-5. TPS54531EVM-530 Closed Loop Response**

### 4.6 Load Transient Response

The TPS54531EVM-530 response to load transient is shown in Figure 4-6. The current step is from 1.25 A to 3.75 A. Total peak-to-peak voltage variation is as shown.

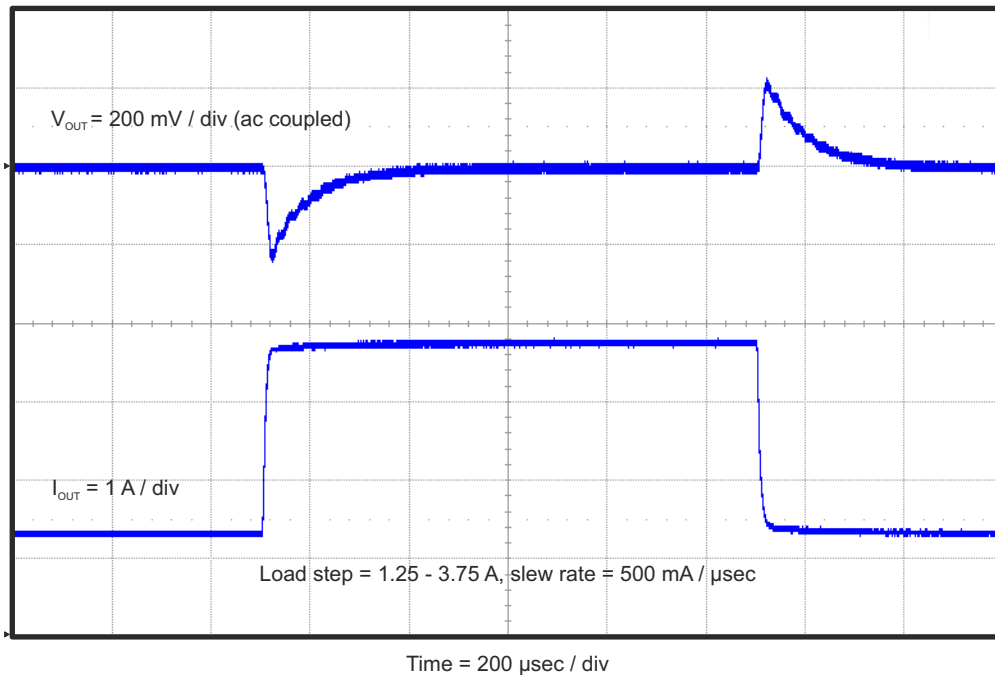

**Figure 4-6. TPS54531EVM-530 Load Transient Response**

### 4.7 Output Voltage Ripple

The TPS54531EVM-530 output voltage ripple is shown in Figure 4-7. The output current is the rated full load of 5 A.

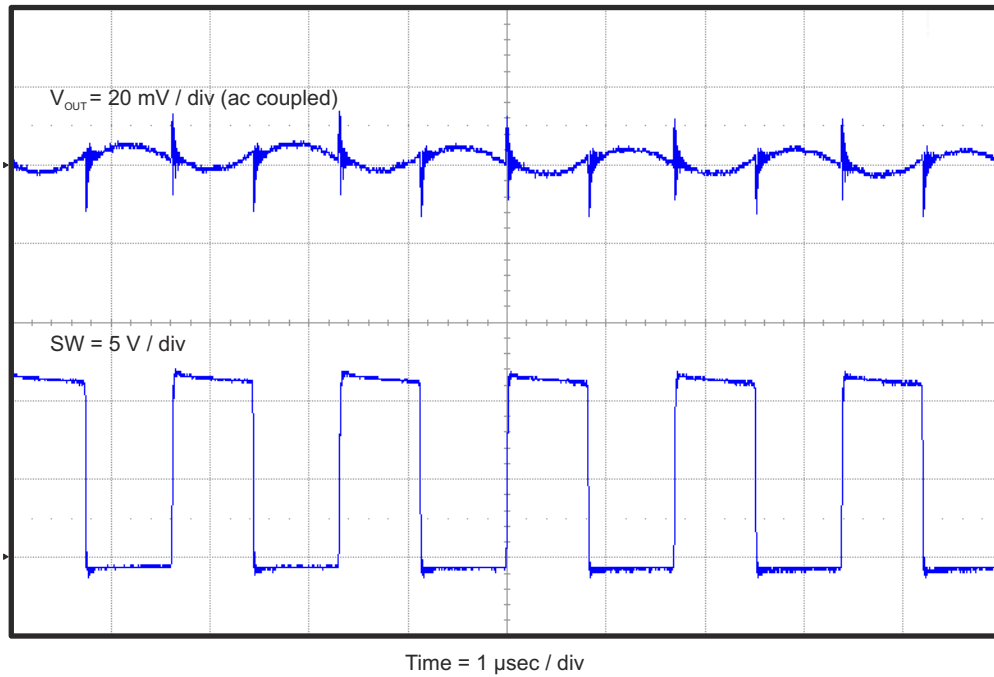

**Figure 4-7. TPS54531EVM-530 Output Voltage Ripple ( $I_{OUT} = 5 \text{ A}$ )**

The TPS54531EVM-530 output voltage ripple is shown in Figure 4-8. The output current is 1 A.

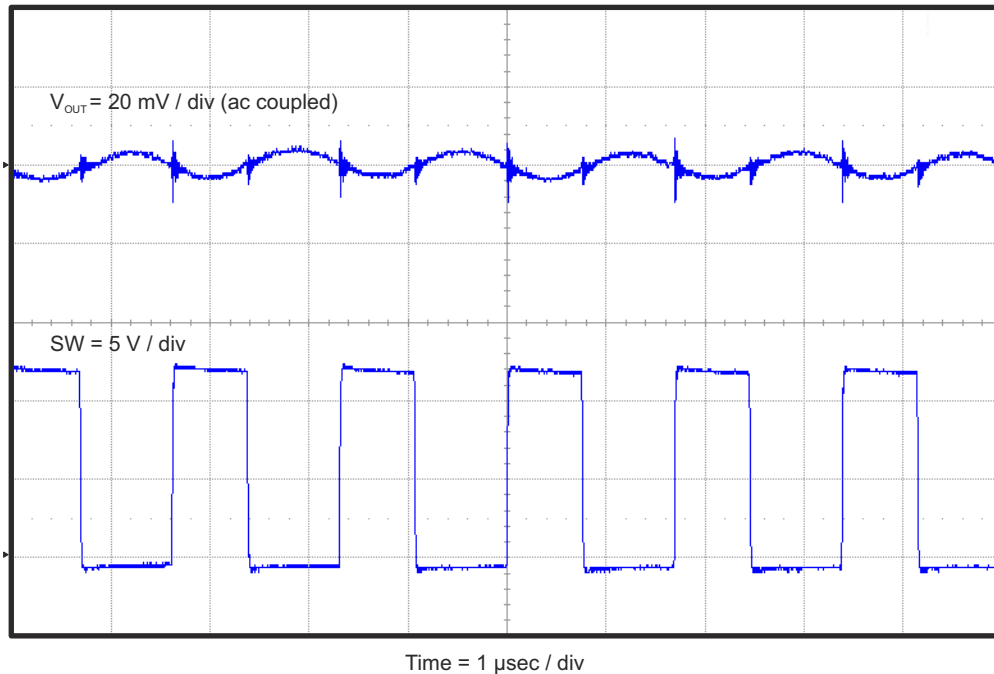

**Figure 4-8. TPS54531EVM-530 Output Voltage Ripple ( $I_{OUT} = 1 \text{ A}$ )**



The TPS54531EVM-530 output voltage ripple is shown in [Figure 4-9](#). The output current is 0 A (no load).

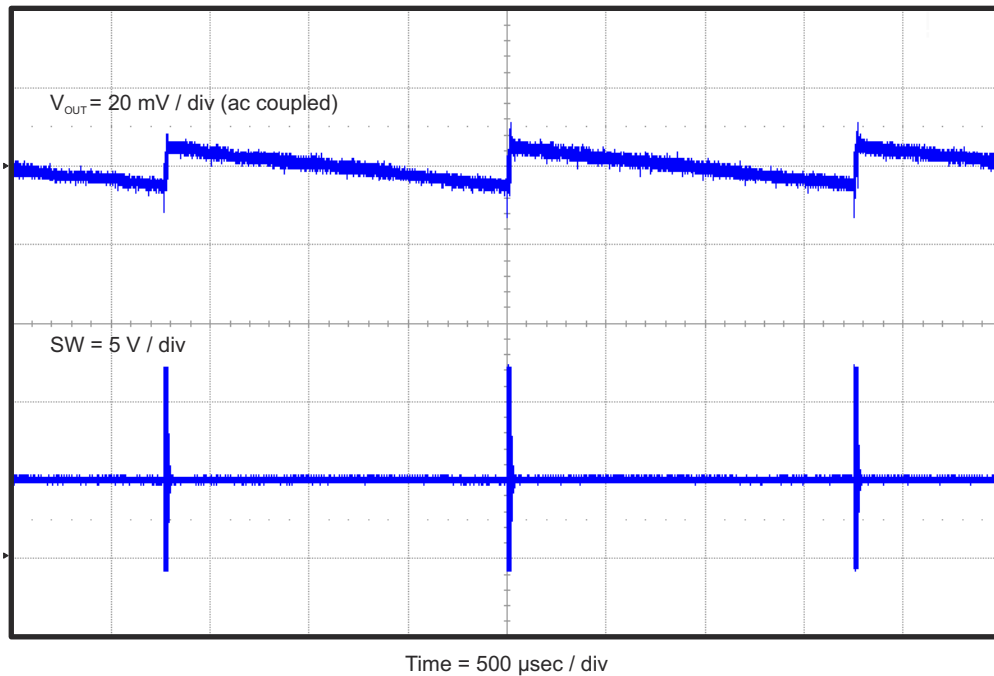

**Figure 4-9. TPS54531EVM-530 Output Voltage Ripple ( $I_{OUT} = 0 \text{ A}$ )**

#### 4.8 Input Voltage Ripple

The TPS54531EVM-530 input voltage ripple is shown in [Figure 4-10](#). The output current is the rated full load of 5 A.

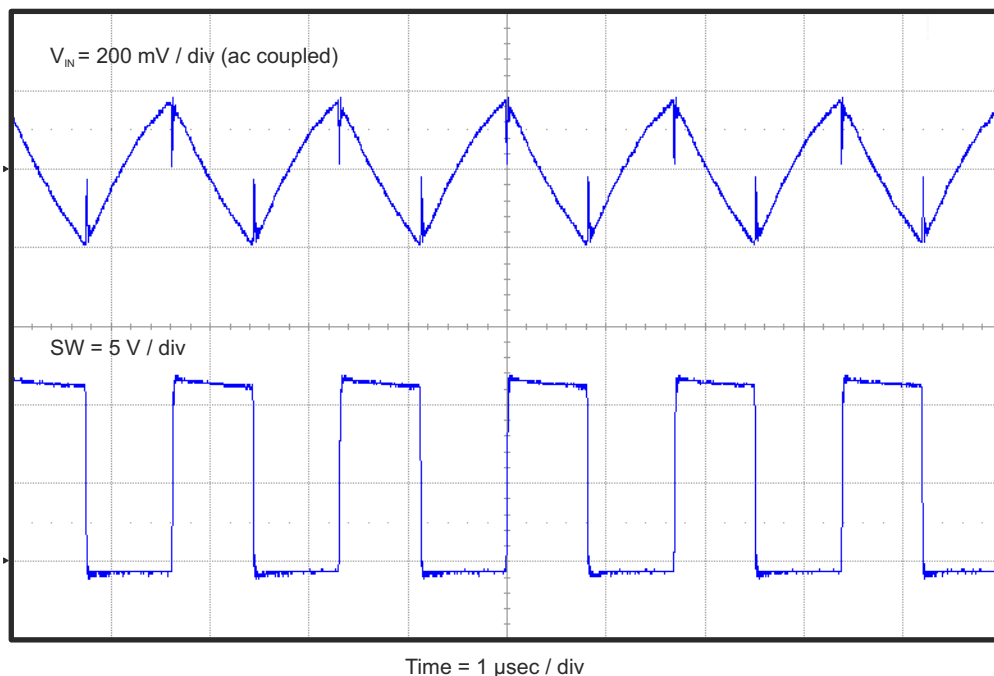

**Figure 4-10. TPS54531EVM-530 Input Voltage Ripple**

### 4.9 Start-Up

The TPS54531EVM-530 start-up waveforms relative to  $V_{IN}$  and EN are shown in Figure 4-11 and Figure 4-12.  $R_{LOAD} = 5 \Omega$

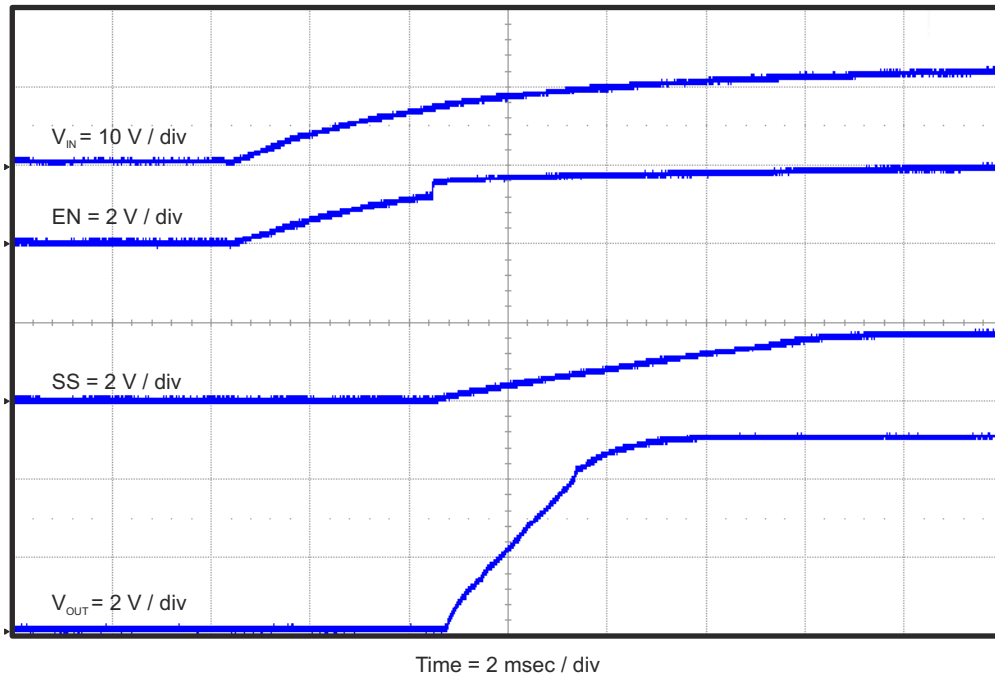

**Figure 4-11. TPS54531EVM-530 Start-Up Relative to  $V_{IN}$  with SS**

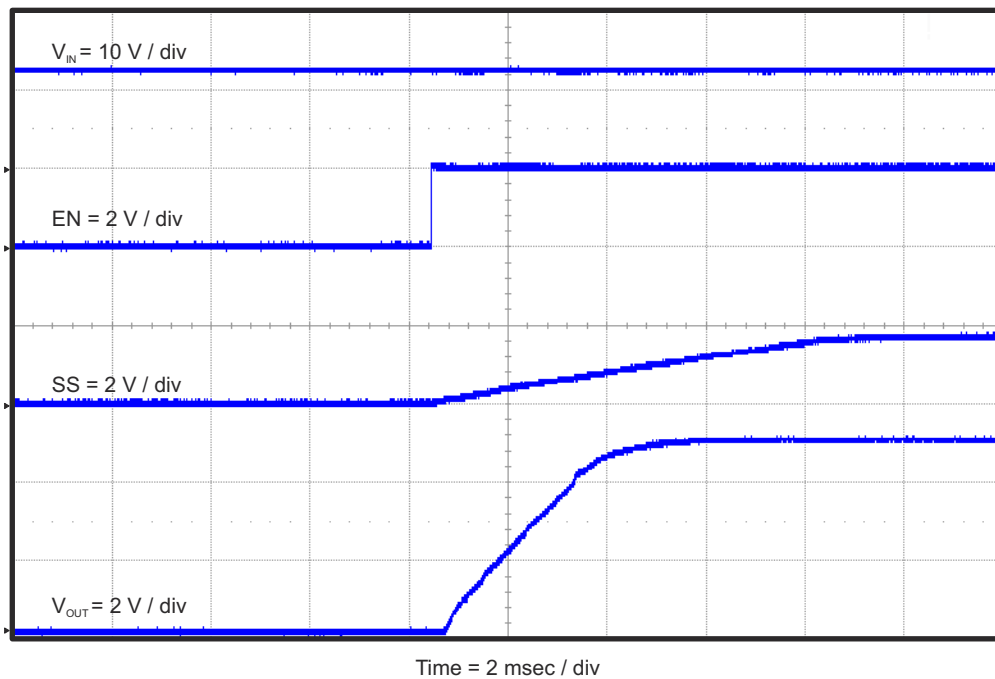

**Figure 4-12. TPS54531EVM-530 Start-Up Relative to EN with SS**

### 4.10 Shutdown

The TPS54531EVM-530 shutdown waveforms relative to  $V_{IN}$  and EN are shown in Figure 4-13 and Figure 4-14.  $R_{LOAD} = 5 \Omega$

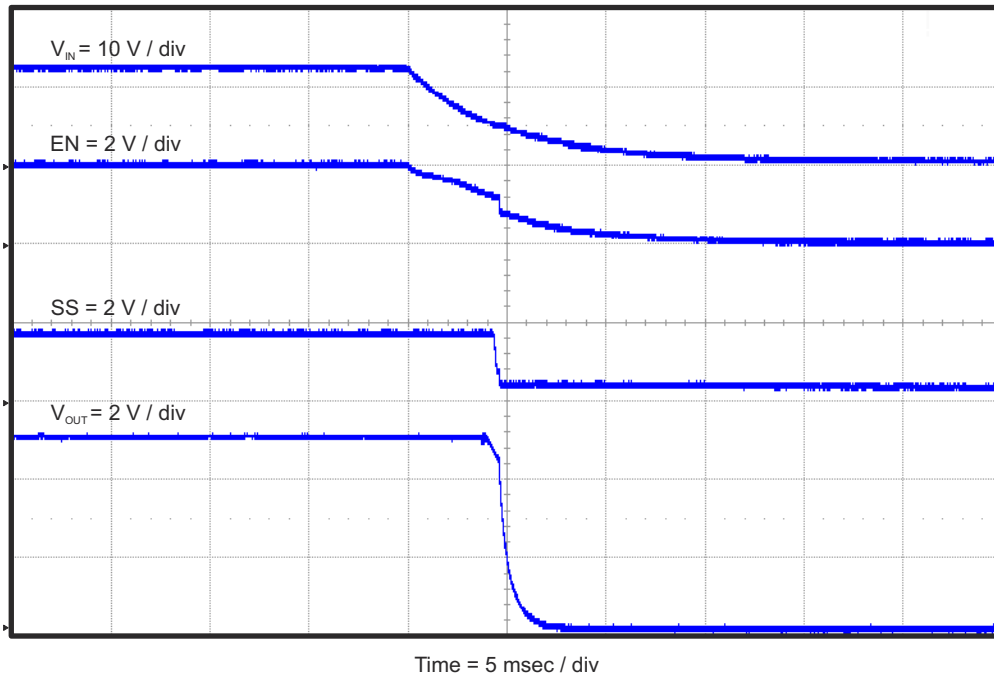

**Figure 4-13. TPS54531EVM-530 Shutdown Relative to  $V_{IN}$  with SS**

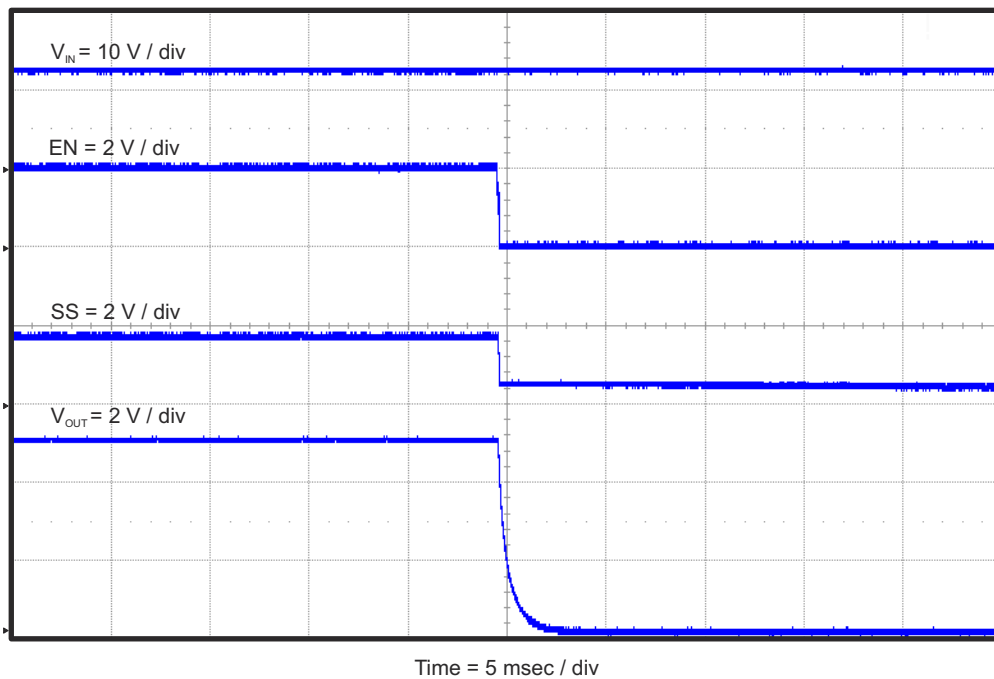

**Figure 4-14. TPS54531EVM-530 Shutdown Relative to EN with SS**

## 5 Board Layout

This section provides description of the TPS54531EVM-530, board layout, and layer illustrations.

### 5.1 Layout

The board layout for the TPS54531EVM-530 is shown in [Figure 5-1](#) through [Figure 5-5](#). The top layer contains the main power traces for VIN, VOUT, and ground. Also on the top layer are connections for the pins of the TPS54531. Most of the signal traces also are located on the top side. The input decoupling capacitors (C1, C2, and C3) are located as close to the IC as possible. The input and output connectors, test points, and all of the components are located on the top side. An analog ground area is provided on the top side to terminate the sensitive compensation components (C7 and R3) and the output voltage feed back divider (R6). This ground area and the main power ground (GND) are connected at a single point on the top layer at the IC pin 7 (GND). The two internal layers are completely dedicated to power ground planes for heat dissipation. The bottom layer is primarily power ground with traces to connect the BOOT capacitor (C4) and the feedback trace from VOUT to the voltage set point divider network.

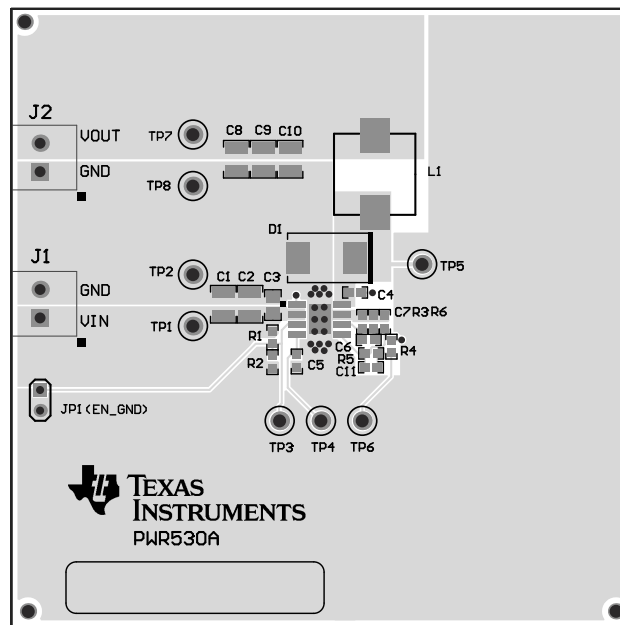

**Figure 5-1. Top Assembly**

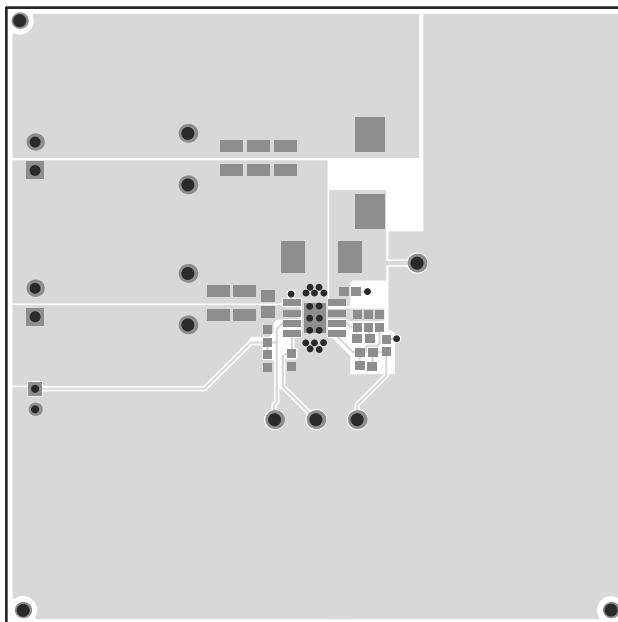

**Figure 5-2. Top Layer**

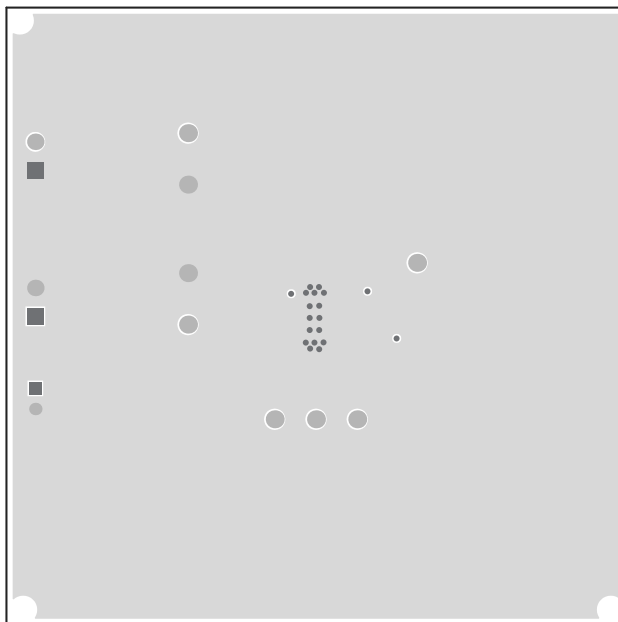

**Figure 5-3. Internal Layer 1**

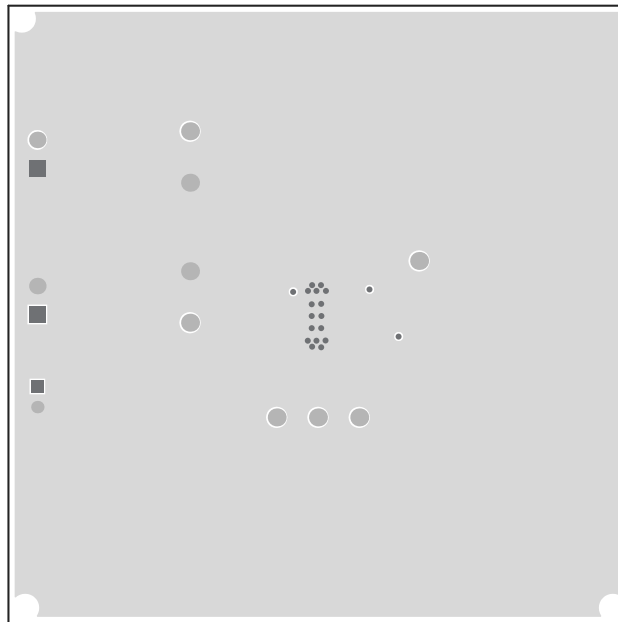

**Figure 5-4. Internal Layer 2**

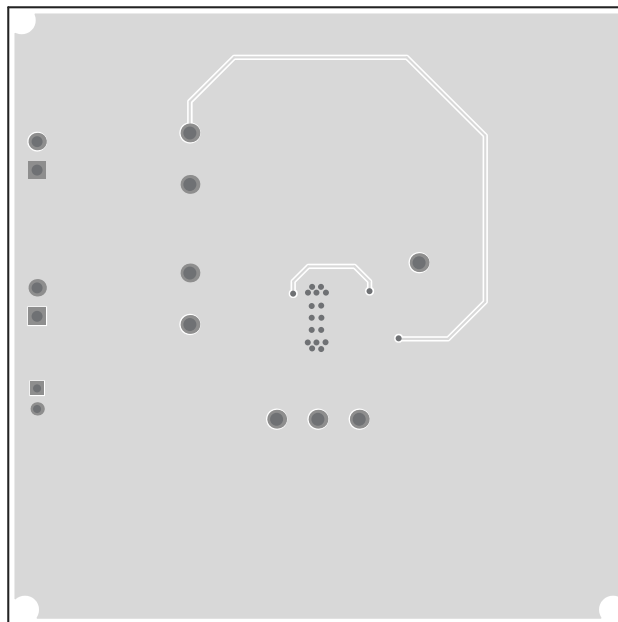
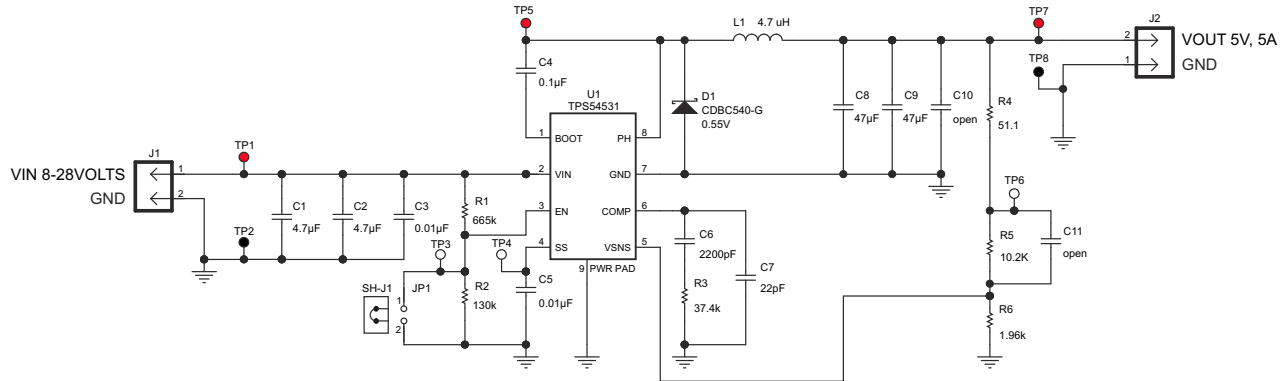

**Figure 5-5. Bottom Layer**

## 6 Schematic, Bill of Materials, and Reference

### 6.1 Schematic

Figure 6-1 is the schematic for the TPS54531EVM-530.



**Figure 6-1. TPS54531EVM-530 Schematic Diagram**

## 6.2 Bill of Materials

**Table 6-1. Bill of Materials**

DESIGNATOR	QTY	VALUE	DESCRIPTION	PACKAGE REFERENCE	PART NUMBER	MANUFACTURER
	1		Printed Circuit Board		PWR530A	Any
C1, C2	2	4.7 $\mu$ F	CAP, CERM, 4.7 $\mu$ F, 50 V, $\pm$ 10%, X7R, 1210	1210	GRM32ER71H475KA88L	MuRata
C3	1	0.01 $\mu$ F	CAP, CERM, 0.01 $\mu$ F, 50 V, $\pm$ 10%, X7R, 0805	0805	GRM216R71H103KA01D	MuRata
C4	1	0.1 $\mu$ F	CAP, CERM, 0.1 $\mu$ F, 25 V, $\pm$ 10%, X7R, 0603	0603	C1608X7R1E104K	TDK
C5	1	0.01 $\mu$ F	CAP, CERM, 0.01 $\mu$ F, 100 V, $\pm$ 10%, X7R, 0603	0603	06031C103KAT2A	AVX
C6	1	2200 pF	CAP, CERM, 2200 pF, 50 V, $\pm$ 10%, X7R, 0603	0603	GRM188R71H222KA01D	MuRata
C7	1	22 pF	CAP, CERM, 22 pF, 50 V, $\pm$ 5%, C0G/NP0, 0603	0603	GRM1885C1H220JA01D	MuRata
C8, C9	2	47 $\mu$ F	CAP, CERM, 47 $\mu$ F, 10 V, $\pm$ 10%, X5R, 1210	1210	GRM32ER61A476KE20L	MuRata
C10	0		CAP, CERM,	1210		
C11	0		CAP, CERM,	0603		
D1	1	0.55 V	Diode, Schottky, 4 0V, 5 A, SMC	SMC	CDBC540-G	Comchip Technology
J1, J2	2	ED555/2DS	Connector, Male 2 Pole 3.5 mm, 6 A, 150 V	6.5 $\times$ 6.5 mm	ED555/2DS	On Shore Tech
JP1	1	PEC02SAAN	Header, Male 2-pin, 100-mil spacing,	0.100 inch $\times$ 2	PEC02SAAN	Sullins
L1	1	4.7 $\mu$ H	Inductor, 7 A, 15 m $\Omega$	10mm $\times$ 10 mm	74437368047	Würth Elektronik
LBL1	1		Thermal Transfer Printable Labels, 1.250" W $\times$ 0.250" H - 10,000 per roll	PCB Label 1.25"H $\times$ 0.250"W	THT-13-457-10	Brady
R1	1	665 k	RES, 6650k $\Omega$ , 1%, 0.1W, 0603	0603	CRCW0603665KFKEA	Vishay-Dale
R2	1	130 k	RES, 130k $\Omega$ , 1%, 0.1 W, 0603	0603	CRCW060130KFKEA	Vishay-Dale
R3	1	37.4 k	RES, 37.4k $\Omega$ , 1%, 0.1 W, 0603	0603	CRCW060337K4FKEA	Vishay-Dale
R4	1	51.1	RES, 51.1 $\Omega$ , 1%, 0.1 W, 0603	0603	CRCW060351R1FKEA	Vishay-Dale
R5	1	10.2 K	RES, 10.2 $\Omega$ , 1%, 0.1 W, 0603	0603	CRCW060310R2FKEA	Vishay-Dale
R6	1	1.96 k	RES, 1.96 k $\Omega$ , 1%, 0.1 W, 0603	0603	CRCW06031K96FKEA	Vishay-Dale
SH-J1	1	1 $\times$ 2	Shunt, 100 mil, Gold plated, Black	Shunt	969102-0000-DA	3M
TP1, TP5, TP7	3	Red	Test Point, TH, Compact, Red	Keystone5005	5005	Keystone
TP2, TP8	2	Black	Test Point, TH, Compact, Black	Keystone5006	5006	Keystone
TP3, TP4, TP6	3	White	Test Point, TH, Compact, White	Keystone5007	5007	Keystone
U1	1		IC, DC-DC Converter, 4.5 – 28 V <sub>IN</sub> , 5 A	DDA-8	TPS54531DDA	Texas Instruments

## 6.3 Reference

*TPS54531, 5A, 28-V Input, Step-Down SWIFT™ Converter with Eco Mode™ Data Sheet*



## IMPORTANT NOTICE AND DISCLAIMER

TI PROVIDES TECHNICAL AND RELIABILITY DATA (INCLUDING DATA SHEETS), DESIGN RESOURCES (INCLUDING REFERENCE DESIGNS), APPLICATION OR OTHER DESIGN ADVICE, WEB TOOLS, SAFETY INFORMATION, AND OTHER RESOURCES "AS IS" AND WITH ALL FAULTS, AND DISCLAIMS ALL WARRANTIES, EXPRESS AND IMPLIED, INCLUDING WITHOUT LIMITATION ANY IMPLIED WARRANTIES OF MERCHANTABILITY, FITNESS FOR A PARTICULAR PURPOSE OR NON-INFRINGEMENT OF THIRD PARTY INTELLECTUAL PROPERTY RIGHTS.

These resources are intended for skilled developers designing with TI products. You are solely responsible for (1) selecting the appropriate TI products for your application, (2) designing, validating and testing your application, and (3) ensuring your application meets applicable standards, and any other safety, security, regulatory or other requirements.

These resources are subject to change without notice. TI grants you permission to use these resources only for development of an application that uses the TI products described in the resource. Other reproduction and display of these resources is prohibited. No license is granted to any other TI intellectual property right or to any third party intellectual property right. TI disclaims responsibility for, and you will fully indemnify TI and its representatives against, any claims, damages, costs, losses, and liabilities arising out of your use of these resources.

TI's products are provided subject to [TI's Terms of Sale](#) or other applicable terms available either on [ti.com](http://ti.com) or provided in conjunction with such TI products. TI's provision of these resources does not expand or otherwise alter TI's applicable warranties or warranty disclaimers for TI products.

TI objects to and rejects any additional or different terms you may have proposed.

Mailing Address: Texas Instruments, Post Office Box 655303, Dallas, Texas 75265  
Copyright © 2022, Texas Instruments Incorporated