



## 2S8W\_2RP Series

2W - Dual/Single Output - Wide Input - Isolated & Regulated DC-DC Converter

### DC-DC Converter

**2 Watt**

- ⊕ **Wide 2:1 Input Voltage Range**
- ⊕ **High Efficiency up to 85%**
- ⊕ **2W Single and Dual outputs**
- ⊕ **I/O Isolation 2KVDC and 4KVDC Option**
- ⊕ **Operating Temperature Range: -40°C to +100°C**
- ⊕ **Continuous Short Circuit Protection (SCP)**
- ⊕ **Remote ON/OFF Control**

The 2S8W\_2RP series are specially designed for applications where a wide range input voltage power supplies are isolated from the input power supply in a distributed power supply system on a circuit board.

These products apply to:

- 1) Where the voltage of the input power supply is wide range (voltage range  $\leq 2:1$ )
- 2) Where isolation is necessary between input and output (isolation voltage  $\leq 2000\text{VDC}/4000\text{VDC}$ )
- 3) Where the regulation of the output voltage and the output ripple noise are demanded



Common specifications	
Input filter:	Capacitor
Short circuit protection:	Continuous
Temperature rise at full load:	15°C TYP
Cooling:	Free air convection
Operation temperature range:	-40°C~+100°C
Operating case temperature:	110°C MAX
Storage temperature range:	-55°C ~+125°C
Storage humidity range:	< 95%
Lead temperature range:	300°C MAX, 1.5mm from case for 10 sec
No-load power consumption:	50mW TYP / 150mW MAX
Temperature coefficient:	-40°C to +85°C ambient 0.015 %/°C TYP
Operating Frequency:	150kHz MIN
Case material:	Non-conductive black plastic [UL94-V0]
Potting material:	Epoxy [UL94-V0]
MTBF (MIL-HDBK 217F):	+25°C: 2647x10 <sup>3</sup> hours +85°C: 457x10 <sup>3</sup> hours
Weight:	4.7g

Isolation specifications					
Item	Test condition	Min	Typ	Max	Units
Isolation voltage	Tested for 1 second	2000 and 4000			VDC
Isolation resistance	500VDC, input to output	15			GΩ
Isolation capacitance	100KHz		30		pF

Output specifications						
Item	Test condition	Min	Typ	Max	Units	
Output voltage accuracy	Nominal Vin and full load		±2		%	
Line regulation	Vin=min to max, full load		±0.5		%	
Load regulation	20% to 100% full load		±0.5		%	
Output Ripple & Noise	20MHz Bandwidth			60	mVp-p	
Remote Power OFF (leave open if not used) (15 VDC max.)	Device ON				open or <0.8 VDC	
	Device OFF (Stand by input current)				CTRL>1.5VDC 0.5mA max.	

#### Model selection:

**WCT\*\*\_xxyyN##O**

**W**=Watt; **C**= Case; **T**=Type; **\*\***= Voltage Variation (omitted  $\pm 10\%$ );

**xx**= Vin; **yy**= Vout; **N**= Numbers of Output; **##**= Isolation (kVDC);

**O**= output regulation

#### Example:

**2S8W\_0505S2RP**

**2**=2Watt; **S8**= SIP8; **W**=wide input (2:1); **4,5** - 9Vin; **5**Vout;

**S**= Single Output; **2**= 2000VDC; **R**= Regulated Output

**P**= Short Circuit Protection

#### Note:

1. All specifications measured at Ta=25°C, humidity<75%, nominal input voltage and rated output load unless otherwise specified.
2. In this datasheet, all the test methods of indications are based on corporate standards.

## 2S8W\_2RP Series

2W - Dual/Single Output - Wide Input - Isolated & Regulated  
DC-DC Converter

Part Number	Input Voltage [V]	Output Voltage [VDC]	Output Current [mA, max]	Efficiency [%, typ]	Max. Capacitive Load [ $\mu$ F]
2S8W_xx03SXR	4.5-9, 9-18, 18-36, 36-75	3.3	400	76-81	680
2S8W_xx05SXR	4.5-9, 9-18, 18-36, 36-75	5	400	77-82	680
2S8W_xx09SXR	4.5-9, 9-18, 18-36, 36-75	9	222	77-83	470
2S8W_xx12SXR	4.5-9, 9-18, 18-36, 36-75	12	167	80-85	330
2S8W_xx15SXR	4.5-9, 9-18, 18-36, 36-75	15	133	80-85	330
2S8W_xx03DXR	4.5-9, 9-18, 18-36, 36-75	$\pm$ 3.3	$\pm$ 200	76-81	$\pm$ 330
2S8W_xx05DXR	4.5-9, 9-18, 18-36, 36-75	$\pm$ 5	$\pm$ 200	77-82	$\pm$ 330
2S8W_xx09DXR	4.5-9, 9-18, 18-36, 36-75	$\pm$ 9	$\pm$ 111	81-85	$\pm$ 220
2S8W_xx12DXR	4.5-9, 9-18, 18-36, 36-75	$\pm$ 12	$\pm$ 83	81-85	$\pm$ 220
2S8W_xx15DXR	4.5-9, 9-18, 18-36, 36-75	$\pm$ 15	$\pm$ 66	81-85	$\pm$ 220

- X=2=2KVDC, X=4=4KVDC
- xx=Input Voltage (possible for other input and output voltage combinations on request)  
 Vin=4.5-9V, xx=05  
 Vin=9-18V, xx=12  
 Vin=18-36V, xx=24  
 Vin=36-75V, xx=48

## Functional block diagram

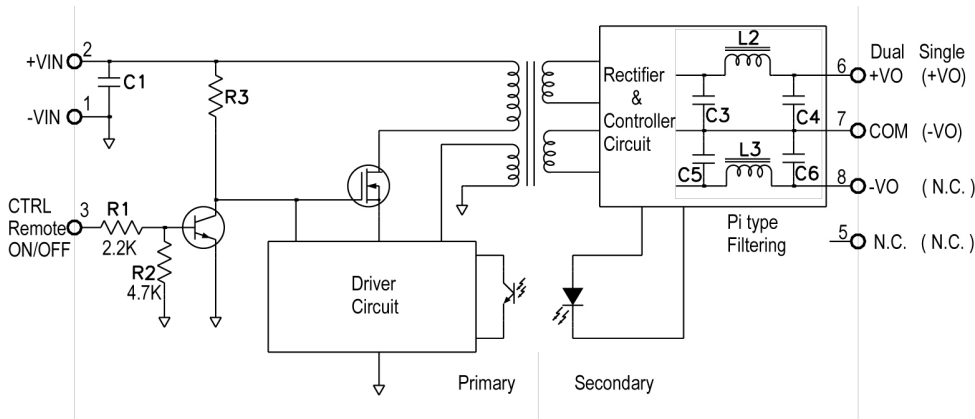

Input voltage	C1 values
4.5-18V	10 $\mu$ F/25V
18-36V	4.7 $\mu$ F/50V
36-75V	1 $\mu$ F/100V

## Mechanical dimensions and footprint

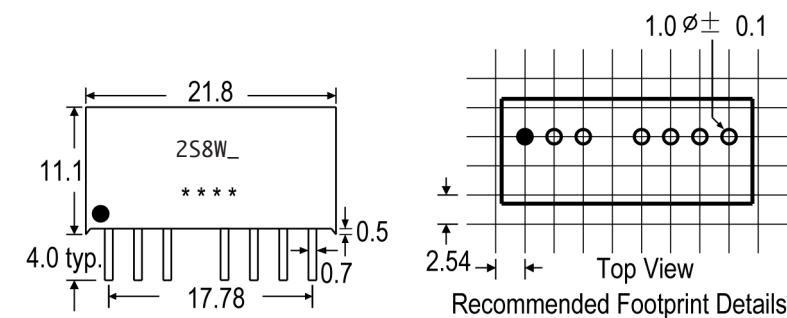

### Pin Connections

Pin#	Single	Dual
1	-Vin	-Vin
2	+Vin	+Vin
3	CTRL	CTRL
5	NC	NC
6	+Vout	+Vout
7	-Vout	COM
8	NC	-Vout

NC=No Connection

CTRL=Remote ON/OFF Control

## 2S8W\_2RP Series

2W - Dual/Single Output - Wide Input - Isolated & Regulated  
DC-DC Converter

### Typical characteristics

Derating graph (Natural convection)

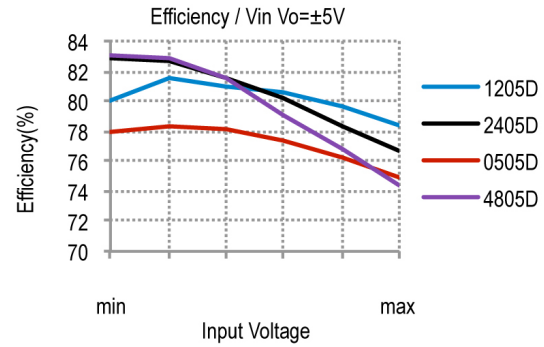
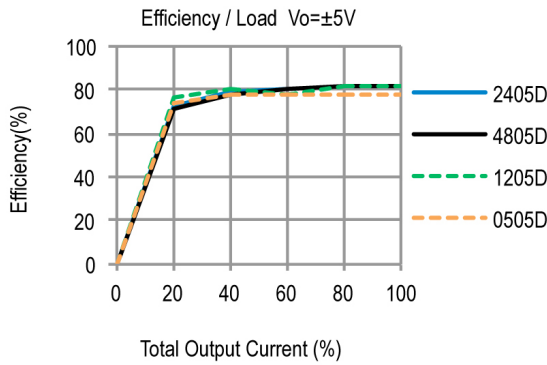
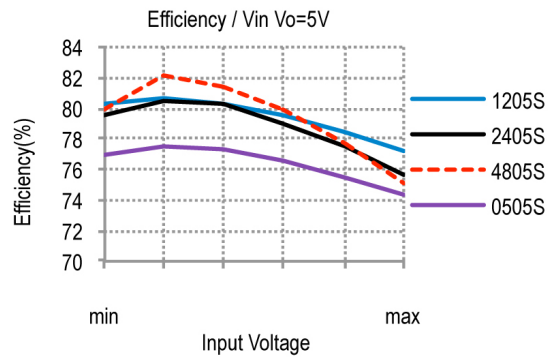
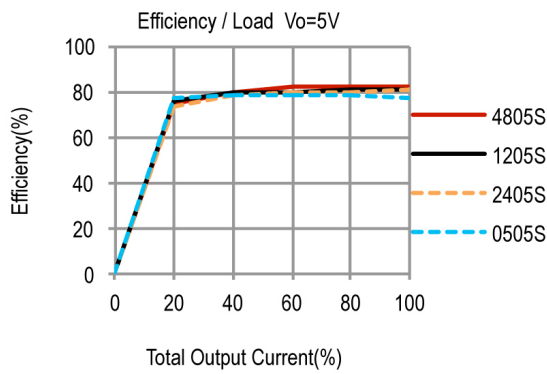
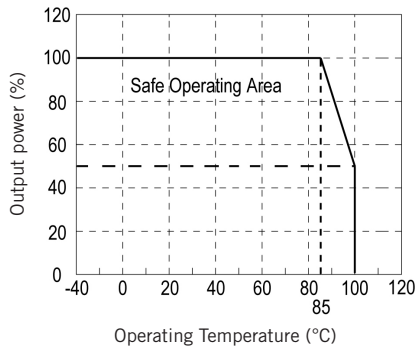

### Tube outline

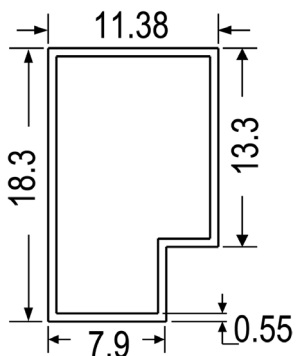

**Note:**  
Unit: mm[inch]  
General tolerances: ±0.50mm

L=520mm  
Tube quantity: 23pcs