

2 Way-0° 50Ω DC to 18 GHz

## The Big Deal

- Ultra-wide bandwidth, DC to 18 GHz
- High isolation, 20 dB typ. at 12 GHz
- Small size, 5 x 5 x 1 mm



CASE STYLE: DG1677-2

## Product Overview

Mini-Circuits' EP2RKU+ is a MMIC 2-way 0° splitter/combiner designed for wideband operation from DC to 18 GHz supporting many applications requiring high performance across a wide frequency range including all the LTE bands through WiMax and WiFi, as well as instrumentation and more. This model provides excellent power handling up to 0.6W (as a splitter/combiner) with good isolation, and low phase and amplitude unbalance in a tiny 5 x 5mm QFN package. Manufactured using GaAs IPD technology, the EP2RKU+ not only provides a repeatable performance, but also a high level of ESD protection.

## Key Features

Feature	Advantages
Wideband, DC to 18 GHz	One power splitter can be used in a HF thru, LTE bands, WiMax and WiFi, saving component count. Also ideal for wideband applications such as military and instrumentation.
High isolation, 20 dB typ. at 12 GHz Excellent power handling, 0.6W as a splitter / combiner	In power combiner applications, half the power is dissipated internally. EP2RKU+ is designed to handle 0.6W internal dissipation as a combiner allowing reliable operation without excessive temperature rise.
Excellent Amplitude unbalance, 0.1 dB typ. Good phase unbalance, 3.3° typ. at 12 GHz	Ideal for Applications such as WMO & phased array radars
Tiny size, 5 x 5mm QFN package	Tiny footprint saves space in dense layouts while providing low inductance, repeatable transitions, and excellent thermal contact to the PCB.

2 Way-0° 50Ω DC to 18 GHz

**Features**

- Wide bandwidth, DC to 18 GHz
- Excellent isolation, 20 dB typ. at 12 GHz
- Excellent amplitude unbalance, 0.1 dB typ. to 18 GHz
- Good phase unbalance, 3.3 at 12 GHz
- Small size, 5x5 mm
- Aqueous washable
- Patent pending

**Applications**

- WIMAX
- ISM
- Instrumentation
- Radar
- WLAN
- Satellite communications
- LTE



Generic photo used for illustration purposes only

CASE STYLE: DG1677-2

**+RoHS Compliant**

The +Suffix identifies RoHS Compliance. See our web site for RoHS Compliance methodologies and qualifications

**Electrical Specifications<sup>1</sup> at 25°C**

Parameter	Frequency (GHz)	Min.	Typ.	Max.	Unit
Frequency Range		DC		18	GHz
Insertion Loss <sup>2</sup> above 3.0 dB	DC - 4	—	3.2	3.9	dB
	4 - 18	—	3.3	3.9	
Isolation	DC - 4	8	13.1	—	dB
	4 - 18	14	26.1	—	
Phase Unbalance	DC - 4	—	0.3	4	Degree
	4 - 18	—	1.1	14	
Amplitude Unbalance	DC - 4	—	0.01	0.3	dB
	4 - 18	—	0.02	0.4	
VSWR (Port S)	DC - 4	—	1.5	—	:1
	4 - 18	—	1.3	—	
VSWR (Port 1-2)	DC - 4	—	1.4	—	:1
	4 - 18	—	1.4	—	
Power Handling	As a splitter	DC - 18	—	0.6	W
	As a combiner <sup>3</sup>	DC - 18	—	0.6	

1. Tested on Mini-Circuits Test Board TB-EP2RKUC+

2. De-embedded from Test Board Loss.

3. As a combiner of non-coherent signals, max. power per port is 0.3 watt

**Maximum Ratings**

Parameter	Ratings
Operating Temperature	-55°C to 105°C
Storage Temperature	-65°C to 150°C

Permanent damage may occur if any of these limits are exceeded.

**Pad Connections**

Function	Pad Number
SUM PORT	21
PORT 1	12
PORT 2	29
GROUND	11,13,20,22,28,30 & Paddle
NOT USED, GROUND EXTERNALLY	1-10, 14-19, 23-27, 31-32

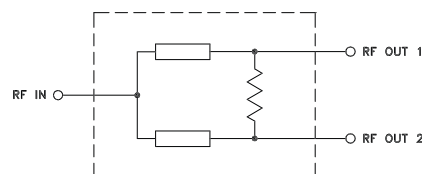
**Simplified Electrical Schematic**

Typical Performance Data

Frequency (MHz)	Total Loss (dB)		Amplitude Unbalance (dB)	Isolation (dB)	Phase Unbalance (deg.)	VSWR S	VSWR 1	VSWR 2
	S-1	S-2						
100	5.97	5.97	0.00	9.8	0.0	1.5	1.0	1.0
700	6.03	6.02	0.01	10.2	0.2	1.5	1.1	1.1
1000	6.04	6.02	0.01	10.7	0.2	1.5	1.2	1.2
2000	6.09	6.08	0.01	12.9	0.6	1.5	1.4	1.4
3000	6.28	6.28	0.00	15.1	0.8	1.5	1.6	1.6
4000	6.39	6.39	0.00	17.2	1.0	1.6	1.7	1.7
7000	6.32	6.33	0.01	29.8	1.8	1.3	1.5	1.5
9000	6.29	6.27	0.03	31.3	2.5	1.3	1.3	1.3
10000	6.23	6.23	0.00	24.7	2.9	1.2	1.2	1.2
11000	6.31	6.33	0.02	21.4	3.1	1.4	1.3	1.3
12000	6.34	6.36	0.02	20.7	3.3	1.4	1.2	1.3
14000	6.14	6.19	0.05	17.9	3.8	1.1	1.0	1.1
16000	6.12	6.11	0.02	22.2	4.1	1.3	1.4	1.3
18000	6.19	6.20	0.01	28.3	5.1	1.1	1.3	1.3

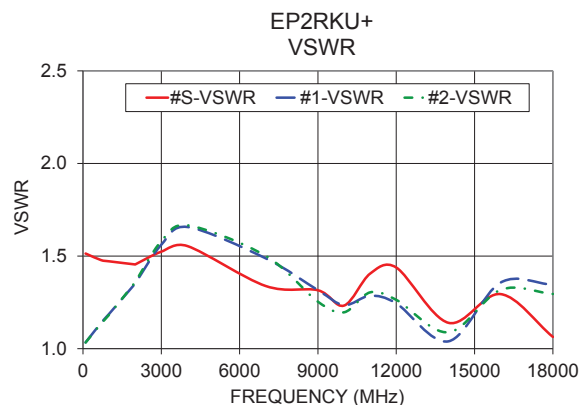
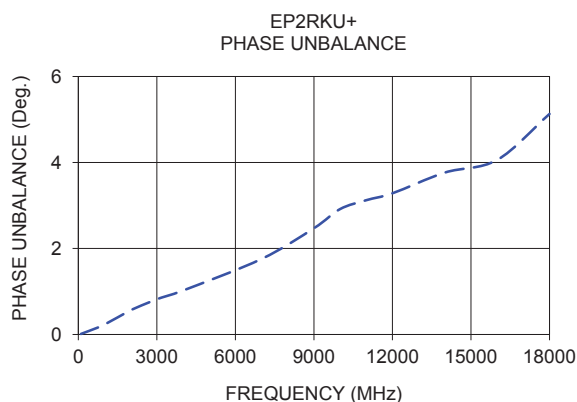
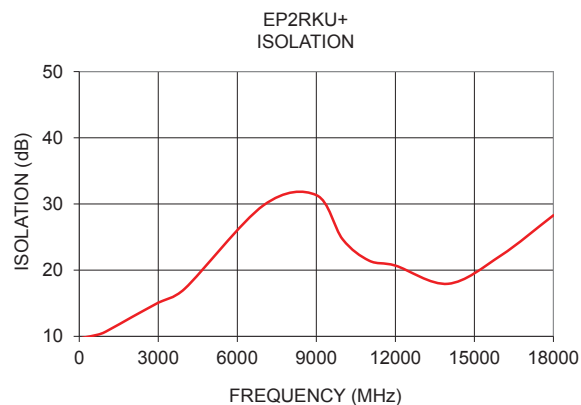
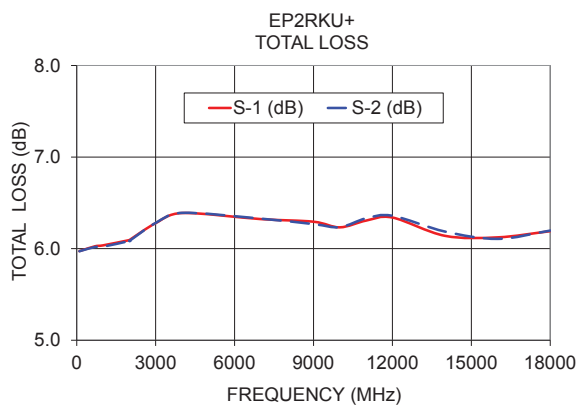

Additional Detailed Technical Information	
additional information is available on our dash board. To access this information <a href="#">click here</a>	
Performance Data	Data Table
	Swept Graphs
	S-Parameter (S3P Files) Data Set (.zip file)
Case Style	DG1677-2 Plastic package, exposed paddle lead finish: Matte Tin
Tape & Reel Standard quantities available on reel	F68 7" reels with 20, 50, 100, 200, 500 and 1000 devices
Suggested Layout for PCB Design	PL-648
Evaluation Board	TB-EP2RKU+ (Without connectors) TB-EP2RKUC+ (With connectors)
Environmental Ratings	ENV08T1

**ESD Rating**

Human Body Model (HBM): Class 2 (Pass 2000V) in accordance with ANSI/ESD STM 5.1 - 2001

**Product Marking**

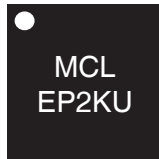

Marking may contain other features or characters for internal lot control

**MSL Test Flow Chart**

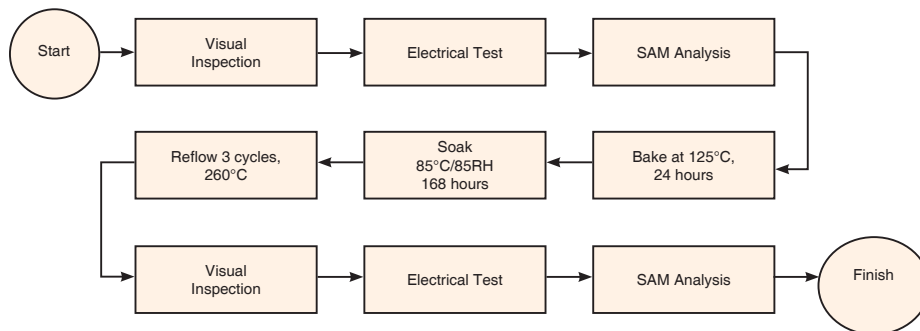

**Additional Notes**

- A. Performance and quality attributes and conditions not expressly stated in this specification document are intended to be excluded and do not form a part of this specification document.
- B. Electrical specifications and performance data contained in this specification document are based on Mini-Circuit's applicable established test performance criteria and measurement instructions.
- C. The parts covered by this specification document are subject to Mini-Circuits standard limited warranty and terms and conditions (collectively, "Standard Terms"); Purchasers of this part are entitled to the rights and benefits contained therein. For a full statement of the Standard Terms and the exclusive rights and remedies thereunder, please visit Mini-Circuits' website at [www.minicircuits.com/MCLStore/terms.jsp](http://www.minicircuits.com/MCLStore/terms.jsp)