

CMPA1D1E025F

25 W, 13.75 - 14.5 GHz, 40 V, Ku-Band GaN MMIC, Power Amplifier

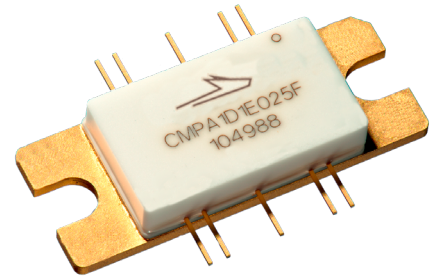

PN: CMPA1D1E025F
Package Type: 440213

Description

WolfSpeed's CMPA1D1E025F is a gallium nitride (GaN) High Electron Mobility Transistor (HEMT) based monolithic microwave integrated circuit (MMIC) on a silicon carbide (SiC) substrate, using a 0.25 μm gate length fabrication process. The Ku-Band 25W MMIC is targeted for commercial Ku-Band satellite communications applications. It offers high gain and superior efficiency while meeting OQPSK linearity required for Satcom applications at 3dB backed off P_{SAT} operations. This Ku-Band MMIC is available in a 10 lead, 25 mm x 9.9 mm metal/ceramic flanged package.

Typical Performance Over 13.75-14.5 GHz ($T_c = 25^\circ\text{C}$)

Parameter	13.75 GHz	14.0 GHz	14.25 GHz	14.5 GHz	Units
Small Signal Gain	24	24.5	24.5	24	dB
Linear Output Power	24	23	21	20	W
Power Gain	21	21	20	20	dB
Power Added Efficiency	22	20	18	18	%

Note:

¹ Measured at -30 dBc, 1.6 MHz from carrier, in the CMPA1D1E025F-AMP under OQPSK modulation, 1.6 Msps, PN23, Alpha Filter = 0.2

Features

- 24 dB Small Signal Gain
- 40 W Typical Pulsed P_{SAT}
- Operation up to 40 V
- 20 W linear power under OQPSK
- Class A/B high gain, high efficiency 50 ohm MMIC Ku-Band high power amplifier

Applications

- Satellite Communication Uplink





Absolute Maximum Ratings (not simultaneous)

Parameter	Symbol	Rating	Units	Conditions
Drain-source Voltage	V_{DSS}	120	V_{DC}	25°C
Gate-source Voltage	V_{GS}	-10, +2		
Power Dissipation	P_{DISS}	94	W	
Storage Temperature	T_{STG}	-55, +150	°C	
Operating Junction Temperature	T_J	225		
Maximum Forward Gate Current	I_{GMAX}	10	mA	25°C
Soldering Temperature ¹	T_S	245	°C	
Screw Torque	τ	40	in-oz	
Thermal Resistance, Junction to Case	$R_{\theta JC}$	1.5	°C/W	$P_{DISS} = 94 \text{ W}$, 85°C
Case Operating Temperature	T_C	-40, +85	°C	CW, $P_{DISS} = 94 \text{ W}$

Note: Refer to the Application Note on soldering at wolfspeed.com/rf/document-library

Electrical Characteristics (Frequency = 13.75 GHz to 14.5 GHz unless otherwise stated; $T_C = 25^\circ\text{C}$)

Characteristics	Symbol	Min.	Typ.	Max.	Units	Conditions
DC Characteristics¹						
Gate Threshold	$V_{GS(th)}$	-3.4	-3.0	-2.6	V	$V_{DS} = 10 \text{ V}$, $I_D = 18.2 \text{ mA}$
Gate Quiescent Voltage	$V_{GS(Q)}$	—	-2.7	—		$V_{DS} = 40 \text{ V}$, $I_D = 240 \text{ mA}$
Saturated Drain Current ²	I_{DS}	13.1	18.2	—	A	$V_{DS} = 6.0 \text{ V}$, $V_{GS} = 2.0 \text{ V}$
Drain-Source Breakdown Voltage	V_{BR}	100	—	—	V	$V_{GS} = -8 \text{ V}$, $I_D = 18.2 \text{ mA}$
RF Characteristics³						
Small Signal Gain	S21	20.9	24	—	dB	$V_{DD} = 40 \text{ V}$, $I_{DQ} = 240 \text{ mA}$, $P_{IN} = -15 \text{ dBm}$
Input Return Loss	S11	—	-7	-6		
Output Return Loss	S22	—				
Output Mismatch Stress	VSWR	—	—	5:1	Ψ	No damage at all phase angles, $V_{DD} = 40 \text{ V}$, $I_{DQ} = 240 \text{ mA}$, $P_{OUT} = 41 \text{ dBm}$ OQPSK

Notes:

¹ Measured on-wafer prior to packaging

² Scaled from PCM data

³ Measured in the CMPA1D1E025F-AMP



Electrical Characteristics Continued (T_c = 25°C)

Characteristics	Symbol	Min.	Typ.	Max.	Units	Conditions
RF Characteristics^{1,2,3,4}						
Power Added Efficiency at 13.75 GHz	PAE	14.5	20.5	–	%	V _{DD} = 40 V, I _{DQ} = 240 mA
Power Added Efficiency at 14.5 GHz		12.5	18	–		
Power Gain at 13.75 GHz	G _p	19.25	23	–	dB	
Power Gain at 14.5 GHz		17.75	22	–		
OQPSK Linearity at 13.75 GHz	ACLR	–	-40	-32	dBc	
OQPSK Linearity at 14.5 GHz		–	-38	-30.5		

Notes:

¹ Measured in the CPMA1D1E025F-AMP

² Under OQPSK modulated signal, 1.6 Msps, PN23, Alpha Filter = 0.2

³ Measured at P_{AVE} = 41 dBm

⁴ Fixture loss de-embedded

Electrostatic Discharge (ESD) Classifications

Parameter	Symbol	Class	Classification Level	Test Methodology
Human Body Model	HBM	TBD	ANSI/ESDA/JEDEC JS-001 Table 3	JEDEC JESD22 A114-D
Charge Device Model	CDM	TBD	ANSI/ESDA/JEDEC JS-002 Table 3	JEDEC JESD22 C101-C



Typical Performance

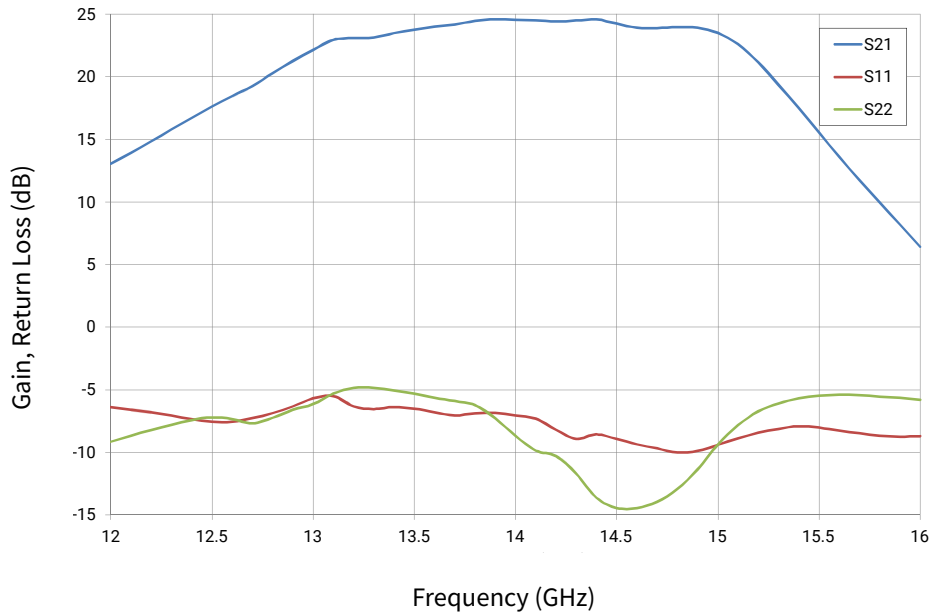

Figure 1. Small Signal S-Parameters CMPA1D1E025F in Test Fixture
 $V_{DD} = 40\text{ V}$, $I_{DQ} = 240\text{ mA}$, $T_{CASE} = 25^\circ\text{C}$

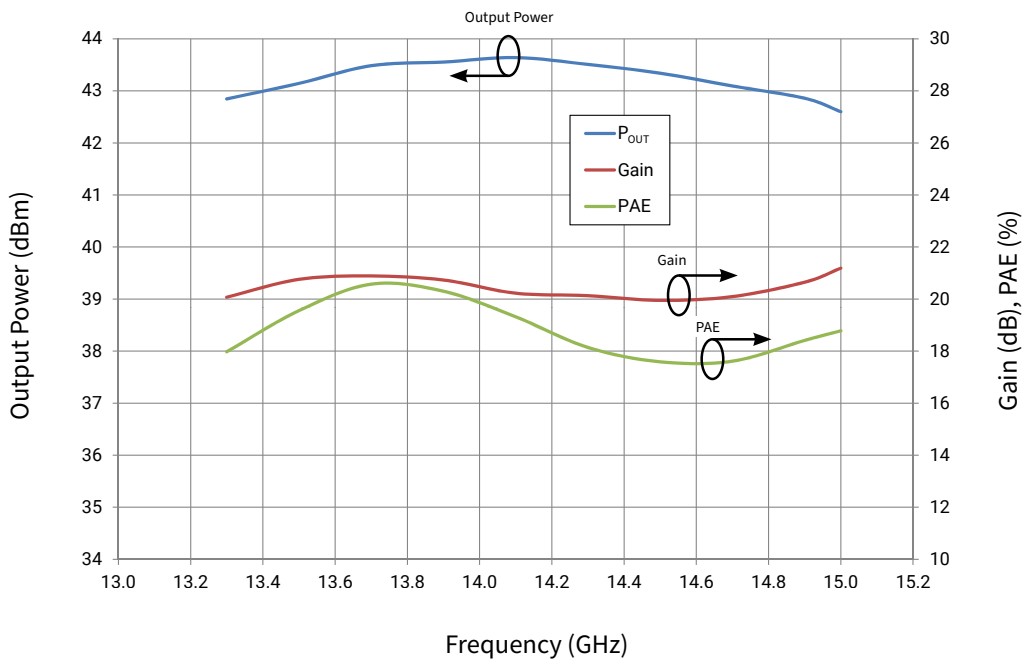

Figure 2. Modulated @ Spectral Regrowth = -30 dBc, 1.6 MHz from Carrier
 1.6 Msps OQPSK Modulation
 $V_{DD} = 40\text{ V}$, $I_{DQ} = 240\text{ mA}$, $T_{CASE} = 25^\circ\text{C}$



Typical Performance

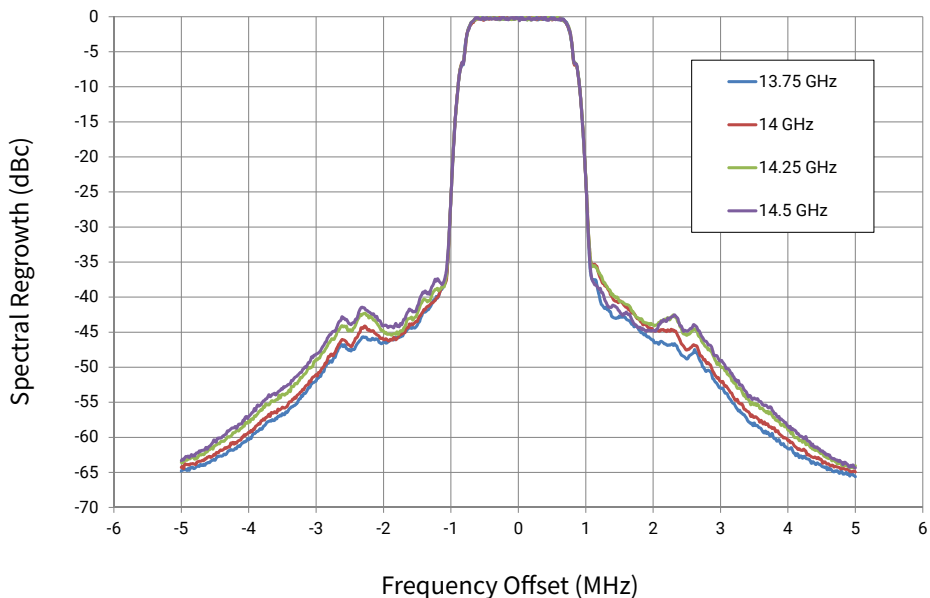

Figure 3. Spectral Mask @ Average Output Power = 41 dBm
 1.6 Msps QPSK Modulation
 $V_{DD} = 40\text{ V}$, $I_{DQ} = 240\text{ mA}$, $T_{CASE} = 25^\circ\text{C}$

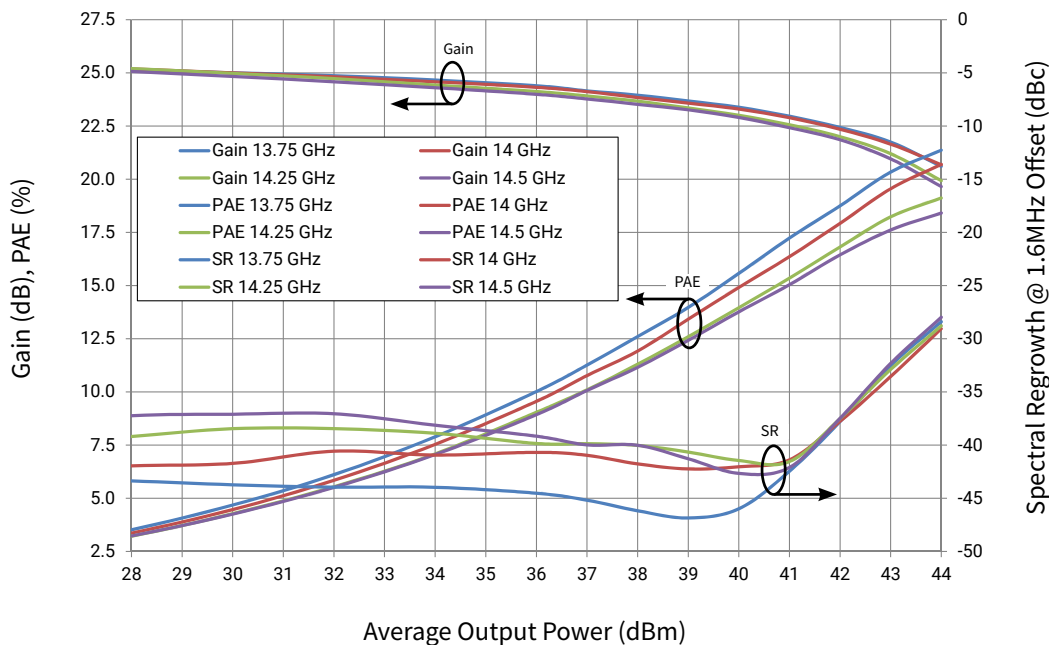

Figure 4. CMPA1D1E025F Modulated Power Sweep
 1.6 Msps QPSK Modulation
 $V_{DD} = 40\text{ V}$, $I_{DQ} = 240\text{ mA}$, $T_{CASE} = 25^\circ\text{C}$

Typical Performance

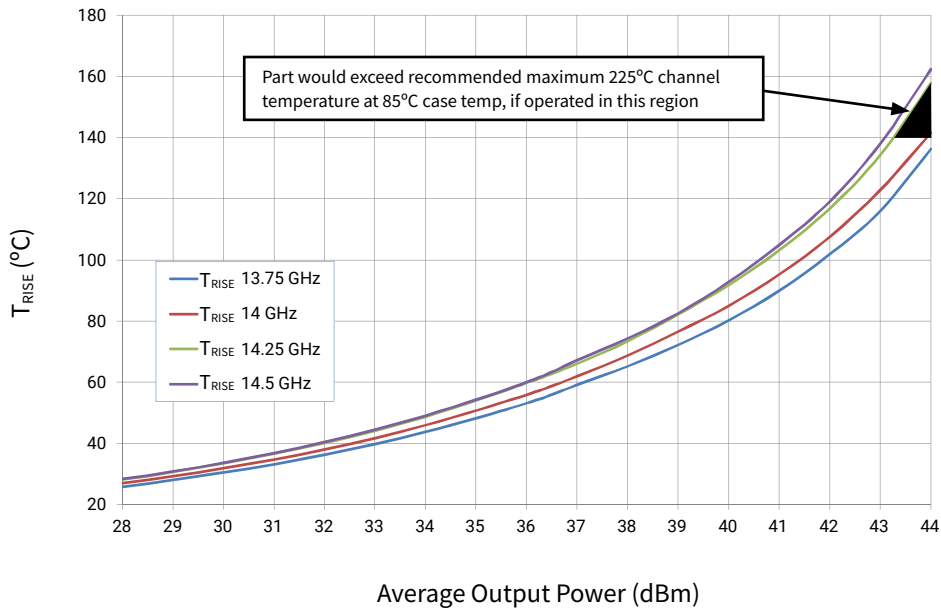

Figure 5. Modulated Power Sweep
 1.6 Msps OQPSK Modulation
 $V_{DD} = 40\text{ V}$, $I_{DQ} = 240\text{ mA}$, $T_{CASE} = 25^\circ\text{C}$

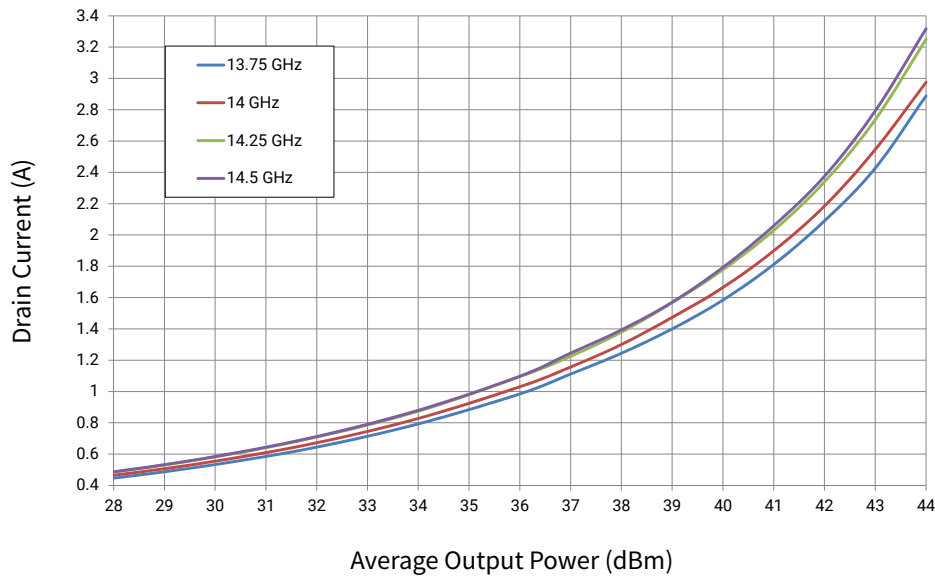

Figure 6. CMPA1D1E025F Modulated Power Sweep
 1.6 Msps OQPSK Modulation
 $V_{DD} = 40\text{ V}$, $I_{DQ} = 240\text{ mA}$, $T_{CASE} = 25^\circ\text{C}$



Typical Performance

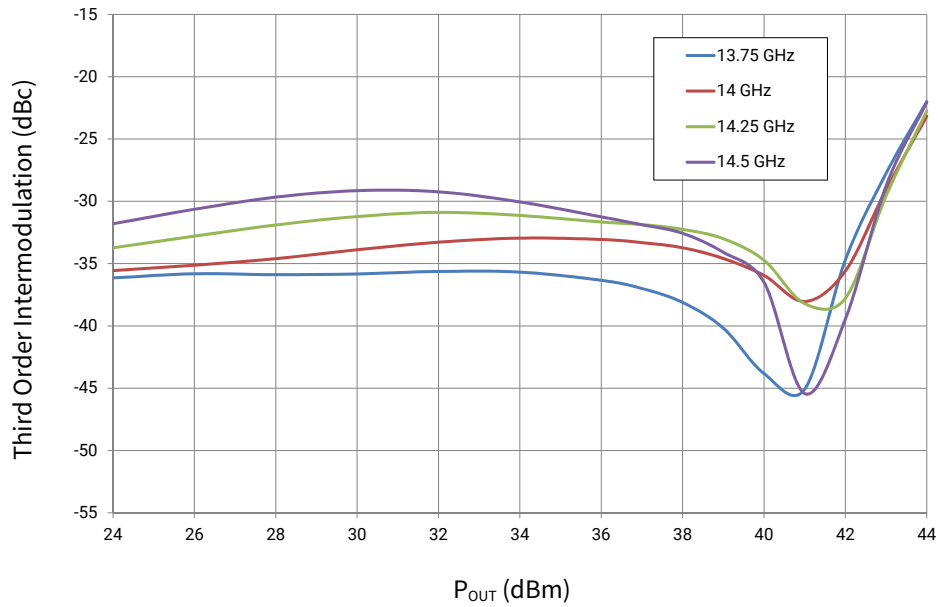

Figure 7. CMPA1D1E025F Two Tone Power Sweep
 IMD3 @ 1 MHz Carrier Spacing
 $V_{DD} = 40\text{ V}$, $I_{DQ} = 240\text{ mA}$, $T_{CASE} = 25^\circ\text{C}$

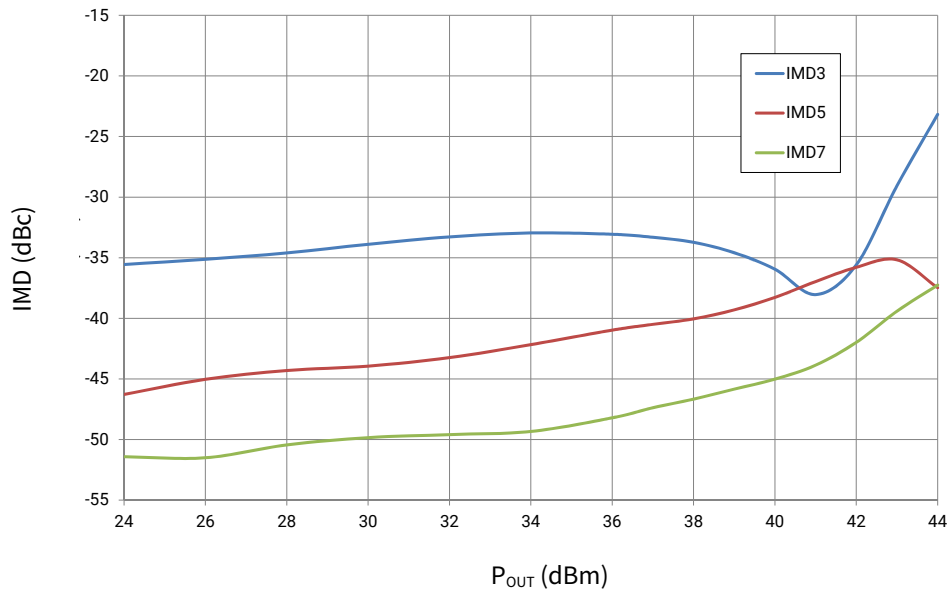

Figure 8. Two Tone Power Sweep
 IMD @ 1 MHz Carrier Spacing, 14 GHz
 $V_{DD} = 40\text{ V}$, $I_{DQ} = 240\text{ mA}$, $T_{CASE} = 25^\circ\text{C}$



Typical Performance

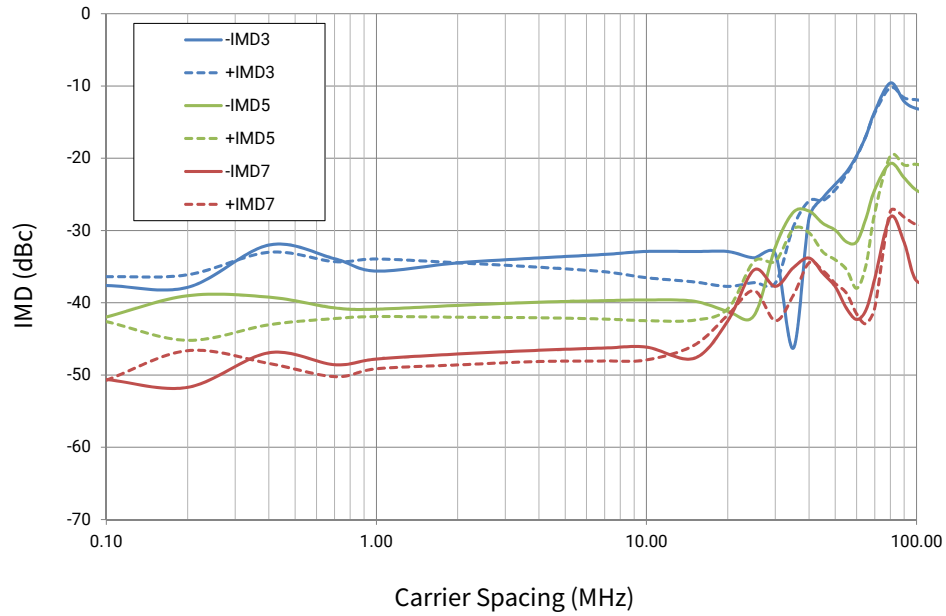

Figure 9. Two Tone Carrier Spacing Sweep @ 38 dBm Average Output Power, 14 GHz
 $V_{DD} = 40\text{ V}$, $I_{DQ} = 1\text{ A}$, $T_{CASE} = 25^\circ\text{C}$

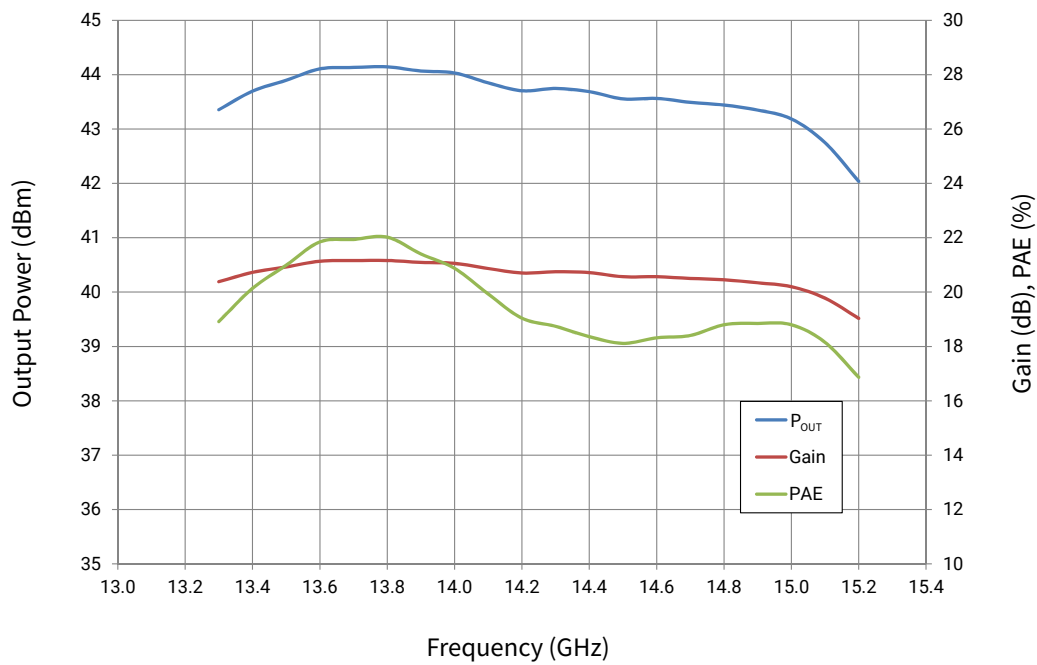

Figure 10. CW vs Frequency @ $P_{IN} = 23\text{ dBm}$
 $V_{DD} = 40\text{ V}$, $I_{DQ} = 240\text{ mA}$, $T_{CASE} = 25^\circ\text{C}$



Typical Performance

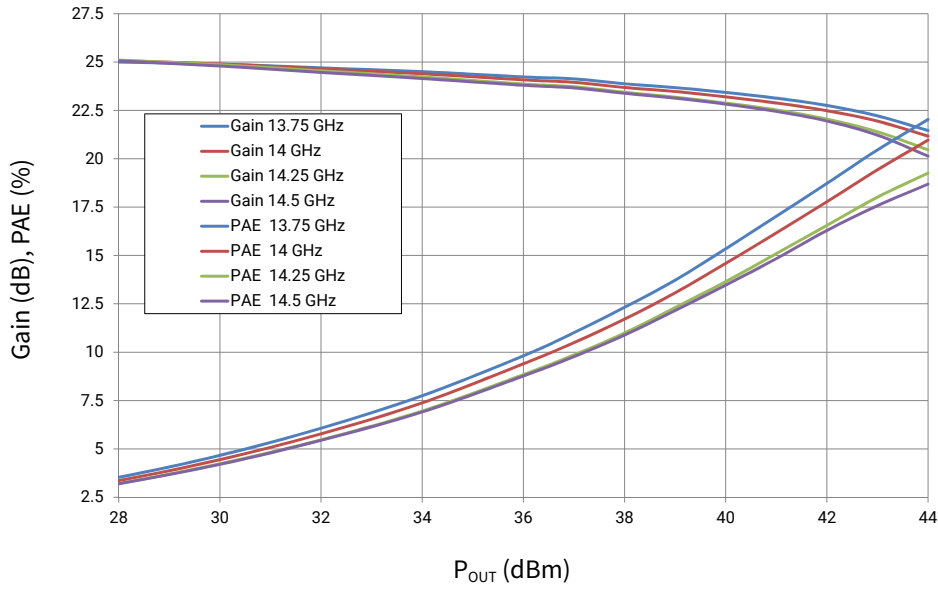

Figure 11. CW Power Sweep CMPA1D1E025F in Test Fixture
 $V_{DD} = 40V$, $I_{DQ} = 240$ mA, $T_{CASE} = 25^{\circ}C$

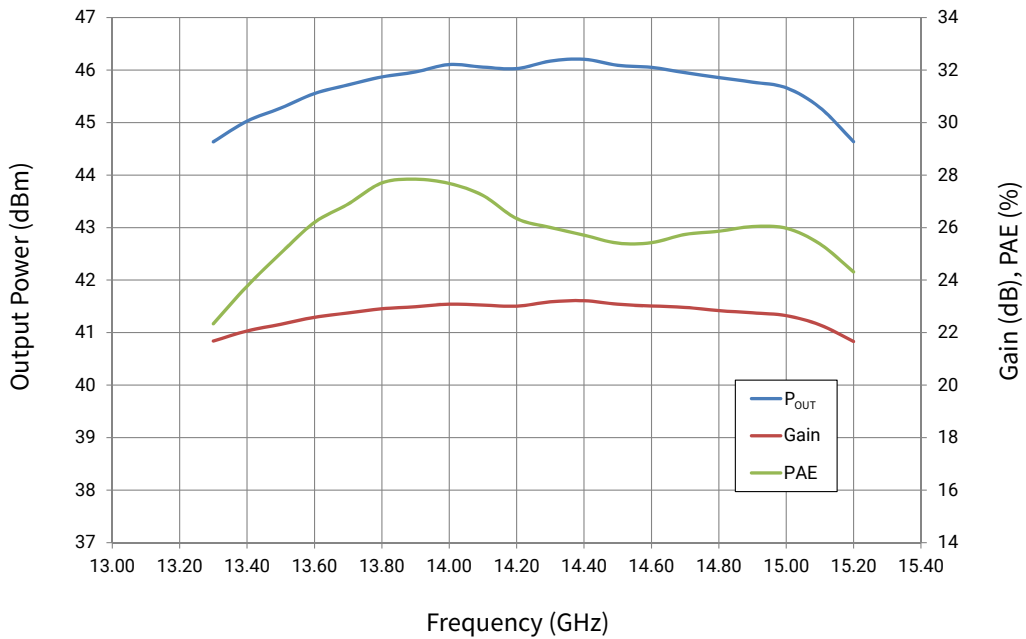

Figure 12. Pulsed vs Frequency @ $P_{IN} = 23$ dBm CMPA1D1E025F in Test Fixture
 $V_{DD} = 40$ V, $I_{DQ} = 240$ mA, 100 μ s Pulse Width, 10% Duty Cycle, $T_{CASE} = 25^{\circ}C$



Typical Performance

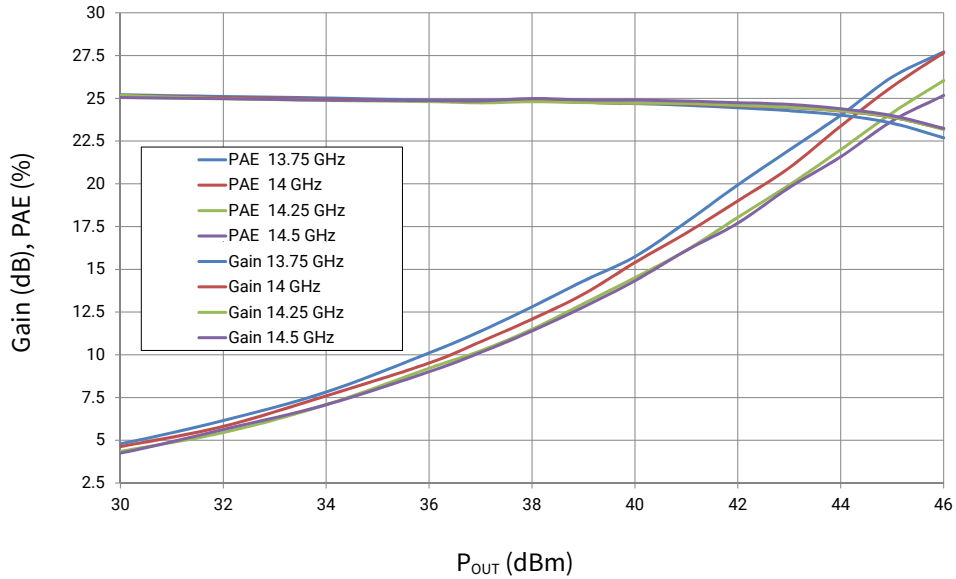

Figure 13. Pulsed Power Sweep CMPA1D1E025F in Test Fixture
 10% Duty, 100μs Pulse Width
 $V_{DD} = 40V$, $I_{DQ} = 240\text{ mA}$, $T_{CASE} = 25^{\circ}C$

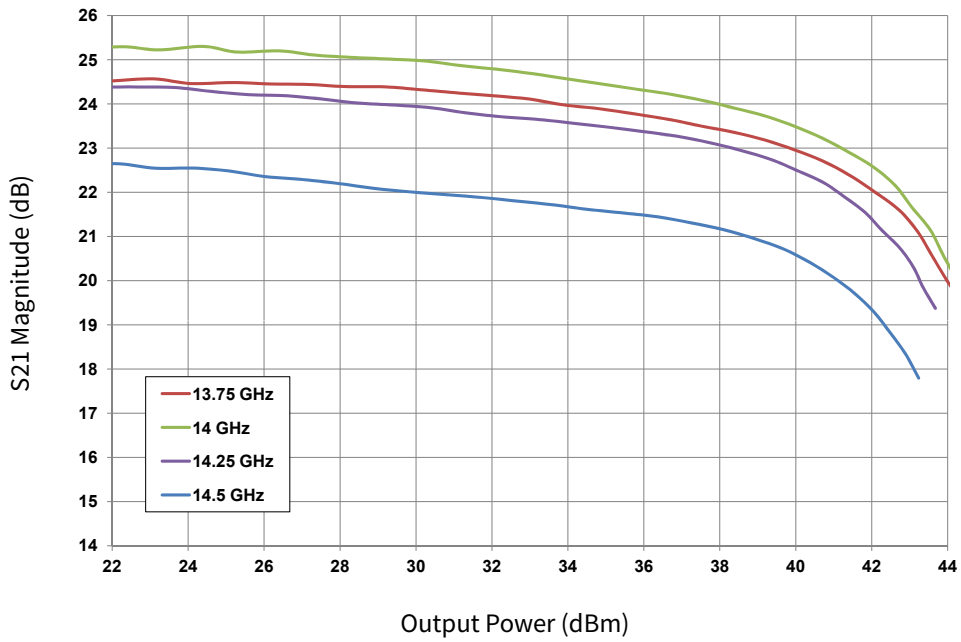

Figure 14. AM-AM
 $V_{DD} = 40\text{ V}$, $I_{DQ} = 240\text{ mA}$, $T_{CASE} = 25^{\circ}C$



Typical Performance

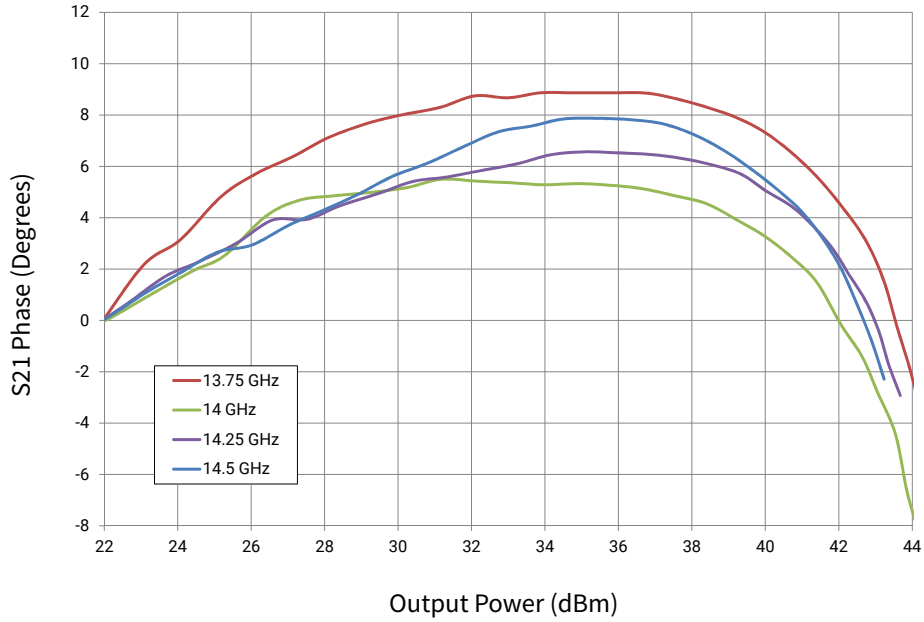

Figure 15. AM-PM
 $V_{DD} = 40V, I_{DQ} = 240\text{ mA}, T_{CASE} = 25^{\circ}C$

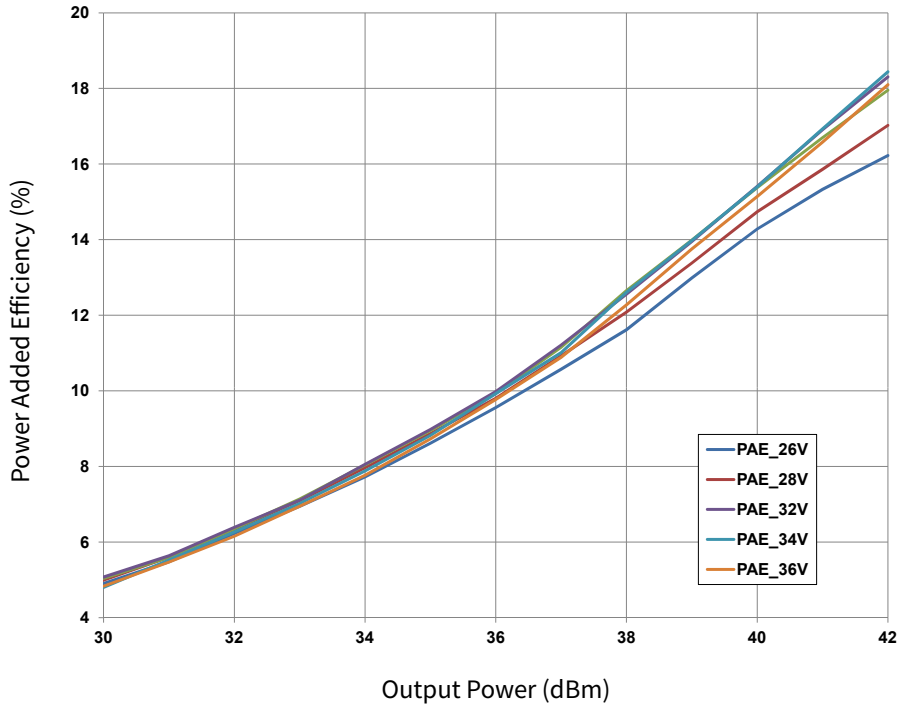

Figure 16. CPM1D1E025F Modulated Power Sweep (PAE and G_p)
 1.6 Msps OQPSK Modulation, Frequency = 14 GHz
 $V_{DD} = 26-36\text{ V}, I_{DQ} = 150\text{ mA}, T_{CASE} = 25^{\circ}C$



Typical Performance

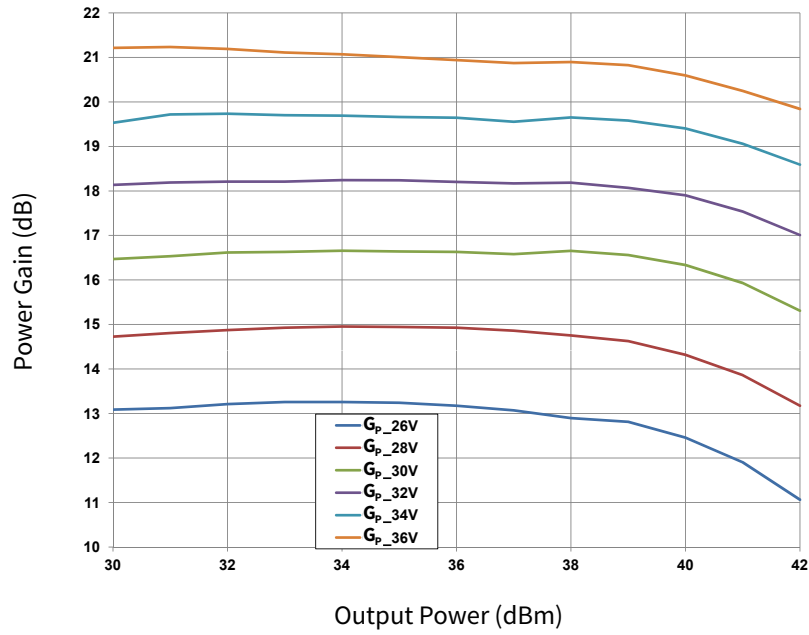

Figure 17. CMPA1D1E025F Modulated Power Sweep (G_p)
 1.6 Msps OQPSK Modulation, Frequency = 14 GHz
 $V_{DD} = 26-36\text{ V}$, $I_{DQ} = 150\text{ mA}$, $T_{CASE} = 25^\circ\text{C}$

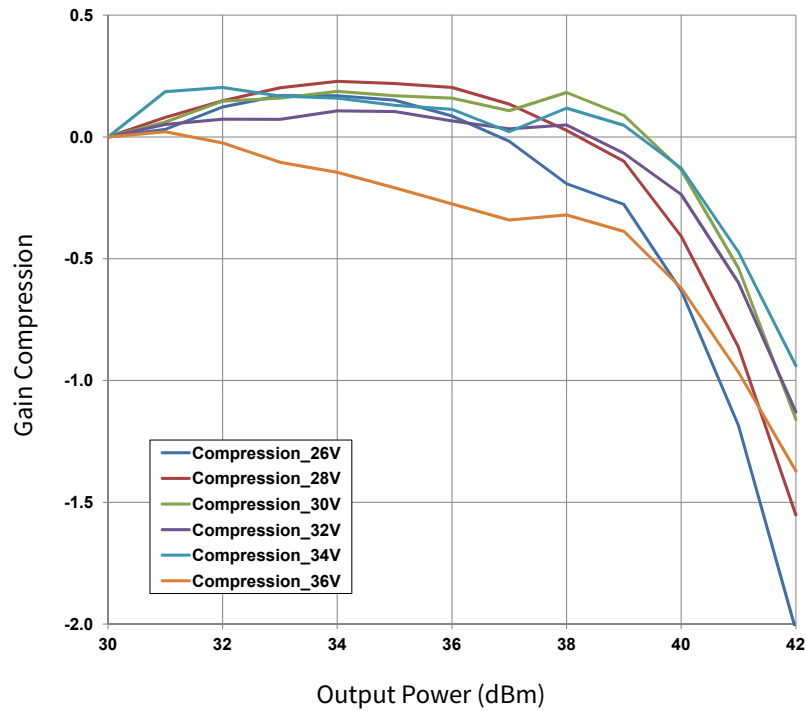
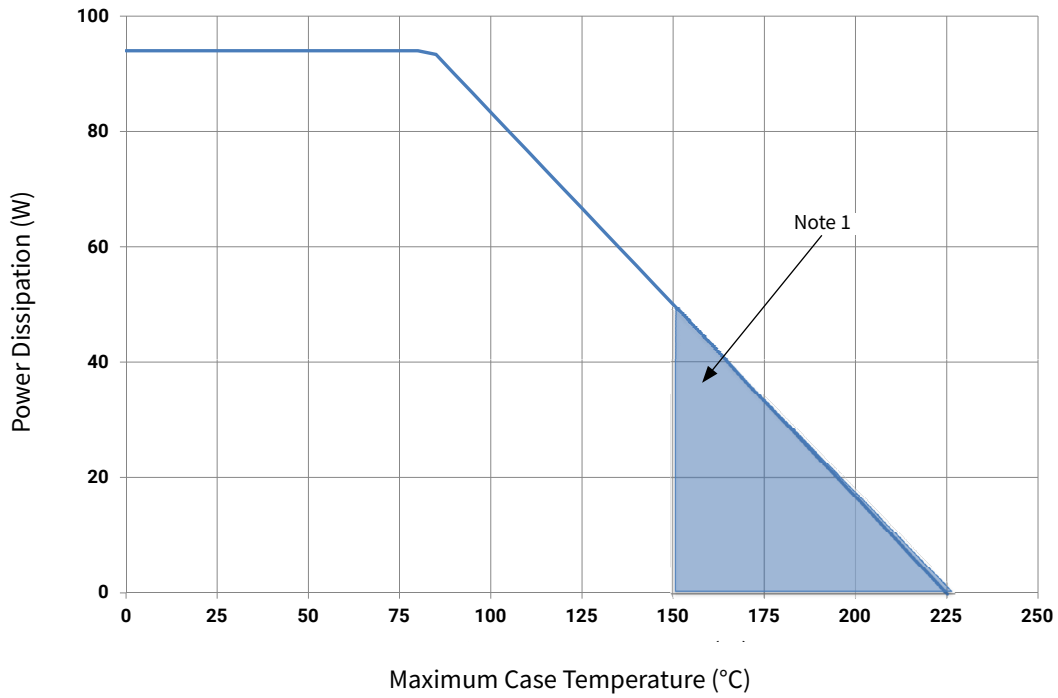

Figure 18. CMPA1D1E025F Modulated Power Sweep (Gain Compression)
 1.6 Msps OQPSK Modulation, Frequency = 14 GHz
 $V_{DD} = 26-36\text{ V}$, $I_{DQ} = 150\text{ mA}$, $T_{CASE} = 25^\circ\text{C}$



Typical Performance

CMPA1D1E025F Power Dissipation De-rating Curve



Note 1. Area exceeds Maximum Case Operating Temperature (See Page 2)



CMPA1D1E025F-AMP Demonstration Amplifier Circuit Bill of Materials

Designator	Description	Qty
C5	CAP ELECT 100µF 80V AFK SMD	1
C1, C2	CAP, 33000pF, 0805, 100V, X7R	2
C3, C4	CAP, 2.2µF, 100V, 10%, X7R, 1210	2
C6, C7	CAP, 1.0µF, 100V, 10%, X7R, 1210	2
J1, J2	CONN, SMA, PANEL MOUNT JACK, FLANGE, 4-HOLE, BLUNT POST, 20MIL	2
J4	CONN, SMB, STRAIGHT JACK RECEPTACLE, SMT, 50 OHM, Au PLATED	1
J3	HEADER RT>PLZ .1CEN LK 9POS	1
W1, W2, W3	WIRE, BLACK, 22 AWG	1
	PCB, TEST FIXTURE, TACONICS RF35P, 20 MILS	1
	2-56 SOC HD SCREW 3/16 SS	4
-	#2 SPLIT LOCKWASHER SS	4
Q1	CMPA1D1E025F	1

CMPA1D1E025F-AMP Demonstration Amplifier Circuit

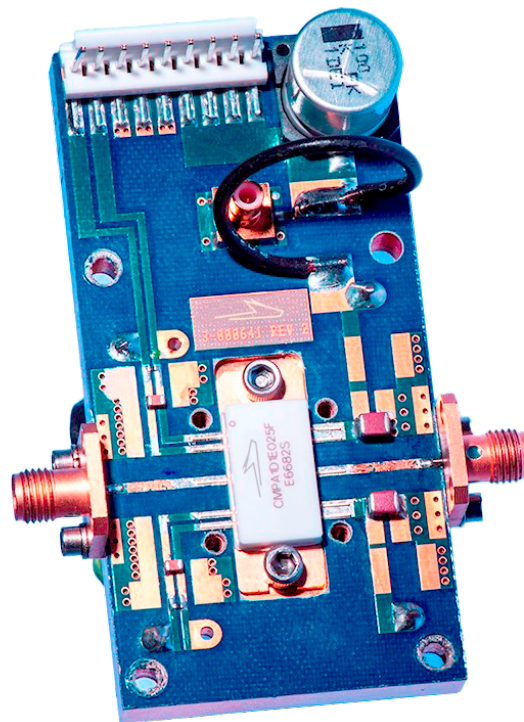



CMPA1D1E025F-AMP Demonstration Amplifier Circuit Schematic

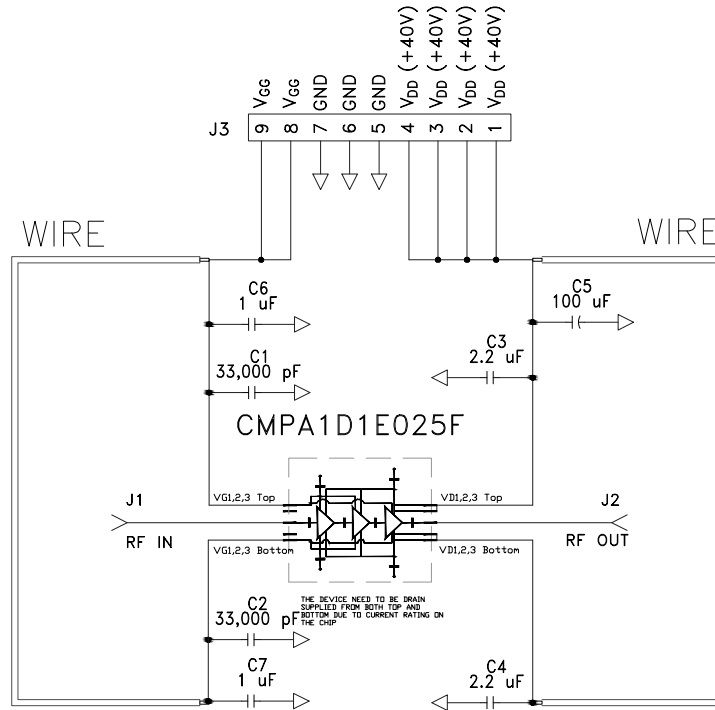

CMPA1D1E025F-AMP Demonstration Amplifier Circuit Outline

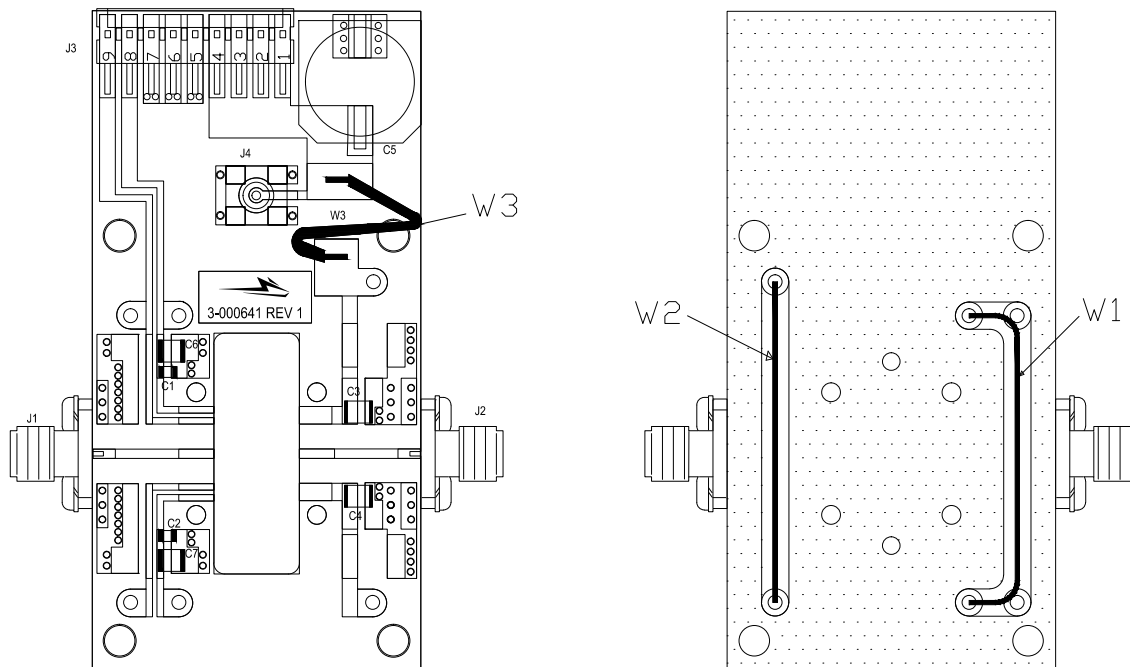



Product Dimensions CPM1D1E025F (Package Type – 440213)

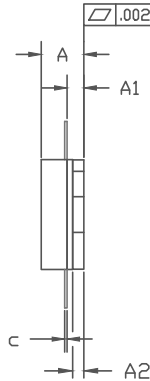
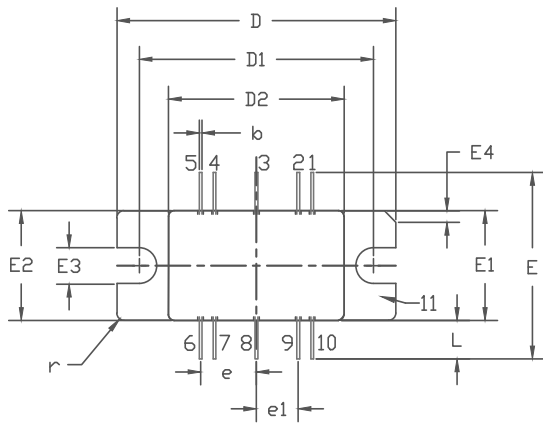

PIN 1: GATE BIAS 6: DRAIN BIAS
 2: GATE BIAS 7: DRAIN BIAS
 3: RF IN 8: RF OUT
 4: GATE BIAS 9: DRAIN BIAS
 5: GATE BIAS 10: DRAIN BIAS
 11: SOURCE

NOTES:

1. DIMENSIONING AND TOLERANCING PER ANSI Y14.5M - 1994.
2. CONTROLLING DIMENSION: INCH.
3. ADHESIVE FROM LID MAY EXTEND A MAXIMUM OF 0.020" BEYOND EDGE OF LID.
4. LID MAY BE MISALIGNED TO THE BODY OF PACKAGE BY A MAXIMUM OF 0.008" IN ANY DIRECTION.

DIM	INCHES		MILLIMETERS		NOTES
	MIN	MAX	MIN	MAX	
A	0.148	0.168	3.76	4.27	
A1	0.055	0.065	1.40	1.65	
A2	0.035	0.045	0.89	1.14	
b	0.01 TYP		0.254 TYP		10x
c	0.007	0.009	0.18	0.23	
D	0.995	1.005	25.27	25.53	
D1	0.835	0.845	21.21	21.46	
D2	0.623	0.637	15.82	16.18	
E	0.653 TYP		16.59 TYP		
E1	0.380	0.390	9.65	9.91	
E2	0.380	0.390	9.65	9.91	
E3	0.120	0.130	3.05	3.30	
E4	0.035	0.045	0.89	1.14	45° CHAMFER
e	0.200 TYP		5.08 TYP		4x
e1	0.150 TYP		3.81 TYP		4x
L	0.115	0.155	2.92	3.94	10x
r	0.025 TYP		.635 TYP		3x

Pin Number	Qty.
1	Gate Bias
2	NC
3	RF IN
4	NC
5	Gate Bias
6	Drain Bias
7	
8	RF OUT
9	Drain Bias
10	
11	Source

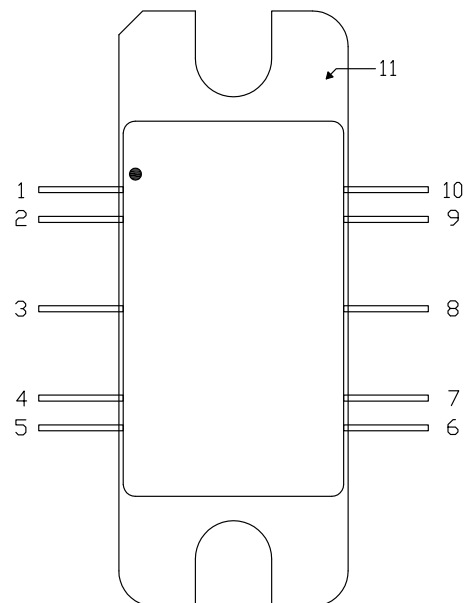



Part Number System

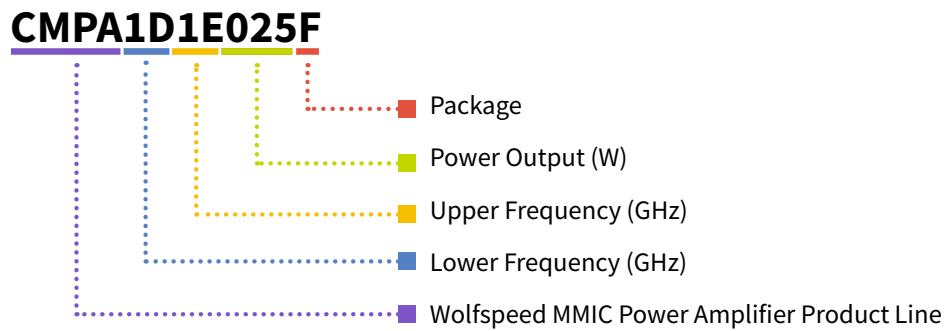

Table 1.

Parameter	Value	Units
Lower Frequency	13.75	GHz
Upper Frequency ¹	14.5	
Power Output	25	W
Package	Flange	—

Note:

¹ Alpha characters used in frequency code indicate a value greater than 9.9 GHz. See Table 2 for value.

Table 2.

Character Code	Code Value
A	0
B	1
C	2
D	3
E	4
F	5
G	6
H	7
J	8
K	9
Examples	1A = 10.0 GHz 2H = 27.0 GHz

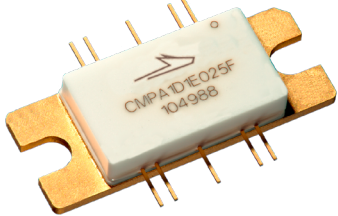
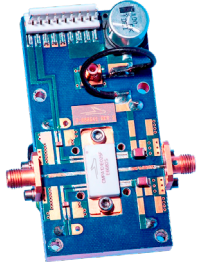

Product Ordering Information

Order Number	Description	Unit of Measure	Image
CPA1D1E025F	GaN HEMT	Each	
CPA1D1E025F-AMP	Test board with GaN MMIC installed	Each	

**For more information, please contact:**

4600 Silicon Drive
Durham, NC 27703 USA
Tel: +1.919.313.5300
www.wolfspeed.com/RF

Sales Contact
RFSales@wolfspeed.com

RF Product Marketing Contact
RFMarketing@wolfspeed.com

Notes & Disclaimer

Specifications are subject to change without notice. “Typical” parameters are the average values expected by Wolfspeed in large quantities and are provided for information purposes only. Wolfspeed products are not warranted or authorized for use as critical components in medical, life-saving, or life-sustaining applications, or other applications where a failure would reasonably be expected to cause severe personal injury or death. No responsibility is assumed by Wolfspeed for any infringement of patents or other rights of third parties which may result from use of the information contained herein. No license is granted by implication or otherwise under any patent or patent rights of Wolfspeed.

©2014-2022 Wolfspeed, Inc. All rights reserved. Wolfspeed® and the Wolfstreak logo are registered trademarks and the Wolfspeed logo is a trademark of Wolfspeed, Inc.
PATENT: <https://www.wolfspeed.com/legal/patents>

The information in this document is subject to change without notice.