

| NO. CKTS | DIM. A         | DIM. B         |
|----------|----------------|----------------|
| 2        | 5.08<br>.200   | 2.54<br>.100   |
| 3        | 7.62<br>.300   | 5.08<br>.200   |
| 4        | 10.16<br>.400  | 7.62<br>.300   |
| 5        | 12.70<br>.500  | 10.16<br>.400  |
| 6        | 15.24<br>.600  | 12.70<br>.500  |
| 7        | 17.78<br>.700  | 15.24<br>.600  |
| 8        | 20.32<br>.800  | 17.78<br>.700  |
| 9        | 22.86<br>.900  | 20.32<br>.800  |
| 10       | 25.40<br>1.000 | 22.86<br>.900  |
| 11       | 27.94<br>1.100 | 25.40<br>1.000 |
| 12       | 30.48<br>1.200 | 27.94<br>1.100 |
| 13       | 33.02<br>1.300 | 30.48<br>1.200 |
| 14       | 35.56<br>1.400 | 33.02<br>1.300 |
| 15       | 38.10<br>1.500 | 35.56<br>1.400 |
| 16       | 40.64<br>1.600 | 38.10<br>1.500 |
| 17       | 43.18<br>1.700 | 40.64<br>1.600 |
| 18       | 45.72<br>1.800 | 43.18<br>1.700 |
| 19       | 48.26<br>1.900 | 45.72<br>1.800 |
| 20       | 50.80<br>2.000 | 48.26<br>1.900 |
| 21       | 53.34<br>2.100 | 50.80<br>2.000 |
| 22       | 55.88<br>2.200 | 53.34<br>2.100 |
| 23       | 58.42<br>2.300 | 55.88<br>2.200 |
| 24       | 60.96<br>2.400 | 58.42<br>2.300 |
| 25       | 63.50<br>2.500 | 60.96<br>2.400 |
| 26       | 66.04<br>2.600 | 63.50<br>2.500 |
| 27       | 68.58<br>2.700 | 66.04<br>2.600 |
| 28       | 71.12<br>2.800 | 68.58<br>2.700 |
| 29       | 73.66<br>2.900 | 71.12<br>2.800 |
| 30       | 76.20<br>3.000 | 73.66<br>2.900 |
| 31       | 78.74<br>3.100 | 76.20<br>3.000 |
| 32       | 81.28<br>3.200 | 78.74<br>3.100 |
| 33       | 83.82<br>3.300 | 81.28<br>3.200 |
| 34       | 86.36<br>3.400 | 83.82<br>3.300 |
| 35       | 88.90<br>3.500 | 86.36<br>3.400 |
| 36       | 91.44<br>3.600 | 88.90<br>3.500 |

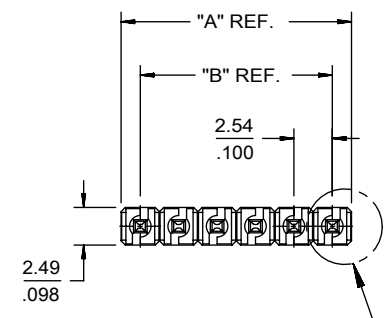

SEE DETAIL Z

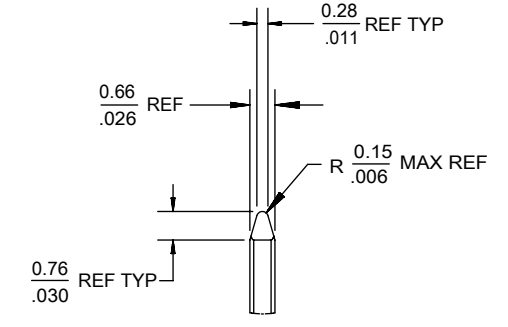

**DETAIL Y**  
SCALE 5:1  
SEE NOTE 10

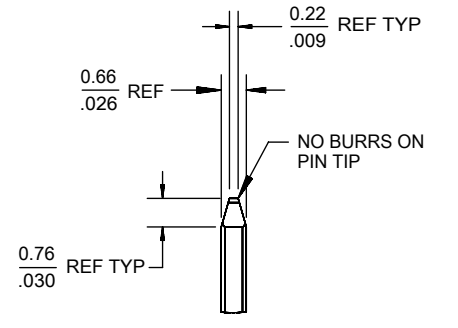

**DETAIL X**  
SCALE 5:1  
SEE NOTE 10

1.3 CENTERLINE OF PIN IN AREA SHOWN NOT TO VARY FROM  
.05 CENTERLINE OF PIN AT DATUM -D- BY MORE THAN  
(FOR DIM. X OF 12.70/.500 OR LESS) 0.20/.008 IN ANY DIRECTION.  
(FOR DIM. X OF 12.73/.501 OR MORE) 0.30/.012 IN ANY DIRECTION

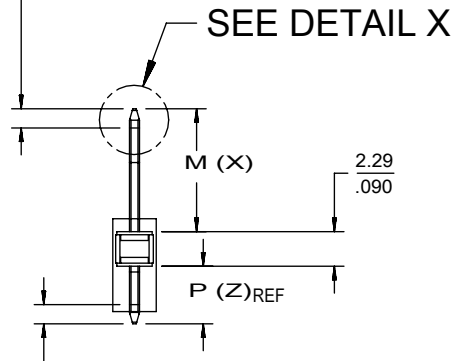

SEE DETAIL X

1.3 CENTERLINE OF PIN IN AREA SHOWN NOT TO VARY FROM  
.05 CENTERLINE OF PIN AT DATUM -E- BY MORE THAN  
0.13/.005 IN ANY DIRECTION.

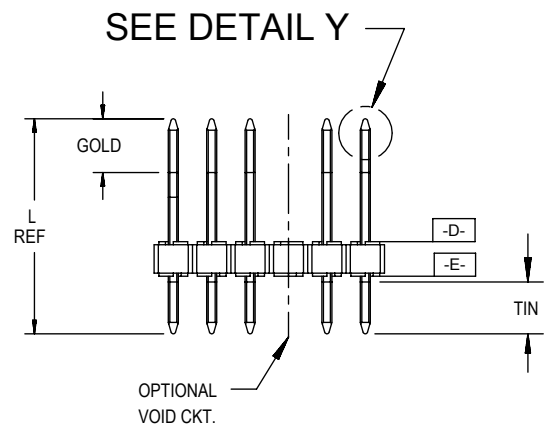

SEE DETAIL Y



- NOTES:
- MATERIAL: GLASS FILLED NYLON  
U.L. 94V-0, COLOR: BLACK
  - FINISH: (SEE LAST 3 DIGITS OF PIN NUMBER)  
(154) OVERALL TIN: 0.00254/.000100 MIN. OVER  
NICKEL: 0.00127/.000050 MIN.  
(118) OVERALL TIN: 0.00152/.000060 MIN. OVER  
NICKEL: 0.00127/.000050 MIN.  
(208) SELECT GOLD: 0.00038/.000015 MIN,  
SELECT TIN: 0.00254/.000100 MIN,  
WITH OVERALL NICKEL UNDERPLATE: 0.00127/.000050 MIN.  
(228) SELECT GOLD: 0.00076/.000030 MIN,  
SELECT TIN: 0.00254/.000100 MIN,  
WITH OVERALL NICKEL UNDERPLATE: 0.00127/.000050 MIN.
  - PRODUCT SPECIFICATION PS-10-07.
  - PACKAGING INFORMATION: SEE TABLES
  - SOLDERABILITY PER SMES-152.
  - KINK PIN OPTION NOT RECOMMENDED FOR 2 CIRCUIT PARTS.  
HOLE SIZE MAY NEED TO BE ADJUSTED FOR 2 CIRCUIT PARTS  
WITH KINK OPTION FOR PROPER INSERTION INTO THE PCB.  
SEE SMES-42003 FOR ADDITIONAL INFORMATION  
ON KINK PIN DIRECTION AND PLACEMENT.
  - HEADERS ARE NOT STACKABLE ON 2.54/.100 CENTERS.
  - PIN PUSH OUT FORCE: 3 LBS. MIN
  - THIS PART CONFORMS TO CLASS B REQUIREMENTS OF COSMETIC  
SPECIFICATION PS-45499-002.
  - PIN TIP DIMENSIONS ARE SHOWN FOR REFERENCE ONLY.  
DIMENSIONS APPLY PRIOR TO PLATING OR ASSEMBLY.
  - TEXT ON PART IS FOR REFERENCE ONLY. TEXT AND TEXT LOCATION  
MAY VARY DEPENDING ON PART NUMBER AND/OR TOOL.

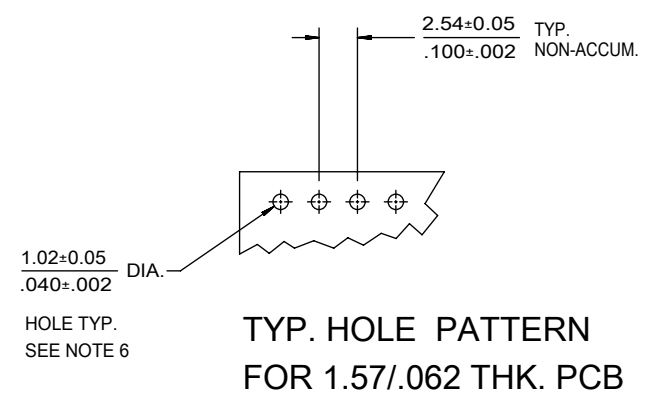

| THIS DRAWING CONTAINS INFORMATION THAT IS PROPRIETARY TO MOLEX ELECTRONIC TECHNOLOGIES, LLC AND SHOULD NOT BE USED WITHOUT WRITTEN PERMISSION |  |                 |           |   |                |  |              |                 |  |
|---|--|-----------------|-----------|---|----------------|--|--------------|-----------------|--|
| SYMBOLS   |  | DIMENSION UNITS |           | SCALE   |                | CURRENT REV DESC: GOLD LENGTH SPEC<br>CHANGED AS MIN 2.54- MAX 5.54 FOR<br>A-42375-0037/0071 |              |                 |  |
| ▽ = 0   | MM/IN  | 2:1             |           | EC NO: 689596<br>DRWN: SHRUTJ 2021/09/14<br>CHK'D: SHRUTJ 2021/12/20<br>APPR: ISHWARG 2021/12/20<br>INITIAL REVISION:<br>DRWN: SCHAFFER 2003/02/11<br>APPR: MARGULIS 2004/02/27 |                |  |              |                 |  |
| ▽ = 0   | GENERAL TOLERANCES<br>(UNLESS SPECIFIED)                   |                 |           |   |                |  |              |                 |  |
| ▽ = 0   |  | MM              | INCH      |   |                |  |              |                 |  |
| ▽ = 0   | 4 PLACES   | ±               | ±         |   |                |  |              |                 |  |
| ▽ = 0   | 3 PLACES   | ±               | ± 0.01    |   |                |  |              |                 |  |
| ▽ = 0   | 2 PLACES   | ± 0.25          | ±         |   |                |  |              |                 |  |
| ▽ = 0   | 1 PLACE  | ± 0.38          | ±         |   |                |  |              |                 |  |
| ▽ = 0   | 0 PLACES   | ±               | ±         |   |                |  |              |                 |  |
| ▽ = 0   | ANGULAR TOL ± 0.5°   |                 |           | PRODUCT CUSTOMER DRAWING<br>DOCUMENT NUMBER: SD-42375-001<br>DOC TYPE: PSD<br>DOC PART: 001<br>REVISION: V  |                |  |              |                 |  |
| ▽ = 0   | DRAFT WHERE APPLICABLE<br>MUST REMAIN<br>WITHIN DIMENSIONS |                 |           | THIRD ANGLE PROJECTION  |                | DRAWING  |              | SERIES          |  |
| ▽ = 0   |  |                 |           | B-SIZE  |                | 42375  |              | MATERIAL NUMBER |  |
|   |  |                 | SEE CHART |   | GENERAL MARKET |  | SHEET NUMBER |                 |  |
|   |  |                 |           |   |                |  | 1 OF 35      |                 |  |









| ENG. NO: A-42375-0002/0036 |                 |                    |      |                 |              |
|----------------------------|-----------------|--------------------|------|-----------------|--------------|
| HEADER NUMBER:             |                 | 42312-0036         |      |                 |              |
| PIN NUMBER:                |                 | 42663-ABA154       |      |                 |              |
| PIN LENGTH: L              |                 | .455 / 11.56       |      |                 |              |
| MATING LENGTH: M           |                 | .240 / 6.09        |      |                 |              |
| GOLD POINT: G              |                 | N/A                |      |                 |              |
| PC TAIL LENGTH: P          |                 | .125 / 3.18        |      |                 |              |
| TIN: T                     |                 | OVERALL            |      |                 |              |
| CKTS:                      |                 | 2-36               |      |                 |              |
| KINKS:                     |                 | NO                 |      |                 |              |
| VOIDED CKTS:               |                 | NONE               |      |                 |              |
| PACKAGING:                 |                 | BULK PK-40873-0041 |      |                 |              |
| CKTS                       | MATERIAL NUMBER | ENG NUMBER         | CKTS | MATERIAL NUMBER | ENG MATERIAL |
| 2                          | 22-28-4020      | A-42375-0002       | 20   | 22-28-4200      | 22-28-4200   |
| 3                          | 22-28-4030      | A-42375-0003       | 21   | 22-28-4210      | 22-28-4210   |
| 4                          | 22-28-4040      | A-42375-0004       | 22   | 22-28-4220      | 22-28-4220   |
| 5                          | 22-28-4050      | A-42375-0005       | 23   | 22-28-4230      | 22-28-4230   |
| 6                          | 22-28-4060      | A-42375-0006       | 24   | 22-28-4240      | 22-28-4240   |
| 7                          | 22-28-4070      | A-42375-0007       | 25   | 22-28-4250      | 22-28-4250   |
| 8                          | 22-28-4080      | A-42375-0008       | 26   | 22-28-4260      | 22-28-4260   |
| 9                          | 22-28-4090      | A-42375-0009       | 27   | 22-28-4270      | 22-28-4270   |
| 10                         | 22-28-4100      | A-42375-0010       | 28   | 22-28-4280      | 22-28-4280   |
| 11                         | 22-28-4110      | A-42375-0011       | 29   | 22-28-4290      | 22-28-4290   |
| 12                         | 22-28-4120      | A-42375-0012       | 30   | 22-28-4300      | 22-28-4300   |
| 13                         | 22-28-4130      | A-42375-0013       | 31   | 22-28-4310      | 22-28-4310   |
| 14                         | 22-28-4140      | A-42375-0014       | 32   | 22-28-4320      | 22-28-4320   |
| 15                         | 22-28-4150      | A-42375-0015       | 33   | 22-28-4330      | 22-28-4330   |
| 16                         | 22-28-4160      | A-42375-0016       | 34   | 22-28-4340      | 22-28-4340   |
| 17                         | 22-28-4170      | A-42375-0017       | 35   | 22-28-4350      | 22-28-4350   |
| 18                         | 22-28-4180      | A-42375-0018       | 36   | 22-28-4360      | 22-28-4360   |
| 19                         | 22-28-4190      | A-42375-0019       |      |                 |              |

| ENG. NO: A-42375-0037/0071 |                 |                                  |      |                 |              |
|----------------------------|-----------------|----------------------------------|------|-----------------|--------------|
| HEADER NUMBER:             |                 | 42312-0036                       |      |                 |              |
| PIN NUMBER:                |                 | 42663-ABB208                     |      |                 |              |
| PIN LENGTH: L              |                 | .455 / 11.56                     |      |                 |              |
| MATING LENGTH: M           |                 | .240 / 6.09                      |      |                 |              |
| GOLD POINT: G              |                 | .100 / 2.54 Min - 0.218/5.54 Max |      |                 |              |
| PC TAIL LENGTH: P          |                 | .125 / 3.18                      |      |                 |              |
| TIN: T                     |                 | .100 / 2.54                      |      |                 |              |
| CKTS:                      |                 | 2-36                             |      |                 |              |
| KINKS:                     |                 | NO                               |      |                 |              |
| VOIDED CKTS:               |                 | NONE                             |      |                 |              |
| PACKAGING:                 |                 | BULK PK-40873-0041               |      |                 |              |
| CKTS                       | MATERIAL NUMBER | ENG NUMBER                       | CKTS | MATERIAL NUMBER | ENG MATERIAL |
| 2                          | 22-28-4023      | A-42375-0037                     | 20   | 22-28-4203      | A-42375-0055 |
| 3                          | 22-28-4033      | A-42375-0038                     | 21   | 22-28-4213      | A-42375-0056 |
| 4                          | 22-28-4043      | A-42375-0039                     | 22   | 22-28-4223      | A-42375-0057 |
| 5                          | 22-28-4053      | A-42375-0040                     | 23   | 22-28-4233      | A-42375-0058 |
| 6                          | 22-28-4063      | A-42375-0041                     | 24   | 22-28-4243      | A-42375-0059 |
| 7                          | 22-28-4073      | A-42375-0042                     | 25   | 22-28-4253      | A-42375-0060 |
| 8                          | 22-28-4083      | A-42375-0043                     | 26   | 22-28-4263      | A-42375-0061 |
| 9                          | 22-28-4093      | A-42375-0044                     | 27   | 22-28-4273      | A-42375-0062 |
| 10                         | 22-28-4103      | A-42375-0045                     | 28   | 22-28-4283      | A-42375-0063 |
| 11                         | 22-28-4113      | A-42375-0046                     | 29   | 22-28-4293      | A-42375-0064 |
| 12                         | 22-28-4123      | A-42375-0047                     | 30   | 22-28-4303      | A-42375-0065 |
| 13                         | 22-28-4133      | A-42375-0048                     | 31   | 22-28-4313      | A-42375-0066 |
| 14                         | 22-28-4143      | A-42375-0049                     | 32   | 22-28-4323      | A-42375-0067 |
| 15                         | 22-28-4153      | A-42375-0050                     | 33   | 22-28-4333      | A-42375-0068 |
| 16                         | 22-28-4163      | A-42375-0051                     | 34   | 22-28-4343      | A-42375-0069 |
| 17                         | 22-28-4173      | A-42375-0052                     | 35   | 22-28-4353      | A-42375-0070 |
| 18                         | 22-28-4183      | A-42375-0053                     | 36   | 22-28-4363      | A-42375-0071 |
| 19                         | 22-28-4193      | A-42375-0054                     |      |                 |              |

|   |   |  |   |   |
|---|---|--|---|---|
| <b>SYMBOLS</b><br>= 0<br>= 0<br>= 0<br>= 0<br>= 0<br>= 0<br>= 0<br>= 0<br>= 0 | THIS DRAWING CONTAINS INFORMATION THAT IS PROPRIETARY TO MOLEX ELECTRONIC TECHNOLOGIES, LLC AND SHOULD NOT BE USED WITHOUT WRITTEN PERMISSION<br>DIMENSION UNITS: <b>MM/IN</b><br>SCALE: <b>1:1</b> | CURRENT REV DESC: GOLD LENGTH SPEC<br>CHANGED AS MIN 2.54- MAX 5.54 FOR<br>A-42375-0037/0071<br>EC NO: 689596<br>DRWN: SHRUTJ 2021/09/14<br>CHK'D: SHRUTJ 2021/12/20<br>APPR: ISHWARG 2021/12/20 | <br>KK 100 HEADER ASSY<br>FLAT VERTICAL BREAKAWAY<br>PRODUCT CUSTOMER DRAWING |   |
|   | GENERAL TOLERANCES<br>(UNLESS SPECIFIED)  | INITIAL REVISION:<br>DRWN: SCHAFFER 2003/02/11<br>APPR: MARGULIS 2004/02/27  |   | DOCUMENT NUMBER: <b>SD-42375-001</b><br>DOC TYPE: PSD<br>DOC PART: 001<br>REVISION: V   |
|   | 4 PLACES ±<br>3 PLACES ± 0.01<br>2 PLACES ± 0.25<br>1 PLACE ± 0.38<br>0 PLACES ±  | ANGULAR TOL ± 0.5°<br>DRAFT WHERE APPLICABLE<br>MUST REMAIN<br>WITHIN DIMENSIONS   |   | THIRD ANGLE PROJECTION<br>DRAWING: B-SIZE<br>SERIES: 42375<br>MATERIAL NUMBER: SEE CHART<br>CUSTOMER: GENERAL MARKET<br>SHEET NUMBER: 2 OF 35 |
|   |   |  |   |   |



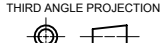





| ENG. NO: A-42375-0072/0106 |                 |                    |      |                 |              |
|----------------------------|-----------------|--------------------|------|-----------------|--------------|
| HEADER NUMBER:             |                 | 42312-0036         |      |                 |              |
| PIN NUMBER:                |                 | 42663-ABB228       |      |                 |              |
| PIN LENGTH: L              |                 | .455 / 11.56       |      |                 |              |
| MATING LENGTH: M           |                 | .240 / 6.09        |      |                 |              |
| GOLD POINT: G              |                 | .100 / 2.54        |      |                 |              |
| PC TAIL LENGTH: P          |                 | .125 / 3.18        |      |                 |              |
| TIN: T                     |                 | .100 / 2.54        |      |                 |              |
| CKTS:                      |                 | 2-36               |      |                 |              |
| KINKS:                     |                 | NO                 |      |                 |              |
| VOIDED CKTS:               |                 | NONE               |      |                 |              |
| PACKAGING:                 |                 | BULK PK-40873-0041 |      |                 |              |
| CKTS                       | MATERIAL NUMBER | ENG NUMBER         | CKTS | MATERIAL NUMBER | ENG NUMBER   |
| 2                          | 22-28-4026      | A-42375-0072       | 20   | 22-28-4206      | A-42375-0090 |
| 3                          | 22-28-4036      | A-42375-0073       | 21   | 22-28-4216      | A-42375-0091 |
| 4                          | 22-28-4046      | A-42375-0074       | 22   | 22-28-4226      | A-42375-0092 |
| 5                          | 22-28-4056      | A-42375-0075       | 23   | 22-28-4236      | A-42375-0093 |
| 6                          | 22-28-4066      | A-42375-0076       | 24   | 22-28-4246      | A-42375-0094 |
| 7                          | 22-28-4076      | A-42375-0077       | 25   | 22-28-4256      | A-42375-0095 |
| 8                          | 22-28-4086      | A-42375-0078       | 26   | 22-28-4266      | A-42375-0096 |
| 9                          | 22-28-4096      | A-42375-0079       | 27   | 22-28-4276      | A-42375-0097 |
| 10                         | 22-28-4106      | A-42375-0080       | 28   | 22-28-4286      | A-42375-0098 |
| 11                         | 22-28-4116      | A-42375-0081       | 29   | 22-28-4296      | A-42375-0099 |
| 12                         | 22-28-4126      | A-42375-0082       | 30   | 22-28-4306      | A-42375-0100 |
| 13                         | 22-28-4136      | A-42375-0083       | 31   | 22-28-4316      | A-42375-0101 |
| 14                         | 22-28-4146      | A-42375-0084       | 32   | 22-28-4326      | A-42375-0102 |
| 15                         | 22-28-4156      | A-42375-0085       | 33   | 22-28-4336      | A-42375-0103 |
| 16                         | 22-28-4166      | A-42375-0086       | 34   | 22-28-4346      | A-42375-0104 |
| 17                         | 22-28-4176      | A-42375-0087       | 35   | 22-28-4356      | A-42375-0105 |
| 18                         | 22-28-4186      | A-42375-0088       | 36   | 22-28-4366      | A-42375-0106 |
| 19                         | 22-28-4196      | A-42375-0089       |      |                 |              |

| ENG. NO: A-42375-0107/0141 |                 |                    |      |                 |              |
|----------------------------|-----------------|--------------------|------|-----------------|--------------|
| HEADER NUMBER:             |                 | 42312-0036         |      |                 |              |
| PIN NUMBER:                |                 | 42663-ATA154       |      |                 |              |
| PIN LENGTH: L              |                 | .530 / 13.46       |      |                 |              |
| MATING LENGTH: M           |                 | .320 / 8.13        |      |                 |              |
| GOLD POINT: G              |                 | N/A                |      |                 |              |
| PC TAIL LENGTH: P          |                 | .120 / 3.05        |      |                 |              |
| TIN: T                     |                 | .120 / 3.05        |      |                 |              |
| CKTS:                      |                 | 2-36               |      |                 |              |
| KINKS:                     |                 | NO                 |      |                 |              |
| VOIDED CKTS:               |                 | NONE               |      |                 |              |
| PACKAGING:                 |                 | BULK PK-40873-0041 |      |                 |              |
| CKTS                       | MATERIAL NUMBER | ENG NUMBER         | CKTS | MATERIAL NUMBER | ENG NUMBER   |
| 2                          | 22-28-4021      | A-42375-0107       | 20   | 22-28-4201      | A-42375-0125 |
| 3                          | 22-28-4031      | A-42375-0108       | 21   | 22-28-4211      | A-42375-0126 |
| 4                          | 22-28-4041      | A-42375-0109       | 22   | 22-28-4221      | A-42375-0127 |
| 5                          | 22-28-4051      | A-42375-0110       | 23   | 22-28-4231      | A-42375-0128 |
| 6                          | 22-28-4061      | A-42375-0111       | 24   | 22-28-4241      | A-42375-0129 |
| 7                          | 22-28-4071      | A-42375-0112       | 25   | 22-28-4251      | A-42375-0130 |
| 8                          | 22-28-4081      | A-42375-0113       | 26   | 22-28-4261      | A-42375-0131 |
| 9                          | 22-28-4091      | A-42375-0114       | 27   | 22-28-4271      | A-42375-0132 |
| 10                         | 22-28-4101      | A-42375-0115       | 28   | 22-28-4281      | A-42375-0133 |
| 11                         | 22-28-4111      | A-42375-0116       | 29   | 22-28-4291      | A-42375-0134 |
| 12                         | 22-28-4121      | A-42375-0117       | 30   | 22-28-4301      | A-42375-0135 |
| 13                         | 22-28-4131      | A-42375-0118       | 31   | 22-28-4311      | A-42375-0136 |
| 14                         | 22-28-4141      | A-42375-0119       | 32   | 22-28-4321      | A-42375-0137 |
| 15                         | 22-28-4151      | A-42375-0120       | 33   | 22-28-4331      | A-42375-0138 |
| 16                         | 22-28-4161      | A-42375-0121       | 34   | 22-28-4341      | A-42375-0139 |
| 17                         | 22-28-4171      | A-42375-0122       | 35   | 22-28-4351      | A-42375-0140 |
| 18                         | 22-28-4181      | A-42375-0123       | 36   | 22-28-4361      | A-42375-0141 |
| 19                         | 22-28-4191      | A-42375-0124       |      |                 |              |

| <b>SYMBOLS</b><br> = 0<br> = 0<br> = 0<br> = 0<br> = 0<br> = 0<br> = 0 | THIS DRAWING CONTAINS INFORMATION THAT IS PROPRIETARY TO MOLEX ELECTRONIC TECHNOLOGIES, LLC AND SHOULD NOT BE USED WITHOUT WRITTEN PERMISSION<br>DIMENSION UNITS: <b>MM/IN</b><br>SCALE: <b>1:1</b><br>CURRENT REV DESC: GOLD LENGTH SPEC CHANGED AS MIN 2.54- MAX 5.54 FOR A-42375-0037/0071<br>GENERAL TOLERANCES (UNLESS SPECIFIED)<br><table border="1"> <tr><th></th><th>MM</th><th>INCH</th></tr> <tr><td>4 PLACES</td><td>±</td><td>±</td></tr> <tr><td>3 PLACES</td><td>±</td><td>± 0.01</td></tr> <tr><td>2 PLACES</td><td>± 0.25</td><td>±</td></tr> <tr><td>1 PLACE</td><td>± 0.38</td><td>±</td></tr> <tr><td>0 PLACES</td><td>±</td><td>±</td></tr> </table> ANGULAR TOL ± 0.5°<br>DRAFT WHERE APPLICABLE MUST REMAIN WITHIN DIMENSIONS<br>THIRD ANGLE PROJECTION<br> |    | MM     | INCH | 4 PLACES | ± | ± | 3 PLACES | ± | ± 0.01 | 2 PLACES | ± 0.25 | ± | 1 PLACE | ± 0.38 | ± | 0 PLACES | ± | ± | EC NO: 689596<br>DRWN: SHRUTJ 2021/09/14<br>CHK'D: SHRUTJ 2021/12/20<br>APPR: ISHWARG 2021/12/20<br>INITIAL REVISION:<br>DRWN: SCHAFFER 2003/02/11<br>APPR: MARGULIS 2004/02/27 | <br>KK 100 HEADER ASSY<br>FLAT VERTICAL BREAKAWAY<br>PRODUCT CUSTOMER DRAWING<br>DOCUMENT NUMBER: <b>SD-42375-001</b><br>DOC TYPE: PSD<br>DOC PART: 001<br>REVISION: V<br>MATERIAL NUMBER: SEE CHART<br>CUSTOMER: GENERAL MARKET<br>SHEET NUMBER: 3 OF 35 |
|---|---|----|--------|------|----------|---|---|----------|---|--------|----------|--------|---|---------|--------|---|----------|---|---|---|--|
|   |   | MM | INCH   |      |          |   |   |          |   |        |          |        |   |         |        |   |          |   |   |   |  |
|   | 4 PLACES  | ±  | ±      |      |          |   |   |          |   |        |          |        |   |         |        |   |          |   |   |   |  |
|   | 3 PLACES  | ±  | ± 0.01 |      |          |   |   |          |   |        |          |        |   |         |        |   |          |   |   |   |  |
| 2 PLACES  | ± 0.25  | ±  |        |      |          |   |   |          |   |        |          |        |   |         |        |   |          |   |   |   |  |
| 1 PLACE   | ± 0.38  | ±  |        |      |          |   |   |          |   |        |          |        |   |         |        |   |          |   |   |   |  |
| 0 PLACES  | ±   | ±  |        |      |          |   |   |          |   |        |          |        |   |         |        |   |          |   |   |   |  |

| ENG. NO: A-42375-0142/0176 |                 |                    |      |                 |              |
|----------------------------|-----------------|--------------------|------|-----------------|--------------|
| HEADER NUMBER:             |                 | 42312-0036         |      |                 |              |
| PIN NUMBER:                |                 | 42663-ATB208       |      |                 |              |
| PIN LENGTH: L              |                 | .530 / 13.46       |      |                 |              |
| MATING LENGTH: M           |                 | 320 / 8.13         |      |                 |              |
| GOLD POINT: G              |                 | .140 / 3.56        |      |                 |              |
| PC TAIL LENGTH: P          |                 | .120 / 3.05        |      |                 |              |
| TIN: T                     |                 | .135 / 3.43        |      |                 |              |
| CKTS:                      |                 | 2-36               |      |                 |              |
| KINKS:                     |                 | NO                 |      |                 |              |
| VOIDED CKTS:               |                 | NONE               |      |                 |              |
| PACKAGING:                 |                 | BULK PK-40873-0041 |      |                 |              |
| CKTS                       | MATERIAL NUMBER | ENG NUMBER         | CKTS | MATERIAL NUMBER | ENG NUMBER   |
| 2                          | 22-28-4024      | A-42375-0142       | 20   | 22-28-4204      | A-42375-0160 |
| 3                          | 22-28-4035      | A-42375-0143       | 21   | 22-28-4214      | A-42375-0161 |
| 4                          | 22-28-4044      | A-42375-0144       | 22   | 22-28-4224      | A-42375-0162 |
| 5                          | 22-28-4054      | A-42375-0145       | 23   | 22-28-4234      | A-42375-0163 |
| 6                          | 22-28-4064      | A-42375-0146       | 24   | 22-28-4244      | A-42375-0164 |
| 7                          | 22-28-4074      | A-42375-0147       | 25   | 22-28-4254      | A-42375-0165 |
| 8                          | 22-28-4084      | A-42375-0148       | 26   | 22-28-4264      | A-42375-0166 |
| 9                          | 22-28-4094      | A-42375-0149       | 27   | 22-28-4274      | A-42375-0167 |
| 10                         | 22-28-4104      | A-42375-0150       | 28   | 22-28-4284      | A-42375-0168 |
| 11                         | 22-28-4114      | A-42375-0151       | 29   | 22-28-4294      | A-42375-0169 |
| 12                         | 22-28-4124      | A-42375-0152       | 30   | 22-28-4304      | A-42375-0170 |
| 13                         | 22-28-4134      | A-42375-0153       | 31   | 22-28-4314      | A-42375-0171 |
| 14                         | 22-28-4144      | A-42375-0154       | 32   | 22-28-4324      | A-42375-0172 |
| 15                         | 22-28-4154      | A-42375-0155       | 33   | 22-28-4334      | A-42375-0173 |
| 16                         | 22-28-4164      | A-42375-0156       | 34   | 22-28-4344      | A-42375-0174 |
| 17                         | 22-28-4174      | A-42375-0157       | 35   | 22-28-4354      | A-42375-0175 |
| 18                         | 22-28-4184      | A-42375-0158       | 36   | 22-28-4364      | A-42375-0176 |
| 19                         | 22-28-4194      | A-42375-0159       |      |                 |              |

| ENG. NO: A-42375-0177/0211 |                 |                    |      |                 |              |
|----------------------------|-----------------|--------------------|------|-----------------|--------------|
| HEADER NUMBER:             |                 | 42312-0036         |      |                 |              |
| PIN NUMBER:                |                 | 42663-ATB208       |      |                 |              |
| PIN LENGTH: L              |                 | .530 / 13.46       |      |                 |              |
| MATING LENGTH: M           |                 | 320 / 8.13         |      |                 |              |
| GOLD POINT: G              |                 | .140 / 3.56        |      |                 |              |
| PC TAIL LENGTH: P          |                 | .120 / 3.05        |      |                 |              |
| TIN: T                     |                 | .135 / 3.43        |      |                 |              |
| CKTS:                      |                 | 2-36               |      |                 |              |
| KINKS:                     |                 | NO                 |      |                 |              |
| VOIDED CKTS:               |                 | NONE               |      |                 |              |
| PACKAGING:                 |                 | BULK PK-40873-0041 |      |                 |              |
| CKTS                       | MATERIAL NUMBER | ENG NUMBER         | CKTS | MATERIAL NUMBER | ENG NUMBER   |
| 2                          | 22-28-4027      | A-42375-0177       | 20   | 22-28-4207      | A-42375-0195 |
| 3                          | 22-28-4037      | A-42375-0178       | 21   | 22-28-4217      | A-42375-0196 |
| 4                          | 22-28-4047      | A-42375-0179       | 22   | 22-28-4227      | A-42375-0197 |
| 5                          | 22-28-4057      | A-42375-0180       | 23   | 22-28-4237      | A-42375-0198 |
| 6                          | 22-28-4067      | A-42375-0181       | 24   | 22-28-4247      | A-42375-0199 |
| 7                          | 22-28-4077      | A-42375-0182       | 25   | 22-28-4257      | A-42375-0200 |
| 8                          | 22-28-4087      | A-42375-0183       | 26   | 22-28-4267      | A-42375-0201 |
| 9                          | 22-28-4097      | A-42375-0184       | 27   | 22-28-4277      | A-42375-0202 |
| 10                         | 22-28-4107      | A-42375-0185       | 28   | 22-28-4287      | A-42375-0203 |
| 11                         | 22-28-4117      | A-42375-0186       | 29   | 22-28-4297      | A-42375-0204 |
| 12                         | 22-28-4127      | A-42375-0187       | 30   | 22-28-4307      | A-42375-0205 |
| 13                         | 22-28-4137      | A-42375-0188       | 31   | 22-28-4317      | A-42375-0206 |
| 14                         | 22-28-4147      | A-42375-0189       | 32   | 22-28-4327      | A-42375-0207 |
| 15                         | 22-28-4157      | A-42375-0190       | 33   | 22-28-4337      | A-42375-0208 |
| 16                         | 22-28-4167      | A-42375-0191       | 34   | 22-28-4347      | A-42375-0209 |
| 17                         | 22-28-4177      | A-42375-0192       | 35   | 22-28-4357      | A-42375-0210 |
| 18                         | 22-28-4187      | A-42375-0193       | 36   | 22-28-4367      | A-42375-0211 |
| 19                         | 22-28-4197      | A-42375-0194       |      |                 |              |

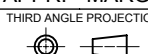
|  |  |   |  |  |
|--|--|---|--|--|
| <b>SYMBOLS</b><br> = 0<br> = 0<br> = 0<br> = 0<br> = 0<br> = 0<br> = 0<br> = 0 | DIMENSION UNITS<br><b>MM/IN</b>  | SCALE<br><b>1:1</b>   | CURRENT REV DESC: GOLD LENGTH SPEC<br>CHANGED AS MIN 2.54- MAX 5.54 FOR<br>A-42375-0037/0071     | <br><br>KK 100 HEADER ASSY<br>FLAT VERTICAL BREAKAWAY<br><br>PRODUCT CUSTOMER DRAWING |
|  | GENERAL TOLERANCES<br>(UNLESS SPECIFIED)   |   | EC NO: 689596<br>DRWN: SHRUTJ 2021/09/14<br>CHK'D: SHRUTJ 2021/12/20<br>APPR: ISHWARG 2021/12/20 |  |
|  | 4 PLACES ±<br>3 PLACES ±<br>2 PLACES ± 0.25 ±<br>1 PLACE ± 0.38 ±<br>0 PLACES ±  | MM<br>INCH  | INITIAL REVISION:<br>DRWN: SCHAFFER 2003/02/11<br>APPR: MARGULIS 2004/02/27                      |  |
|  | ANGULAR TOL ± 0.5°<br>DRAFT WHERE APPLICABLE<br>MUST REMAIN<br>WITHIN DIMENSIONS | THIRD ANGLE PROJECTION<br> | DRAWING SERIES<br><b>B-SIZE 42375</b>  |  |
| DOCUMENT STATUS   P1   RELEASE DATE   2021/12/20 12:18:33  | DOCUMENT NUMBER<br><b>SD-42375-001</b>   | DOC TYPE   DOC PART   REVISION<br>PSD   001   V   | MATERIAL NUMBER   CUSTOMER   SHEET NUMBER<br>SEE CHART   GENERAL MARKET   4 OF 35                |  |

| ENG. NO: A-42375-0212/0246 |                 |                    |      |                 |              |
|----------------------------|-----------------|--------------------|------|-----------------|--------------|
| HEADER NUMBER:             |                 | 42312-0036         |      |                 |              |
| PIN NUMBER:                |                 | 42663-AMA154       |      |                 |              |
| PIN LENGTH: L              |                 | .505 / 12.83       |      |                 |              |
| MATING LENGTH: M           |                 | .295 / 7.49        |      |                 |              |
| GOLD POINT: G              |                 | N/A                |      |                 |              |
| PC TAIL LENGTH: P          |                 | .120 / 3.05        |      |                 |              |
| TIN: T                     |                 | OVERALL            |      |                 |              |
| CKTS:                      |                 | 2-36               |      |                 |              |
| KINKS:                     |                 | NO                 |      |                 |              |
| VOIDED CKTS:               |                 | NONE               |      |                 |              |
| PACKAGING:                 |                 | BULK PK-40873-0041 |      |                 |              |
| CKTS                       | MATERIAL NUMBER | ENG NUMBER         | CKTS | MATERIAL NUMBER | ENG NUMBER   |
| 2                          | 22-28-4022      | A-42375-0212       | 20   | 22-28-4202      | A-42375-0230 |
| 3                          | 22-28-4032      | A-42375-0213       | 21   | 22-28-4212      | A-42375-0231 |
| 4                          | 22-28-4042      | A-42375-0214       | 22   | 22-28-4222      | A-42375-0232 |
| 5                          | 22-28-4052      | A-42375-0215       | 23   | 22-28-4232      | A-42375-0233 |
| 6                          | 22-28-4062      | A-42375-0216       | 24   | 22-28-4242      | A-42375-0234 |
| 7                          | 22-28-4072      | A-42375-0217       | 25   | 22-28-4252      | A-42375-0235 |
| 8                          | 22-28-4082      | A-42375-0218       | 26   | 22-28-4262      | A-42375-0236 |
| 9                          | 22-28-4092      | A-42375-0219       | 27   | 22-28-4272      | A-42375-0237 |
| 10                         | 22-28-4102      | A-42375-0220       | 28   | 22-28-4282      | A-42375-0238 |
| 11                         | 22-28-4112      | A-42375-0221       | 29   | 22-28-4292      | A-42375-0239 |
| 12                         | 22-28-4122      | A-42375-0222       | 30   | 22-28-4302      | A-42375-0240 |
| 13                         | 22-28-4132      | A-42375-0223       | 31   | 22-28-4312      | A-42375-0241 |
| 14                         | 22-28-4142      | A-42375-0224       | 32   | 22-28-4322      | A-42375-0242 |
| 15                         | 22-28-4152      | A-42375-0225       | 33   | 22-28-4332      | A-42375-0243 |
| 16                         | 22-28-4162      | A-42375-0226       | 34   | 22-28-4342      | A-42375-0244 |
| 17                         | 22-28-4172      | A-42375-0227       | 35   | 22-28-4352      | A-42375-0245 |
| 18                         | 22-28-4182      | A-42375-0228       | 36   | 22-28-4362      | A-42375-0246 |
| 19                         | 22-28-4192      | A-42375-0229       |      |                 |              |

| ENG. NO: A-42375-0247/0281 |                 |                    |      |                 |              |
|----------------------------|-----------------|--------------------|------|-----------------|--------------|
| HEADER NUMBER:             |                 | 42312-0036         |      |                 |              |
| PIN NUMBER:                |                 | 42663-ATB208       |      |                 |              |
| PIN LENGTH: L              |                 | .505 / 12.83       |      |                 |              |
| MATING LENGTH: M           |                 | .295 / 7.49        |      |                 |              |
| GOLD POINT: G              |                 | .140 / 3.56        |      |                 |              |
| PC TAIL LENGTH: P          |                 | .120 / 3.05        |      |                 |              |
| TIN: T                     |                 | .135 / 3.43        |      |                 |              |
| CKTS:                      |                 | 2-36               |      |                 |              |
| KINKS:                     |                 | NO                 |      |                 |              |
| VOIDED CKTS:               |                 | NONE               |      |                 |              |
| PACKAGING:                 |                 | BULK PK-40873-0041 |      |                 |              |
| CKTS                       | MATERIAL NUMBER | ENG NUMBER         | CKTS | MATERIAL NUMBER | ENG NUMBER   |
| 2                          | 22-28-4025      | A-42375-0247       | 20   | 22-28-4205      | A-42375-0265 |
| 3                          | 22-28-4035      | A-42375-0248       | 21   | 22-28-4215      | A-42375-0266 |
| 4                          | 22-28-4045      | A-42375-0249       | 22   | 22-28-4225      | A-42375-0267 |
| 5                          | 22-28-4055      | A-42375-0250       | 23   | 22-28-4235      | A-42375-0268 |
| 6                          | 22-28-4065      | A-42375-0251       | 24   | 22-28-4245      | A-42375-0269 |
| 7                          | 22-28-4075      | A-42375-0252       | 25   | 22-28-4255      | A-42375-0270 |
| 8                          | 22-28-4085      | A-42375-0253       | 26   | 22-28-4265      | A-42375-0271 |
| 9                          | 22-28-4095      | A-42375-0254       | 27   | 22-28-4275      | A-42375-0272 |
| 10                         | 22-28-4105      | A-42375-0255       | 28   | 22-28-4285      | A-42375-0273 |
| 11                         | 22-28-4115      | A-42375-0256       | 29   | 22-28-4295      | A-42375-0274 |
| 12                         | 22-28-4125      | A-42375-0257       | 30   | 22-28-4305      | A-42375-0275 |
| 13                         | 22-28-4135      | A-42375-0258       | 31   | 22-28-4315      | A-42375-0276 |
| 14                         | 22-28-4145      | A-42375-0259       | 32   | 22-28-4325      | A-42375-0277 |
| 15                         | 22-28-4155      | A-42375-0260       | 33   | 22-28-4335      | A-42375-0278 |
| 16                         | 22-28-4165      | A-42375-0261       | 34   | 22-28-4345      | A-42375-0279 |
| 17                         | 22-28-4175      | A-42375-0262       | 35   | 22-28-4355      | A-42375-0280 |
| 18                         | 22-28-4185      | A-42375-0263       | 36   | 22-28-4365      | A-42375-0281 |
| 19                         | 22-28-4195      | A-42375-0264       |      |                 |              |

|   |   |  |   |
|---|---|--|---|
| <b>SYMBOLS</b><br>= 0<br>= 0<br>= 0<br>= 0<br>= 0<br>= 0<br>= 0<br>= 0<br>= 0 | THIS DRAWING CONTAINS INFORMATION THAT IS PROPRIETARY TO MOLEX ELECTRONIC TECHNOLOGIES, LLC AND SHOULD NOT BE USED WITHOUT WRITTEN PERMISSION<br>DIMENSION UNITS: <b>MM/IN</b><br>SCALE: <b>1:1</b> | CURRENT REV DESC: GOLD LENGTH SPEC<br>CHANGED AS MIN 2.54- MAX 5.54 FOR<br>A-42375-0037/0071     | <br><br>KK 100 HEADER ASSY<br>FLAT VERTICAL BREAKAWAY<br><br>PRODUCT CUSTOMER DRAWING |
|   | GENERAL TOLERANCES<br>(UNLESS SPECIFIED)  | EC NO: 689596<br>DRWN: SHRUTJ 2021/09/14<br>CHK'D: SHRUTJ 2021/12/20<br>APPR: ISHWARG 2021/12/20 |   |
|   | 4 PLACES ±<br>3 PLACES ± 0.01<br>2 PLACES ± 0.25<br>1 PLACE ± 0.38<br>0 PLACES ±  | INITIAL REVISION:<br>DRWN: SCHAFFER 2003/02/11<br>APPR: MARGULIS 2004/02/27                      |   |
|   | ANGULAR TOL ± 0.5°<br>DRAFT WHERE APPLICABLE<br>MUST REMAIN<br>WITHIN DIMENSIONS  | THIRD ANGLE PROJECTION<br><br>DRAWING: <b>B-SIZE</b><br>SERIES: <b>42375</b>                     |   |
| DOCUMENT STATUS   P1   RELEASE DATE   2021/12/20 12:18:33                     | DOCUMENT NUMBER: <b>SD-42375-001</b><br>DOC TYPE: PSD   DOC PART: 001   REVISION: V   |  | MATERIAL NUMBER: SEE CHART<br>CUSTOMER: GENERAL MARKET<br>SHEET NUMBER: 5 OF 35       |









| ENG. NO: A-42375-0282/0316 |                 |                    |      |                 |              |
|----------------------------|-----------------|--------------------|------|-----------------|--------------|
| HEADER NUMBER:             |                 | 42312-0036         |      |                 |              |
| PIN NUMBER:                |                 | 42663-AMB228       |      |                 |              |
| PIN LENGTH: L              |                 | .505 / 12.83       |      |                 |              |
| MATING LENGTH: M           |                 | .295 / 7.49        |      |                 |              |
| GOLD POINT: G              |                 | .140 / 3.56        |      |                 |              |
| PC TAIL LENGTH: P          |                 | .120 / 3.05        |      |                 |              |
| TIN: T                     |                 | .135 / 3.43        |      |                 |              |
| CKTS:                      |                 | 2-36               |      |                 |              |
| KINKS:                     |                 | NO                 |      |                 |              |
| VOIDED CKTS:               |                 | NONE               |      |                 |              |
| PACKAGING:                 |                 | BULK PK-40873-0041 |      |                 |              |
| CKTS                       | MATERIAL NUMBER | ENG NUMBER         | CKTS | MATERIAL NUMBER | ENG NUMBER   |
| 2                          | 22-28-4028      | A-42375-0282       | 20   | 22-28-4208      | A-42375-0300 |
| 3                          | 22-28-4038      | A-42375-0283       | 21   | 22-28-4218      | A-42375-0301 |
| 4                          | 22-28-4048      | A-42375-0284       | 22   | 22-28-4228      | A-42375-0302 |
| 5                          | 22-28-4058      | A-42375-0285       | 23   | 22-28-4238      | A-42375-0303 |
| 6                          | 22-28-4068      | A-42375-0286       | 24   | 22-28-4248      | A-42375-0304 |
| 7                          | 22-28-4078      | A-42375-0287       | 25   | 22-28-4258      | A-42375-0305 |
| 8                          | 22-28-4088      | A-42375-0288       | 26   | 22-28-4268      | A-42375-0306 |
| 9                          | 22-28-4098      | A-42375-0289       | 27   | 22-28-4278      | A-42375-0307 |
| 10                         | 22-28-4108      | A-42375-0290       | 28   | 22-28-4288      | A-42375-0308 |
| 11                         | 22-28-4118      | A-42375-0291       | 29   | 22-28-4298      | A-42375-0309 |
| 12                         | 22-28-4128      | A-42375-0292       | 30   | 22-28-4308      | A-42375-0310 |
| 13                         | 22-28-4138      | A-42375-0293       | 31   | 22-28-4318      | A-42375-0311 |
| 14                         | 22-28-4148      | A-42375-0294       | 32   | 22-28-4328      | A-42375-0312 |
| 15                         | 22-28-4158      | A-42375-0295       | 33   | 22-28-4338      | A-42375-0313 |
| 16                         | 22-28-4168      | A-42375-0296       | 34   | 22-28-4348      | A-42375-0314 |
| 17                         | 22-28-4178      | A-42375-0297       | 35   | 22-28-4358      | A-42375-0315 |
| 18                         | 22-28-4188      | A-42375-0298       | 36   | 22-28-4368      | A-42375-0316 |
| 19                         | 22-28-4198      | A-42375-0299       |      |                 |              |

| ENG. NO: A-42375-0317/0351 |                 |                    |      |                 |              |
|----------------------------|-----------------|--------------------|------|-----------------|--------------|
| HEADER NUMBER:             |                 | 42312-0036         |      |                 |              |
| PIN NUMBER:                |                 | 42663-ADA154       |      |                 |              |
| PIN LENGTH: L              |                 | .465 / 11.81       |      |                 |              |
| MATING LENGTH: M           |                 | .240 / 6.09        |      |                 |              |
| GOLD POINT: G              |                 | N/A                |      |                 |              |
| PC TAIL LENGTH: P          |                 | .135 / 3.43        |      |                 |              |
| TIN: T                     |                 | OVERALL            |      |                 |              |
| CKTS:                      |                 | 2-36               |      |                 |              |
| KINKS:                     |                 | SMES-42003         |      |                 |              |
| VOIDED CKTS:               |                 | NONE               |      |                 |              |
| PACKAGING:                 |                 | BULK PK-40873-0041 |      |                 |              |
| CKTS                       | MATERIAL NUMBER | ENG NUMBER         | CKTS | MATERIAL NUMBER | ENG NUMBER   |
| 2                          | 22-28-5020      | A-42375-0317       | 20   | 22-28-5200      | A-42375-0335 |
| 3                          | 22-28-5030      | A-42375-0318       | 21   | 22-28-5201      | A-42375-0336 |
| 4                          | 22-28-5040      | A-42375-0319       | 22   | 22-28-5202      | A-42375-0337 |
| 5                          | 22-28-5050      | A-42375-0320       | 23   | 22-28-5203      | A-42375-0338 |
| 6                          | 22-28-5060      | A-42375-0321       | 24   | 22-28-5204      | A-42375-0339 |
| 7                          | 22-28-5070      | A-42375-0322       | 25   | 22-28-5205      | A-42375-0340 |
| 8                          | 22-28-5080      | A-42375-0323       | 26   | 22-28-5206      | A-42375-0341 |
| 9                          | 22-28-5090      | A-42375-0324       | 27   | 22-28-5207      | A-42375-0342 |
| 10                         | 22-28-5100      | A-42375-0325       | 28   | 22-28-5208      | A-42375-0343 |
| 11                         | 22-28-5110      | A-42375-0326       | 29   | 22-28-5209      | A-42375-0344 |
| 12                         | 22-28-5120      | A-42375-0327       | 30   | 22-28-5300      | A-42375-0345 |
| 13                         | 22-28-5130      | A-42375-0328       | 31   | 22-28-5310      | A-42375-0346 |
| 14                         | 22-28-5140      | A-42375-0329       | 32   | 22-28-5320      | A-42375-0347 |
| 15                         | 22-28-5150      | A-42375-0330       | 33   | 22-28-5330      | A-42375-0348 |
| 16                         | 22-28-5160      | A-42375-0331       | 34   | 22-28-5340      | A-42375-0349 |
| 17                         | 22-28-5170      | A-42375-0332       | 35   | 22-28-5350      | A-42375-0350 |
| 18                         | 22-28-5180      | A-42375-0333       | 36   | 22-28-5360      | A-42375-0351 |
| 19                         | 22-28-5190      | A-42375-0334       |      |                 |              |

|  |  |   |   |  |  |
|--|--|---|---|--|--|
| <b>SYMBOLS</b><br> = 0<br> = 0<br> = 0<br> = 0<br> = 0<br> = 0<br> = 0<br> = 0 | THIS DRAWING CONTAINS INFORMATION THAT IS PROPRIETARY TO MOLEX ELECTRONIC TECHNOLOGIES, LLC AND SHOULD NOT BE USED WITHOUT WRITTEN PERMISSION<br>DIMENSION UNITS: <b>MM/IN</b> SCALE: <b>1:1</b> |   | CURRENT REV DESC: GOLD LENGTH SPEC<br>CHANGED AS MIN 2.54- MAX 5.54 FOR<br>A-42375-0037/0071                    |  | <br><br>KK 100 HEADER ASSY<br>FLAT VERTICAL BREAKAWAY<br><br>PRODUCT CUSTOMER DRAWING |
|  | GENERAL TOLERANCES<br>(UNLESS SPECIFIED)   |   | EC NO: 689596<br>DRWN: SHRUTJ      2021/09/14<br>CHK'D: SHRUTJ      2021/12/20<br>APPR: ISHWARG      2021/12/20 |  |  |
|  | 4 PLACES ±      ±<br>3 PLACES ±      ± 0.01<br>2 PLACES ± 0.25 ±<br>1 PLACE ± 0.38 ±<br>0 PLACES ±      ±  |   | INITIAL REVISION:<br>DRWN: SCHAFFER      2003/02/11<br>APPR: MARGULIS      2004/02/27                           |  |  |
|  | ANGULAR TOL ± 0.5°<br>DRAFT WHERE APPLICABLE<br>MUST REMAIN<br>WITHIN DIMENSIONS   |   | THIRD ANGLE PROJECTION<br> |  |  |
| DOCUMENT STATUS   P1   RELEASE DATE   2021/12/20 12:18:33  |  | DRWG: SCHAFFER      2003/02/11<br>APPR: MARGULIS      2004/02/27                |   | DOCUMENT NUMBER: <b>SD-42375-001</b> DOC TYPE: PSD      DOC PART: 001      REVISION: V |  |
|  |  | MATERIAL NUMBER: 42375      CUSTOMER: GENERAL MARKET      SHEET NUMBER: 6 OF 35 |   | SEE CHART  |  |





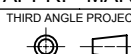



| ENG. NO: A-42375-0352/0386 |                 |                    |      |                 |              |
|----------------------------|-----------------|--------------------|------|-----------------|--------------|
| HEADER NUMBER:             |                 | 42312-0036         |      |                 |              |
| PIN NUMBER:                |                 | 42663-ADB208       |      |                 |              |
| PIN LENGTH: L              |                 | .465 / 11.81       |      |                 |              |
| MATING LENGTH: M           |                 | .240 / 6.09        |      |                 |              |
| GOLD POINT: G              |                 | .100 / 2.54        |      |                 |              |
| PC TAIL LENGTH: P          |                 | .135 / 3.43        |      |                 |              |
| TIN: T                     |                 | .100 / 2.54        |      |                 |              |
| CKTS:                      |                 | 2-36               |      |                 |              |
| KINKS:                     |                 | SMES-42003         |      |                 |              |
| VOIDED CKTS:               |                 | NONE               |      |                 |              |
| PACKAGING:                 |                 | BULK PK-40873-0041 |      |                 |              |
| CKTS                       | MATERIAL NUMBER | ENG NUMBER         | CKTS | MATERIAL NUMBER | ENG NUMBER   |
| 2                          | 22-28-5023      | A-42375-0352       | 20   | 22-28-5203      | A-42375-0370 |
| 3                          | 22-28-5033      | A-42375-0353       | 21   | 22-28-5213      | A-42375-0371 |
| 4                          | 22-28-5043      | A-42375-0354       | 22   | 22-28-5223      | A-42375-0372 |
| 5                          | 22-28-5053      | A-42375-0355       | 23   | 22-28-5233      | A-42375-0373 |
| 6                          | 22-28-5063      | A-42375-0356       | 24   | 22-28-5243      | A-42375-0374 |
| 7                          | 22-28-5073      | A-42375-0357       | 25   | 22-28-5253      | A-42375-0375 |
| 8                          | 22-28-5083      | A-42375-0358       | 26   | 22-28-5263      | A-42375-0376 |
| 9                          | 22-28-5093      | A-42375-0359       | 27   | 22-28-5273      | A-42375-0377 |
| 10                         | 22-28-5103      | A-42375-0360       | 28   | 22-28-5283      | A-42375-0378 |
| 11                         | 22-28-5113      | A-42375-0361       | 29   | 22-28-5293      | A-42375-0379 |
| 12                         | 22-28-5123      | A-42375-0362       | 30   | 22-28-5303      | A-42375-0380 |
| 13                         | 22-28-5133      | A-42375-0363       | 31   | 22-28-5313      | A-42375-0381 |
| 14                         | 22-28-5143      | A-42375-0364       | 32   | 22-28-5323      | A-42375-0382 |
| 15                         | 22-28-5153      | A-42375-0365       | 33   | 22-28-5333      | A-42375-0383 |
| 16                         | 22-28-5163      | A-42375-0366       | 34   | 22-28-5343      | A-42375-0384 |
| 17                         | 22-28-5173      | A-42375-0367       | 35   | 22-28-5353      | A-42375-0385 |
| 18                         | 22-28-5183      | A-42375-0368       | 36   | 22-28-5363      | A-42375-0386 |
| 19                         | 22-28-5193      | A-42375-0369       |      |                 |              |

| ENG. NO: A-42375-0387/0421 |                 |                    |      |                 |              |
|----------------------------|-----------------|--------------------|------|-----------------|--------------|
| HEADER NUMBER:             |                 | 42312-0036         |      |                 |              |
| PIN NUMBER:                |                 | 42663-ADB228       |      |                 |              |
| PIN LENGTH: L              |                 | .465 / 11.81       |      |                 |              |
| MATING LENGTH: M           |                 | .240 / 6.09        |      |                 |              |
| GOLD POINT: G              |                 | .100 / 2.54        |      |                 |              |
| PC TAIL LENGTH: P          |                 | .135 / 3.43        |      |                 |              |
| TIN: T                     |                 | .100 / 2.54        |      |                 |              |
| CKTS:                      |                 | 2-36               |      |                 |              |
| KINKS:                     |                 | SMES-42003         |      |                 |              |
| VOIDED CKTS:               |                 | NONE               |      |                 |              |
| PACKAGING:                 |                 | BULK PK-40873-0041 |      |                 |              |
| CKTS                       | MATERIAL NUMBER | ENG NUMBER         | CKTS | MATERIAL NUMBER | ENG NUMBER   |
| 2                          | 22-28-5026      | A-42375-0387       | 20   | 22-28-5206      | A-42375-0405 |
| 3                          | 22-28-5036      | A-42375-0388       | 21   | 22-28-5216      | A-42375-0406 |
| 4                          | 22-28-5046      | A-42375-0389       | 22   | 22-28-5226      | A-42375-0407 |
| 5                          | 22-28-5056      | A-42375-0390       | 23   | 22-28-5236      | A-42375-0408 |
| 6                          | 22-28-5066      | A-42375-0391       | 24   | 22-28-5246      | A-42375-0409 |
| 7                          | 22-28-5076      | A-42375-0392       | 25   | 22-28-5256      | A-42375-0410 |
| 8                          | 22-28-5086      | A-42375-0393       | 26   | 22-28-5266      | A-42375-0411 |
| 9                          | 22-28-5096      | A-42375-0394       | 27   | 22-28-5276      | A-42375-0412 |
| 10                         | 22-28-5106      | A-42375-0395       | 28   | 22-28-5286      | A-42375-0413 |
| 11                         | 22-28-5116      | A-42375-0396       | 29   | 22-28-5296      | A-42375-0414 |
| 12                         | 22-28-5126      | A-42375-0397       | 30   | 22-28-5306      | A-42375-0415 |
| 13                         | 22-28-5136      | A-42375-0398       | 31   | 22-28-5316      | A-42375-0416 |
| 14                         | 22-28-5146      | A-42375-0399       | 32   | 22-28-5326      | A-42375-0417 |
| 15                         | 22-28-5156      | A-42375-0400       | 33   | 22-28-5336      | A-42375-0418 |
| 16                         | 22-28-5166      | A-42375-0401       | 34   | 22-28-5346      | A-42375-0419 |
| 17                         | 22-28-5176      | A-42375-0402       | 35   | 22-28-5356      | A-42375-0420 |
| 18                         | 22-28-5186      | A-42375-0403       | 36   | 22-28-5366      | A-42375-0421 |
| 19                         | 22-28-5196      | A-42375-0404       |      |                 |              |

| <b>SYMBOLS</b><br> = 0<br> = 0<br> = 0<br> = 0<br> = 0<br> = 0<br> = 0<br> = 0 | THIS DRAWING CONTAINS INFORMATION THAT IS PROPRIETARY TO MOLEX ELECTRONIC TECHNOLOGIES, LLC AND SHOULD NOT BE USED WITHOUT WRITTEN PERMISSION<br>DIMENSION UNITS: <b>MM/IN</b><br>SCALE: <b>1:1</b>  | CURRENT REV DESC: GOLD LENGTH SPEC CHANGED AS MIN 2.54- MAX 5.54 FOR A-42375-0037/0071<br>EC NO: 689596<br>DRWN: SHRUTJ 2021/09/14<br>CHK'D: SHRUTJ 2021/12/20<br>APPR: ISHWARG 2021/12/20 | <br>KK 100 HEADER ASSY<br>FLAT VERTICAL BREAKAWAY<br>PRODUCT CUSTOMER DRAWING |      |      |          |   |   |          |   |        |          |        |   |         |        |   |          |   |   |   |   |
|--|--|--|--|------|------|----------|---|---|----------|---|--------|----------|--------|---|---------|--------|---|----------|---|---|---|---|
|  | GENERAL TOLERANCES (UNLESS SPECIFIED)<br><table border="1"> <tr><th></th><th>MM</th><th>INCH</th></tr> <tr><td>4 PLACES</td><td>±</td><td>±</td></tr> <tr><td>3 PLACES</td><td>±</td><td>± 0.01</td></tr> <tr><td>2 PLACES</td><td>± 0.25</td><td>±</td></tr> <tr><td>1 PLACE</td><td>± 0.38</td><td>±</td></tr> <tr><td>0 PLACES</td><td>±</td><td>±</td></tr> </table> |  |  | MM   | INCH | 4 PLACES | ± | ± | 3 PLACES | ± | ± 0.01 | 2 PLACES | ± 0.25 | ± | 1 PLACE | ± 0.38 | ± | 0 PLACES | ± | ± | INITIAL REVISION:<br>DRWN: SCHAFFER 2003/02/11<br>APPR: MARGULIS 2004/02/27 | DOCUMENT NUMBER: <b>SD-42375-001</b><br>DOC TYPE: PSD<br>DOC PART: 001<br>REVISION: V |
|  |  | MM   |  | INCH |      |          |   |   |          |   |        |          |        |   |         |        |   |          |   |   |   |   |
|  | 4 PLACES   | ±  |  | ±    |      |          |   |   |          |   |        |          |        |   |         |        |   |          |   |   |   |   |
| 3 PLACES   | ±  | ± 0.01   |  |      |      |          |   |   |          |   |        |          |        |   |         |        |   |          |   |   |   |   |
| 2 PLACES   | ± 0.25   | ±  |  |      |      |          |   |   |          |   |        |          |        |   |         |        |   |          |   |   |   |   |
| 1 PLACE  | ± 0.38   | ±  |  |      |      |          |   |   |          |   |        |          |        |   |         |        |   |          |   |   |   |   |
| 0 PLACES   | ±  | ±  |  |      |      |          |   |   |          |   |        |          |        |   |         |        |   |          |   |   |   |   |
| ANGULAR TOL ± 0.5°<br>DRAFT WHERE APPLICABLE MUST REMAIN WITHIN DIMENSIONS   | THIRD ANGLE PROJECTION<br>  | DRAWING: B-SIZE<br>SERIES: 42375<br>MATERIAL NUMBER: SEE CHART<br>CUSTOMER: GENERAL MARKET<br>SHEET NUMBER: 7 OF 35  |  |      |      |          |   |   |          |   |        |          |        |   |         |        |   |          |   |   |   |   |
| DOCUMENT STATUS: P1<br>RELEASE DATE: 2021/12/20 12:18:33   |  |  |  |      |      |          |   |   |          |   |        |          |        |   |         |        |   |          |   |   |   |   |

| ENG. NO: A-42375-0422/0456 |                 |                    |      |                 |              |
|----------------------------|-----------------|--------------------|------|-----------------|--------------|
| HEADER NUMBER:             |                 | 42312-0036         |      |                 |              |
| PIN NUMBER:                |                 | 42663-AYA154       |      |                 |              |
| PIN LENGTH: L              |                 | .545 / 13.84       |      |                 |              |
| MATING LENGTH: M           |                 | .320 / 8.13        |      |                 |              |
| GOLD POINT: G              |                 | N/A                |      |                 |              |
| PC TAIL LENGTH: P          |                 | .135 / 3.43        |      |                 |              |
| TIN: T                     |                 | OVERALL            |      |                 |              |
| CKTS:                      |                 | 2-36               |      |                 |              |
| KINKS:                     |                 | SMES-42003         |      |                 |              |
| VOIDED CKTS:               |                 | NONE               |      |                 |              |
| PACKAGING:                 |                 | BULK PK-40873-0041 |      |                 |              |
| CKTS                       | MATERIAL NUMBER | ENG NUMBER         | CKTS | MATERIAL NUMBER | ENG NUMBER   |
| 2                          | 22-28-5021      | A-42375-0422       | 20   | 22-28-5201      | A-42375-0440 |
| 3                          | 22-28-5031      | A-42375-0423       | 21   | 22-28-5211      | A-42375-0441 |
| 4                          | 22-28-5041      | A-42375-0424       | 22   | 22-28-5221      | A-42375-0442 |
| 5                          | 22-28-5051      | A-42375-0425       | 23   | 22-28-5231      | A-42375-0443 |
| 6                          | 22-28-5061      | A-42375-0426       | 24   | 22-28-5241      | A-42375-0444 |
| 7                          | 22-28-5071      | A-42375-0427       | 25   | 22-28-5251      | A-42375-0445 |
| 8                          | 22-28-5081      | A-42375-0428       | 26   | 22-28-5261      | A-42375-0446 |
| 9                          | 22-28-5091      | A-42375-0429       | 27   | 22-28-5271      | A-42375-0447 |
| 10                         | 22-28-5101      | A-42375-0430       | 28   | 22-28-5281      | A-42375-0448 |
| 11                         | 22-28-5111      | A-42375-0431       | 29   | 22-28-5291      | A-42375-0449 |
| 12                         | 22-28-5121      | A-42375-0432       | 30   | 22-28-5301      | A-42375-0450 |
| 13                         | 22-28-5131      | A-42375-0433       | 31   | 22-28-5311      | A-42375-0451 |
| 14                         | 22-28-5141      | A-42375-0434       | 32   | 22-28-5321      | A-42375-0452 |
| 15                         | 22-28-5151      | A-42375-0435       | 33   | 22-28-5331      | A-42375-0453 |
| 16                         | 22-28-5161      | A-42375-0436       | 34   | 22-28-5341      | A-42375-0454 |
| 17                         | 22-28-5171      | A-42375-0437       | 35   | 22-28-5351      | A-42375-0455 |
| 18                         | 22-28-5181      | A-42375-0438       | 36   | 22-28-5361      | A-42375-0456 |
| 19                         | 22-28-5191      | A-42375-0439       |      |                 |              |

| ENG. NO: A-42375-0457/0491 |                 |                    |      |                 |              |
|----------------------------|-----------------|--------------------|------|-----------------|--------------|
| HEADER NUMBER:             |                 | 42312-0036         |      |                 |              |
| PIN NUMBER:                |                 | 42663-ADB208       |      |                 |              |
| PIN LENGTH: L              |                 | .545 / 13.84       |      |                 |              |
| MATING LENGTH: M           |                 | .320 / 8.13        |      |                 |              |
| GOLD POINT: G              |                 | .140 / 3.56        |      |                 |              |
| PC TAIL LENGTH: P          |                 | .135 / 3.43        |      |                 |              |
| TIN: T                     |                 | .135 / 3.43        |      |                 |              |
| CKTS:                      |                 | 2-36               |      |                 |              |
| KINKS:                     |                 | SMES-42003         |      |                 |              |
| VOIDED CKTS:               |                 | NONE               |      |                 |              |
| PACKAGING:                 |                 | BULK PK-40873-0041 |      |                 |              |
| CKTS                       | MATERIAL NUMBER | ENG NUMBER         | CKTS | MATERIAL NUMBER | ENG NUMBER   |
| 2                          | 22-28-5024      | A-42375-0457       | 20   | 22-28-5204      | A-42375-0475 |
| 3                          | 22-28-5034      | A-42375-0458       | 21   | 22-28-5214      | A-42375-0476 |
| 4                          | 22-28-5044      | A-42375-0459       | 22   | 22-28-5224      | A-42375-0477 |
| 5                          | 22-28-5054      | A-42375-0460       | 23   | 22-28-5234      | A-42375-0478 |
| 6                          | 22-28-5064      | A-42375-0461       | 24   | 22-28-5244      | A-42375-0479 |
| 7                          | 22-28-5074      | A-42375-0462       | 25   | 22-28-5254      | A-42375-0480 |
| 8                          | 22-28-5084      | A-42375-0463       | 26   | 22-28-5264      | A-42375-0481 |
| 9                          | 22-28-5094      | A-42375-0464       | 27   | 22-28-5274      | A-42375-0482 |
| 10                         | 22-28-5104      | A-42375-0365       | 28   | 22-28-5284      | A-42375-0483 |
| 11                         | 22-28-5114      | A-42375-0466       | 29   | 22-28-5294      | A-42375-044  |
| 12                         | 22-28-5124      | A-42375-0467       | 30   | 22-28-5304      | A-42375-0485 |
| 13                         | 22-28-5134      | A-42375-0468       | 31   | 22-28-5314      | A-42375-0486 |
| 14                         | 22-28-5144      | A-42375-0469       | 32   | 22-28-5324      | A-42375-0487 |
| 15                         | 22-28-5154      | A-42375-0470       | 33   | 22-28-5334      | A-42375-0488 |
| 16                         | 22-28-5164      | A-42375-0471       | 34   | 22-28-5344      | A-42375-0489 |
| 17                         | 22-28-5174      | A-42375-0472       | 35   | 22-28-5354      | A-42375-0490 |
| 18                         | 22-28-5184      | A-42375-0473       | 36   | 22-28-5364      | A-42375-0491 |
| 19                         | 22-28-5194      | A-42375-0474       |      |                 |              |

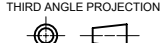
|   |  |  |   |  |
|---|--|--|---|--|
| <b>SYMBOLS</b><br> = 0<br> = 0<br> = 0<br> = 0<br> = 0<br> = 0<br> = 0 | THIS DRAWING CONTAINS INFORMATION THAT IS PROPRIETARY TO MOLEX ELECTRONIC TECHNOLOGIES, LLC AND SHOULD NOT BE USED WITHOUT WRITTEN PERMISSION<br>DIMENSION UNITS: <b>MM/IN</b> SCALE: <b>1:1</b> |  | CURRENT REV DESC: GOLD LENGTH SPEC CHANGED AS MIN 2.54- MAX 5.54 FOR A-42375-0037/0071                          | <br>KK 100 HEADER ASSY<br>FLAT VERTICAL BREAKAWAY<br>PRODUCT CUSTOMER DRAWING |
|   | GENERAL TOLERANCES (UNLESS SPECIFIED)  |  | EC NO: 689596<br>DRWN: SHRUTJ 2021/09/14<br>CHK'D: SHRUTJ 2021/12/20<br>APPR: ISHWARG 2021/12/20                |  |
|   | 4 PLACES ± 0.25 ±<br>3 PLACES ± 0.25 ±<br>2 PLACES ± 0.25 ±<br>1 PLACE ± 0.38 ±<br>0 PLACES ± 0.38 ±   |  | INITIAL REVISION:<br>DRWN: SCHAFFER 2003/02/11<br>APPR: MARGULIS 2004/02/27                                     |  |
|   | ANGULAR TOL ± 0.5°<br>DRAFT WHERE APPLICABLE MUST REMAIN WITHIN DIMENSIONS   |  | THIRD ANGLE PROJECTION<br> |  |
| DOCUMENT STATUS   P1   RELEASE DATE   2021/12/20 12:18:33   |  | DRWG: SCHAFFER 2003/02/11<br>APPR: MARGULIS 2004/02/27 | B-SIZE 42375  | MATERIAL NUMBER: SEE CHART<br>CUSTOMER: GENERAL MARKET<br>SHEET NUMBER: 8 OF 35  |



| ENG. NO: A-42375-0492/0526 |                 |                    |      |                 |              |
|----------------------------|-----------------|--------------------|------|-----------------|--------------|
| HEADER NUMBER:             |                 | 42312-0036         |      |                 |              |
| PIN NUMBER:                |                 | 42663-AYB228       |      |                 |              |
| PIN LENGTH: L              |                 | .545 / 13.84       |      |                 |              |
| MATING LENGTH: M           |                 | .320 / 8.13        |      |                 |              |
| GOLD POINT: G              |                 | 140 / 3.56         |      |                 |              |
| PC TAIL LENGTH: P          |                 | .135 / 3.43        |      |                 |              |
| TIN: T                     |                 | .135 / 3.43        |      |                 |              |
| CKTS:                      |                 | 2-36               |      |                 |              |
| KINKS:                     |                 | SMES-42003         |      |                 |              |
| VOIDED CKTS:               |                 | NONE               |      |                 |              |
| PACKAGING:                 |                 | BULK PK-40873-0041 |      |                 |              |
| CKTS                       | MATERIAL NUMBER | ENG NUMBER         | CKTS | MATERIAL NUMBER | ENG NUMBER   |
| 2                          | 22-28-5027      | A-42375-0492       | 20   | 22-28-5207      | A-42375-0510 |
| 3                          | 22-28-5037      | A-42375-0493       | 21   | 22-28-5217      | A-42375-0511 |
| 4                          | 22-28-5047      | A-42375-0494       | 22   | 22-28-5227      | A-42375-0512 |
| 5                          | 22-28-5057      | A-42375-0495       | 23   | 22-28-5237      | A-42375-0513 |
| 6                          | 22-28-5067      | A-42375-0496       | 24   | 22-28-5247      | A-42375-0514 |
| 7                          | 22-28-5077      | A-42375-0497       | 25   | 22-28-5257      | A-42375-0515 |
| 8                          | 22-28-5087      | A-42375-0498       | 26   | 22-28-5267      | A-42375-0516 |
| 9                          | 22-28-5097      | A-42375-0499       | 27   | 22-28-5277      | A-42375-0517 |
| 10                         | 22-28-5107      | A-42375-0500       | 28   | 22-28-5287      | A-42375-0518 |
| 11                         | 22-28-5117      | A-42375-0501       | 29   | 22-28-5297      | A-42375-0519 |
| 12                         | 22-28-5127      | A-42375-0502       | 30   | 22-28-5307      | A-42375-0520 |
| 13                         | 22-28-5137      | A-42375-0503       | 31   | 22-28-5317      | A-42375-0521 |
| 14                         | 22-28-5147      | A-42375-0504       | 32   | 22-28-5327      | A-42375-0522 |
| 15                         | 22-28-5157      | A-42375-0505       | 33   | 22-28-5337      | A-42375-0523 |
| 16                         | 22-28-5167      | A-42375-0506       | 34   | 22-28-5347      | A-42375-0524 |
| 17                         | 22-28-5177      | A-42375-0507       | 35   | 22-28-5357      | A-42375-0525 |
| 18                         | 22-28-5187      | A-42375-0508       | 36   | 22-28-5367      | A-42375-0526 |
| 19                         | 22-28-5197      | A-42375-0509       |      |                 |              |

| ENG. NO: A-42375-0527/0561 |                 |                    |      |                 |              |
|----------------------------|-----------------|--------------------|------|-----------------|--------------|
| HEADER NUMBER:             |                 | 42312-0036         |      |                 |              |
| PIN NUMBER:                |                 | 42663-ARA154       |      |                 |              |
| PIN LENGTH: L              |                 | .520 / 13.21       |      |                 |              |
| MATING LENGTH: M           |                 | .295 / 7.49        |      |                 |              |
| GOLD POINT: G              |                 | N/A                |      |                 |              |
| PC TAIL LENGTH: P          |                 | .135 / 3.43        |      |                 |              |
| TIN: T                     |                 | OVERALL            |      |                 |              |
| CKTS:                      |                 | 2-36               |      |                 |              |
| KINKS:                     |                 | SMES-42003         |      |                 |              |
| VOIDED CKTS:               |                 | NONE               |      |                 |              |
| PACKAGING:                 |                 | BULK PK-40873-0041 |      |                 |              |
| CKTS                       | MATERIAL NUMBER | ENG NUMBER         | CKTS | MATERIAL NUMBER | ENG NUMBER   |
| 2                          | 22-28-5022      | A-42375-0527       | 20   | 22-28-5202      | A-42375-0545 |
| 3                          | 22-28-5032      | A-42375-0528       | 21   | 22-28-5212      | A-42375-0546 |
| 4                          | 22-28-5042      | A-42375-0529       | 22   | 22-28-5222      | A-42375-0547 |
| 5                          | 22-28-5052      | A-42375-0530       | 23   | 22-28-5232      | A-42375-0548 |
| 6                          | 22-28-5062      | A-42375-0531       | 24   | 22-28-5242      | A-42375-0549 |
| 7                          | 22-28-5072      | A-42375-0532       | 25   | 22-28-5252      | A-42375-0550 |
| 8                          | 22-28-5082      | A-42375-0533       | 26   | 22-28-5262      | A-42375-0551 |
| 9                          | 22-28-5092      | A-42375-0534       | 27   | 22-28-5272      | A-42375-0552 |
| 10                         | 22-28-5102      | A-42375-0435       | 28   | 22-28-5282      | A-42375-0553 |
| 11                         | 22-28-5112      | A-42375-0536       | 29   | 22-28-5292      | A-42375-0554 |
| 12                         | 22-28-5122      | A-42375-0537       | 30   | 22-28-5302      | A-42375-0555 |
| 13                         | 22-28-5132      | A-42375-0538       | 31   | 22-28-5312      | A-42375-0556 |
| 14                         | 22-28-5142      | A-42375-0539       | 32   | 22-28-5322      | A-42375-0557 |
| 15                         | 22-28-5152      | A-42375-0540       | 33   | 22-28-5332      | A-42375-0558 |
| 16                         | 22-28-5162      | A-42375-0541       | 34   | 22-28-5342      | A-42375-0559 |
| 17                         | 22-28-5172      | A-42375-0542       | 35   | 22-28-5352      | A-42375-0560 |
| 18                         | 22-28-5182      | A-42375-0543       | 36   | 22-28-5362      | A-42375-0561 |
| 19                         | 22-28-5192      | A-42375-0544       |      |                 |              |

|                 |   |        |        |                           |  |          |
|-----------------|---|--------|--------|---------------------------|--|----------|
| SYMBOLS         | THIS DRAWING CONTAINS INFORMATION THAT IS PROPRIETARY TO MOLEX ELECTRONIC TECHNOLOGIES, LLC AND SHOULD NOT BE USED WITHOUT WRITTEN PERMISSION |        |        |                           |  |          |
|                 | DIMENSION UNITS   |        | SCALE  |                           | CURRENT REV DESC: GOLD LENGTH SPEC CHANGED AS MIN 2.54- MAX 5.54 FOR A-42375-0037/0071 |          |
|                 | MM/IN   |        | 1:1    |                           |  |          |
|                 | GENERAL TOLERANCES (UNLESS SPECIFIED)   |        |        |                           |  |          |
|                 |   | MM     | INCH   | EC NO: 689596             |  |          |
| ▽ = 0           | 4 PLACES  | ±      | ±      | DRWN: SHRUTJ 2021/09/14   |  |          |
| ▽ = 0           | 3 PLACES  | ±      | ± 0.01 | CHK'D: SHRUTJ 2021/12/20  |  |          |
| ▽ = 0           | 2 PLACES  | ± 0.25 | ±      | APPR: ISHWARG 2021/12/20  |  |          |
| ▽ = 0           | 1 PLACE   | ± 0.38 | ±      | INITIAL REVISION:         |  |          |
| ▽ = 0           | 0 PLACES  | ±      | ±      | DRWN: SCHAFFER 2003/02/11 |  |          |
| □ = 0           | ANGULAR TOL ± 0.5°  |        |        | APPR: MARGULIS 2004/02/27 |  |          |
| ■ = 0           | DRAFT WHERE APPLICABLE MUST REMAIN WITHIN DIMENSIONS  |        |        | THIRD ANGLE PROJECTION    | DRAWING  | SERIES   |
| ▽ = 0           |   |        |        | ⊕                         | B-SIZE   | 42375    |
| DOCUMENT STATUS |   |        | P1     | RELEASE DATE              | 2021/12/20   | 12:18:33 |



KK 100 HEADER ASSY  
FLAT VERTICAL BREAKAWAY

PRODUCT CUSTOMER DRAWING

|                 |          |          |          |
|-----------------|----------|----------|----------|
| DOCUMENT NUMBER | DOC TYPE | DOC PART | REVISION |
| SD-42375-001    | PSD      | 001      | V        |

|                 |                |              |
|-----------------|----------------|--------------|
| MATERIAL NUMBER | CUSTOMER       | SHEET NUMBER |
| SEE CHART       | GENERAL MARKET | 9 OF 35      |

| ENG. NO: A-42375-0562/0596 |                 |                    |      |                 |              |
|----------------------------|-----------------|--------------------|------|-----------------|--------------|
| HEADER NUMBER:             |                 | 42312-0036         |      |                 |              |
| PIN NUMBER:                |                 | 42663-ARB208       |      |                 |              |
| PIN LENGTH: L              |                 | .520 / 13.21       |      |                 |              |
| MATING LENGTH: M           |                 | .295 / 7.49        |      |                 |              |
| GOLD POINT: G              |                 | 140 / 3.56         |      |                 |              |
| PC TAIL LENGTH: P          |                 | .135 / 3.43        |      |                 |              |
| TIN: T                     |                 | .135 / 3.43        |      |                 |              |
| CKTS:                      |                 | 2-36               |      |                 |              |
| KINKS:                     |                 | SMES-42003         |      |                 |              |
| VOIDED CKTS:               |                 | NONE               |      |                 |              |
| PACKAGING:                 |                 | BULK PK-40873-0041 |      |                 |              |
| CKTS                       | MATERIAL NUMBER | ENG NUMBER         | CKTS | MATERIAL NUMBER | ENG NUMBER   |
| 2                          | 22-28-5025      | A-42375-0562       | 20   | 22-28-5205      | A-42375-0580 |
| 3                          | 22-28-5035      | A-42375-0563       | 21   | 22-28-5215      | A-42375-0581 |
| 4                          | 22-28-5045      | A-42375-0564       | 22   | 22-28-5225      | A-42375-0582 |
| 5                          | 22-28-5055      | A-42375-0565       | 23   | 22-28-5235      | A-42375-0583 |
| 6                          | 22-28-5065      | A-42375-0566       | 24   | 22-28-5245      | A-42375-0584 |
| 7                          | 22-28-5075      | A-42375-0567       | 25   | 22-28-5255      | A-42375-0585 |
| 8                          | 22-28-5085      | A-42375-0568       | 26   | 22-28-5265      | A-42375-0586 |
| 9                          | 22-28-5095      | A-42375-0569       | 27   | 22-28-5275      | A-42375-0587 |
| 10                         | 22-28-5105      | A-42375-0570       | 28   | 22-28-5285      | A-42375-0588 |
| 11                         | 22-28-5115      | A-42375-0571       | 29   | 22-28-5295      | A-42375-0589 |
| 12                         | 22-28-5125      | A-42375-0572       | 30   | 22-28-5305      | A-42375-0590 |
| 13                         | 22-28-5135      | A-42375-0573       | 31   | 22-28-5315      | A-42375-0591 |
| 14                         | 22-28-5145      | A-42375-0574       | 32   | 22-28-5325      | A-42375-0592 |
| 15                         | 22-28-5155      | A-42375-0575       | 33   | 22-28-5335      | A-42375-0593 |
| 16                         | 22-28-5165      | A-42375-0576       | 34   | 22-28-5345      | A-42375-0594 |
| 17                         | 22-28-5175      | A-42375-0577       | 35   | 22-28-5355      | A-42375-0595 |
| 18                         | 22-28-5185      | A-42375-0578       | 36   | 22-28-5365      | A-42375-0596 |
| 19                         | 22-28-5195      | A-42375-0579       |      |                 |              |

| ENG. NO: A-42375-0597/0631 |                 |                    |      |                 |              |
|----------------------------|-----------------|--------------------|------|-----------------|--------------|
| HEADER NUMBER:             |                 | 42312-0036         |      |                 |              |
| PIN NUMBER:                |                 | 42663-ARB208       |      |                 |              |
| PIN LENGTH: L              |                 | .520 / 13.21       |      |                 |              |
| MATING LENGTH: M           |                 | .295 / 7.49        |      |                 |              |
| GOLD POINT: G              |                 | 140 / 3.56         |      |                 |              |
| PC TAIL LENGTH: P          |                 | .135 / 3.43        |      |                 |              |
| TIN: T                     |                 | .135 / 3.43        |      |                 |              |
| CKTS:                      |                 | 2-36               |      |                 |              |
| KINKS:                     |                 | SMES-42003         |      |                 |              |
| VOIDED CKTS:               |                 | NONE               |      |                 |              |
| PACKAGING:                 |                 | BULK PK-40873-0041 |      |                 |              |
| CKTS                       | MATERIAL NUMBER | ENG NUMBER         | CKTS | MATERIAL NUMBER | ENG NUMBER   |
| 2                          | 22-28-5028      | A-42375-0597       | 20   | 22-28-5208      | A-42375-0615 |
| 3                          | 22-28-5038      | A-42375-0598       | 21   | 22-28-5218      | A-42375-0616 |
| 4                          | 22-28-5048      | A-42375-0599       | 22   | 22-28-5228      | A-42375-0617 |
| 5                          | 22-28-5058      | A-42375-0600       | 23   | 22-28-5238      | A-42375-0618 |
| 6                          | 22-28-5068      | A-42375-0601       | 24   | 22-28-5248      | A-42375-0619 |
| 7                          | 22-28-5078      | A-42375-0602       | 25   | 22-28-5258      | A-42375-0620 |
| 8                          | 22-28-5088      | A-42375-0603       | 26   | 22-28-5268      | A-42375-0621 |
| 9                          | 22-28-5098      | A-42375-0604       | 27   | 22-28-5278      | A-42375-0622 |
| 10                         | 22-28-5108      | A-42375-0605       | 28   | 22-28-5288      | A-42375-0623 |
| 11                         | 22-28-5118      | A-42375-0606       | 29   | 22-28-5298      | A-42375-0624 |
| 12                         | 22-28-5128      | A-42375-0607       | 30   | 22-28-5308      | A-42375-0625 |
| 13                         | 22-28-5138      | A-42375-0608       | 31   | 22-28-5318      | A-42375-0626 |
| 14                         | 22-28-5148      | A-42375-0609       | 32   | 22-28-5328      | A-42375-0627 |
| 15                         | 22-28-5158      | A-42375-0610       | 33   | 22-28-5338      | A-42375-0628 |
| 16                         | 22-28-5168      | A-42375-0611       | 34   | 22-28-5348      | A-42375-0629 |
| 17                         | 22-28-5178      | A-42375-0612       | 35   | 22-28-5358      | A-42375-0630 |
| 18                         | 22-28-5188      | A-42375-0613       | 36   | 22-28-5368      | A-42375-0631 |
| 19                         | 22-28-5198      | A-42375-0614       |      |                 |              |

|         |   |        |        |  |                |              |
|---------|---|--------|--------|--|----------------|--------------|
| SYMBOLS | THIS DRAWING CONTAINS INFORMATION THAT IS PROPRIETARY TO MOLEX ELECTRONIC TECHNOLOGIES, LLC AND SHOULD NOT BE USED WITHOUT WRITTEN PERMISSION |        |        |  |                |              |
|         | DIMENSION UNITS   | SCALE  |        | CURRENT REV DESC: GOLD LENGTH SPEC CHANGED AS MIN 2.54- MAX 5.54 FOR A-42375-0037/0071 |                |              |
|         | MM/IN   | 1:1    |        |  |                |              |
|         | GENERAL TOLERANCES (UNLESS SPECIFIED)   |        |        |  |                |              |
|         |   | MM     | INCH   | EC NO: 689596  |                |              |
| ▽ = 0   | 4 PLACES  | ±      | ±      | DRWN: SHRUTJ 2021/09/14  |                |              |
| ▽ = 0   | 3 PLACES  | ±      | ± 0.01 | CHK'D: SHRUTJ 2021/12/20   |                |              |
| ▽ = 0   | 2 PLACES  | ± 0.25 | ±      | APPR: ISHWARG 2021/12/20   |                |              |
| ▽ = 0   | 1 PLACE   | ± 0.38 | ±      | INITIAL REVISION:  |                |              |
| ▽ = 0   | 0 PLACES  | ±      | ±      | DRWN: SCHAFFER 2003/02/11  |                |              |
| □ = 0   | ANGULAR TOL ± 0.5°  |        |        | APPR: MARGULIS 2004/02/27  |                |              |
| ■ = 0   | DRAFT WHERE APPLICABLE MUST REMAIN WITHIN DIMENSIONS  |        |        | THIRD ANGLE PROJECTION   | DRAWING        | SERIES       |
| ▽ = 0   |   |        |        |  | B-SIZE         | 42375        |
|         |   |        |        | DOCUMENT NUMBER  | DOC TYPE       | DOC PART     |
|         |   |        |        | SD-42375-001   | PSD            | 001          |
|         |   |        |        | REVISION   | V              |              |
|         |   |        |        | MATERIAL NUMBER  | CUSTOMER       | SHEET NUMBER |
|         |   |        |        | SEE CHART  | GENERAL MARKET | 10 OF 35     |

| ENG. NO: A-42375-0667/0699 |                 |                    |      |                 |              |
|----------------------------|-----------------|--------------------|------|-----------------|--------------|
| HEADER NUMBER:             |                 | 42312-0036         |      |                 |              |
| PIN NUMBER:                |                 | 42663-ABB208       |      |                 |              |
| PIN LENGTH: L              |                 | .455 / 11.56       |      |                 |              |
| MATING LENGTH: M           |                 | .240 / 6.09        |      |                 |              |
| GOLD POINT: G              |                 | .100 / 2.54        |      |                 |              |
| PC TAIL LENGTH: P          |                 | .125 / 3.18        |      |                 |              |
| TIN: T                     |                 | .100 / 2.54        |      |                 |              |
| CKTS:                      |                 | 4-36               |      |                 |              |
| KINKS:                     |                 | NO                 |      |                 |              |
| VOIDED CKTS:               |                 | 4                  |      |                 |              |
| PACKAGING:                 |                 | BULK PK-40873-0041 |      |                 |              |
| CKTS                       | MATERIAL NUMBER | ENG NUMBER         | CKTS | MATERIAL NUMBER | ENG NUMBER   |
| 2                          |                 |                    | 20   | 42375-0683      | A-42375-0683 |
| 3                          |                 |                    | 21   | 42375-0684      | A-42375-0684 |
| 4                          | 42375-0667      | A-42375-0667       | 22   | 42375-0685      | A-42375-0685 |
| 5                          | 42375-0668      | A-42375-0668       | 23   | 42375-0686      | A-42375-0686 |
| 6                          | 22-30-3060      | A-42375-0669       | 24   | 42375-0687      | A-42375-0687 |
| 7                          | 42375-0670      | A-42375-0670       | 25   | 42375-0688      | A-42375-0688 |
| 8                          | 42375-0671      | A-42375-0671       | 26   | 42375-0689      | A-42375-0689 |
| 9                          | 42375-0672      | A-42375-0672       | 27   | 42375-0690      | A-42375-0690 |
| 10                         | 42375-0673      | A-42375-0673       | 28   | 42375-0691      | A-42375-0691 |
| 11                         | 42375-0674      | A-42375-0674       | 29   | 42375-0692      | A-42375-0692 |
| 12                         | 22-30-3120      | A-42375-0675       | 30   | 42375-0693      | A-42375-0693 |
| 13                         | 42375-0676      | A-42375-0676       | 31   | 42375-0694      | A-42375-0694 |
| 14                         | 42375-0677      | A-42375-0677       | 32   | 42375-0695      | A-42375-0695 |
| 15                         | 42375-0678      | A-42375-0678       | 33   | 42375-0696      | A-42375-0696 |
| 16                         | 42375-0679      | A-42375-0679       | 34   | 42375-0697      | A-42375-0697 |
| 17                         | 42375-0680      | A-42375-0680       | 35   | 42375-0698      | A-42375-0698 |
| 18                         | 42375-0681      | A-42375-0681       | 36   | 42375-0699      | A-42375-0699 |
| 19                         | 42375-0682      | A-42375-0682       |      |                 |              |

| ENG. NO: A-42375-0700/0732 |                 |                    |      |                 |              |
|----------------------------|-----------------|--------------------|------|-----------------|--------------|
| HEADER NUMBER:             |                 | 42312-0036         |      |                 |              |
| PIN NUMBER:                |                 | 42663-ADB208       |      |                 |              |
| PIN LENGTH: L              |                 | .465 / 11.81       |      |                 |              |
| MATING LENGTH: M           |                 | .240 / 6.09        |      |                 |              |
| GOLD POINT: G              |                 | .100 / 2.54        |      |                 |              |
| PC TAIL LENGTH: P          |                 | .135 / 3.43        |      |                 |              |
| TIN: T                     |                 | .100 / 2.54        |      |                 |              |
| CKTS:                      |                 | 4-36               |      |                 |              |
| KINKS:                     |                 | SMES-42003         |      |                 |              |
| VOIDED CKTS:               |                 | 4                  |      |                 |              |
| PACKAGING:                 |                 | BULK PK-40873-0041 |      |                 |              |
| CKTS                       | MATERIAL NUMBER | ENG NUMBER         | CKTS | MATERIAL NUMBER | ENG NUMBER   |
| 2                          |                 |                    | 20   | 42375-0716      | A-42375-0716 |
| 3                          |                 |                    | 21   | 42375-0717      | A-42375-0717 |
| 4                          | 42375-0700      | A-42375-0700       | 22   | 42375-0718      | A-42375-0718 |
| 5                          | 42375-0701      | A-42375-0701       | 23   | 42375-0719      | A-42375-0719 |
| 6                          | 22-30-3061      | A-42375-0702       | 24   | 42375-0720      | A-42375-0720 |
| 7                          | 42375-0703      | A-42375-0703       | 25   | 42375-0721      | A-42375-0721 |
| 8                          | 42375-0704      | A-42375-0704       | 26   | 42375-0722      | A-42375-0722 |
| 9                          | 42375-0705      | A-42375-0705       | 27   | 42375-0723      | A-42375-0723 |
| 10                         | 42375-0706      | A-42375-0706       | 28   | 42375-0724      | A-42375-0724 |
| 11                         | 42375-0707      | A-42375-0707       | 29   | 42375-0725      | A-42375-0725 |
| 12                         | 42375-0708      | A-42375-0708       | 30   | 42375-0726      | A-42375-0726 |
| 13                         | 42375-0709      | A-42375-0709       | 31   | 42375-0727      | A-42375-0727 |
| 14                         | 42375-0710      | A-42375-0710       | 32   | 42375-0728      | A-42375-0728 |
| 15                         | 42375-0711      | A-42375-0711       | 33   | 42375-0729      | A-42375-0729 |
| 16                         | 42375-0712      | A-42375-0712       | 34   | 42375-0730      | A-42375-0730 |
| 17                         | 42375-0713      | A-42375-0713       | 35   | 42375-0731      | A-42375-0731 |
| 18                         | 42375-0714      | A-42375-0714       | 36   | 42375-0732      | A-42375-0732 |
| 19                         | 42375-0715      | A-42375-0715       |      |                 |              |

|         |   |        |        |                           |  |        |
|---------|---|--------|--------|---------------------------|--|--------|
| SYMBOLS | THIS DRAWING CONTAINS INFORMATION THAT IS PROPRIETARY TO MOLEX ELECTRONIC TECHNOLOGIES, LLC AND SHOULD NOT BE USED WITHOUT WRITTEN PERMISSION |        |        |                           |  |        |
|         | DIMENSION UNITS   |        | SCALE  |                           | CURRENT REV DESC: GOLD LENGTH SPEC CHANGED AS MIN 2.54- MAX 5.54 FOR A-42375-0037/0071 |        |
|         | MM/IN   |        | 1:1    |                           |  |        |
|         | GENERAL TOLERANCES (UNLESS SPECIFIED)   |        |        |                           |  |        |
|         |   | MM     | INCH   | EC NO: 689596             |  |        |
| ▽ = 0   | 4 PLACES  | ±      | ±      | DRWN: SHRUTJ 2021/09/14   |  |        |
| ▽ = 0   | 3 PLACES  | ±      | ± 0.01 | CHK'D: SHRUTJ 2021/12/20  |  |        |
| ▽ = 0   | 2 PLACES  | ± 0.25 | ±      | APPR: ISHWARG 2021/12/20  |  |        |
| ▽ = 0   | 1 PLACE   | ± 0.38 | ±      | INITIAL REVISION:         |  |        |
| ▽ = 0   | 0 PLACES  | ±      | ±      | DRWN: SCHAFFER 2003/02/11 |  |        |
| □ = 0   | ANGULAR TOL ± 0.5°  |        |        | APPR: MARGULIS 2004/02/27 |  |        |
| ■ = 0   | DRAFT WHERE APPLICABLE MUST REMAIN WITHIN DIMENSIONS  |        |        | THIRD ANGLE PROJECTION    | DRAWING  | SERIES |
| ▽ = 0   |   |        |        | ⊕                         | B-SIZE   | 42375  |

|   |                |              |
|---|----------------|--------------|
| <b>molex</b>                                  |                |              |
| KK 100 HEADER ASSY<br>FLAT VERTICAL BREAKAWAY |                |              |
| PRODUCT CUSTOMER DRAWING                      |                |              |
| DOCUMENT NUMBER                               | DOC TYPE       | DOC PART     |
| SD-42375-001                                  | PSD            | 001          |
| REVISION                                      |                |              |
| V   |                |              |
| MATERIAL NUMBER                               | CUSTOMER       | SHEET NUMBER |
| SEE CHART                                     | GENERAL MARKET | 11 OF 35     |

|                            |                 |                    |      |                 |              |
|----------------------------|-----------------|--------------------|------|-----------------|--------------|
| ENG. NO: A-42375-0836/0870 |                 |                    |      |                 |              |
| HEADER NUMBER:             |                 | 42312-0036         |      |                 |              |
| PIN NUMBER:                |                 | 42663-BSA154       |      |                 |              |
| PIN LENGTH: L              |                 | .630 / 16.00       |      |                 |              |
| MATING LENGTH: M           |                 | .405/10.29         |      |                 |              |
| GOLD POINT: G              |                 | N/A                |      |                 |              |
| PC TAIL LENGTH: P          |                 | .135 / 3.43        |      |                 |              |
| TIN: T                     |                 | OVERALL            |      |                 |              |
| CKTS:                      |                 | 2-36               |      |                 |              |
| KINKS:                     |                 | SMES-42003         |      |                 |              |
| VOIDED CKTS:               |                 | NONE               |      |                 |              |
| PACKAGING:                 |                 | BULK PK-40873-0041 |      |                 |              |
| CKTS                       | MATERIAL NUMBER | ENG NUMBER         | CKTS | MATERIAL NUMBER | ENG NUMBER   |
| 2                          |                 | A-42375-0836       | 20   | 22-30-3203      | A-42375-0854 |
| 3                          | 22-28-3033      | A-42375-0837       | 21   | 22-30-3213      | A-42375-0855 |
| 4                          | 22-28-3043      | A-42375-0838       | 22   | 22-30-3223      | A-42375-0856 |
| 5                          | 22-28-3053      | A-42375-0839       | 23   | 22-30-3233      | A-42375-0857 |
| 6                          | 22-28-3063      | A-42375-0840       | 24   | 22-30-3243      | A-42375-0858 |
| 7                          | 22-28-3073      | A-42375-0841       | 25   | 22-30-3253      | A-42375-0859 |
| 8                          | 22-28-3083      | A-42375-0842       | 26   | 22-30-3263      | A-42375-0860 |
| 9                          | 22-28-3093      | A-42375-0843       | 27   | 22-30-3273      | A-42375-0861 |
| 10                         | 22-30-3103      | A-42375-0844       | 28   | 22-30-3283      | A-42375-0862 |
| 11                         | 22-30-3113      | A-42375-0845       | 29   | 22-30-3293      | A-42375-0863 |
| 12                         | 22-30-3123      | A-42375-0846       | 30   | 22-30-3303      | A-42375-0864 |
| 13                         | 22-30-3133      | A-42375-0847       | 31   | 22-30-3313      | A-42375-0865 |
| 14                         | 22-30-3143      | A-42375-0848       | 32   | 22-30-3323      | A-42375-0866 |
| 15                         | 22-30-3153      | A-42375-0849       | 33   | 22-30-3333      | A-42375-0867 |
| 16                         | 22-30-3163      | A-42375-0850       | 34   | 22-30-3343      | A-42375-0868 |
| 17                         | 22-30-3173      | A-42375-0851       | 35   | 22-30-3353      | A-42375-0869 |
| 18                         | 22-30-3183      | A-42375-0852       | 36   | 22-30-3363      | A-42375-0870 |
| 19                         | 22-30-3193      | A-42375-0853       |      |                 |              |

|   |  |  |  |                        |  |  |  |        |  |
|---|--|--|--|------------------------|--|--|--|--------|--|
| THIS DRAWING CONTAINS INFORMATION THAT IS PROPRIETARY TO MOLEX ELECTRONIC TECHNOLOGIES, LLC AND SHOULD NOT BE USED WITHOUT WRITTEN PERMISSION |  |  |  |                        |  |  |  |        |  |
| SYMBOLS   |  | DIMENSION UNITS                                      |  | SCALE                  |  | CURRENT REV DESC: GOLD LENGTH SPEC CHANGED AS MIN 2.54- MAX 5.54 FOR A-42375-0037/0071   |  |        |  |
| ▽ = 0   |  | MM/IN  |  | 1:1                    |  | <p><b>molex</b></p> <p>KK 100 HEADER ASSY<br/>FLAT VERTICAL BREAKAWAY</p> <p>PRODUCT CUSTOMER DRAWING</p> <p>DOCUMENT NUMBER: SD-42375-001   DOC TYPE: PSD   DOC PART: 001   REVISION: V</p> <p>EC NO: 689596<br/>DRWN: SHRUTJ 2021/09/14<br/>CHK'D: SHRUTJ 2021/12/20<br/>APPR: ISHWARG 2021/12/20</p> <p>INITIAL REVISION:<br/>DRWN: SCHAFFER 2003/02/11<br/>APPR: MARGULIS 2004/02/27</p> <p>MATERIAL NUMBER: SEE CHART   CUSTOMER: GENERAL MARKET   SHEET NUMBER: 12 OF 35</p> |  |        |  |
| ▽ = 0   |  | GENERAL TOLERANCES (UNLESS SPECIFIED)                |  |                        |  |  |  |        |  |
| ▽ = 0   |  | MM   |  | INCH                   |  |  |  |        |  |
| ▽ = 0   |  | 4 PLACES ±   |  | ±                      |  |  |  |        |  |
| ▽ = 0   |  | 3 PLACES ±   |  | ± 0.01                 |  |  |  |        |  |
| ▽ = 0   |  | 2 PLACES ±   |  | ± 0.25                 |  |  |  |        |  |
| ▽ = 0   |  | 1 PLACE ±  |  | ± 0.38                 |  |  |  |        |  |
| ▽ = 0   |  | 0 PLACES ±   |  | ±                      |  |  |  |        |  |
| ▽ = 0   |  | ANGULAR TOL ±  |  | ± 0.5°                 |  |  |  |        |  |
| ▽ = 0   |  | DRAFT WHERE APPLICABLE MUST REMAIN WITHIN DIMENSIONS |  | THIRD ANGLE PROJECTION |  | DRAWING  |  | SERIES |  |
| ▽ = 0   |  |  |  |                        |  | B-SIZE   |  | 42375  |  |

| ENG. NO: A-42375-0871/0904 |                 |                    |      |                 |              |
|----------------------------|-----------------|--------------------|------|-----------------|--------------|
| HEADER NUMBER:             |                 | 42312-0036         |      |                 |              |
| PIN NUMBER:                |                 | 42663-ATA154       |      |                 |              |
| PIN LENGTH: L              |                 | .530 / 13.46       |      |                 |              |
| MATING LENGTH: M           |                 | .320 / 8.13        |      |                 |              |
| GOLD POINT: G              |                 | N/A                |      |                 |              |
| PC TAIL LENGTH: P          |                 | .120 / 3.05        |      |                 |              |
| TIN: T                     |                 | OVERALL            |      |                 |              |
| CKTS:                      |                 | 3-36               |      |                 |              |
| KINKS:                     |                 | NO                 |      |                 |              |
| VOIDED CKTS:               |                 | 2                  |      |                 |              |
| PACKAGING:                 |                 | BULK PK-40873-0041 |      |                 |              |
| CKTS                       | MATERIAL NUMBER | ENG NUMBER         | CKTS | MATERIAL NUMBER | ENG NUMBER   |
| 2                          |                 |                    | 20   | 22-30-3204      | A-42375-0888 |
| 3                          | 22-28-3034      | A-42375-0871       | 21   | 22-30-3214      | A-42375-0889 |
| 4                          | 22-28-3044      | A-42375-0872       | 22   | 22-30-3224      | A-42375-0890 |
| 5                          | 22-28-3054      | A-42375-0873       | 23   | 22-30-3234      | A-42375-0891 |
| 6                          | 22-28-3064      | A-42375-08474      | 24   | 22-30-3244      | A-42375-0892 |
| 7                          | 22-28-3074      | A-42375-0875       | 25   | 22-30-3254      | A-42375-0893 |
| 8                          | 22-28-3084      | A-42375-0876       | 26   | 22-30-3264      | A-42375-0894 |
| 9                          | 22-28-3094      | A-42375-0877       | 27   | 22-30-3274      | A-42375-0895 |
| 10                         | 22-30-3104      | A-42375-0878       | 28   | 22-30-3284      | A-42375-0896 |
| 11                         | 22-30-3114      | A-42375-0879       | 29   | 22-30-3294      | A-42375-0897 |
| 12                         | 22-30-3124      | A-42375-0880       | 30   | 22-30-3304      | A-42375-0898 |
| 13                         | 22-30-3134      | A-42375-0881       | 31   | 22-30-3314      | A-42375-0899 |
| 14                         | 22-30-3144      | A-42375-0882       | 32   | 22-30-3324      | A-42375-0900 |
| 15                         | 22-30-3154      | A-42375-0883       | 33   | 22-30-3334      | A-42375-0901 |
| 16                         | 22-30-3164      | A-42375-0884       | 34   | 22-30-3344      | A-42375-0902 |
| 17                         | 22-30-3174      | A-42375-0885       | 35   | 22-30-3354      | A-42375-0903 |
| 18                         | 22-30-3184      | A-42375-0886       | 36   | 22-30-3364      | A-42375-0904 |
| 19                         | 22-30-3194      | A-42375-0887       |      |                 |              |

| ENG. NO: A-42375-0973/1001 |                 |                    |      |                 |              |
|----------------------------|-----------------|--------------------|------|-----------------|--------------|
| HEADER NUMBER:             |                 | 42312-0036         |      |                 |              |
| PIN NUMBER:                |                 | 42663-ABA154       |      |                 |              |
| PIN LENGTH: L              |                 | .455 / 11.56       |      |                 |              |
| MATING LENGTH: M           |                 | .240 / 6.09        |      |                 |              |
| GOLD POINT: G              |                 | N/A                |      |                 |              |
| PC TAIL LENGTH: P          |                 | .125 / 3.18        |      |                 |              |
| TIN: T                     |                 | OVERALL            |      |                 |              |
| CKTS:                      |                 | 8-36               |      |                 |              |
| KINKS:                     |                 | NO                 |      |                 |              |
| VOIDED CKTS:               |                 | 3,8                |      |                 |              |
| PACKAGING:                 |                 | BULK PK-40873-0041 |      |                 |              |
| CKTS                       | MATERIAL NUMBER | ENG NUMBER         | CKTS | MATERIAL NUMBER | ENG NUMBER   |
| 2                          |                 |                    | 20   | 42375-0985      | A-42375-0985 |
| 3                          |                 |                    | 21   | 42375-0986      | A-42375-0986 |
| 4                          |                 |                    | 22   | 42375-0987      | A-42375-0987 |
| 5                          |                 |                    | 23   | 42375-0988      | A-42375-0988 |
| 6                          |                 |                    | 24   | 42375-0989      | A-42375-0989 |
| 7                          |                 |                    | 25   | 42375-0990      | A-42375-0990 |
| 8                          | 42375-0973      | A-42375-0973       | 26   | 42375-0991      | A-42375-0991 |
| 9                          | 42375-0974      | A-42375-0974       | 27   | 42375-0992      | A-42375-0992 |
| 10                         | 22-30-3107      | A-42375-0975       | 28   | 42375-0993      | A-42375-0993 |
| 11                         | 42375-0976      | A-42375-0976       | 29   | 42375-0994      | A-42375-0994 |
| 12                         | 42375-0977      | A-42375-0977       | 30   | 42375-0995      | A-42375-0995 |
| 13                         | 42375-0978      | A-42375-0978       | 31   | 42375-0996      | A-42375-0996 |
| 14                         | 42375-0979      | A-42375-0979       | 32   | 42375-0997      | A-42375-0997 |
| 15                         | 42375-0980      | A-42375-0980       | 33   | 42375-0998      | A-42375-0998 |
| 16                         | 42375-0981      | A-42375-0981       | 34   | 42375-0999      | A-42375-0999 |
| 17                         | 42375-0982      | A-42375-0982       | 35   | 42375-1000      | A-42375-1000 |
| 18                         | 42375-0983      | A-42375-0983       | 36   | 42375-1001      | A-42375-1001 |
| 19                         | 42375-0984      | A-42375-0984       |      |                 |              |

DOCUMENT STATUS | P1 | RELEASE DATE | 2021/12/20 12:18:33

| <b>SYMBOLS</b><br>= 0<br>= 0<br>= 0<br>= 0<br>= 0<br>= 0<br>= 0<br>= 0<br>= 0 | THIS DRAWING CONTAINS INFORMATION THAT IS PROPRIETARY TO MOLEX ELECTRONIC TECHNOLOGIES, LLC AND SHOULD NOT BE USED WITHOUT WRITTEN PERMISSION<br>DIMENSION UNITS: <b>MM/IN</b><br>SCALE: <b>1:1</b>   | CURRENT REV DESC: GOLD LENGTH SPEC CHANGED AS MIN 2.54- MAX 5.54 FOR A-42375-0037/0071<br>EC NO: 689596<br>DRWN: SHRUTJ 2021/09/14<br>CHK'D: SHRUTJ 2021/12/20<br>APPR: ISHWARG 2021/12/20 | <br>KK 100 HEADER ASSY<br>FLAT VERTICAL BREAKAWAY<br>PRODUCT CUSTOMER DRAWING    |      |      |            |  |  |            |  |        |            |        |  |           |        |  |            |  |  |   |   |
|---|---|--|--|------|------|------------|--|--|------------|--|--------|------------|--------|--|-----------|--------|--|------------|--|--|---|---|
|   | GENERAL TOLERANCES (UNLESS SPECIFIED)<br><table border="1"> <tr> <th></th> <th>MM</th> <th>INCH</th> </tr> <tr> <td>4 PLACES ±</td> <td></td> <td></td> </tr> <tr> <td>3 PLACES ±</td> <td></td> <td>± 0.01</td> </tr> <tr> <td>2 PLACES ±</td> <td>± 0.25</td> <td></td> </tr> <tr> <td>1 PLACE ±</td> <td>± 0.38</td> <td></td> </tr> <tr> <td>0 PLACES ±</td> <td></td> <td></td> </tr> </table> |  |  | MM   | INCH | 4 PLACES ± |  |  | 3 PLACES ± |  | ± 0.01 | 2 PLACES ± | ± 0.25 |  | 1 PLACE ± | ± 0.38 |  | 0 PLACES ± |  |  | INITIAL REVISION:<br>DRWN: SCHAFFER 2003/02/11<br>APPR: MARGULIS 2004/02/27 | DOCUMENT NUMBER: <b>SD-42375-001</b><br>DOC TYPE: PSD<br>DOC PART: 001<br>REVISION: V |
|   |   | MM   |  | INCH |      |            |  |  |            |  |        |            |        |  |           |        |  |            |  |  |   |   |
|   | 4 PLACES ±  |  |  |      |      |            |  |  |            |  |        |            |        |  |           |        |  |            |  |  |   |   |
| 3 PLACES ±  |   | ± 0.01   |  |      |      |            |  |  |            |  |        |            |        |  |           |        |  |            |  |  |   |   |
| 2 PLACES ±  | ± 0.25  |  |  |      |      |            |  |  |            |  |        |            |        |  |           |        |  |            |  |  |   |   |
| 1 PLACE ±   | ± 0.38  |  |  |      |      |            |  |  |            |  |        |            |        |  |           |        |  |            |  |  |   |   |
| 0 PLACES ±  |   |  |  |      |      |            |  |  |            |  |        |            |        |  |           |        |  |            |  |  |   |   |
| ANGULAR TOL ± 0.5°<br>DRAFT WHERE APPLICABLE MUST REMAIN WITHIN DIMENSIONS    | THIRD ANGLE PROJECTION<br>  | DRAWING: B-SIZE<br>SERIES: 42375   | MATERIAL NUMBER: SEE CHART<br>CUSTOMER: GENERAL MARKET<br>SHEET NUMBER: 13 OF 35 |      |      |            |  |  |            |  |        |            |        |  |           |        |  |            |  |  |   |   |

| ENG. NO: A-42375-1105/1139 |                 |                    |      |                 |              |
|----------------------------|-----------------|--------------------|------|-----------------|--------------|
| HEADER NUMBER:             |                 | 42312-0036         |      |                 |              |
| PIN NUMBER:                |                 | 42663-ABB208       |      |                 |              |
| PIN LENGTH: L              |                 | .455 / 11.56       |      |                 |              |
| MATING LENGTH: M           |                 | .240 / 6.09        |      |                 |              |
| GOLD POINT: G              |                 | .100 / 2.54        |      |                 |              |
| PC TAIL LENGTH: P          |                 | .125 / 3.18        |      |                 |              |
| TIN: T                     |                 | .100 / 2.54        |      |                 |              |
| CKTS:                      |                 | 2-36               |      |                 |              |
| KINKS:                     |                 | NO                 |      |                 |              |
| VOIDED CKTS:               |                 | 4                  |      |                 |              |
| PACKAGING:                 |                 | BULK PK-40873-0041 |      |                 |              |
| CKTS                       | MATERIAL NUMBER | ENG NUMBER         | CKTS | MATERIAL NUMBER | ENG NUMBER   |
| 2                          | 42375-1105      | A-42375-1105       | 20   | 42375-1123      | A-42375-1123 |
| 3                          | 42375-1106      | A-42375-1106       | 21   | 42375-1124      | A-42375-1124 |
| 4                          | 42375-1107      | A-42375-1107       | 22   | 42375-1125      | A-42375-1125 |
| 5                          | 42375-1108      | A-42375-1108       | 23   | 42375-1126      | A-42375-1126 |
| 6                          | 42375-1109      | A-42375-1109       | 24   | 42375-1127      | A-42375-1127 |
| 7                          | 42375-1110      | A-42375-1110       | 25   | 42375-1128      | A-42375-1128 |
| 8                          | 42375-1111      | A-42375-1111       | 26   | 42375-1129      | A-42375-1129 |
| 9                          | 42375-1112      | A-42375-1112       | 27   | 42375-1130      | A-42375-1130 |
| 10                         | 42375-1113      | A-42375-1113       | 28   | 42375-1131      | A-42375-1131 |
| 11                         | 42375-1114      | A-42375-1114       | 29   | 42375-1132      | A-42375-1132 |
| 12                         | 42375-1115      | A-42375-1115       | 30   | 42375-1133      | A-42375-1133 |
| 13                         | 42375-1116      | A-42375-1116       | 31   | 42375-1134      | A-42375-1134 |
| 14                         | 42375-1117      | A-42375-1117       | 32   | 42375-1135      | A-42375-1135 |
| 15                         | 42375-1118      | A-42375-1118       | 33   | 42375-1136      | A-42375-1136 |
| 16                         | 42375-1119      | A-42375-1119       | 34   | 42375-1137      | A-42375-1137 |
| 17                         | 42375-1120      | A-42375-1120       | 35   | 42375-1138      | A-42375-1138 |
| 18                         | 42375-1121      | A-42375-1121       | 36   | 42375-1139      | A-42375-1139 |
| 19                         | 42375-1122      | A-42375-1122       |      |                 |              |

| ENG. NO: 42375-1244/1278 |             |                    |                 |
|--------------------------|-------------|--------------------|-----------------|
| HEADER NUMBER:           |             | 42312-0036         |                 |
| PIN NUMBER:              |             | 42663-ABA154       |                 |
| PIN LENGTH: L            |             | .455 / 11.56       |                 |
| MATING LENGTH: M         |             | .240 / 6.09        |                 |
| GOLD POINT: G            |             | N/A                |                 |
| PC TAIL LENGTH: P        |             | .125 / 3.18        |                 |
| TIN: T                   |             | OVERALL            |                 |
| CKTS:                    |             | 2-36               |                 |
| KINKS:                   |             | NO                 |                 |
| VOIDED CKTS:             |             | 2                  |                 |
| PACKAGING:               |             | BULK PK-40873-0041 |                 |
| CKTS                     | ITEM NUMBER | CKTS               | MATERIAL NUMBER |
| 2                        | 42375-1244  | 20                 | 42375-1262      |
| 3                        | 42375-1245  | 21                 | 42375-1263      |
| 4                        | 42375-1246  | 22                 | 42375-1264      |
| 5                        | 42375-1247  | 23                 | 42375-1265      |
| 6                        | 42375-1248  | 24                 | 42375-1266      |
| 7                        | 42375-1249  | 25                 | 42375-1267      |
| 8                        | 42375-1250  | 26                 | 42375-1268      |
| 9                        | 42375-1251  | 27                 | 42375-1269      |
| 10                       | 42375-1252  | 28                 | 42375-1270      |
| 11                       | 42375-1253  | 29                 | 42375-1271      |
| 12                       | 42375-1254  | 30                 | 42375-1272      |
| 13                       | 42375-1255  | 31                 | 42375-1273      |
| 14                       | 42375-1256  | 32                 | 42375-1274      |
| 15                       | 42375-1257  | 33                 | 42375-1275      |
| 16                       | 42375-1258  | 34                 | 42375-1276      |
| 17                       | 42375-1259  | 35                 | 42375-1277      |
| 18                       | 42375-1260  | 36                 | 42375-1278      |
| 19                       | 42375-1261  |                    |                 |

|         |   |         |  |
|---------|---|---------|--|
| SYMBOLS | THIS DRAWING CONTAINS INFORMATION THAT IS PROPRIETARY TO MOLEX ELECTRONIC TECHNOLOGIES, LLC AND SHOULD NOT BE USED WITHOUT WRITTEN PERMISSION |         |  |
|         | DIMENSION UNITS   | SCALE   | CURRENT REV DESC: GOLD LENGTH SPEC CHANGED AS MIN 2.54- MAX 5.54 FOR A-42375-0037/0071   |
| ▽ = 0   | MM/IN   | 1:1     | <br>KK 100 HEADER ASSY<br>FLAT VERTICAL BREAKAWAY |
| ▽ = 0   | GENERAL TOLERANCES (UNLESS SPECIFIED)   |         |  |
| ▽ = 0   |   |         | EC NO: 689596<br>DRWN: SHRUTJ 2021/09/14<br>CHK'D: SHRUTJ 2021/12/20<br>APPR: ISHWARG 2021/12/20                                       |
| ▽ = 0   | 4 PLACES ±  | ±       |  |
| ▽ = 0   | 3 PLACES ±  | ± 0.01  | PRODUCT CUSTOMER DRAWING<br>DOCUMENT NUMBER: SD-42375-001<br>DOC TYPE: PSD<br>DOC PART: 001<br>REVISION: V                             |
| ▽ = 0   | 2 PLACES ±  | ± 0.25  |  |
| ▽ = 0   | 1 PLACE ±   | ± 0.38  | INITIAL REVISION:<br>DRWN: SCHAFFER 2003/02/11<br>APPR: MARGULIS 2004/02/27  |
| ▽ = 0   | 0 PLACES ±  | ±       |  |
| ▽ = 0   | ANGULAR TOL ± 0.5°  |         | MATERIAL NUMBER: SEE CHART<br>CUSTOMER: GENERAL MARKET<br>SHEET NUMBER: 14 OF 35   |
| ▽ = 0   | DRAFT WHERE APPLICABLE MUST REMAIN WITHIN DIMENSIONS  |         |  |
| ▽ = 0   | THIRD ANGLE PROJECTION  | DRAWING | SERIES   |
|         |    | B-SIZE  | 42375  |

| ENG. NO: 42375-1349/1382 |             |                    |             |
|--------------------------|-------------|--------------------|-------------|
| HEADER NUMBER:           |             | 42312-0036         |             |
| PIN NUMBER:              |             | 42663-ABA154       |             |
| PIN LENGTH: L            |             | .455 / 11.56       |             |
| MATING LENGTH: M         |             | .230 / 5.84        |             |
| GOLD POINT: G            |             | N/A                |             |
| PC TAIL LENGTH: P        |             | .135 / 3.43        |             |
| TIN: T                   |             | OVERALL            |             |
| CKTS:                    |             | 3-36               |             |
| KINKS:                   |             | SMES-42003         |             |
| VOIDED CKTS:             |             | 2                  |             |
| PACKAGING:               |             | BULK PK-40873-0041 |             |
| CKTS                     | ITEM NUMBER | CKTS               | ITEM NUMBER |
| 2                        |             | 20                 | 42375-1366  |
| 3                        | 42375-1349  | 21                 | 42375-1367  |
| 4                        | 42375-1350  | 22                 | 42375-1368  |
| 5                        | 42375-1351  | 23                 | 42375-1369  |
| 6                        | 42375-1352  | 24                 | 42375-1370  |
| 7                        | 42375-1353  | 25                 | 42375-1371  |
| 8                        | 42375-1354  | 26                 | 42375-1372  |
| 9                        | 42375-1355  | 27                 | 42375-1373  |
| 10                       | 42375-1356  | 28                 | 42375-1374  |
| 11                       | 42375-1357  | 29                 | 42375-1375  |
| 12                       | 42375-1358  | 30                 | 42375-1376  |
| 13                       | 42375-1359  | 31                 | 42375-1377  |
| 14                       | 42375-1360  | 32                 | 42375-1378  |
| 15                       | 42375-1361  | 33                 | 42375-1379  |
| 16                       | 42375-1362  | 34                 | 42375-1380  |
| 17                       | 42375-1363  | 35                 | 42375-1381  |
| 18                       | 42375-1364  | 36                 | 42375-1382  |
| 19                       | 42375-1365  |                    |             |

| ENG. NO: 42375-1515/1548 |             |                    |             |
|--------------------------|-------------|--------------------|-------------|
| HEADER NUMBER:           |             | 42312-0036         |             |
| PIN NUMBER:              |             | 42663-ABB208       |             |
| PIN LENGTH: L            |             | .455 / 11.56       |             |
| MATING LENGTH: M         |             | .230 / 5.84        |             |
| GOLD POINT: G            |             | .140 / 3.56        |             |
| PC TAIL LENGTH: P        |             | .135 / 3.43        |             |
| TIN: T                   |             | .100 / 2.54        |             |
| CKTS:                    |             | 3-36               |             |
| KINKS:                   |             | SMES-42003         |             |
| VOIDED CKTS:             |             | 2                  |             |
| PACKAGING:               |             | BULK PK-40873-0041 |             |
| CKTS                     | ITEM NUMBER | CKTS               | ITEM NUMBER |
| 2                        |             | 20                 | 42375-1532  |
| 3                        | 42375-1515  | 21                 | 42375-1533  |
| 4                        | 42375-1516  | 22                 | 42375-1534  |
| 5                        | 42375-1517  | 23                 | 42375-1535  |
| 6                        | 42375-1518  | 24                 | 42375-1536  |
| 7                        | 42375-1519  | 25                 | 42375-1537  |
| 8                        | 42375-1520  | 26                 | 42375-1538  |
| 9                        | 42375-1521  | 27                 | 42375-1539  |
| 10                       | 42375-1522  | 28                 | 42375-1540  |
| 11                       | 42375-1523  | 29                 | 42375-1541  |
| 12                       | 42375-1524  | 30                 | 42375-1542  |
| 13                       | 42375-1525  | 31                 | 42375-1543  |
| 14                       | 42375-1526  | 32                 | 42375-1544  |
| 15                       | 42375-1527  | 33                 | 42375-1545  |
| 16                       | 42375-1528  | 34                 | 42375-1546  |
| 17                       | 42375-1529  | 35                 | 42375-1547  |
| 18                       | 42375-1530  | 36                 | 42375-1548  |
| 19                       | 42375-1531  |                    |             |

|         |   |         |  |
|---------|---|---------|--|
| SYMBOLS | THIS DRAWING CONTAINS INFORMATION THAT IS PROPRIETARY TO MOLEX ELECTRONIC TECHNOLOGIES, LLC AND SHOULD NOT BE USED WITHOUT WRITTEN PERMISSION |         |  |
|         | DIMENSION UNITS   | SCALE   | CURRENT REV DESC: GOLD LENGTH SPEC CHANGED AS MIN 2.54- MAX 5.54 FOR A-42375-0037/0071   |
| ▽ = 0   | MM/IN   | 1:1     | <br>KK 100 HEADER ASSY<br>FLAT VERTICAL BREAKAWAY |
| ▽ = 0   | GENERAL TOLERANCES (UNLESS SPECIFIED)   |         |  |
| ▽ = 0   |   |         | EC NO: 689596<br>DRWN: SHRUTJ 2021/09/14<br>CHK'D: SHRUTJ 2021/12/20<br>APPR: ISHWARG 2021/12/20                                       |
| ▽ = 0   | 4 PLACES ±  | ±       |  |
| ▽ = 0   | 3 PLACES ±  | ± 0.01  | PRODUCT CUSTOMER DRAWING<br>DOCUMENT NUMBER: SD-42375-001<br>DOC TYPE: PSD<br>DOC PART: 001<br>REVISION: V                             |
| ▽ = 0   | 2 PLACES ±  | ± 0.25  |  |
| ▽ = 0   | 1 PLACE ±   | ± 0.38  | INITIAL REVISION:<br>DRWN: SCHAFFER 2003/02/11<br>APPR: MARGULIS 2004/02/27  |
| ▽ = 0   | 0 PLACES ±  | ±       |  |
| ▽ = 0   | ANGULAR TOL ± 0.5°  |         | MATERIAL NUMBER: SEE CHART<br>CUSTOMER: GENERAL MARKET<br>SHEET NUMBER: 15 OF 35   |
| ▽ = 0   | DRAFT WHERE APPLICABLE MUST REMAIN WITHIN DIMENSIONS  |         |  |
| ▽ = 0   | THIRD ANGLE PROJECTION  | DRAWING | SERIES   |
| ▽ = 0   |    | B-SIZE  | 42375  |

|                 |    |              |            |          |
|-----------------|----|--------------|------------|----------|
| DOCUMENT STATUS | P1 | RELEASE DATE | 2021/12/20 | 12:18:33 |
|-----------------|----|--------------|------------|----------|

E

| ENG. NO: 42375-1720/1753 |             |                    |             |
|--------------------------|-------------|--------------------|-------------|
| HEADER NUMBER:           |             | 42312-0036         |             |
| PIN NUMBER:              |             | 42663-ABB208       |             |
| PIN LENGTH: L            |             | .455 / 11.56       |             |
| MATING LENGTH: M         |             | .240 / 6.09        |             |
| GOLD POINT: G            |             | .140 / 3.56        |             |
| PC TAIL LENGTH: P        |             | .125 / 3.18        |             |
| TIN: T                   |             | .100 / 2.54        |             |
| CKTS:                    |             | 3-36               |             |
| KINKS:                   |             | NO                 |             |
| VOIDED CKTS:             |             | 3                  |             |
| PACKAGING:               |             | BULK PK-40873-0041 |             |
| CKTS                     | ITEM NUMBER | CKTS               | ITEM NUMBER |
| 2                        |             | 20                 | 42375-1737  |
| 3                        | 42375-1720  | 21                 | 42375-1738  |
| 4                        | 42375-1721  | 22                 | 42375-1739  |
| 5                        | 42375-1722  | 23                 | 42375-1740  |
| 6                        | 42375-1723  | 24                 | 42375-1741  |
| 7                        | 42375-1724  | 25                 | 42375-1742  |
| 8                        | 42375-1725  | 26                 | 42375-1743  |
| 9                        | 42375-1726  | 27                 | 42375-1744  |
| 10                       | 42375-1727  | 28                 | 42375-1745  |
| 11                       | 42375-1728  | 29                 | 42375-1746  |
| 12                       | 42375-1729  | 30                 | 42375-1747  |
| 13                       | 42375-1730  | 31                 | 42375-1748  |
| 14                       | 42375-1731  | 32                 | 42375-1749  |
| 15                       | 42375-1732  | 33                 | 42375-1750  |
| 16                       | 42375-1733  | 34                 | 42375-1751  |
| 17                       | 42375-1734  | 35                 | 42375-1752  |
| 18                       | 42375-1735  | 36                 | 42375-1753  |
| 19                       | 42375-1736  |                    |             |

| ENG. NO: 42375-1855/1889 |             |                    |             |
|--------------------------|-------------|--------------------|-------------|
| HEADER NUMBER:           |             | 42312-0036         |             |
| PIN NUMBER:              |             | 42663-CJA154       |             |
| PIN LENGTH: L            |             | .700 / 17.78       |             |
| MATING LENGTH: M         |             | .488 / 12.40       |             |
| GOLD POINT: G            |             | N/A                |             |
| PC TAIL LENGTH: P        |             | .122 / 3.10        |             |
| TIN: T                   |             | OVERALL            |             |
| CKTS:                    |             | 2-36               |             |
| KINKS:                   |             | NO                 |             |
| VOIDED CKTS:             |             | NONE               |             |
| PACKAGING:               |             | BULK PK-40873-0041 |             |
| CKTS                     | ITEM NUMBER | CKTS               | ITEM NUMBER |
| 2                        | 42375-1855  | 20                 | 42375-1873  |
| 3                        | 42375-1856  | 21                 | 42375-1874  |
| 4                        | 42375-1857  | 22                 | 42375-1875  |
| 5                        | 42375-1858  | 23                 | 42375-1876  |
| 6                        | 42375-1859  | 24                 | 42375-1877  |
| 7                        | 42375-1860  | 25                 | 42375-1878  |
| 8                        | 42375-1861  | 26                 | 42375-1879  |
| 9                        | 42375-1862  | 27                 | 42375-1880  |
| 10                       | 42375-1863  | 28                 | 42375-1881  |
| 11                       | 42375-1864  | 29                 | 42375-1882  |
| 12                       | 42375-1865  | 30                 | 42375-1883  |
| 13                       | 42375-1866  | 31                 | 42375-1884  |
| 14                       | 42375-1867  | 32                 | 42375-1885  |
| 15                       | 42375-1868  | 33                 | 42375-1886  |
| 16                       | 42375-1869  | 34                 | 42375-1887  |
| 17                       | 42375-1870  | 35                 | 42375-1888  |
| 18                       | 42375-1871  | 36                 | 42375-1889  |
| 19                       | 42375-1872  |                    |             |

D

C

B

A

|   |  |  |   |
|---|--|--|---|
| <b>SYMBOLS</b><br>DIMENSION UNITS: <b>MM/IN</b><br>SCALE: <b>1:1</b><br>GENERAL TOLERANCES (UNLESS SPECIFIED)<br>4 PLACES ±<br>3 PLACES ±<br>2 PLACES ± 0.25 ±<br>1 PLACE ± 0.38 ±<br>0 PLACES ±<br>ANGULAR TOL ± 0.5°<br>DRAFT WHERE APPLICABLE MUST REMAIN WITHIN DIMENSIONS<br>THIRD ANGLE PROJECTION<br>DRAWING SERIES: <b>B-SIZE 42375</b> | THIS DRAWING CONTAINS INFORMATION THAT IS PROPRIETARY TO MOLEX ELECTRONIC TECHNOLOGIES, LLC AND SHOULD NOT BE USED WITHOUT WRITTEN PERMISSION<br>CURRENT REV DESC: GOLD LENGTH SPEC CHANGED AS MIN 2.54- MAX 5.54 FOR A-42375-0037/0071<br>EC NO: 689596<br>DRWN: SHRUTJ 2021/09/14<br>CHK'D: SHRUTJ 2021/12/20<br>APPR: ISHWARG 2021/12/20<br>INITIAL REVISION:<br>DRWN: SCHAFFER 2003/02/11<br>APPR: MARGULIS 2004/02/27 |  | <br>KK 100 HEADER ASSY<br>FLAT VERTICAL BREAKAWAY<br>PRODUCT CUSTOMER DRAWING<br>DOCUMENT NUMBER: <b>SD-42375-001</b><br>DOC TYPE: PSD<br>DOC PART: 001<br>REVISION: V<br>MATERIAL NUMBER: SEE CHART<br>CUSTOMER: GENERAL MARKET<br>SHEET NUMBER: 16 OF 35 |
|   | DOCUMENT STATUS: P1   RELEASE DATE: 2021/12/20 12:18:33  |  |   |
|   | DIMENSION UNITS: MM/IN   SCALE: 1:1  |  |   |
|   | GENERAL TOLERANCES (UNLESS SPECIFIED)  |  |   |



E

E

| ENG. NO: 42375-1922/1956 |             |                    |             |
|--------------------------|-------------|--------------------|-------------|
| HEADER NUMBER:           |             | 42312-0036         |             |
| PIN NUMBER:              |             | 42663-AEA154       |             |
| PIN LENGTH: L            |             | .700 / 17.78       |             |
| MATING LENGTH: M         |             | .190 / 4.83        |             |
| GOLD POINT: G            |             | N/A                |             |
| PC TAIL LENGTH: P        |             | .190 / 4.83        |             |
| TIN: T                   |             | .200 / 5.08        |             |
| CKTS:                    |             | 2-36               |             |
| KINKS:                   |             | NO                 |             |
| VOIDED CKTS:             |             | NONE               |             |
| PACKAGING:               |             | BULK PK-40873-0041 |             |
| CKTS                     | ITEM NUMBER | CKTS               | ITEM NUMBER |
| 2                        | 42375-1922  | 20                 | 42375-1873  |
| 3                        | 42375-1923  | 21                 | 42375-1874  |
| 4                        | 42375-1924  | 22                 | 42375-1875  |
| 5                        | 42375-1925  | 23                 | 42375-1876  |
| 6                        | 42375-1926  | 24                 | 42375-1877  |
| 7                        | 42375-1927  | 25                 | 42375-1878  |
| 8                        | 42375-1928  | 26                 | 42375-1879  |
| 9                        | 42375-1929  | 27                 | 42375-1880  |
| 10                       | 42375-1930  | 28                 | 42375-1881  |
| 11                       | 42375-1931  | 29                 | 42375-1882  |
| 12                       | 42375-1932  | 30                 | 42375-1883  |
| 13                       | 42375-1933  | 31                 | 42375-1884  |
| 14                       | 42375-1934  | 32                 | 42375-1885  |
| 15                       | 42375-1935  | 33                 | 42375-1886  |
| 16                       | 42375-1936  | 34                 | 42375-1887  |
| 17                       | 42375-1937  | 35                 | 42375-1888  |
| 18                       | 42375-1938  | 36                 | 42375-1889  |
| 19                       | 42375-1939  |                    |             |

| ENG. NO: 42375-2246/2275 |             |                    |             |
|--------------------------|-------------|--------------------|-------------|
| HEADER NUMBER:           |             | 42312-0036         |             |
| PIN NUMBER:              |             | 42663-ABA154       |             |
| PIN LENGTH: L            |             | .455 / 11.56       |             |
| MATING LENGTH: M         |             | .240 / 6.09        |             |
| GOLD POINT: G            |             | N/A                |             |
| PC TAIL LENGTH: P        |             | .125 / 3.18        |             |
| TIN: T                   |             | OVERALL            |             |
| CKTS:                    |             | 7-36               |             |
| KINKS:                   |             | NO                 |             |
| VOIDED CKTS:             |             | 2,7                |             |
| PACKAGING:               |             | BULK PK-40873-0041 |             |
| CKTS                     | ITEM NUMBER | CKTS               | ITEM NUMBER |
| 2                        |             | 20                 | 42375-2259  |
| 3                        |             | 21                 | 42375-2260  |
| 4                        |             | 22                 | 42375-2261  |
| 5                        |             | 23                 | 42375-2262  |
| 6                        |             | 24                 | 42375-2263  |
| 7                        | 42375-2246  | 25                 | 42375-2264  |
| 8                        | 42375-2247  | 26                 | 42375-2265  |
| 9                        | 42375-2248  | 27                 | 42375-2266  |
| 10                       | 42375-2249  | 28                 | 42375-2267  |
| 11                       | 42375-2250  | 29                 | 42375-2268  |
| 12                       | 42375-2251  | 30                 | 42375-2269  |
| 13                       | 42375-2252  | 31                 | 42375-2270  |
| 14                       | 42375-2253  | 32                 | 42375-2271  |
| 15                       | 42375-2254  | 33                 | 42375-2272  |
| 16                       | 42375-2255  | 34                 | 42375-2273  |
| 17                       | 42375-2256  | 35                 | 42375-2274  |
| 18                       | 42375-2257  | 36                 | 42375-2275  |
| 19                       | 42375-2258  |                    |             |

D

D

C

C

B

B

A

A

|  |  |  |  |
|--|--|--|--|
| <b>SYMBOLS</b><br>DIMENSION UNITS: <b>MM/IN</b><br>SCALE: <b>1:1</b><br>GENERAL TOLERANCES (UNLESS SPECIFIED)<br>4 PLACES ± 0.125 ± 0.01<br>3 PLACES ± 0.25 ± 0.01<br>2 PLACES ± 0.25 ± 0.01<br>1 PLACE ± 0.38 ± 0.01<br>0 PLACES ± 0.38 ± 0.01<br>ANGULAR TOL ± 0.5°<br>DRAFT WHERE APPLICABLE MUST REMAIN WITHIN DIMENSIONS<br>THIRD ANGLE PROJECTION<br>DRAWING SERIES: <b>B-SIZE 42375</b> | THIS DRAWING CONTAINS INFORMATION THAT IS PROPRIETARY TO MOLEX ELECTRONIC TECHNOLOGIES, LLC AND SHOULD NOT BE USED WITHOUT WRITTEN PERMISSION<br>CURRENT REV DESC: GOLD LENGTH SPEC CHANGED AS MIN 2.54- MAX 5.54 FOR A-42375-0037/0071<br>EC NO: 689596<br>DRWN: SHRUTJ 2021/09/14<br>CHK'D: SHRUTJ 2021/12/20<br>APPR: ISHWARG 2021/12/20<br>INITIAL REVISION:<br>DRWN: SCHAFFER 2003/02/11<br>APPR: MARGULIS 2004/02/27 |  | <br>KK 100 HEADER ASSY<br>FLAT VERTICAL BREAKAWAY |
|  | PRODUCT CUSTOMER DRAWING<br>DOCUMENT NUMBER: <b>SD-42375-001</b><br>DOC TYPE: PSD<br>DOC PART: 001<br>REVISION: V  |  |  |
|  | MATERIAL NUMBER: SEE CHART<br>CUSTOMER: GENERAL MARKET<br>SHEET NUMBER: 17 OF 35   |  |  |

E

E

| ENG. NO: 42375-2486/2520 |             |                    |             |
|--------------------------|-------------|--------------------|-------------|
| HEADER NUMBER:           |             | 42312-0036         |             |
| PIN NUMBER:              |             | 42663-AFB208       |             |
| PIN LENGTH: L            |             | .475 / 12.07       |             |
| MATING LENGTH: M         |             | .232 / 5.89        |             |
| GOLD POINT: G            |             | .150 / 3.81        |             |
| PC TAIL LENGTH: P        |             | .153 / 3.89        |             |
| TIN: T                   |             | .100 / 2.54        |             |
| CKTS:                    |             | 2-36               |             |
| KINKS:                   |             | NO                 |             |
| VOIDED CKTS:             |             | NONE               |             |
| PACKAGING:               |             | BULK PK-40873-0041 |             |
| CKTS                     | ITEM NUMBER | CKTS               | ITEM NUMBER |
| 2                        | 42375-2486  | 19                 | 42375-2503  |
| 3                        | 42375-2487  | 20                 | 42375-2504  |
|                          | 68300-2008  | 21                 | 42375-2505  |
| 4                        | 42375-2488  | 22                 | 42375-2506  |
| 5                        | 42375-2489  | 23                 | 42375-2507  |
| 6                        | 42375-2490  | 24                 | 42375-2508  |
| 7                        | 42375-2491  | 25                 | 42375-2509  |
| 8                        | 42375-2492  | 26                 | 42375-2510  |
| 9                        | 42375-2493  | 27                 | 42375-2511  |
| 10                       | 42375-2494  | 28                 | 42375-2512  |
| 11                       | 42375-2495  | 29                 | 42375-2513  |
| 12                       | 42375-2496  | 30                 | 42375-2514  |
| 13                       | 42375-2497  | 31                 | 42375-2515  |
| 14                       | 42375-2498  | 32                 | 42375-2516  |
| 15                       | 42375-2499  | 33                 | 42375-2517  |
| 16                       | 42375-2500  | 34                 | 42375-2518  |
| 17                       | 42375-2501  | 35                 | 42375-2519  |
| 18                       | 42375-2502  | 36                 | 42375-2520  |

| ENG. NO: 42375-2521/2555 |             |                    |             |
|--------------------------|-------------|--------------------|-------------|
| HEADER NUMBER:           |             | 42312-0036         |             |
| PIN NUMBER:              |             | 42663-AFB228       |             |
| PIN LENGTH: L            |             | .475 / 12.07       |             |
| MATING LENGTH: M         |             | .232 / 5.89        |             |
| GOLD POINT: G            |             | .150 / 3.81        |             |
| PC TAIL LENGTH: P        |             | .153 / 3.89        |             |
| TIN: T                   |             | .100 / 2.54        |             |
| CKTS:                    |             | 2-36               |             |
| KINKS:                   |             | NO                 |             |
| VOIDED CKTS:             |             | NONE               |             |
| PACKAGING:               |             | BULK PK-40873-0041 |             |
| CKTS                     | ITEM NUMBER | CKTS               | ITEM NUMBER |
| 2                        | 42375-2521  | 20                 | 42375-2539  |
| 3                        | 42375-2522  | 21                 | 42375-2540  |
| 4                        | 42375-2523  | 22                 | 42375-2541  |
| 5                        | 42375-2524  | 23                 | 42375-2542  |
| 6                        | 42375-2525  | 24                 | 42375-2543  |
| 7                        | 42375-2526  | 25                 | 42375-2544  |
| 8                        | 42375-2527  | 26                 | 42375-2545  |
| 9                        | 42375-2528  | 27                 | 42375-2546  |
| 10                       | 42375-2529  | 28                 | 42375-2547  |
| 11                       | 42375-2530  | 29                 | 42375-2548  |
| 12                       | 42375-2531  | 30                 | 42375-2549  |
| 13                       | 42375-2532  | 31                 | 42375-2550  |
| 14                       | 42375-2533  | 32                 | 42375-2551  |
| 15                       | 42375-2534  | 33                 | 42375-2552  |
| 16                       | 42375-2535  | 34                 | 42375-2553  |
| 17                       | 42375-2536  | 35                 | 42375-2554  |
| 18                       | 42375-2537  | 36                 | 42375-2555  |
| 19                       | 42375-2539  |                    |             |

D

D

C

C

B

B

A

A

|         |   |         |  |
|---------|---|---------|--|
| SYMBOLS | THIS DRAWING CONTAINS INFORMATION THAT IS PROPRIETARY TO MOLEX ELECTRONIC TECHNOLOGIES, LLC AND SHOULD NOT BE USED WITHOUT WRITTEN PERMISSION |         |  |
|         | DIMENSION UNITS   | SCALE   | CURRENT REV DESC: GOLD LENGTH SPEC CHANGED AS MIN 2.54- MAX 5.54 FOR A-42375-0037/0071   |
| ▽ = 0   | MM/IN   | 1:1     | <br>KK 100 HEADER ASSY<br>FLAT VERTICAL BREAKAWAY |
| ▽ = 0   | GENERAL TOLERANCES (UNLESS SPECIFIED)   |         |  |
| ▽ = 0   |   |         | EC NO: 689596<br>DRWN: SHRUTJ 2021/09/14<br>CHK'D: SHRUTJ 2021/12/20<br>APPR: ISHWARG 2021/12/20                                       |
| ▽ = 0   | 4 PLACES ±  | ±       |  |
| ▽ = 0   | 3 PLACES ±  | ± 0.01  | PRODUCT CUSTOMER DRAWING<br>DOCUMENT NUMBER: SD-42375-001<br>DOC TYPE: PSD<br>DOC PART: 001<br>REVISION: V                             |
| ▽ = 0   | 2 PLACES ±  | ± 0.25  |  |
| ▽ = 0   | 1 PLACE ±   | ± 0.38  | INITIAL REVISION:<br>DRWN: SCHAFFER 2003/02/11<br>APPR: MARGULIS 2004/02/27  |
| ▽ = 0   | 0 PLACES ±  | ±       |  |
| ▽ = 0   | ANGULAR TOL ± 0.5°  |         | MATERIAL NUMBER: SEE CHART<br>CUSTOMER: GENERAL MARKET<br>SHEET NUMBER: 18 OF 35   |
| ▽ = 0   | DRAFT WHERE APPLICABLE MUST REMAIN WITHIN DIMENSIONS  |         |  |
| ▽ = 0   | THIRD ANGLE PROJECTION  | DRAWING | SERIES   |
|         |    | B-SIZE  | 42375  |

|                 |    |              |            |          |
|-----------------|----|--------------|------------|----------|
| DOCUMENT STATUS | P1 | RELEASE DATE | 2021/12/20 | 12:18:33 |
|-----------------|----|--------------|------------|----------|

E

E

| ENG. NO: 42375-2801/2835 |             |                    |             |
|--------------------------|-------------|--------------------|-------------|
| HEADER NUMBER:           |             | 42312-0036         |             |
| PIN NUMBER:              |             | 42663-HDB228       |             |
| PIN LENGTH: L            |             | 1.200 / 30.48      |             |
| MATING LENGTH: M         |             | 1.000 / 25.40      |             |
| GOLD POINT: G            |             | .200 / 5.08        |             |
| PC TAIL LENGTH: P        |             | .110 / 2.79        |             |
| TIN: T                   |             | .200 / 5.08        |             |
| CKTS:                    |             | 2-36               |             |
| KINKS:                   |             | NO                 |             |
| VOIDED CKTS:             |             | NONE               |             |
| PACKAGING:               |             | BULK PK-40873-0043 |             |
| CKTS                     | ITEM NUMBER | CKTS               | ITEM NUMBER |
| 2                        | 42375-2801  | 20                 | 42375-2819  |
| 3                        | 42375-2802  | 21                 | 42375-2820  |
| 4                        | 42375-2803  | 22                 | 42375-2821  |
| 5                        | 42375-2804  | 23                 | 42375-2822  |
| 6                        | 42375-2805  | 24                 | 42375-2823  |
| 7                        | 42375-2806  | 25                 | 42375-2824  |
| 8                        | 42375-2807  | 26                 | 42375-2825  |
| 9                        | 42375-2808  | 27                 | 42375-2826  |
| 10                       | 42375-2809  | 28                 | 42375-2827  |
| 11                       | 42375-2810  | 29                 | 42375-2828  |
| 12                       | 42375-2811  | 30                 | 42375-2829  |
| 13                       | 42375-2812  | 31                 | 42375-2830  |
| 14                       | 42375-2813  | 32                 | 42375-2831  |
| 15                       | 42375-2814  | 33                 | 42375-2832  |
| 16                       | 42375-2815  | 34                 | 42375-2833  |
| 17                       | 42375-2816  | 35                 | 42375-2834  |
| 18                       | 42375-2817  | 36                 | 42375-2835  |
| 19                       | 42375-2818  |                    |             |

| ENG. NO: 42375-2836/2870 |             |                    |             |
|--------------------------|-------------|--------------------|-------------|
| HEADER NUMBER:           |             | 42312-0036         |             |
| PIN NUMBER:              |             | 42663-EMA154       |             |
| PIN LENGTH: L            |             | .925 / 23.50       |             |
| MATING LENGTH: M         |             | .625 / 15.88       |             |
| GOLD POINT: G            |             | N/A                |             |
| PC TAIL LENGTH: P        |             | .210 / 5.33        |             |
| TIN: T                   |             | OVERALL            |             |
| CKTS:                    |             | 2-36               |             |
| KINKS:                   |             | NO                 |             |
| VOIDED CKTS:             |             | NONE               |             |
| PACKAGING:               |             | BULK PK-40873-0041 |             |
| CKTS                     | ITEM NUMBER | CKTS               | ITEM NUMBER |
| 2                        | 42375-2836  | 20                 | 42375-2854  |
| 3                        | 42375-2837  | 21                 | 42375-2855  |
| 4                        | 42375-2838  | 22                 | 42375-2856  |
| 5                        | 42375-2839  | 23                 | 42375-2857  |
| 6                        | 42375-2840  | 24                 | 42375-2858  |
| 7                        | 42375-2841  | 25                 | 42375-2859  |
| 8                        | 42375-2842  | 26                 | 42375-2860  |
| 9                        | 42375-2843  | 27                 | 42375-2861  |
| 10                       | 42375-2844  | 28                 | 42375-2862  |
| 11                       | 42375-2845  | 29                 | 42375-2863  |
| 12                       | 42375-2846  | 30                 | 42375-2864  |
| 13                       | 42375-2847  | 31                 | 42375-2865  |
| 14                       | 42375-2848  | 32                 | 42375-2866  |
| 15                       | 42375-2849  | 33                 | 42375-2867  |
| 16                       | 42375-2850  | 34                 | 42375-2868  |
| 17                       | 42375-2851  | 35                 | 42375-2869  |
| 18                       | 42375-2852  | 36                 | 42375-2870  |
| 19                       | 42375-2853  |                    |             |

D

D

C

C

B

B



A

A

|  |   |  |  |  |  |  |   |  |   |  |
|--|---|--|--|--|--|--|---|--|---|--|
| <b>SYMBOLS</b><br>▽ = 0<br>▽ = 0<br>▽ = 0<br>▽ = 0<br>▽ = 0<br>▽ = 0<br>▽ = 0<br>▽ = 0<br>▽ = 0<br>▽ = 0 | THIS DRAWING CONTAINS INFORMATION THAT IS PROPRIETARY TO MOLEX ELECTRONIC TECHNOLOGIES, LLC AND SHOULD NOT BE USED WITHOUT WRITTEN PERMISSION |  | DIMENSION UNITS: <b>MM/IN</b><br>SCALE: <b>1:1</b> |  | CURRENT REV DESC: GOLD LENGTH SPEC CHANGED AS MIN 2.54- MAX 5.54 FOR A-42375-0037/0071           |  |  |  |   |  |
|  | GENERAL TOLERANCES (UNLESS SPECIFIED)   |  |  |  | EC NO: 689596<br>DRWN: SHRUTJ 2021/09/14<br>CHK'D: SHRUTJ 2021/12/20<br>APPR: ISHWARG 2021/12/20 |  |   |  | KK 100 HEADER ASSY<br>FLAT VERTICAL BREAKAWAY   |  |
|  | 4 PLACES ± 0.25 ±<br>3 PLACES ± 0.25 ±<br>2 PLACES ± 0.25 ±<br>1 PLACE ± 0.38 ±<br>0 PLACES ± 0.38 ±  |  |  |  | INITIAL REVISION:<br>DRWN: SCHAFFER 2003/02/11<br>APPR: MARGULIS 2004/02/27                      |  | PRODUCT CUSTOMER DRAWING  |  |   |  |
|  | ANGULAR TOL ± 0.5°  |  |  |  | DRAFT WHERE APPLICABLE MUST REMAIN WITHIN DIMENSIONS   |  | THIRD ANGLE PROJECTION  |  | DOCUMENT NUMBER: <b>SD-42375-001</b><br>DOC TYPE: PSD<br>DOC PART: 001<br>REVISION: V |  |
|  | DRAFT WHERE APPLICABLE MUST REMAIN WITHIN DIMENSIONS  |  |  |  | DRIVING  |  | SERIES: <b>42375</b>  |  | MATERIAL NUMBER: SEE CHART<br>CUSTOMER: GENERAL MARKET<br>SHEET NUMBER: 19 OF 35      |  |
|  | DRAFT WHERE APPLICABLE MUST REMAIN WITHIN DIMENSIONS  |  |  |  | B-SIZE   |  | SEE CHART   |  | GENERAL MARKET  |  |
|  | DRAFT WHERE APPLICABLE MUST REMAIN WITHIN DIMENSIONS  |  |  |  | B-SIZE   |  | SEE CHART   |  | GENERAL MARKET  |  |
|  | DRAFT WHERE APPLICABLE MUST REMAIN WITHIN DIMENSIONS  |  |  |  | B-SIZE   |  | SEE CHART   |  | GENERAL MARKET  |  |
|  | DRAFT WHERE APPLICABLE MUST REMAIN WITHIN DIMENSIONS  |  |  |  | B-SIZE   |  | SEE CHART   |  | GENERAL MARKET  |  |
|  | DRAFT WHERE APPLICABLE MUST REMAIN WITHIN DIMENSIONS  |  |  |  | B-SIZE   |  | SEE CHART   |  | GENERAL MARKET  |  |

| ENG. NO: 42375-3044/3078 |             |                    |             |
|--------------------------|-------------|--------------------|-------------|
| HEADER NUMBER:           |             | 42312-0036         |             |
| PIN NUMBER:              |             | 42663-KHB208       |             |
| PIN LENGTH: L            |             | 1.430 / 36.32      |             |
| MATING LENGTH: M         |             | .867 / 22.02       |             |
| GOLD POINT: G            |             | .200 / 5.08        |             |
| PC TAIL LENGTH: P        |             | .473 / 12.01       |             |
| TIN: T                   |             | .200 / 5.08        |             |
| CKTS:                    |             | 2-36               |             |
| KINKS:                   |             | NO                 |             |
| VOIDED CKTS:             |             | NONE               |             |
| PACKAGING:               |             | BULK PK-40873-0043 |             |
| CKTS                     | ITEM NUMBER | CKTS               | ITEM NUMBER |
| 2                        | 42375-3044  | 20                 | 42375-3062  |
| 3                        | 42375-3045  | 21                 | 42375-3063  |
| 4                        | 42375-3046  | 22                 | 42375-3064  |
| 5                        | 42375-3047  | 23                 | 42375-3065  |
| 6                        | 42375-3048  | 24                 | 42375-3066  |
| 7                        | 42375-3049  | 25                 | 42375-3067  |
| 8                        | 42375-3050  | 26                 | 42375-3068  |
| 9                        | 42375-3051  | 27                 | 42375-3069  |
| 10                       | 42375-3052  | 28                 | 42375-3070  |
| 11                       | 42375-3053  | 29                 | 42375-3071  |
| 12                       | 42375-3054  | 30                 | 42375-3072  |
| 13                       | 42375-3055  | 31                 | 42375-3073  |
| 14                       | 42375-3056  | 32                 | 42375-3074  |
| 15                       | 42375-3057  | 33                 | 42375-3075  |
| 16                       | 42375-3058  | 34                 | 42375-3076  |
| 17                       | 42375-3059  | 35                 | 42375-3077  |
| 18                       | 42375-3060  | 36                 | 42375-3078  |
| 19                       | 42375-3061  |                    |             |

| ENG. NO: 42375-3114/3148 |             |                    |             |
|--------------------------|-------------|--------------------|-------------|
| HEADER NUMBER:           |             | 42312-0036         |             |
| PIN NUMBER:              |             | 42663-BXA154       |             |
| PIN LENGTH: L            |             | .645 / 16.38       |             |
| MATING LENGTH: M         |             | .431 / 10.95       |             |
| GOLD POINT: G            |             | N/A                |             |
| PC TAIL LENGTH: P        |             | .124 / 3.15        |             |
| TIN: T                   |             | OVERALL            |             |
| CKTS:                    |             | 2-36               |             |
| KINKS:                   |             | NO                 |             |
| VOIDED CKTS:             |             | NONE               |             |
| PACKAGING:               |             | BULK PK-40873-0041 |             |
| CKTS                     | ITEM NUMBER | CKTS               | ITEM NUMBER |
| 2                        | 42375-3114  | 20                 | 42375-3132  |
| 3                        | 42375-3115  | 21                 | 42375-3133  |
| 4                        | 42375-3116  | 22                 | 42375-3134  |
| 5                        | 42375-3117  | 23                 | 42375-3135  |
| 6                        | 42375-3118  | 24                 | 42375-3136  |
| 7                        | 42375-3119  | 25                 | 42375-3137  |
| 8                        | 42375-3120  | 26                 | 42375-3138  |
| 9                        | 42375-3121  | 27                 | 42375-3139  |
| 10                       | 42375-3122  | 28                 | 42375-3140  |
| 11                       | 42375-3123  | 29                 | 42375-3141  |
| 12                       | 42375-3124  | 30                 | 42375-3142  |
| 13                       | 42375-3125  | 31                 | 42375-3143  |
| 14                       | 42375-3126  | 32                 | 42375-3144  |
| 15                       | 42375-3127  | 33                 | 42375-3145  |
| 16                       | 42375-3128  | 34                 | 42375-3146  |
| 17                       | 42375-3129  | 35                 | 42375-3147  |
| 18                       | 42375-3130  | 36                 | 42375-3148  |
| 19                       | 42375-3131  |                    |             |

|         |   |         |  |
|---------|---|---------|--|
| SYMBOLS | THIS DRAWING CONTAINS INFORMATION THAT IS PROPRIETARY TO MOLEX ELECTRONIC TECHNOLOGIES, LLC AND SHOULD NOT BE USED WITHOUT WRITTEN PERMISSION |         |  |
|         | DIMENSION UNITS   | SCALE   | CURRENT REV DESC: GOLD LENGTH SPEC CHANGED AS MIN 2.54- MAX 5.54 FOR A-42375-0037/0071   |
| ▽ = 0   | MM/IN   | 1:1     | <br>KK 100 HEADER ASSY<br>FLAT VERTICAL BREAKAWAY |
| ▽ = 0   | GENERAL TOLERANCES (UNLESS SPECIFIED)   |         |  |
| ▽ = 0   |   |         | EC NO: 689596<br>DRWN: SHRUTJ 2021/09/14<br>CHK'D: SHRUTJ 2021/12/20<br>APPR: ISHWARG 2021/12/20                                       |
| ▽ = 0   | 4 PLACES ±  | ±       |  |
| ▽ = 0   | 3 PLACES ±  | ± 0.01  | PRODUCT CUSTOMER DRAWING<br>DOCUMENT NUMBER: SD-42375-001<br>DOC TYPE: PSD<br>DOC PART: 001<br>REVISION: V                             |
| ▽ = 0   | 2 PLACES ±  | ± 0.25  |  |
| ▽ = 0   | 1 PLACE ±   | ± 0.38  | INITIAL REVISION:<br>DRWN: SCHAFFER 2003/02/11<br>APPR: MARGULIS 2004/02/27  |
| ▽ = 0   | 0 PLACES ±  | ±       |  |
| ▽ = 0   | ANGULAR TOL ± 0.5°  |         | MATERIAL NUMBER: SEE CHART<br>CUSTOMER: GENERAL MARKET<br>SHEET NUMBER: 20 OF 35   |
| ▽ = 0   | DRAFT WHERE APPLICABLE MUST REMAIN WITHIN DIMENSIONS  |         |  |
| ▽ = 0   | THIRD ANGLE PROJECTION  | DRAWING | SERIES   |
|         |    | B-SIZE  | 42375  |

| ENG. NO: 42375-3149 / 3183 |             |                    |             |
|----------------------------|-------------|--------------------|-------------|
| HEADER NUMBER:             |             | 42312-0036         |             |
| PIN NUMBER:                |             | 42663-BEB208       |             |
| PIN LENGTH: L              |             | .575 / 14.61       |             |
| MATING LENGTH: M           |             | .350 / 8.89        |             |
| GOLD POINT: G              |             | .200 / 5.08        |             |
| PC TAIL LENGTH: P          |             | .135 / 3.43        |             |
| TIN: T                     |             | .200 / 5.08        |             |
| CKTS:                      |             | 2-36               |             |
| KINKS:                     |             | NO                 |             |
| VOIDED CKTS:               |             | NONE               |             |
| PACKAGING:                 |             | BULK PK-40873-0041 |             |
| CKTS                       | ITEM NUMBER | CKTS               | ITEM NUMBER |
| 2                          | 42375-3149  | 20                 | 42375-3167  |
| 3                          | 42375-3150  | 21                 | 42375-3168  |
| 4                          | 42375-3151  | 22                 | 42375-3169  |
| 5                          | 42375-3152  | 23                 | 42375-3170  |
| 6                          | 42375-3153  | 24                 | 42375-3171  |
| 7                          | 42375-3154  | 25                 | 42375-3172  |
| 8                          | 42375-3155  | 26                 | 42375-3173  |
| 9                          | 42375-3156  | 27                 | 42375-3174  |
| 10                         | 42375-3157  | 28                 | 42375-3175  |
| 11                         | 42375-3158  | 29                 | 42375-3176  |
| 12                         | 42375-3159  | 30                 | 42375-3177  |
| 13                         | 42375-3160  | 31                 | 42375-3178  |
| 14                         | 42375-3161  | 32                 | 42375-3179  |
| 15                         | 42375-3162  | 33                 | 42375-3180  |
| 16                         | 42375-3163  | 34                 | 42375-3181  |
| 17                         | 42375-3164  | 35                 | 42375-3182  |
| 18                         | 42375-3165  | 36                 | 42375-3183  |
| 19                         | 42375-3166  |                    |             |

| ENG. NO: 42375-3184 / 3218 |             |                    |             |
|----------------------------|-------------|--------------------|-------------|
| HEADER NUMBER:             |             | 42312-0036         |             |
| PIN NUMBER:                |             | 42663-GNB208       |             |
| PIN LENGTH: L              |             | 1.140 / 28.96      |             |
| MATING LENGTH: M           |             | .913 / 23.20       |             |
| GOLD POINT: G              |             | .200 / 5.08        |             |
| PC TAIL LENGTH: P          |             | .137 / 3.48        |             |
| TIN: T                     |             | .200 / 5.08        |             |
| CKTS:                      |             | 2-36               |             |
| KINKS:                     |             | NO                 |             |
| VOIDED CKTS:               |             | NONE               |             |
| PACKAGING:                 |             | BULK PK-40873-0043 |             |
| CKTS                       | ITEM NUMBER | CKTS               | ITEM NUMBER |
| 2                          | 42375-3184  | 20                 | 42375-3202  |
| 3                          | 42375-3185  | 21                 | 42375-3203  |
| 4                          | 42375-3186  | 22                 | 42375-3204  |
| 5                          | 42375-3187  | 23                 | 42375-3205  |
| 6                          | 42375-3188  | 24                 | 42375-3206  |
| 7                          | 42375-3189  | 25                 | 42375-3207  |
| 8                          | 42375-3190  | 26                 | 42375-3208  |
| 9                          | 42375-3191  | 27                 | 42375-3209  |
| 10                         | 42375-3192  | 28                 | 42375-3210  |
| 11                         | 42375-3193  | 29                 | 42375-3211  |
| 12                         | 42375-3194  | 30                 | 42375-3212  |
| 13                         | 42375-3195  | 31                 | 42375-3213  |
| 14                         | 42375-3196  | 32                 | 42375-3214  |
| 15                         | 42375-3197  | 33                 | 42375-3215  |
| 16                         | 42375-3198  | 34                 | 42375-3216  |
| 17                         | 42375-3199  | 35                 | 42375-3217  |
| 18                         | 42375-3200  | 36                 | 42375-3218  |
| 19                         | 42375-3201  |                    |             |

| ENG. NO: 42375-3219 / 3253 |             |                    |             |
|----------------------------|-------------|--------------------|-------------|
| HEADER NUMBER:             |             | 42312-0036         |             |
| PIN NUMBER:                |             | 42663-BPA154       |             |
| PIN LENGTH: L              |             | .620 / 15.75       |             |
| MATING LENGTH: M           |             | .280 / 7.11        |             |
| GOLD POINT: G              |             | NA                 |             |
| PC TAIL LENGTH: P          |             | .250 / 6.35        |             |
| TIN: T                     |             | OVERALL            |             |
| CKTS:                      |             | 2-36               |             |
| KINKS:                     |             | NO                 |             |
| VOIDED CKTS:               |             | NONE               |             |
| PACKAGING:                 |             | BULK PK-40873-0041 |             |
| CKTS                       | ITEM NUMBER | CKTS               | ITEM NUMBER |
| 2                          | 42375-3219  | 20                 | 42375-3237  |
| 3                          | 42375-3220  | 21                 | 42375-3238  |
| 4                          | 42375-3221  | 22                 | 42375-3239  |
| 5                          | 42375-3222  | 23                 | 42375-3240  |
| 6                          | 42375-3223  | 24                 | 42375-3241  |
| 7                          | 42375-3224  | 25                 | 42375-3242  |
| 8                          | 42375-3225  | 26                 | 42375-3243  |
| 9                          | 42375-3226  | 27                 | 42375-3244  |
| 10                         | 42375-3227  | 28                 | 42375-3245  |
| 11                         | 42375-3228  | 29                 | 42375-3246  |
| 12                         | 42375-3229  | 30                 | 42375-3247  |
| 13                         | 42375-3230  | 31                 | 42375-3248  |
| 14                         | 42375-3231  | 32                 | 42375-3249  |
| 15                         | 42375-3232  | 33                 | 42375-3250  |
| 16                         | 42375-3233  | 34                 | 42375-3251  |
| 17                         | 42375-3234  | 35                 | 42375-3252  |
| 18                         | 42375-3235  | 36                 | 42375-3253  |
| 19                         | 42375-3236  |                    |             |

|   |   |  |   |  |  |  |                   |                 |                              |                            |                          |
|---|---|--|---|--|--|--|-------------------|-----------------|------------------------------|----------------------------|--------------------------|
| <b>SYMBOLS</b><br>= 0<br>= 0<br>= 0<br>= 0<br>= 0<br>= 0<br>= 0<br>= 0<br>= 0 | THIS DRAWING CONTAINS INFORMATION THAT IS PROPRIETARY TO MOLEX ELECTRONIC TECHNOLOGIES, LLC AND SHOULD NOT BE USED WITHOUT WRITTEN PERMISSION |  | <b>mm/in</b> <b>1:1</b>   |  | CURRENT REV DESC: GOLD LENGTH SPEC<br>CHANGED AS MIN 2.54- MAX 5.54 FOR<br>A-42375-0037/0071 |  |                   |                 |                              |                            |                          |
|   | GENERAL TOLERANCES<br>(UNLESS SPECIFIED)  |  | EC NO: 689596<br>DRWN: SHRUTJ      2021/09/14<br>CHK'D: SHRUTJ      2021/12/20<br>APPR: ISHWARG      2021/12/20 |  | PRODUCT CUSTOMER DRAWING   |  |                   |                 |                              |                            |                          |
|   | 4 PLACES ±      ±<br>3 PLACES ±      ± 0.01<br>2 PLACES ± 0.25 ±<br>1 PLACE ± 0.38 ±<br>0 PLACES ±      ±                                     |  | INITIAL REVISION:<br>DRWN: SCHAFFER      2003/02/11<br>APPR: MARGULIS      2004/02/27                           |  | DOCUMENT NUMBER<br><b>SD-42375-001</b>   |  | DOC TYPE<br>PSD   | DOC PART<br>001 | REVISION<br>V                |                            |                          |
|   | ANGULAR TOL ± 0.5°  |  | DRAFT WHERE APPLICABLE<br>MUST REMAIN<br>WITHIN DIMENSIONS  |  | THIRD ANGLE PROJECTION<br>   |  | DRAWING<br>B-SIZE | SERIES<br>42375 | MATERIAL NUMBER<br>SEE CHART | CUSTOMER<br>GENERAL MARKET | SHEET NUMBER<br>21 OF 35 |
|   | DOCUMENT STATUS    P1    RELEASE DATE    2021/12/20    12:18:33   |  |   |  |  |  |                   |                 |                              |                            |                          |

| ENG. NO: 42375-3254 / 3288 |                    |      |             |
|----------------------------|--------------------|------|-------------|
| HEADER NUMBER:             | 42312-0036         |      |             |
| PIN NUMBER:                | 42663-DMA154       |      |             |
| PIN LENGTH: L              | .820 / 20.83       |      |             |
| MATING LENGTH: M           | .590 / 14.99       |      |             |
| GOLD POINT: G              | NA                 |      |             |
| PC TAIL LENGTH: P          | .140 / 3.56        |      |             |
| TIN: T                     | OVERALL            |      |             |
| CKTS:                      | 2-36               |      |             |
| KINKS:                     | NO                 |      |             |
| VOIDED CKTS:               | NONE               |      |             |
| PACKAGING:                 | BULK PK-40873-0041 |      |             |
| CKTS                       | ITEM NUMBER        | CKTS | ITEM NUMBER |
| 2                          | 42375-3254         | 20   | 42375-3272  |
| 3                          | 42375-3255         | 21   | 42375-3273  |
| 4                          | 42375-3256         | 22   | 42375-3274  |
| 5                          | 42375-3257         | 23   | 42375-3275  |
| 6                          | 42375-3258         | 24   | 42375-3276  |
| 7                          | 42375-3259         | 25   | 42375-3277  |
| 8                          | 42375-3260         | 26   | 42375-3278  |
| 9                          | 42375-3261         | 27   | 42375-3279  |
| 10                         | 42375-3262         | 28   | 42375-3280  |
| 11                         | 42375-3263         | 29   | 42375-3281  |
| 12                         | 42375-3264         | 30   | 42375-3282  |
| 13                         | 42375-3265         | 31   | 42375-3283  |
| 14                         | 42375-3266         | 32   | 42375-3284  |
| 15                         | 42375-3267         | 33   | 42375-3285  |
| 16                         | 42375-3268         | 34   | 42375-3286  |
| 17                         | 42375-3269         | 35   | 42375-3287  |
| 18                         | 42375-3270         | 36   | 42375-3288  |
| 19                         | 42375-3271         |      |             |

| ENG. NO: 42375-3289 / 3323 |                    |      |             |
|----------------------------|--------------------|------|-------------|
| HEADER NUMBER:             | 42312-0036         |      |             |
| PIN NUMBER:                | 42663-FNA154       |      |             |
| PIN LENGTH: L              | 1.035 / 26.29      |      |             |
| MATING LENGTH: M           | .358 / 9.09        |      |             |
| GOLD POINT: G              | NA                 |      |             |
| PC TAIL LENGTH: P          | .587 / 14.91       |      |             |
| TIN: T                     | OVERALL            |      |             |
| CKTS:                      | 2-36               |      |             |
| KINKS:                     | NO                 |      |             |
| VOIDED CKTS:               | NONE               |      |             |
| PACKAGING:                 | BULK PK-40873-0043 |      |             |
| CKTS                       | ITEM NUMBER        | CKTS | ITEM NUMBER |
| 2                          | 42375-3289         | 20   | 42375-3307  |
| 3                          | 42375-3290         | 21   | 42375-3308  |
| 4                          | 42375-3291         | 22   | 42375-3309  |
| 5                          | 42375-3292         | 23   | 42375-3310  |
| 6                          | 42375-3293         | 24   | 42375-3311  |
| 7                          | 42375-3294         | 25   | 42375-3312  |
| 8                          | 42375-3295         | 26   | 42375-3313  |
| 9                          | 42375-3296         | 27   | 42375-3314  |
| 10                         | 42375-3297         | 28   | 42375-3315  |
| 11                         | 42375-3298         | 29   | 42375-3316  |
| 12                         | 42375-3299         | 30   | 42375-3317  |
| 13                         | 42375-3300         | 31   | 42375-3318  |
| 14                         | 42375-3301         | 32   | 42375-3319  |
| 15                         | 42375-3302         | 33   | 42375-3320  |
| 16                         | 42375-3303         | 34   | 42375-3321  |
| 17                         | 42375-3304         | 35   | 42375-3322  |
| 18                         | 42375-3305         | 36   | 42375-3323  |
| 19                         | 42375-3306         |      |             |

| ENG. NO: 42375-3324 / 3358 |                    |      |             |
|----------------------------|--------------------|------|-------------|
| HEADER NUMBER:             | 42312-0036         |      |             |
| PIN NUMBER:                | 42663-CCA154       |      |             |
| PIN LENGTH: L              | .670 / 17.02       |      |             |
| MATING LENGTH: M           | .440 / 11.18       |      |             |
| GOLD POINT: G              | NA                 |      |             |
| PC TAIL LENGTH: P          | .140 / 3.56        |      |             |
| TIN: T                     | OVERALL            |      |             |
| CKTS:                      | 2-36               |      |             |
| KINKS:                     | SMES-42003         |      |             |
| VOIDED CKTS:               | NONE               |      |             |
| PACKAGING:                 | BULK PK-40873-0041 |      |             |
| CKTS                       | ITEM NUMBER        | CKTS | ITEM NUMBER |
| 2                          | 42375-3324         | 20   | 42375-3342  |
| 3                          | 42375-3325         | 21   | 42375-3343  |
| 4                          | 42375-3326         | 22   | 42375-3344  |
| 5                          | 42375-3327         | 23   | 42375-3345  |
| 6                          | 42375-3328         | 24   | 42375-3346  |
| 7                          | 42375-3329         | 25   | 42375-3347  |
| 8                          | 42375-3330         | 26   | 42375-3348  |
| 9                          | 42375-3331         | 27   | 42375-3349  |
| 10                         | 42375-3332         | 28   | 42375-3350  |
| 11                         | 42375-3333         | 29   | 42375-3351  |
| 12                         | 42375-3334         | 30   | 42375-3352  |
| 13                         | 42375-3335         | 31   | 42375-3353  |
| 14                         | 42375-3336         | 32   | 42375-3354  |
| 15                         | 42375-3337         | 33   | 42375-3355  |
| 16                         | 42375-3338         | 34   | 42375-3356  |
| 17                         | 42375-3339         | 35   | 42375-3357  |
| 18                         | 42375-3340         | 36   | 42375-3358  |
| 19                         | 42375-3341         |      |             |

|  |   |  |  |  |                        |  |  |  |   |  |   |  |   |  |
|--|---|--|--|--|------------------------|--|--|--|---|--|---|--|---|--|
| <b>SYMBOLS</b><br>▽ = 0<br>▽ = 0<br>▽ = 0<br>▽ = 0<br>▽ = 0<br>▽ = 0<br>▽ = 0<br>▽ = 0<br>▽ = 0<br>▽ = 0 | THIS DRAWING CONTAINS INFORMATION THAT IS PROPRIETARY TO MOLEX ELECTRONIC TECHNOLOGIES, LLC AND SHOULD NOT BE USED WITHOUT WRITTEN PERMISSION |  | DIMENSION UNITS<br><b>MM/IN</b>                      |  | SCALE<br><b>1:1</b>    |  | CURRENT REV DESC: GOLD LENGTH SPEC CHANGED AS MIN 2.54- MAX 5.54 FOR A-42375-0037/0071 |  |  |  |   |  |   |  |
|  | GENERAL TOLERANCES (UNLESS SPECIFIED)   |  |  |  |                        |  | EC NO: 689596  |  |   |  |   |  | KK 100 HEADER ASSY<br>FLAT VERTICAL BREAKAWAY |  |
|  | 4 PLACES ±  |  | 3 PLACES ±   |  | 2 PLACES ±             |  | 1 PLACE ±  |  | 0 PLACES ±  |  | DRWN: SHRUTJ 2021/09/14<br>CHK'D: SHRUTJ 2021/12/20<br>APPR: ISHWARG 2021/12/20 |  |   |  |
|  | ANGULAR TOL ± 0.5°  |  | DRAFT WHERE APPLICABLE MUST REMAIN WITHIN DIMENSIONS |  | THIRD ANGLE PROJECTION |  | DRAWING  |  | SERIES  |  | DOCUMENT NUMBER<br><b>SD-42375-001</b>  |  | DOC TYPE DOC PART REVISION<br>PSD 001 V       |  |
|  |   |  |  |  | B-SIZE                 |  | 42375  |  | MATERIAL NUMBER<br>SEE CHART  |  | CUSTOMER<br>GENERAL MARKET  |  | SHEET NUMBER<br>22 OF 35                      |  |

| ENG. NO: 42375-3359 / 3393 |             |                    |             |
|----------------------------|-------------|--------------------|-------------|
| HEADER NUMBER:             |             | 42312-0036         |             |
| PIN NUMBER:                |             | 42663-ABB228       |             |
| PIN LENGTH: L              |             | .455 / 11.56       |             |
| MATING LENGTH: M           |             | .170 / 4.32        |             |
| GOLD POINT: G              |             | .100 / 2.54        |             |
| PC TAIL LENGTH: P          |             | .195 / 4.95        |             |
| TIN: T                     |             | .100 / 2.54        |             |
| CKTS:                      |             | 2-36               |             |
| KINKS:                     |             | NO                 |             |
| VOIDED CKTS:               |             | NONE               |             |
| PACKAGING:                 |             | BULK PK-40873-0041 |             |
| CKTS                       | ITEM NUMBER | CKTS               | ITEM NUMBER |
| 2                          | 42375-3359  | 20                 | 42375-3377  |
| 3                          | 42375-3360  | 21                 | 42375-3378  |
| 4                          | 42375-3361  | 22                 | 42375-3379  |
| 5                          | 42375-3362  | 23                 | 42375-3380  |
| 6                          | 42375-3363  | 24                 | 42375-3381  |
| 7                          | 42375-3364  | 25                 | 42375-3382  |
| 8                          | 42375-3365  | 26                 | 42375-3383  |
| 9                          | 42375-3366  | 27                 | 42375-3384  |
| 10                         | 42375-3367  | 28                 | 42375-3385  |
| 11                         | 42375-3368  | 29                 | 42375-3386  |
| 12                         | 42375-3369  | 30                 | 42375-3387  |
| 13                         | 42375-3370  | 31                 | 42375-3388  |
| 14                         | 42375-3371  | 32                 | 42375-3389  |
| 15                         | 42375-3372  | 33                 | 42375-3390  |
| 16                         | 42375-3373  | 34                 | 42375-3391  |
| 17                         | 42375-3374  | 35                 | 42375-3392  |
| 18                         | 42375-3375  | 36                 | 42375-3393  |
| 19                         | 42375-3376  |                    |             |

| ENG. NO: 42375-3394 / 3428 |             |                    |             |
|----------------------------|-------------|--------------------|-------------|
| HEADER NUMBER:             |             | 42312-0036         |             |
| PIN NUMBER:                |             | 42663-EZB208       |             |
| PIN LENGTH: L              |             | .970/24.64         |             |
| MATING LENGTH: M           |             | .780/19.81         |             |
| GOLD POINT: G              |             | .200/5.08          |             |
| PC TAIL LENGTH: P          |             | .100/ 2.54         |             |
| TIN: T                     |             | .200/5.08          |             |
| CKTS:                      |             | 2-36               |             |
| KINKS:                     |             | NO                 |             |
| VOIDED CKTS:               |             | NONE               |             |
| PACKAGING:                 |             | BULK PK-40873-0043 |             |
| CKTS                       | ITEM NUMBER | CKTS               | ITEM NUMBER |
| 2                          | 42375-3394  | 20                 | 42375-3412  |
| 3                          | 42375-3395  | 21                 | 42375-3413  |
| 4                          | 42375-3396  | 22                 | 42375-3414  |
| 5                          | 42375-3397  | 23                 | 42375-3415  |
| 6                          | 42375-3398  | 24                 | 42375-3416  |
| 7                          | 42375-3399  | 25                 | 42375-3417  |
| 8                          | 42375-3400  | 26                 | 42375-3418  |
| 9                          | 42375-3401  | 27                 | 42375-3419  |
| 10                         | 42375-3402  | 28                 | 42375-3420  |
| 11                         | 42375-3403  | 29                 | 42375-3421  |
| 12                         | 42375-3404  | 30                 | 42375-3422  |
| 13                         | 42375-3405  | 31                 | 42375-3423  |
| 14                         | 42375-3406  | 32                 | 42375-3424  |
| 15                         | 42375-3407  | 33                 | 42375-3425  |
| 16                         | 42375-3408  | 34                 | 42375-3426  |
| 17                         | 42375-3409  | 35                 | 42375-3427  |
| 18                         | 42375-3410  | 36                 | 42375-3428  |
| 19                         | 42375-3411  |                    |             |

| ENG. NO: 42375-3429 / 3463 |             |                    |             |
|----------------------------|-------------|--------------------|-------------|
| HEADER NUMBER:             |             | 42312-0036         |             |
| PIN NUMBER:                |             | 42663-ARA154       |             |
| PIN LENGTH: L              |             | .520/13.21         |             |
| MATING LENGTH: M           |             | .386/9.80          |             |
| GOLD POINT: G              |             | N/A                |             |
| PC TAIL LENGTH: P          |             | .044/1.12          |             |
| TIN: T                     |             | OVERALL            |             |
| CKTS:                      |             | 2-36               |             |
| KINKS:                     |             | NO                 |             |
| VOIDED CKTS:               |             | NONE               |             |
| PACKAGING:                 |             | BULK PK-40873-0041 |             |
| CKTS                       | ITEM NUMBER | CKTS               | ITEM NUMBER |
| 2                          | 42375-3429  | 20                 | 42375-3447  |
| 3                          | 42375-3430  | 21                 | 42375-3448  |
| 4                          | 42375-3431  | 22                 | 42375-3449  |
| 5                          | 42375-3432  | 23                 | 42375-3450  |
| 6                          | 42375-3433  | 24                 | 42375-3451  |
| 7                          | 42375-3434  | 25                 | 42375-3452  |
| 8                          | 42375-3435  | 26                 | 42375-3453  |
| 9                          | 42375-3436  | 27                 | 42375-3454  |
| 10                         | 42375-3437  | 28                 | 42375-3455  |
| 11                         | 42375-3438  | 29                 | 42375-3456  |
| 12                         | 42375-3439  | 30                 | 42375-3457  |
| 13                         | 42375-3440  | 31                 | 42375-3458  |
| 14                         | 42375-3441  | 32                 | 42375-3459  |
| 15                         | 42375-3442  | 33                 | 42375-3460  |
| 16                         | 42375-3443  | 34                 | 42375-3461  |
| 17                         | 42375-3444  | 35                 | 42375-3462  |
| 18                         | 42375-3445  | 36                 | 42375-3463  |
| 19                         | 42375-3446  |                    |             |

|                 |    |              |            |          |
|-----------------|----|--------------|------------|----------|
| DOCUMENT STATUS | P1 | RELEASE DATE | 2021/12/20 | 12:18:33 |
|-----------------|----|--------------|------------|----------|

|  |   |  |  |  |  |  |  |  |  |  |
|--|---|--|--|--|--|--|--|--|--|--|
| <b>SYMBOLS</b><br> = 0<br> = 0<br> = 0<br> = 0<br> = 0<br> = 0<br> = 0<br> = 0 | THIS DRAWING CONTAINS INFORMATION THAT IS PROPRIETARY TO MOLEX ELECTRONIC TECHNOLOGIES, LLC AND SHOULD NOT BE USED WITHOUT WRITTEN PERMISSION |  | DIMENSION UNITS: <b>MM/IN</b><br>SCALE: <b>1:1</b>   |  | CURRENT REV DESC: GOLD LENGTH SPEC CHANGED AS MIN 2.54- MAX 5.54 FOR A-42375-0037/0071 |  | <br>KK 100 HEADER ASSY<br>FLAT VERTICAL BREAKAWAY |  |  |  |
|  | GENERAL TOLERANCES (UNLESS SPECIFIED)   |  | EC NO: 689596<br>DRWN: SHRUTJ 2021/09/14<br>CHK'D: SHRUTJ 2021/12/20<br>APPR: ISHWARG 2021/12/20 |  | PRODUCT CUSTOMER DRAWING   |  |  |  |  |  |
|  | 4 PLACES ± 0.25 ±<br>3 PLACES ± 0.25 ±<br>2 PLACES ± 0.25 ±<br>1 PLACE ± 0.38 ±<br>0 PLACES ± 0.38 ±  |  | INITIAL REVISION:<br>DRWN: SCHAFFER 2003/02/11<br>APPR: MARGULIS 2004/02/27                      |  | DOCUMENT NUMBER: <b>SD-42375-001</b><br>DOC TYPE: PSD<br>DOC PART: 001<br>REVISION: V  |  |  |  |  |  |
|  | ANGULAR TOL ± 0.5°  |  | DRAFT WHERE APPLICABLE MUST REMAIN WITHIN DIMENSIONS   |  | THIRD ANGLE PROJECTION   |  | DRAWING: B-SIZE<br>SERIES: 42375   |  | MATERIAL NUMBER: SEE CHART<br>CUSTOMER: GENERAL MARKET<br>SHEET NUMBER: 23 OF 35 |  |

| ENG. NO: 42375-3464 / 3498 |              |                    |              |
|----------------------------|--------------|--------------------|--------------|
| HEADER NUMBER:             |              | 42312-0036         |              |
| PIN NUMBER:                |              | 42663-CJA154       |              |
| PIN LENGTH: L              |              | .700/17.78         |              |
| MATING LENGTH: M           |              | .500/12.70         |              |
| GOLD POINT: G              |              | N/A                |              |
| PC TAIL LENGTH: P          |              | 110/2.79           |              |
| TIN: T                     |              | OVERALL            |              |
| CKTS:                      |              | 2-36               |              |
| KINKS:                     |              | NO                 |              |
| VOIDED CKTS:               |              | #2                 |              |
| PACKAGING:                 |              | BULK PK-40873-0041 |              |
| CKTS                       | ITEM NUMBER  | CKTS               | ITEM NUMBER  |
| 2                          | 42375-3464   | 20                 | 42375-3482   |
| 3                          | 42375-3465   | 21                 | 42375-3483   |
| 4                          | 42375-3466   | 22                 | 42375-3484   |
| 5                          | 42375-3467   | 23                 | 42375-3480 5 |
| 6                          | 42375-3468   | 24                 | 42375-3486   |
| 7                          | 42375-3469   | 25                 | 42375-3487   |
| 8                          | 42375-3470   | 26                 | 42375-3488   |
| 9                          | 42375-3471   | 27                 | 42375-3489   |
| 10                         | 42375-3472   | 28                 | 42375-34890  |
| 11                         | 42375-3473   | 29                 | 42375-3491   |
| 12                         | 42375-3474   | 30                 | 42375-3492   |
| 13                         | 42375-3475   | 31                 | 42375-3493   |
| 14                         | 42375-3476   | 32                 | 42375-3494   |
| 15                         | 42375-3470 7 | 33                 | 42375-3495   |
| 16                         | 42375-3478   | 34                 | 42375-3496   |
| 17                         | 42375-3479   | 35                 | 42375-3497   |
| 18                         | 42375-3480   | 36                 | 42375-3498   |
| 19                         | 42375-3481   |                    |              |

| ENG. NO: 42375-3499/3533 |             |                    |             |
|--------------------------|-------------|--------------------|-------------|
| HEADER NUMBER:           |             | 42312-0036         |             |
| PIN NUMBER:              |             | 42663-ETA154       |             |
| PIN LENGTH: L            |             | .950/24.13         |             |
| MATING LENGTH: M         |             | .750/19.05         |             |
| GOLD POINT: G            |             | N/A                |             |
| PC TAIL LENGTH: P        |             | 110/2.79           |             |
| TIN: T                   |             | OVERALL            |             |
| CKTS:                    |             | 2-36               |             |
| KINKS:                   |             | NO                 |             |
| VOIDED CKTS:             |             | NONE               |             |
| PACKAGING:               |             | BULK PK-40873-0043 |             |
| CKTS                     | ITEM NUMBER | CKTS               | ITEM NUMBER |
| 2                        | 42375-3499  | 20                 | 42375-3517  |
| 3                        | 42375-3500  | 21                 | 42375-3518  |
| 4                        | 42375-3501  | 22                 | 42375-3519  |
| 5                        | 42375-3502  | 23                 | 42375-3520  |
| 6                        | 42375-3503  | 24                 | 42375-3521  |
| 7                        | 42375-3504  | 25                 | 42375-3522  |
| 8                        | 42375-3505  | 26                 | 42375-3523  |
| 9                        | 42375-3506  | 27                 | 42375-3524  |
| 10                       | 42375-3507  | 28                 | 42375-3525  |
| 11                       | 42375-3508  | 29                 | 42375-3526  |
| 12                       | 42375-3509  | 30                 | 42375-3527  |
| 13                       | 42375-3510  | 31                 | 42375-3528  |
| 14                       | 42375-3511  | 32                 | 42375-3529  |
| 15                       | 42375-3512  | 33                 | 42375-3530  |
| 16                       | 42375-3513  | 34                 | 42375-3531  |
| 17                       | 42375-3514  | 35                 | 42375-3532  |
| 18                       | 42375-3515  | 36                 | 42375-3533  |
| 19                       | 42375-3516  |                    |             |









| ENG. NO: 42375-3534/3568 |             |                    |             |
|--------------------------|-------------|--------------------|-------------|
| HEADER NUMBER:           |             | 42312-0036         |             |
| PIN NUMBER:              |             | 42663-AWB208       |             |
| PIN LENGTH: L            |             | .535/13.59         |             |
| MATING LENGTH: M         |             | .235/5.97          |             |
| GOLD POINT: G            |             | .200/5.08          |             |
| PC TAIL LENGTH: P        |             | .210/5.33          |             |
| TIN: T                   |             | .100/2.54          |             |
| CKTS:                    |             | 2-36               |             |
| KINKS:                   |             | NO                 |             |
| VOIDED CKTS:             |             | NONE               |             |
| PACKAGING:               |             | BULK PK-40873-0041 |             |
| CKTS                     | ITEM NUMBER | CKTS               | ITEM NUMBER |
| 2                        | 42375-3534  | 20                 | 42375-3572  |
| 3                        | 42375-3535  | 21                 | 42375-3573  |
| 4                        | 42375-3536  | 22                 | 42375-3574  |
| 5                        | 42375-3537  | 23                 | 42375-3575  |
| 6                        | 42375-3538  | 24                 | 42375-3576  |
| 7                        | 42375-3539  | 25                 | 42375-3577  |
| 8                        | 42375-3560  | 26                 | 42375-3578  |
| 9                        | 42375-3561  | 27                 | 42375-3579  |
| 10                       | 42375-3562  | 28                 | 42375-3580  |
| 11                       | 42375-3563  | 29                 | 42375-3581  |
| 12                       | 42375-3564  | 30                 | 42375-3582  |
| 13                       | 42375-3565  | 31                 | 42375-3583  |
| 14                       | 42375-3566  | 32                 | 42375-3584  |
| 15                       | 42375-3567  | 33                 | 42375-3585  |
| 16                       | 42375-3568  | 34                 | 42375-3586  |
| 17                       | 42375-3569  | 35                 | 42375-3587  |
| 18                       | 42375-3570  | 36                 | 42375-3588  |
| 19                       | 42375-3571  |                    |             |

|   |   |  |   |   |  |
|---|---|--|---|---|--|
| <b>SYMBOLS</b><br>= 0<br>= 0<br>= 0<br>= 0<br>= 0<br>= 0<br>= 0<br>= 0<br>= 0 | THIS DRAWING CONTAINS INFORMATION THAT IS PROPRIETARY TO MOLEX ELECTRONIC TECHNOLOGIES, LLC AND SHOULD NOT BE USED WITHOUT WRITTEN PERMISSION<br>DIMENSION UNITS: <b>MM/IN</b><br>SCALE: <b>1:1</b> | CURRENT REV DESC: GOLD LENGTH SPEC<br>CHANGED AS MIN 2.54- MAX 5.54 FOR<br>A-42375-0037/0071<br>EC NO: 689596<br>DRWN: SHRUTJ 2021/09/14<br>CHK'D: SHRUTJ 2021/12/20<br>APPR: ISHWARG 2021/12/20 | <br>KK 100 HEADER ASSY<br>FLAT VERTICAL BREAKAWAY<br>PRODUCT CUSTOMER DRAWING |   |  |
|   | GENERAL TOLERANCES<br>(UNLESS SPECIFIED)  | INITIAL REVISION:<br>DRWN: SCHAFFER 2003/02/11<br>APPR: MARGULIS 2004/02/27  |   | DOCUMENT NUMBER: <b>SD-42375-001</b><br>DOC TYPE: PSD<br>DOC PART: 001<br>REVISION: V |  |
|   | 4 PLACES ±<br>3 PLACES ± 0.01<br>2 PLACES ± 0.25<br>1 PLACE ± 0.38<br>0 PLACES ±  | ANGULAR TOL ± 0.5°<br>DRAFT WHERE APPLICABLE<br>MUST REMAIN<br>WITHIN DIMENSIONS   |   | THIRD ANGLE PROJECTION<br><br>DRAWING: B-SIZE<br>SERIES: 42375                        | MATERIAL NUMBER: SEE CHART<br>CUSTOMER: GENERAL MARKET<br>SHEET NUMBER: 24 OF 35 |
|   |   |  |   |   |  |



| ENG. NO: A-42375-3569/3603 |                 |                    |      |                 |            |
|----------------------------|-----------------|--------------------|------|-----------------|------------|
| HEADER NUMBER:             |                 | 42312-0036         |      |                 |            |
| PIN NUMBER:                |                 | 42663-ABB208       |      |                 |            |
| PIN LENGTH: L              |                 | .530 / 13.46       |      |                 |            |
| MATING LENGTH: M           |                 | .240 / 6.09        |      |                 |            |
| GOLD POINT: G              |                 | .100 / 2.54        |      |                 |            |
| PC TAIL LENGTH: P          |                 | .125 / 3.18        |      |                 |            |
| TIN: T                     |                 | .100 / 2.54        |      |                 |            |
| CKTS:                      |                 | 4-36               |      |                 |            |
| KINKS:                     |                 | NO                 |      |                 |            |
| VOIDED CKTS:               |                 | 5                  |      |                 |            |
| PACKAGING:                 |                 | BULK PK-40873-0041 |      |                 |            |
| CKTS                       | MATERIAL NUMBER | ENG NUMBER         | CKTS | MATERIAL NUMBER | ENG NUMBER |
| 2                          |                 |                    | 20   | 423753587       | 42375-3587 |
| 3                          |                 |                    | 21   | 423753588       | 42375-3588 |
| 4                          |                 |                    | 22   | 423753589       | 42375-3589 |
| 5                          | 423753572       | 42375-3572         | 23   | 423753590       | 42375-3590 |
| 6                          | 423753573       | 42375-3573         | 24   | 423753591       | 42375-3591 |
| 7                          | 423753574       | 42375-3574         | 25   | 423753592       | 42375-3592 |
| 8                          | 423753575       | 42375-3575         | 26   | 423753593       | 42375-3593 |
| 9                          | 423753576       | 42375-3576         | 27   | 423753594       | 42375-3594 |
| 10                         | 423753577       | 42375-3577         | 28   | 423753595       | 42375-3595 |
| 11                         | 423753578       | 42375-3578         | 29   | 423753596       | 42375-3596 |
| 12                         | 423753579       | 42375-3579         | 30   | 423753597       | 42375-3597 |
| 13                         | 423753580       | 42375-3580         | 31   | 423753598       | 42375-3598 |
| 14                         | 423753581       | 42375-3581         | 32   | 423753599       | 42375-3599 |
| 15                         | 423753582       | 42375-3582         | 33   | 423753600       | 42375-3600 |
| 16                         | 423753583       | 42375-3583         | 34   | 423753601       | 42375-3601 |
| 17                         | 423753584       | 42375-3584         | 35   | 423753602       | 42375-3602 |
| 18                         | 423753585       | 42375-3585         | 36   | 423753603       | 42375-3603 |
| 19                         | 423753586       | 42375-3586         |      |                 |            |

| ENG. NO: A-42375-2974/3008 |                 |                    |      |                 |             |
|----------------------------|-----------------|--------------------|------|-----------------|-------------|
| HEADER NUMBER:             |                 | 42312-0036         |      |                 |             |
| PIN NUMBER:                |                 | 42663-FKB228       |      |                 |             |
| PIN LENGTH: L              |                 | 1.020 / 25.91      |      |                 |             |
| MATING LENGTH: M           |                 | .805 / 20.45       |      |                 |             |
| GOLD POINT: G              |                 | .200 / 5.08        |      |                 |             |
| PC TAIL LENGTH: P          |                 | .125 / 3.18        |      |                 |             |
| TIN: T                     |                 | .200 / 5.08        |      |                 |             |
| CKTS:                      |                 | 2-36               |      |                 |             |
| KINKS:                     |                 | NO                 |      |                 |             |
| VOIDED CKTS:               |                 | NONE               |      |                 |             |
| PACKAGING:                 |                 | BULK PK-40873-0043 |      |                 |             |
| CKTS                       | MATERIAL NUMBER | ENG NUMBER         | CKTS | MATERIAL NUMBER | ITEM NUMBER |
| 2                          |                 |                    | 20   |                 |             |
| 3                          |                 |                    | 21   |                 |             |
| 4                          |                 |                    | 22   |                 |             |
| 5                          | 423752977       | 42375-2977         | 23   |                 |             |
| 6                          |                 |                    | 24   |                 |             |
| 7                          |                 |                    | 25   |                 |             |
| 8                          |                 |                    | 26   |                 |             |
| 9                          |                 |                    | 27   |                 |             |
| 10                         |                 |                    | 28   |                 |             |
| 11                         |                 |                    | 29   |                 |             |
| 12                         |                 |                    | 30   |                 |             |
| 13                         |                 |                    | 31   |                 |             |
| 14                         |                 |                    | 32   |                 |             |
| 15                         |                 |                    | 33   |                 |             |
| 16                         |                 |                    | 34   |                 |             |
| 17                         |                 |                    | 35   |                 |             |
| 18                         |                 |                    | 36   |                 |             |
| 19                         |                 |                    |      |                 |             |

|  |  |   |   |  |  |
|--|--|---|---|--|--|
| <b>SYMBOLS</b><br> = 0<br> = 0<br> = 0<br> = 0<br> = 0<br> = 0<br> = 0<br> = 0 | THIS DRAWING CONTAINS INFORMATION THAT IS PROPRIETARY TO MOLEX ELECTRONIC TECHNOLOGIES, LLC AND SHOULD NOT BE USED WITHOUT WRITTEN PERMISSION<br>DIMENSION UNITS: <b>MM/IN</b> SCALE: <b>1:1</b> |   | CURRENT REV DESC: GOLD LENGTH SPEC<br>CHANGED AS MIN 2.54- MAX 5.54 FOR<br>A-42375-0037/0071                    | <br><br>KK 100 HEADER ASSY<br>FLAT VERTICAL BREAKAWAY<br><br>PRODUCT CUSTOMER DRAWING |  |
|  | GENERAL TOLERANCES<br>(UNLESS SPECIFIED)   |   | EC NO: 689596<br>DRWN: SHRUTJ      2021/09/14<br>CHK'D: SHRUTJ      2021/12/20<br>APPR: ISHWARG      2021/12/20 |  |  |
|  | 4 PLACES ±   | MM  | INCH  |  | INITIAL REVISION:<br>DRWN: SCHAFFER      2003/02/11<br>APPR: MARGULIS      2004/02/27  |
|  | 3 PLACES ±   | MM  | INCH  |  | DOCUMENT NUMBER: <b>SD-42375-001</b> DOC TYPE: PSD      DOC PART: 001      REVISION: V |
|  | 2 PLACES ±   | MM  | INCH  |  | MATERIAL NUMBER: SEE CHART      CUSTOMER: GENERAL MARKET      SHEET NUMBER: 25 OF 35   |
|  | 1 PLACE ±  | MM  | INCH  |  |  |
|  | 0 PLACES ±   | MM  | INCH  |  |  |
|  | ANGULAR TOL ± 0.5°   | DRAFT WHERE APPLICABLE<br>MUST REMAIN WITHIN DIMENSIONS |   |  | THIRD ANGLE PROJECTION      DRAWING: B-SIZE      SERIES: 42375                         |
|  |  |   |   |  |  |
|  |  |   |   |  |  |

| ENG. NO: A-42375-3604/3637 |                 |                    |      |                 |            |
|----------------------------|-----------------|--------------------|------|-----------------|------------|
| HEADER NUMBER:             |                 | 42312-0036         |      |                 |            |
| PIN NUMBER:                |                 | 42663-AXA154       |      |                 |            |
| PIN LENGTH: L              |                 | .540 / 13.72       |      |                 |            |
| MATING LENGTH: M           |                 | .380 / 9.65        |      |                 |            |
| GOLD POINT: G              |                 | N/A                |      |                 |            |
| PC TAIL LENGTH: P          |                 | .070 / 1.78        |      |                 |            |
| TIN: T                     |                 | OVERALL            |      |                 |            |
| CKTS:                      |                 | 2-36               |      |                 |            |
| KINKS:                     |                 | NO                 |      |                 |            |
| VOIDED CKTS:               |                 | 2                  |      |                 |            |
| PACKAGING:                 |                 | BULK PK-40873-0041 |      |                 |            |
| CKTS                       | MATERIAL NUMBER | ENG NUMBER         | CKTS | MATERIAL NUMBER | ENG NUMBER |
| 2                          |                 |                    | 20   |                 |            |
| 3                          | 42375-3604      |                    | 21   |                 |            |
| 4                          |                 |                    | 22   |                 |            |
| 5                          |                 |                    | 23   |                 |            |
| 6                          |                 |                    | 24   |                 |            |
| 7                          |                 |                    | 25   |                 |            |
| 8                          |                 |                    | 26   |                 |            |
| 9                          |                 |                    | 27   |                 |            |
| 10                         |                 |                    | 28   |                 |            |
| 11                         |                 |                    | 29   |                 |            |
| 12                         |                 |                    | 30   |                 |            |
| 13                         |                 |                    | 31   |                 |            |
| 14                         |                 |                    | 32   |                 |            |
| 15                         |                 |                    | 33   |                 |            |
| 16                         |                 |                    | 34   |                 |            |
| 17                         |                 |                    | 35   |                 |            |
| 18                         |                 |                    | 36   |                 |            |
| 19                         |                 |                    |      |                 |            |

| ENG. NO: A-42375-3638/3658 |                 |                            |      |                 |             |
|----------------------------|-----------------|----------------------------|------|-----------------|-------------|
| HEADER NUMBER:             |                 | 42312-0036                 |      |                 |             |
| PIN NUMBER:                |                 | 42663-ABA154               |      |                 |             |
| PIN LENGTH: L              |                 | .455 / 11.56               |      |                 |             |
| MATING LENGTH: M           |                 | .240 / 6.09                |      |                 |             |
| GOLD POINT: G              |                 | N/A                        |      |                 |             |
| PC TAIL LENGTH: P          |                 | .125 / 3.18                |      |                 |             |
| TIN: T                     |                 | OVERALL                    |      |                 |             |
| CKTS:                      |                 | 2-36                       |      |                 |             |
| KINKS:                     |                 | NO                         |      |                 |             |
| VOIDED CKTS:               |                 | 2, 4, 6, 8, 10, 12, 14, 16 |      |                 |             |
| PACKAGING:                 |                 | BULK PK-40873-0041         |      |                 |             |
| CKTS                       | MATERIAL NUMBER | ENG NUMBER                 | CKTS | MATERIAL NUMBER | ITEM NUMBER |
| 2                          |                 |                            | 20   |                 |             |
| 3                          |                 |                            | 21   |                 |             |
| 4                          |                 |                            | 22   |                 |             |
| 5                          |                 |                            | 23   |                 |             |
| 6                          |                 |                            | 24   |                 |             |
| 7                          |                 |                            | 25   |                 |             |
| 8                          |                 |                            | 26   |                 |             |
| 9                          |                 |                            | 27   |                 |             |
| 10                         |                 |                            | 28   |                 |             |
| 11                         |                 |                            | 29   |                 |             |
| 12                         |                 |                            | 30   |                 |             |
| 13                         |                 |                            | 31   |                 |             |
| 14                         |                 |                            | 32   |                 |             |
| 15                         |                 |                            | 33   |                 |             |
| 16                         |                 |                            | 34   |                 |             |
| 17                         | 423753639       | 42375-3639                 | 35   |                 |             |
| 18                         |                 |                            | 36   |                 |             |
| 19                         |                 |                            |      |                 |             |

| <b>SYMBOLS</b><br>= 0<br>= 0<br>= 0<br>= 0<br>= 0<br>= 0<br>= 0<br>= 0<br>= 0 | THIS DRAWING CONTAINS INFORMATION THAT IS PROPRIETARY TO MOLEX ELECTRONIC TECHNOLOGIES, LLC AND SHOULD NOT BE USED WITHOUT WRITTEN PERMISSION<br>DIMENSION UNITS: <b>MM/IN</b><br>SCALE: <b>1:1</b>   | CURRENT REV DESC: GOLD LENGTH SPEC CHANGED AS MIN 2.54- MAX 5.54 FOR A-42375-0037/0071<br>EC NO: 689596<br>DRWN: SHRUTJ 2021/09/14<br>CHK'D: SHRUTJ 2021/12/20<br>APPR: ISHWARG 2021/12/20 | <br>KK 100 HEADER ASSY<br>FLAT VERTICAL BREAKAWAY<br>PRODUCT CUSTOMER DRAWING    |      |      |            |  |  |            |  |        |            |      |  |           |      |  |            |  |  |   |   |
|---|---|--|--|------|------|------------|--|--|------------|--|--------|------------|------|--|-----------|------|--|------------|--|--|---|---|
|   | GENERAL TOLERANCES (UNLESS SPECIFIED)<br><table border="1"> <tr><th></th><th>MM</th><th>INCH</th></tr> <tr><td>4 PLACES ±</td><td></td><td></td></tr> <tr><td>3 PLACES ±</td><td></td><td>± 0.01</td></tr> <tr><td>2 PLACES ±</td><td>0.25</td><td></td></tr> <tr><td>1 PLACE ±</td><td>0.38</td><td></td></tr> <tr><td>0 PLACES ±</td><td></td><td></td></tr> </table> |  |  | MM   | INCH | 4 PLACES ± |  |  | 3 PLACES ± |  | ± 0.01 | 2 PLACES ± | 0.25 |  | 1 PLACE ± | 0.38 |  | 0 PLACES ± |  |  | INITIAL REVISION:<br>DRWN: SCHAFFER 2003/02/11<br>APPR: MARGULIS 2004/02/27 | DOCUMENT NUMBER: <b>SD-42375-001</b><br>DOC TYPE: PSD<br>DOC PART: 001<br>REVISION: V |
|   |   | MM   |  | INCH |      |            |  |  |            |  |        |            |      |  |           |      |  |            |  |  |   |   |
|   | 4 PLACES ±  |  |  |      |      |            |  |  |            |  |        |            |      |  |           |      |  |            |  |  |   |   |
| 3 PLACES ±  |   | ± 0.01   |  |      |      |            |  |  |            |  |        |            |      |  |           |      |  |            |  |  |   |   |
| 2 PLACES ±  | 0.25  |  |  |      |      |            |  |  |            |  |        |            |      |  |           |      |  |            |  |  |   |   |
| 1 PLACE ±   | 0.38  |  |  |      |      |            |  |  |            |  |        |            |      |  |           |      |  |            |  |  |   |   |
| 0 PLACES ±  |   |  |  |      |      |            |  |  |            |  |        |            |      |  |           |      |  |            |  |  |   |   |
| ANGULAR TOL ± 0.5°<br>DRAFT WHERE APPLICABLE MUST REMAIN WITHIN DIMENSIONS    | THIRD ANGLE PROJECTION<br>  | DRAWING: B-SIZE<br>SERIES: 42375   | MATERIAL NUMBER: SEE CHART<br>CUSTOMER: GENERAL MARKET<br>SHEET NUMBER: 26 OF 35 |      |      |            |  |  |            |  |        |            |      |  |           |      |  |            |  |  |   |   |
| DOCUMENT STATUS: P1<br>RELEASE DATE: 2021/12/20 12:18:33                      |   |  |  |      |      |            |  |  |            |  |        |            |      |  |           |      |  |            |  |  |   |   |

| ENG. NO: 42375-3659/3693 |                 |                    |      |                 |            |
|--------------------------|-----------------|--------------------|------|-----------------|------------|
| HEADER NUMBER:           |                 | 42312-0036         |      |                 |            |
| PIN NUMBER:              |                 | 42663-AXB208       |      |                 |            |
| PIN LENGTH: L            |                 | .540 / 13.72       |      |                 |            |
| MATING LENGTH: M         |                 | .250 / 6.35        |      |                 |            |
| GOLD POINT: G            |                 | .140 / 3.56        |      |                 |            |
| PC TAIL LENGTH: P        |                 | .200 / 5.08        |      |                 |            |
| TIN: T                   |                 | .135 / 3.43        |      |                 |            |
| CKTS:                    |                 | 2-36               |      |                 |            |
| KINKS:                   |                 | NO                 |      |                 |            |
| VOIDED CKTS:             |                 | NONE               |      |                 |            |
| PACKAGING:               |                 | BULK PK-40873-0041 |      |                 |            |
| CKTS                     | MATERIAL NUMBER | ENG NUMBER         | CKTS | MATERIAL NUMBER | ENG NUMBER |
| 2                        | 68300-2000      | 42375-3659         | 20   |                 | 42375-3677 |
| 3                        | 68300-2001      | 42375-3660         | 21   |                 | 42375-3678 |
| 4                        |                 | 42375-3661         | 22   |                 | 42375-3679 |
| 5                        | 68300-2006      | 42375-3662         | 23   |                 | 42375-3680 |
| 6                        |                 | 42375-3663         | 24   |                 | 42375-3681 |
| 7                        |                 | 42375-3664         | 25   |                 | 42375-3682 |
| 8                        |                 | 42375-3665         | 26   |                 | 42375-3683 |
| 9                        |                 | 42375-3666         | 27   |                 | 42375-3684 |
| 10                       |                 | 42375-3667         | 28   |                 | 42375-3685 |
| 11                       |                 | 42375-3668         | 29   |                 | 42375-3686 |
| 12                       |                 | 42375-3669         | 30   |                 | 42375-3687 |
| 13                       |                 | 42375-3670         | 31   |                 | 42375-3688 |
| 14                       |                 | 42375-3671         | 32   |                 | 42375-3689 |
| 15                       |                 | 42375-3672         | 33   |                 | 42375-3690 |
| 16                       |                 | 42375-3673         | 34   |                 | 42375-3691 |
| 17                       |                 | 42375-3674         | 35   |                 | 42375-3692 |
| 18                       |                 | 42375-3675         | 36   |                 | 42375-3693 |
| 19                       |                 | 42375-3676         |      |                 |            |

| ENG. NO: 42375-3694/3728 |                 |                    |      |                 |            |
|--------------------------|-----------------|--------------------|------|-----------------|------------|
| HEADER NUMBER:           |                 | 42312-0036         |      |                 |            |
| PIN NUMBER:              |                 | 42663-AXB208       |      |                 |            |
| PIN LENGTH: L            |                 | .540 / 13.72       |      |                 |            |
| MATING LENGTH: M         |                 | .250 / 6.35        |      |                 |            |
| GOLD POINT: G            |                 | .140 / 3.56        |      |                 |            |
| PC TAIL LENGTH: P        |                 | .200 / 5.08        |      |                 |            |
| TIN: T                   |                 | .135 / 3.43        |      |                 |            |
| CKTS:                    |                 | 2-36               |      |                 |            |
| KINKS:                   |                 | NO                 |      |                 |            |
| VOIDED CKTS:             |                 | 5                  |      |                 |            |
| PACKAGING:               |                 | BULK PK-40873-0041 |      |                 |            |
| CKTS                     | MATERIAL NUMBER | ENG NUMBER         | CKTS | MATERIAL NUMBER | ENG NUMBER |
| 2                        |                 | 42375-3694         | 20   |                 | 42375-3712 |
| 3                        |                 | 42375-3695         | 21   |                 | 42375-3713 |
| 4                        |                 | 42375-3696         | 22   |                 | 42375-3714 |
| 5                        |                 | 42375-3697         | 23   |                 | 42375-3715 |
| 6                        |                 | 42375-3698         | 24   |                 | 42375-3716 |
| 7                        |                 | 42375-3699         | 25   |                 | 42375-3717 |
| 8                        | 68300-2002      | 42375-3700         | 26   |                 | 42375-3718 |
| 9                        |                 | 42375-3701         | 27   |                 | 42375-3719 |
| 10                       |                 | 42375-3702         | 28   |                 | 42375-3720 |
| 11                       |                 | 42375-3703         | 29   |                 | 42375-3721 |
| 12                       |                 | 42375-3704         | 30   |                 | 42375-3722 |
| 13                       |                 | 42375-3705         | 31   |                 | 42375-3723 |
| 14                       |                 | 42375-3706         | 32   |                 | 42375-3724 |
| 15                       |                 | 42375-3707         | 33   |                 | 42375-3725 |
| 16                       |                 | 42375-3708         | 34   |                 | 42375-3726 |
| 17                       |                 | 42375-3709         | 35   |                 | 42375-3727 |
| 18                       |                 | 42375-3710         | 36   |                 | 42375-3728 |
| 19                       |                 | 42375-3711         |      |                 |            |

|         |   |              |  |                |                          |
|---------|---|--------------|--|----------------|--------------------------|
| SYMBOLS | THIS DRAWING CONTAINS INFORMATION THAT IS PROPRIETARY TO MOLEX ELECTRONIC TECHNOLOGIES, LLC AND SHOULD NOT BE USED WITHOUT WRITTEN PERMISSION |              |  |                |                          |
|         | DIMENSION UNITS   | SCALE        | CURRENT REV DESC: GOLD LENGTH SPEC CHANGED AS MIN 2.54- MAX 5.54 FOR A-42375-0037/0071   |                |                          |
| ▽ = 0   | MM/IN   | 1:1          | <br>KK 100 HEADER ASSY<br>FLAT VERTICAL BREAKAWAY |                |                          |
| ▽ = 0   | GENERAL TOLERANCES (UNLESS SPECIFIED)   |              |  |                |                          |
| ▽ = 0   |   |              | EC NO: 689596  |                |                          |
| ▽ = 0   | 4 PLACES ±  | ±            | DRWN: SHRUTJ   | 2021/09/14     | PRODUCT CUSTOMER DRAWING |
| ▽ = 0   | 3 PLACES ±  | ± 0.01       | CHK'D: SHRUTJ  | 2021/12/20     |                          |
| ▽ = 0   | 2 PLACES ±  | ± 0.25       | APPR: ISHWARG  | 2021/12/20     | DOCUMENT NUMBER          |
| ▽ = 0   | 1 PLACE ±   | ± 0.38       | INITIAL REVISION:  |                |                          |
| ▽ = 0   | 0 PLACES ±  | ±            | DRWN: SCHAFFER   | 2003/02/11     | SD-42375-001             |
| ▽ = 0   | ANGULAR TOL ±   | ± 0.5°       | APPR: MARGULIS   | 2004/02/27     |                          |
| □ = 0   | DRAFT WHERE APPLICABLE MUST REMAIN WITHIN DIMENSIONS  |              | THIRD ANGLE PROJECTION   | DRAWING        | DOC TYPE                 |
| ▽ = 0   |   |              |   | B-SIZE         | DOC PART                 |
|         |   |              | SERIES   | 42375          | REVISION                 |
|         | SEE CHART   | CUSTOMER     |  | GENERAL MARKET | V                        |
|         |   | SHEET NUMBER |  |                | 27 OF 35                 |

| ENG. NO: 42375-3659/3693 |                 |                    |      |                 |            |
|--------------------------|-----------------|--------------------|------|-----------------|------------|
| HEADER NUMBER:           |                 | 42312-0036         |      |                 |            |
| PIN NUMBER:              |                 | 42663-AXB208       |      |                 |            |
| PIN LENGTH: L            |                 | .540 / 13.72       |      |                 |            |
| MATING LENGTH: M         |                 | .250 / 6.35        |      |                 |            |
| GOLD POINT: G            |                 | .140 / 3.56        |      |                 |            |
| PC TAIL LENGTH: P        |                 | .200 / 5.08        |      |                 |            |
| TIN: T                   |                 | .135 / 3.43        |      |                 |            |
| CKTS:                    |                 | 2-36               |      |                 |            |
| KINKS:                   |                 | NO                 |      |                 |            |
| VOIDED CKTS:             |                 | 5                  |      |                 |            |
| PACKAGING:               |                 | BULK PK-40873-0041 |      |                 |            |
| CKTS                     | MATERIAL NUMBER | ENG NUMBER         | CKTS | MATERIAL NUMBER | ENG NUMBER |
| 2                        |                 | 42375-3729         | 20   |                 | 42375-3747 |
| 3                        |                 | 42375-3730         | 21   |                 | 42375-3748 |
| 4                        |                 | 42375-3731         | 22   |                 | 42375-3749 |
| 5                        |                 | 42375-3732         | 23   |                 | 42375-3750 |
| 6                        |                 | 42375-3733         | 24   |                 | 42375-3751 |
| 7                        |                 | 42375-3734         | 25   |                 | 42375-3752 |
| 8                        | 68300-2007      | 42375-3735         | 26   |                 | 42375-3753 |
| 9                        |                 | 42375-3736         | 27   |                 | 42375-3754 |
| 10                       |                 | 42375-3737         | 28   |                 | 42375-3755 |
| 11                       |                 | 42375-3738         | 29   |                 | 42375-3756 |
| 12                       |                 | 42375-3739         | 30   |                 | 42375-3757 |
| 13                       |                 | 42375-3740         | 31   |                 | 42375-3758 |
| 14                       |                 | 42375-3741         | 32   |                 | 42375-3759 |
| 15                       |                 | 42375-3742         | 33   |                 | 42375-3760 |
| 16                       |                 | 42375-3743         | 34   |                 | 42375-3761 |
| 17                       |                 | 42375-3744         | 35   |                 | 42375-3762 |
| 18                       |                 | 42375-3745         | 36   |                 | 42375-3763 |
| 19                       |                 | 42375-3746         |      |                 |            |

| ENG. NO: 42375-3764/3798 |             |                    |             |
|--------------------------|-------------|--------------------|-------------|
| HEADER NUMBER:           |             | 42312-0036         |             |
| PIN NUMBER:              |             | 42663-ETA154       |             |
| PIN LENGTH: L            |             | .540 / 13.72       |             |
| MATING LENGTH: M         |             | .250 / 6.35        |             |
| GOLD POINT: G            |             | .140 / 3.56        |             |
| PC TAIL LENGTH: P        |             | .200 / 5.08        |             |
| TIN: T                   |             | .135 / 3.43        |             |
| CKTS:                    |             | 2-36               |             |
| KINKS:                   |             | NO                 |             |
| VOIDED CKTS:             |             | 5                  |             |
| PACKAGING:               |             | BULK PK-40873-0041 |             |
| CKTS                     | ITEM NUMBER | CKTS               | ITEM NUMBER |
| 2                        |             | 20                 |             |
| 3                        |             | 21                 |             |
| 4                        |             | 22                 |             |
| 5                        |             | 23                 |             |
| 6                        |             | 24                 |             |
| 7                        |             | 25                 |             |
| 8                        | 68300-2007  | 26                 |             |
| 9                        |             | 27                 |             |
| 10                       |             | 28                 |             |
| 11                       |             | 29                 |             |
| 12                       |             | 30                 |             |
| 13                       |             | 31                 |             |
| 14                       |             | 32                 |             |
| 15                       |             | 33                 |             |
| 16                       |             | 34                 |             |
| 17                       |             | 35                 |             |
| 18                       |             | 36                 |             |
| 19                       |             |                    |             |

DOCUMENT STATUS P1 RELEASE DATE 2021/12/20 12:18:33

|                 |   |                        |  |
|-----------------|---|------------------------|--|
| SYMBOLS         | THIS DRAWING CONTAINS INFORMATION THAT IS PROPRIETARY TO MOLEX ELECTRONIC TECHNOLOGIES, LLC AND SHOULD NOT BE USED WITHOUT WRITTEN PERMISSION |                        |  |
|                 | DIMENSION UNITS   | SCALE                  | CURRENT REV DESC: GOLD LENGTH SPEC CHANGED AS MIN 2.54- MAX 5.54 FOR A-42375-0037/0071   |
| ∇ = 0           | MM/IN   | 1:1                    | <br>KK 100 HEADER ASSY<br>FLAT VERTICAL BREAKAWAY<br>PRODUCT CUSTOMER DRAWING |
| ∇ = 0           | GENERAL TOLERANCES (UNLESS SPECIFIED)   |                        |  |
| ∇ = 0           |   |                        |  |
| ∇ = 0           | 4 PLACES ±  | ±                      |  |
| ∇ = 0           | 3 PLACES ±  | ± 0.01                 |  |
| ∇ = 0           | 2 PLACES ±  | ± 0.25                 | EC NO: 689596<br>DRWN: SHRUTJ 2021/09/14<br>CHK'D: SHRUTJ 2021/12/20<br>APPR: ISHWARG 2021/12/20   |
| ∇ = 0           | 1 PLACE ±   | ± 0.38                 | INITIAL REVISION:  |
| ∇ = 0           | 0 PLACES ±  | ±                      | DRWN: SCHAFFER 2003/02/11  |
| ∇ = 0           | ANGULAR TOL ±   | ± 0.5°                 | APPR: MARGULIS 2004/02/27  |
| ∇ = 0           | DRAFT WHERE APPLICABLE MUST REMAIN WITHIN DIMENSIONS  | THIRD ANGLE PROJECTION | DRAWING SERIES   |
| ∇ = 0           |   |                        | B-SIZE 42375   |
| DOCUMENT NUMBER |   | DOC TYPE               | DOC PART   |
| SD-42375-001    |   | PSD                    | 001  |
| MATERIAL NUMBER |   | CUSTOMER               | REVISION   |
| SEE CHART       |   | GENERAL MARKET         | V  |
| SHEET NUMBER    |   | 28 OF 35               |  |

| ENG. NO: 42375-3799/3832 |                 |                    |                 |
|--------------------------|-----------------|--------------------|-----------------|
| HEADER NUMBER:           |                 | 42312-0036         |                 |
| PIN NUMBER:              |                 | 42663-ABA154       |                 |
| PIN LENGTH: L            |                 | .455 / 11.56       |                 |
| MATING LENGTH: M         |                 | .240 / 6.09        |                 |
| GOLD POINT: G            |                 | N/A                |                 |
| PC TAIL LENGTH: P        |                 | .125 / 3.18        |                 |
| TIN: T                   |                 | OVERALL            |                 |
| CKTS:                    |                 | 3-36               |                 |
| KINKS:                   |                 | NO                 |                 |
| VOIDED CKTS:             |                 | 3                  |                 |
| PACKAGING:               |                 | BULK PK-40873-0041 |                 |
| CKTS                     | MATERIAL NUMBER | CKTS               | MATERIAL NUMBER |
| 2                        |                 | 20                 |                 |
| 3                        |                 | 21                 |                 |
| 4                        |                 | 22                 |                 |
| 5                        | 42375-3801      | 23                 |                 |
| 6                        |                 | 24                 |                 |
| 7                        |                 | 25                 |                 |
| 8                        |                 | 26                 |                 |
| 9                        |                 | 27                 |                 |
| 10                       |                 | 28                 |                 |
| 11                       |                 | 29                 |                 |
| 12                       |                 | 30                 |                 |
| 13                       |                 | 31                 |                 |
| 14                       |                 | 32                 |                 |
| 15                       |                 | 33                 |                 |
| 16                       |                 | 34                 |                 |
| 17                       |                 | 35                 |                 |
| 18                       |                 | 36                 |                 |
| 19                       |                 |                    |                 |

| ENG. NO: 42375-3733/3867 |                 |                    |                 |
|--------------------------|-----------------|--------------------|-----------------|
| HEADER NUMBER:           |                 | 42312-0036         |                 |
| PIN NUMBER:              |                 | 42663-ABB208       |                 |
| PIN LENGTH: L            |                 | .455 / 11.56       |                 |
| MATING LENGTH: M         |                 | .250 / 6.35        |                 |
| GOLD POINT: G            |                 | .100 / 2.54        |                 |
| PC TAIL LENGTH: P        |                 | .115 / 2.92        |                 |
| TIN: T                   |                 | .100 / 2.54        |                 |
| CKTS:                    |                 | 2-36               |                 |
| KINKS:                   |                 | NO                 |                 |
| VOIDED CKTS:             |                 | NONE               |                 |
| PACKAGING:               |                 | BULK PK-40873-0041 |                 |
| CKTS                     | MATERIAL NUMBER | CKTS               | MATERIAL NUMBER |
| 2                        |                 | 20                 |                 |
| 3                        |                 | 21                 |                 |
| 4                        |                 | 22                 |                 |
| 5                        | 42375-3836      | 23                 |                 |
| 6                        |                 | 24                 |                 |
| 7                        |                 | 25                 |                 |
| 8                        |                 | 26                 |                 |
| 9                        |                 | 27                 |                 |
| 10                       |                 | 28                 |                 |
| 11                       |                 | 29                 |                 |
| 12                       |                 | 30                 |                 |
| 13                       |                 | 31                 |                 |
| 14                       |                 | 32                 |                 |
| 15                       |                 | 33                 |                 |
| 16                       |                 | 34                 |                 |
| 17                       |                 | 35                 |                 |
| 18                       |                 | 36                 |                 |
| 19                       |                 |                    |                 |

| ENG. NO: 42375-3868 / 3902 |             |                    |             |
|----------------------------|-------------|--------------------|-------------|
| HEADER NUMBER:             |             | 42312-0036         |             |
| PIN NUMBER:                |             | 42663-DWA154       |             |
| PIN LENGTH: L              |             | .850 / 21.59       |             |
| MATING LENGTH: M           |             | .640 / 16.26       |             |
| GOLD POINT: G              |             | N/A                |             |
| PC TAIL LENGTH: P          |             | .120 / 3.05        |             |
| TIN: T                     |             | OVERALL            |             |
| CKTS:                      |             | 2-36               |             |
| KINKS:                     |             | NO                 |             |
| VOIDED CKTS:               |             | NONE               |             |
| PACKAGING:                 |             | BULK PK-40873-0041 |             |
| CKTS                       | ITEM NUMBER | CKTS               | ITEM NUMBER |
| 2                          |             | 20                 |             |
| 3                          |             | 21                 |             |
| 4                          | 42375-3870  | 22                 |             |
| 5                          |             | 23                 |             |
| 6                          | 42375-3872  | 24                 |             |
| 7                          |             | 25                 |             |
| 8                          |             | 26                 |             |
| 9                          |             | 27                 |             |
| 10                         |             | 28                 |             |
| 11                         |             | 29                 |             |
| 12                         |             | 30                 |             |
| 13                         |             | 31                 |             |
| 14                         |             | 32                 |             |
| 15                         |             | 33                 |             |
| 16                         |             | 34                 |             |
| 17                         |             | 35                 |             |
| 18                         |             | 36                 |             |
| 19                         |             |                    |             |

| <b>SYMBOLS</b><br>= 0<br>= 0<br>= 0<br>= 0<br>= 0<br>= 0<br>= 0<br>= 0<br>= 0 | THIS DRAWING CONTAINS INFORMATION THAT IS PROPRIETARY TO MOLEX ELECTRONIC TECHNOLOGIES, LLC AND SHOULD NOT BE USED WITHOUT WRITTEN PERMISSION  |   | CURRENT REV DESC: GOLD LENGTH SPEC<br>CHANGED AS MIN 2.54- MAX 5.54 FOR<br>A-42375-0037/0071 |    | <br><br>KK 100 HEADER ASSY<br>FLAT VERTICAL BREAKAWAY<br><br>PRODUCT CUSTOMER DRAWING |   |      |            |  |  |            |  |        |            |      |  |           |      |  |            |  |  |   |
|---|--|---|--|----|---|---|------|------------|--|--|------------|--|--------|------------|------|--|-----------|------|--|------------|--|--|---|
|   | DIMENSION UNITS: <b>MM/IN</b> SCALE: <b>1:1</b>  |   | GENERAL TOLERANCES<br>(UNLESS SPECIFIED)   |    |   | EC NO: 689596<br>DRWN: SHRUTJ      2021/09/14<br>CHK'D: SHRUTJ      2021/12/20<br>APPR: ISHWARG      2021/12/20 |      |            |  |  |            |  |        |            |      |  |           |      |  |            |  |  |   |
|   | <table border="1"> <tr><th></th><th>MM</th><th>INCH</th></tr> <tr><td>4 PLACES ±</td><td></td><td></td></tr> <tr><td>3 PLACES ±</td><td></td><td>± 0.01</td></tr> <tr><td>2 PLACES ±</td><td>0.25</td><td></td></tr> <tr><td>1 PLACE ±</td><td>0.38</td><td></td></tr> <tr><td>0 PLACES ±</td><td></td><td></td></tr> </table> |   |  | MM |   |   | INCH | 4 PLACES ± |  |  | 3 PLACES ± |  | ± 0.01 | 2 PLACES ± | 0.25 |  | 1 PLACE ± | 0.38 |  | 0 PLACES ± |  |  | INITIAL REVISION:<br>DRWN: SCHAFFER      2003/02/11<br>APPR: MARGULIS      2004/02/27 |
|   |  | MM  | INCH   |    |   |   |      |            |  |  |            |  |        |            |      |  |           |      |  |            |  |  |   |
|   | 4 PLACES ±   |   |  |    |   |   |      |            |  |  |            |  |        |            |      |  |           |      |  |            |  |  |   |
|   | 3 PLACES ±   |   | ± 0.01   |    |   |   |      |            |  |  |            |  |        |            |      |  |           |      |  |            |  |  |   |
|   | 2 PLACES ±   | 0.25  |  |    |   |   |      |            |  |  |            |  |        |            |      |  |           |      |  |            |  |  |   |
|   | 1 PLACE ±  | 0.38  |  |    |   |   |      |            |  |  |            |  |        |            |      |  |           |      |  |            |  |  |   |
|   | 0 PLACES ±   |   |  |    |   |   |      |            |  |  |            |  |        |            |      |  |           |      |  |            |  |  |   |
|   | ANGULAR TOL ± 0.5°   |   | DRAFT WHERE APPLICABLE<br>MUST REMAIN<br>WITHIN DIMENSIONS                                   |    |   | DOCUMENT NUMBER: <b>SD-42375-001</b><br>DOC TYPE: PSD    DOC PART: 001    REVISION: V                           |      |            |  |  |            |  |        |            |      |  |           |      |  |            |  |  |   |
| THIRD ANGLE PROJECTION<br>  |  | DRAWING: <b>B-SIZE</b> SERIES: <b>42375</b><br>MATERIAL NUMBER: SEE CHART    CUSTOMER: GENERAL MARKET    SHEET NUMBER: 29 OF 35 |  |    |   |   |      |            |  |  |            |  |        |            |      |  |           |      |  |            |  |  |   |
| DOCUMENT STATUS: P1    RELEASE DATE: 2021/12/20    12:18:33                   |  |   |  |    |   |   |      |            |  |  |            |  |        |            |      |  |           |      |  |            |  |  |   |

| ENG. NO: 42375-3903/3932 |                 |                    |                 |
|--------------------------|-----------------|--------------------|-----------------|
| HEADER NUMBER:           |                 | 42312-0036         |                 |
| PIN NUMBER:              |                 | 42663-BSA154       |                 |
| PIN LENGTH: L            |                 | .630 / 16.00       |                 |
| MATING LENGTH: M         |                 | .421 / 10.69       |                 |
| GOLD POINT: G            |                 | N/A                |                 |
| PC TAIL LENGTH: P        |                 | .119 / 3.02        |                 |
| TIN: T                   |                 | OVERALL            |                 |
| CKTS:                    |                 | 7-36               |                 |
| KINKS:                   |                 | NO                 |                 |
| VOIDED CKTS:             |                 | 7                  |                 |
| PACKAGING:               |                 | BULK PK-40873-0041 |                 |
| CKTS                     | MATERIAL NUMBER | CKTS               | MATERIAL NUMBER |
| 2                        |                 | 20                 |                 |
| 3                        |                 | 21                 |                 |
| 4                        |                 | 22                 |                 |
| 5                        |                 | 23                 |                 |
| 6                        |                 | 24                 |                 |
| 7                        |                 | 25                 |                 |
| 8                        | 42375-3904      | 26                 |                 |
| 9                        |                 | 27                 |                 |
| 10                       |                 | 28                 |                 |
| 11                       |                 | 29                 |                 |
| 12                       |                 | 30                 |                 |
| 13                       |                 | 31                 |                 |
| 14                       |                 | 32                 |                 |
| 15                       |                 | 33                 |                 |
| 16                       |                 | 34                 |                 |
| 17                       |                 | 35                 |                 |
| 18                       |                 | 36                 |                 |
| 19                       |                 |                    |                 |

| ENG. NO: 42375-3933/3964 |                 |                    |                 |
|--------------------------|-----------------|--------------------|-----------------|
| HEADER NUMBER:           |                 | 42312-0036         |                 |
| PIN NUMBER:              |                 | 42663-BSA154       |                 |
| PIN LENGTH: L            |                 | .630 / 16.00       |                 |
| MATING LENGTH: M         |                 | .405/10.29         |                 |
| GOLD POINT: G            |                 | N/A                |                 |
| PC TAIL LENGTH: P        |                 | .135/3.43          |                 |
| TIN: T                   |                 | OVERALL            |                 |
| CKTS:                    |                 | 5-36               |                 |
| KINKS:                   |                 | SMES-42003         |                 |
| VOIDED CKTS:             |                 | 5                  |                 |
| PACKAGING:               |                 | BULK PK-40873-0041 |                 |
| CKTS                     | MATERIAL NUMBER | CKTS               | MATERIAL NUMBER |
| 2                        |                 | 20                 |                 |
| 3                        |                 | 21                 |                 |
| 4                        |                 | 22                 |                 |
| 5                        |                 | 23                 |                 |
| 6                        |                 | 24                 |                 |
| 7                        |                 | 25                 |                 |
| 8                        |                 | 26                 |                 |
| 9                        | 42375-3937      | 27                 |                 |
| 10                       |                 | 28                 |                 |
| 11                       |                 | 29                 |                 |
| 12                       |                 | 30                 |                 |
| 13                       |                 | 31                 |                 |
| 14                       |                 | 32                 |                 |
| 15                       |                 | 33                 |                 |
| 16                       |                 | 34                 |                 |
| 17                       |                 | 35                 |                 |
| 18                       |                 | 36                 |                 |
| 19                       |                 |                    |                 |

| ENG. NO: 42375-3965/3995 |                 |                    |                 |
|--------------------------|-----------------|--------------------|-----------------|
| HEADER NUMBER:           |                 | 42312-0036         |                 |
| PIN NUMBER:              |                 | 42663-BSA154       |                 |
| PIN LENGTH: L            |                 | .630 / 16.00       |                 |
| MATING LENGTH: M         |                 | .405/10.29         |                 |
| GOLD POINT: G            |                 | N/A                |                 |
| PC TAIL LENGTH: P        |                 | .135/3.43          |                 |
| TIN: T                   |                 | OVERALL            |                 |
| CKTS:                    |                 | 6-36               |                 |
| KINKS:                   |                 | SMES-42003         |                 |
| VOIDED CKTS:             |                 | 4, 5, 6            |                 |
| PACKAGING:               |                 | BULK PK-40873-0041 |                 |
| CKTS                     | MATERIAL NUMBER | CKTS               | MATERIAL NUMBER |
| 2                        |                 | 20                 |                 |
| 3                        |                 | 21                 |                 |
| 4                        |                 | 22                 |                 |
| 5                        |                 | 23                 |                 |
| 6                        |                 | 24                 |                 |
| 7                        |                 | 25                 |                 |
| 8                        |                 | 26                 |                 |
| 9                        | 42375-3968      | 27                 |                 |
| 10                       |                 | 28                 |                 |
| 11                       |                 | 29                 |                 |
| 12                       |                 | 30                 |                 |
| 13                       |                 | 31                 |                 |
| 14                       |                 | 32                 |                 |
| 15                       |                 | 33                 |                 |
| 16                       |                 | 34                 |                 |
| 17                       |                 | 35                 |                 |
| 18                       |                 | 36                 |                 |
| 19                       |                 |                    |                 |

|                 |    |              |            |          |
|-----------------|----|--------------|------------|----------|
| DOCUMENT STATUS | P1 | RELEASE DATE | 2021/12/20 | 12:18:33 |
|-----------------|----|--------------|------------|----------|

|         |   |        |  |                          |
|---------|---|--------|--|--------------------------|
| SYMBOLS | THIS DRAWING CONTAINS INFORMATION THAT IS PROPRIETARY TO MOLEX ELECTRONIC TECHNOLOGIES, LLC AND SHOULD NOT BE USED WITHOUT WRITTEN PERMISSION |        |  |                          |
|         | DIMENSION UNITS   | SCALE  | CURRENT REV DESC: GOLD LENGTH SPEC CHANGED AS MIN 2.54- MAX 5.54 FOR A-42375-0037/0071   |                          |
| ▽ = 0   | MM/IN   | 1:1    | <br>KK 100 HEADER ASSY<br>FLAT VERTICAL BREAKAWAY<br>PRODUCT CUSTOMER DRAWING |                          |
| ▽ = 0   | GENERAL TOLERANCES (UNLESS SPECIFIED)   |        |  |                          |
| ▽ = 0   |   |        |  |                          |
| ▽ = 0   |   |        |  |                          |
| ▽ = 0   | 4 PLACES ±  | ±      | EC NO: 689596  | DRWN: SHRUTJ 2021/09/14  |
| ▽ = 0   | 3 PLACES ±  | ± 0.01 | CHK'D: SHRUTJ 2021/12/20   | APPR: ISHWARG 2021/12/20 |
| ▽ = 0   | 2 PLACES ±  | ± 0.25 | INITIAL REVISION:  |                          |
| ▽ = 0   | 1 PLACE ±   | ± 0.38 | DRWN: SCHAFFER 2003/02/11  | 2004/02/27               |
| ▽ = 0   | 0 PLACES ±  | ±      | APPR: MARGULIS 2004/02/27  |                          |
| ▽ = 0   | ANGULAR TOL   | ± 0.5° | DOCUMENT NUMBER  |                          |
| ▽ = 0   | DRAFT WHERE APPLICABLE MUST REMAIN WITHIN DIMENSIONS  |        | THIRD ANGLE PROJECTION   | DRAWING                  |
| ▽ = 0   |   |        | SERIES   | REVISION                 |
|         |   |        | B-SIZE   | 42375                    |
|         |   |        | SEE CHART  | GENERAL MARKET           |
|         |   |        | MATERIAL NUMBER  | CUSTOMER                 |
|         |   |        | SD-42375-001   | PSD 001 V                |
|         |   |        | SHEET NUMBER   | 30 OF 35                 |

| ENG. NO: A-42375-3996/4030 |             |                    |             |
|----------------------------|-------------|--------------------|-------------|
| HEADER NUMBER:             |             | 42312-0036         |             |
| PIN NUMBER:                |             | 42663-AXA154       |             |
| PIN LENGTH: L              |             | .540 / 13.72       |             |
| MATING LENGTH: M           |             | .390 / 9.91        |             |
| GOLD POINT: G              |             | N/A                |             |
| PC TAIL LENGTH: P          |             | .060 / 1.52        |             |
| TIN: T                     |             | OVERALL            |             |
| CKTS:                      |             | 2-36               |             |
| KINKS:                     |             | NO                 |             |
| VOIDED CKTS:               |             | NONE               |             |
| PACKAGING:                 |             | BULK PK-40873-0041 |             |
| CKTS                       | ITEM NUMBER | CKTS               | ITEM NUMBER |
| 2                          |             | 20                 |             |
| 3                          |             | 21                 |             |
| 4                          |             | 22                 |             |
| 5                          |             | 23                 |             |
| 6                          | 42375-4000  | 24                 |             |
| 7                          | 42375-4001  | 25                 |             |
| 8                          |             | 26                 |             |
| 9                          |             | 27                 |             |
| 10                         |             | 28                 |             |
| 11                         |             | 29                 |             |
| 12                         |             | 30                 |             |
| 13                         |             | 31                 |             |
| 14                         |             | 32                 |             |
| 15                         |             | 33                 |             |
| 16                         |             | 34                 |             |
| 17                         |             | 35                 |             |
| 18                         |             | 36                 |             |
| 19                         |             |                    |             |

| ENG. NO: 42375-4031/4059 |                 |                    |                 |
|--------------------------|-----------------|--------------------|-----------------|
| HEADER NUMBER:           |                 | 42312-0036         |                 |
| PIN NUMBER:              |                 | 42663-ABA154       |                 |
| PIN LENGTH: L            |                 | .455 / 11.56       |                 |
| MATING LENGTH: M         |                 | .240 / 6.09        |                 |
| GOLD POINT: G            |                 | N/A                |                 |
| PC TAIL LENGTH: P        |                 | .125 / 3.18        |                 |
| TIN: T                   |                 | OVERALL            |                 |
| CKTS:                    |                 | 8-36               |                 |
| KINKS:                   |                 | NO                 |                 |
| VOIDED CKTS:             |                 | 2, 4, 6, 8         |                 |
| PACKAGING:               |                 | BULK PK-40873-0041 |                 |
| CKTS                     | MATERIAL NUMBER | CKTS               | MATERIAL NUMBER |
| 2                        |                 | 20                 |                 |
| 3                        |                 | 21                 |                 |
| 4                        |                 | 22                 |                 |
| 5                        |                 | 23                 |                 |
| 6                        |                 | 24                 |                 |
| 7                        |                 | 25                 |                 |
| 8                        |                 | 26                 |                 |
| 9                        | 42375-4032      | 27                 |                 |
| 10                       |                 | 28                 |                 |
| 11                       |                 | 29                 |                 |
| 12                       |                 | 30                 |                 |
| 13                       |                 | 31                 |                 |
| 14                       |                 | 32                 |                 |
| 15                       |                 | 33                 |                 |
| 16                       |                 | 34                 |                 |
| 17                       |                 | 35                 |                 |
| 18                       |                 | 36                 |                 |
| 19                       |                 |                    |                 |

| ENG. NO: 42375-4060 / 4094 |                 |                    |                 |
|----------------------------|-----------------|--------------------|-----------------|
| HEADER NUMBER:             |                 | 42312-0036         |                 |
| PIN NUMBER:                |                 | 42663-CGA154       |                 |
| PIN LENGTH: L              |                 | .690 / 17.53       |                 |
| MATING LENGTH: M           |                 | .521 / 13.23       |                 |
| GOLD POINT: G              |                 | N/A                |                 |
| PC TAIL LENGTH: P          |                 | .079 / 2.01        |                 |
| TIN: T                     |                 | OVERALL            |                 |
| CKTS:                      |                 | 2-36               |                 |
| KINKS:                     |                 | NO                 |                 |
| VOIDED CKTS:               |                 | NONE               |                 |
| PACKAGING:                 |                 | BULK PK-40873-0041 |                 |
| CKTS                       | MATERIAL NUMBER | CKTS               | MATERIAL NUMBER |
| 2                          |                 | 20                 |                 |
| 3                          |                 | 21                 |                 |
| 4                          |                 | 22                 |                 |
| 5                          |                 | 23                 |                 |
| 6                          | 42375-4064      | 24                 |                 |
| 7                          |                 | 25                 |                 |
| 8                          |                 | 26                 |                 |
| 9                          |                 | 27                 |                 |
| 10                         |                 | 28                 |                 |
| 11                         |                 | 29                 |                 |
| 12                         |                 | 30                 |                 |
| 13                         |                 | 31                 |                 |
| 14                         |                 | 32                 |                 |
| 15                         |                 | 33                 |                 |
| 16                         |                 | 34                 |                 |
| 17                         |                 | 35                 |                 |
| 18                         |                 | 36                 |                 |
| 19                         |                 |                    |                 |

DOCUMENT STATUS P1 RELEASE DATE 2021/12/20 12:18:33

|  |   |                     |  |   |   |  |
|--|---|---------------------|--|---|---|--|
| <b>SYMBOLS</b><br>= 0<br>= 0<br>= 0<br>= 0<br>= 0<br>= 0<br>= 0<br>= 0 | THIS DRAWING CONTAINS INFORMATION THAT IS PROPRIETARY TO MOLEX ELECTRONIC TECHNOLOGIES, LLC AND SHOULD NOT BE USED WITHOUT WRITTEN PERMISSION |                     | CURRENT REV DESC: GOLD LENGTH SPEC CHANGED AS MIN 2.54- MAX 5.54 FOR A-42375-0037/0071           |   | <br><br>KK 100 HEADER ASSY<br>FLAT VERTICAL BREAKAWAY<br><br>PRODUCT CUSTOMER DRAWING |  |
|  | DIMENSION UNITS<br><b>MM/IN</b>   | SCALE<br><b>1:1</b> | GENERAL TOLERANCES (UNLESS SPECIFIED)  |   |   | DOCUMENT NUMBER<br><b>SD-42375-001</b>                                     |
|  | 4 PLACES ±<br>3 PLACES ±<br>2 PLACES ± 0.25 ±<br>1 PLACE ± 0.38 ±<br>0 PLACES ±   |                     | EC NO: 689596<br>DRWN: SHRUTJ 2021/09/14<br>CHK'D: SHRUTJ 2021/12/20<br>APPR: ISHWARG 2021/12/20 | INITIAL REVISION:<br>DRWN: SCHAFFER 2003/02/11<br>APPR: MARGULIS 2004/02/27 |   | DOC TYPE DOC PART REVISION<br>PSD 001 V                                    |
|  | ANGULAR TOL ± 0.5°<br>DRAFT WHERE APPLICABLE MUST REMAIN WITHIN DIMENSIONS  |                     | THIRD ANGLE PROJECTION<br>   | DRAWING SERIES<br><b>B-SIZE 42375</b>                                       |   | MATERIAL NUMBER CUSTOMER SHEET NUMBER<br>SEE CHART GENERAL MARKET 31 OF 35 |

| ENG. NO: A-42375-4095/4129 |             |                    |             |
|----------------------------|-------------|--------------------|-------------|
| HEADER NUMBER:             |             | 42312-0036         |             |
| PIN NUMBER:                |             | 42663-DEB228       |             |
| PIN LENGTH: L              |             | .785 / 19.94       |             |
| MATING LENGTH: M           |             | .470 / 11.94       |             |
| GOLD POINT: G              |             | .250 / 6.35        |             |
| PC TAIL LENGTH: P          |             | .225 / 5.72        |             |
| TIN: T                     |             | .200 / 5.08        |             |
| CKTS:                      |             | 2-36               |             |
| KINKS:                     |             | NO                 |             |
| VOIDED CKTS:               |             | NONE               |             |
| PACKAGING:                 |             | BULK PK-40873-0041 |             |
| CKTS                       | ITEM NUMBER | CKTS               | ITEM NUMBER |
| 2                          |             | 20                 |             |
| 3                          |             | 21                 |             |
| 4                          |             | 22                 |             |
| 5                          |             | 23                 |             |
| 6                          |             | 24                 |             |
| 7                          |             | 25                 |             |
| 8                          |             | 26                 |             |
| 9                          |             | 27                 |             |
| 10                         | 42375-4103  | 28                 |             |
| 11                         |             | 29                 |             |
| 12                         |             | 30                 |             |
| 13                         |             | 31                 |             |
| 14                         |             | 32                 |             |
| 15                         |             | 33                 |             |
| 16                         |             | 34                 |             |
| 17                         |             | 35                 |             |
| 18                         | 42375-4111  | 36                 |             |
| 19                         |             |                    |             |

| ENG. NO: A-42375-4130/4161 |             |                    |             |
|----------------------------|-------------|--------------------|-------------|
| HEADER NUMBER:             |             | 42312-0036         |             |
| PIN NUMBER:                |             | 42663-ATA154       |             |
| PIN LENGTH: L              |             | 530/13.46          |             |
| MATING LENGTH: M           |             | .320/8.13          |             |
| GOLD POINT: G              |             | N/A                |             |
| PC TAIL LENGTH: P          |             | .120/3.05          |             |
| TIN: T                     |             | OVERALL            |             |
| CKTS:                      |             | 5-36               |             |
| KINKS:                     |             | SMES-42003         |             |
| VOIDED CKTS:               |             | 2, 3, 4            |             |
| PACKAGING:                 |             | BULK PK-40873-0041 |             |
| CKTS                       | ITEM NUMBER | CKTS               | ITEM NUMBER |
|                            |             | 20                 |             |
|                            |             | 21                 |             |
|                            |             | 22                 |             |
| 5                          | 42375-4130  | 23                 |             |
| 6                          |             | 24                 |             |
| 7                          |             | 25                 |             |
| 8                          |             | 26                 |             |
| 9                          |             | 27                 |             |
| 10                         |             | 28                 |             |
| 11                         |             | 29                 |             |
| 12                         |             | 30                 |             |
| 13                         |             | 31                 |             |
| 14                         |             | 32                 |             |
| 15                         |             | 33                 |             |
| 16                         |             | 34                 |             |
| 17                         |             | 35                 |             |
| 18                         |             | 36                 |             |
| 19                         |             |                    |             |

| ENG. NO: 42375-4162/4196 |                 |                    |                 |
|--------------------------|-----------------|--------------------|-----------------|
| HEADER NUMBER:           |                 | 42312-0036         |                 |
| PIN NUMBER:              |                 | 42663-BSC228       |                 |
| PIN LENGTH: L            |                 | .630/16.00         |                 |
| MATING LENGTH: M         |                 | .400/10.16         |                 |
| GOLD POINT: G            |                 | .345/8.76          |                 |
| PC TAIL LENGTH: P        |                 | 140/3.56           |                 |
| TIN: T                   |                 | .100/2.54          |                 |
| CKTS:                    |                 | 2-36               |                 |
| KINKS:                   |                 | NO                 |                 |
| VOIDED CKTS:             |                 | NONE               |                 |
| PACKAGING:               |                 | BULK PK-40873-0041 |                 |
| CKTS                     | MATERIAL NUMBER | CKTS               | MATERIAL NUMBER |
| 2                        |                 | 20                 |                 |
| 3                        |                 | 21                 |                 |
| 4                        | 42375-4164      | 22                 |                 |
| 5                        | 42375-4165      | 23                 |                 |
| 6                        |                 | 24                 |                 |
| 7                        |                 | 25                 |                 |
| 8                        |                 | 26                 |                 |
| 9                        |                 | 27                 |                 |
| 10                       | 42375-4170      | 28                 |                 |
| 11                       |                 | 29                 |                 |
| 12                       |                 | 30                 |                 |
| 13                       |                 | 31                 |                 |
| 14                       |                 | 32                 |                 |
| 15                       |                 | 33                 |                 |
| 16                       |                 | 34                 |                 |
| 17                       |                 | 35                 |                 |
| 18                       |                 | 36                 |                 |
| 19                       |                 |                    |                 |

|   |   |  |  |  |   |   |
|---|---|--|--|--|---|---|
| <b>SYMBOLS</b><br>= 0<br>= 0<br>= 0<br>= 0<br>= 0<br>= 0<br>= 0<br>= 0<br>= 0 | THIS DRAWING CONTAINS INFORMATION THAT IS PROPRIETARY TO MOLEX ELECTRONIC TECHNOLOGIES, LLC AND SHOULD NOT BE USED WITHOUT WRITTEN PERMISSION |  | CURRENT REV DESC: GOLD LENGTH SPEC CHANGED AS MIN 2.54- MAX 5.54 FOR A-42375-0037/0071 |  | <br><br>KK 100 HEADER ASSY<br>FLAT VERTICAL BREAKAWAY<br><br>PRODUCT CUSTOMER DRAWING |   |
|   | DIMENSION UNITS: <b>MM/IN</b> SCALE: <b>1:1</b>   |  | GENERAL TOLERANCES (UNLESS SPECIFIED)  |  |   | EC NO: 689596<br>DRWN: SHRUTJ      2021/09/14<br>CHK'D: SHRUTJ      2021/12/20<br>APPR: ISHWARG      2021/12/20 |
|   | 4 PLACES ±      ±<br>3 PLACES ±      ± 0.01<br>2 PLACES ± 0.25 ±<br>1 PLACE ± 0.38 ±<br>0 PLACES ±      ±                                     |  | INITIAL REVISION:<br>DRWN: SCHAFFER      2003/02/11<br>APPR: MARGULIS      2004/02/27  |  |   |   |
|   | ANGULAR TOL ± 0.5°  |  | DRAFT WHERE APPLICABLE MUST REMAIN WITHIN DIMENSIONS                                   |  |   | DOCUMENT NUMBER: <b>SD-42375-001</b> DOC TYPE: PSD      DOC PART: 001      REVISION: V                          |
|   | THIRD ANGLE PROJECTION  |  | DRAWING: <b>B-SIZE</b> SERIES: <b>42375</b>  |  |   | MATERIAL NUMBER: SEE CHART      CUSTOMER: GENERAL MARKET      SHEET NUMBER: 32 OF 35                            |



| ENG. NO: A-42375-1622 |                    |      |                 |
|-----------------------|--------------------|------|-----------------|
| HEADER NUMBER:        | 42312-0036         |      |                 |
| PIN NUMBER:           | 42663-AYB208       |      |                 |
| PIN LENGTH: L         | .545 / 13.84       |      |                 |
| MATING LENGTH: M      | .320 / 8.13        |      |                 |
| GOLD POINT: G         | .140 / 3.56        |      |                 |
| PC TAIL LENGTH: P     | .135 / 3.43        |      |                 |
| TIN: T                | .135 / 3.43        |      |                 |
| CKTS:                 | 2-36               |      |                 |
| KINKS:                | SMES-42003         |      |                 |
| VOIDED CKTS:          | 3                  |      |                 |
| PACKAGING:            | BULK PK-40873-0041 |      |                 |
| CKTS                  | MATERIAL NUMBER    | CKTS | MATERIAL NUMBER |
| 2                     |                    | 20   |                 |
| 3                     |                    | 21   |                 |
| 4                     |                    | 22   |                 |
| 5                     |                    | 23   |                 |
| 6                     |                    | 24   |                 |
| 7                     |                    | 25   |                 |
| 8                     |                    | 26   |                 |
| 9                     | 42375-1622         | 27   |                 |
| 10                    |                    | 28   |                 |
| 11                    |                    | 29   |                 |
| 12                    |                    | 30   |                 |
| 13                    |                    | 31   |                 |
| 14                    |                    | 32   |                 |
| 15                    |                    | 33   |                 |
| 16                    |                    | 34   |                 |
| 17                    |                    | 35   |                 |
| 18                    |                    | 36   |                 |
| 19                    |                    |      |                 |

| ENG. NO: A-42375-4199 |                    |      |                 |
|-----------------------|--------------------|------|-----------------|
| HEADER NUMBER:        | 42312-0036         |      |                 |
| PIN NUMBER:           | 42663-ARB228       |      |                 |
| PIN LENGTH: L         | .520 / 13.21       |      |                 |
| MATING LENGTH: M      | .230 / 5.84        |      |                 |
| GOLD POINT: G         | .140 / 3.56        |      |                 |
| PC TAIL LENGTH: P     | .200 / 5.08        |      |                 |
| TIN: T                | .135 / 3.43        |      |                 |
| CKTS:                 | 2-36               |      |                 |
| KINKS:                | NO                 |      |                 |
| VOIDED CKTS:          | NONE               |      |                 |
| PACKAGING:            | BULK PK-40873-0041 |      |                 |
| CKTS                  | MATERIAL NUMBER    | CKTS | MATERIAL NUMBER |
| 2                     | 42375-4199         | 20   |                 |
| 3                     |                    | 21   |                 |
| 4                     |                    | 22   |                 |
| 5                     |                    | 23   |                 |
| 6                     |                    | 24   |                 |
| 7                     |                    | 25   |                 |
| 8                     |                    | 26   |                 |
| 9                     |                    | 27   |                 |
| 10                    |                    | 28   |                 |
| 11                    |                    | 29   |                 |
| 12                    |                    | 30   |                 |
| 13                    |                    | 31   |                 |
| 14                    |                    | 32   |                 |
| 15                    |                    | 33   |                 |
| 16                    |                    | 34   |                 |
| 17                    |                    | 35   |                 |
| 18                    |                    | 36   |                 |
| 19                    |                    |      |                 |

| ENG. NO: A-42375-4200 |                    |      |                 |
|-----------------------|--------------------|------|-----------------|
| HEADER NUMBER:        | 42312-0036         |      |                 |
| PIN NUMBER:           | 42663-ADB208       |      |                 |
| PIN LENGTH: L         | .465 / 11.81       |      |                 |
| MATING LENGTH: M      | .240 / 6.09        |      |                 |
| GOLD POINT: G         | .100 / 2.54        |      |                 |
| PC TAIL LENGTH: P     | .135 / 3.43        |      |                 |
| TIN: T                | .100 / 2.54        |      |                 |
| CKTS:                 | 2-36               |      |                 |
| KINKS:                | SMES-42003         |      |                 |
| VOIDED CKTS:          | 3, 4               |      |                 |
| PACKAGING:            | BULK PK-40873-0041 |      |                 |
| CKTS                  | MATERIAL NUMBER    | CKTS | MATERIAL NUMBER |
| 2                     |                    | 20   |                 |
| 3                     |                    | 21   |                 |
| 4                     |                    | 22   |                 |
| 5                     | 42375-4200         | 23   |                 |
| 6                     |                    | 24   |                 |
| 7                     |                    | 25   |                 |
| 8                     |                    | 26   |                 |
| 9                     |                    | 27   |                 |
| 10                    |                    | 28   |                 |
| 11                    |                    | 29   |                 |
| 12                    |                    | 30   |                 |
| 13                    |                    | 31   |                 |
| 14                    |                    | 32   |                 |
| 15                    |                    | 33   |                 |
| 16                    |                    | 34   |                 |
| 17                    |                    | 35   |                 |
| 18                    |                    | 36   |                 |
| 19                    |                    |      |                 |

|                 |    |              |            |          |
|-----------------|----|--------------|------------|----------|
| DOCUMENT STATUS | P1 | RELEASE DATE | 2021/12/20 | 12:18:33 |
|-----------------|----|--------------|------------|----------|

| <b>SYMBOLS</b><br>= 0<br>= 0<br>= 0<br>= 0<br>= 0<br>= 0<br>= 0<br>= 0<br>= 0 | THIS DRAWING CONTAINS INFORMATION THAT IS PROPRIETARY TO MOLEX ELECTRONIC TECHNOLOGIES, LLC AND SHOULD NOT BE USED WITHOUT WRITTEN PERMISSION  |                          | CURRENT REV DESC: GOLD LENGTH SPEC<br>CHANGED AS MIN 2.54- MAX 5.54 FOR<br>A-42375-0037/0071 |   | <br><br>KK 100 HEADER ASSY<br>FLAT VERTICAL BREAKAWAY<br><br>PRODUCT CUSTOMER DRAWING |  |      |            |  |  |            |  |        |            |        |  |           |        |  |            |  |  |   |
|---|--|--------------------------|--|---|---|--|------|------------|--|--|------------|--|--------|------------|--------|--|-----------|--------|--|------------|--|--|---|
|   | DIMENSION UNITS: <b>MM/IN</b><br>SCALE: <b>1:1</b>   |                          | GENERAL TOLERANCES<br>(UNLESS SPECIFIED)   |   |   | EC NO: 689596<br>DRWN: SHRUTJ 2021/09/14<br>CHK'D: SHRUTJ 2021/12/20<br>APPR: ISHWARG 2021/12/20 |      |            |  |  |            |  |        |            |        |  |           |        |  |            |  |  |   |
|   | <table border="1"> <tr><th></th><th>MM</th><th>INCH</th></tr> <tr><td>4 PLACES ±</td><td></td><td></td></tr> <tr><td>3 PLACES ±</td><td></td><td>± 0.01</td></tr> <tr><td>2 PLACES ±</td><td>± 0.25</td><td></td></tr> <tr><td>1 PLACE ±</td><td>± 0.38</td><td></td></tr> <tr><td>0 PLACES ±</td><td></td><td></td></tr> </table> |                          |  | MM  |   |  | INCH | 4 PLACES ± |  |  | 3 PLACES ± |  | ± 0.01 | 2 PLACES ± | ± 0.25 |  | 1 PLACE ± | ± 0.38 |  | 0 PLACES ± |  |  | INITIAL REVISION:<br>DRWN: SCHAFFER 2003/02/11<br>APPR: MARGULIS 2004/02/27 |
|   |  | MM                       | INCH   |   |   |  |      |            |  |  |            |  |        |            |        |  |           |        |  |            |  |  |   |
|   | 4 PLACES ±   |                          |  |   |   |  |      |            |  |  |            |  |        |            |        |  |           |        |  |            |  |  |   |
|   | 3 PLACES ±   |                          | ± 0.01   |   |   |  |      |            |  |  |            |  |        |            |        |  |           |        |  |            |  |  |   |
|   | 2 PLACES ±   | ± 0.25                   |  |   |   |  |      |            |  |  |            |  |        |            |        |  |           |        |  |            |  |  |   |
|   | 1 PLACE ±  | ± 0.38                   |  |   |   |  |      |            |  |  |            |  |        |            |        |  |           |        |  |            |  |  |   |
|   | 0 PLACES ±   |                          |  |   |   |  |      |            |  |  |            |  |        |            |        |  |           |        |  |            |  |  |   |
|   | ANGULAR TOL ± 0.5°   |                          | DRAFT WHERE APPLICABLE<br>MUST REMAIN<br>WITHIN DIMENSIONS                                   |   |   | THIRD ANGLE PROJECTION<br>   |      |            |  |  |            |  |        |            |        |  |           |        |  |            |  |  |   |
| DRAWING: <b>B-SIZE</b>  |  | SERIES: <b>42375</b>     |  | DOCUMENT NUMBER: <b>SD-42375-001</b><br>DOC TYPE: PSD<br>DOC PART: 001<br>REVISION: V |   |  |      |            |  |  |            |  |        |            |        |  |           |        |  |            |  |  |   |
| MATERIAL NUMBER: SEE CHART  |  | CUSTOMER: GENERAL MARKET |  | SHEET NUMBER: 33 OF 35  |   |  |      |            |  |  |            |  |        |            |        |  |           |        |  |            |  |  |   |

| ENG. NO: 42375-4236 |                 |                    |                 |
|---------------------|-----------------|--------------------|-----------------|
| HEADER NUMBER:      |                 | 42312-0036         |                 |
| PIN NUMBER:         |                 | 42663-CCA118       |                 |
| PIN LENGTH: L       |                 | .670 / 17.02       |                 |
| MATING LENGTH: M    |                 | .440 / 11.18       |                 |
| GOLD POINT: G       |                 | NA                 |                 |
| PC TAIL LENGTH: P   |                 | .140 / 3.56        |                 |
| TIN: T              |                 | OVERALL            |                 |
| CKTS:               |                 | 2-36               |                 |
| KINKS:              |                 | SMES-42003         |                 |
| VOIDED CKTS:        |                 | NONE               |                 |
| PACKAGING:          |                 | BULK PK-40873-0041 |                 |
| CKTS                | MATERIAL NUMBER | CKTS               | MATERIAL NUMBER |
| 2                   |                 | 20                 |                 |
| 3                   |                 | 21                 |                 |
| 4                   |                 | 22                 |                 |
| 5                   |                 | 23                 |                 |
| 6                   | 42375-4236      | 24                 |                 |
| 7                   |                 | 25                 |                 |
| 8                   |                 | 26                 |                 |
| 9                   |                 | 27                 |                 |
| 10                  |                 | 28                 |                 |
| 11                  |                 | 29                 |                 |
| 12                  |                 | 30                 |                 |
| 13                  |                 | 31                 |                 |
| 14                  |                 | 32                 |                 |
| 15                  |                 | 33                 |                 |
| 16                  |                 | 34                 |                 |
| 17                  |                 | 35                 |                 |
| 18                  |                 | 36                 |                 |
| 19                  |                 |                    |                 |

| ENG. NO: 42375-4305 |                 |                    |                 |
|---------------------|-----------------|--------------------|-----------------|
| HEADER NUMBER:      |                 | 42312-0036         |                 |
| PIN NUMBER:         |                 | 42663-BDA154       |                 |
| PIN LENGTH: L       |                 | .570 / 14.48       |                 |
| MATING LENGTH: M    |                 | .339 / 8.61        |                 |
| GOLD POINT: G       |                 | N/A                |                 |
| PC TAIL LENGTH: P   |                 | .140 / 3.56        |                 |
| TIN: T              |                 | OVERALL            |                 |
| CKTS:               |                 | 2-36               |                 |
| KINKS:              |                 | NO                 |                 |
| VOIDED CKTS:        |                 | NONE               |                 |
| PACKAGING:          |                 | BULK PK-40873-0041 |                 |
| CKTS                | MATERIAL NUMBER | CKTS               | MATERIAL NUMBER |
| 2                   |                 | 20                 |                 |
| 3                   |                 | 21                 |                 |
| 4                   |                 | 22                 |                 |
| 5                   | 42375-4305      | 23                 |                 |
| 6                   |                 | 24                 |                 |
| 7                   |                 | 25                 |                 |
| 8                   |                 | 26                 |                 |
| 9                   |                 | 27                 |                 |
| 10                  |                 | 28                 |                 |
| 11                  |                 | 29                 |                 |
| 12                  |                 | 30                 |                 |
| 13                  |                 | 31                 |                 |
| 14                  |                 | 32                 |                 |
| 15                  |                 | 33                 |                 |
| 16                  |                 | 34                 |                 |
| 17                  |                 | 35                 |                 |
| 18                  |                 | 36                 |                 |
| 19                  |                 |                    |                 |

| ENG. NO: 42375-4338/4341 |                 |                    |                 |
|--------------------------|-----------------|--------------------|-----------------|
| HEADER NUMBER:           |                 | 42312-0036         |                 |
| PIN NUMBER:              |                 | 42663-BGA154       |                 |
| PIN LENGTH: L            |                 | .585 / 14.86       |                 |
| MATING LENGTH: M         |                 | .398 / 10.11       |                 |
| GOLD POINT: G            |                 | N/A                |                 |
| PC TAIL LENGTH: P        |                 | .097 / 2.46        |                 |
| TIN: T                   |                 | OVERALL            |                 |
| CKTS:                    |                 | 2-36               |                 |
| KINKS:                   |                 | NO                 |                 |
| VOIDED CKTS:             |                 | NONE               |                 |
| PACKAGING:               |                 | BULK PK-40873-0041 |                 |
| CKTS                     | MATERIAL NUMBER | CKTS               | MATERIAL NUMBER |
| 2                        |                 | 20                 |                 |
| 3                        | 42375-4338      | 21                 |                 |
| 4                        |                 | 22                 |                 |
| 5                        |                 | 23                 |                 |
| 6                        | 42375-4341      | 24                 |                 |
| 7                        |                 | 25                 |                 |
| 8                        |                 | 26                 |                 |
| 9                        |                 | 27                 |                 |
| 10                       |                 | 28                 |                 |
| 11                       |                 | 29                 |                 |
| 12                       |                 | 30                 |                 |
| 13                       |                 | 31                 |                 |
| 14                       |                 | 32                 |                 |
| 15                       |                 | 33                 |                 |
| 16                       |                 | 34                 |                 |
| 17                       |                 | 35                 |                 |
| 18                       |                 | 36                 |                 |
| 19                       |                 |                    |                 |









DOCUMENT STATUS P1 RELEASE DATE 2021/12/20 12:18:33

| <b>SYMBOLS</b><br>= 0<br>= 0<br>= 0<br>= 0<br>= 0<br>= 0<br>= 0<br>= 0<br>= 0 | THIS DRAWING CONTAINS INFORMATION THAT IS PROPRIETARY TO MOLEX ELECTRONIC TECHNOLOGIES, LLC AND SHOULD NOT BE USED WITHOUT WRITTEN PERMISSION   |                        | CURRENT REV DESC: GOLD LENGTH SPEC CHANGED AS MIN 2.54- MAX 5.54 FOR A-42375-0037/0071 |  | <br><br>KK 100 HEADER ASSY<br>FLAT VERTICAL BREAKAWAY<br><br>PRODUCT CUSTOMER DRAWING |   |      |          |   |   |          |   |        |          |        |   |         |        |   |          |   |   |   |
|---|---|------------------------|--|--|---|---|------|----------|---|---|----------|---|--------|----------|--------|---|---------|--------|---|----------|---|---|---|
|   | DIMENSION UNITS: <b>MM/IN</b> SCALE: <b>1:1</b>   |                        | GENERAL TOLERANCES (UNLESS SPECIFIED)  |  |   | EC NO: 689596<br>DRWN: SHRUTJ      2021/09/14<br>CHK'D: SHRUTJ      2021/12/20<br>APPR: ISHWARG      2021/12/20 |      |          |   |   |          |   |        |          |        |   |         |        |   |          |   |   |   |
|   | <table border="1"> <tr><th></th><th>MM</th><th>INCH</th></tr> <tr><td>4 PLACES</td><td>±</td><td>±</td></tr> <tr><td>3 PLACES</td><td>±</td><td>± 0.01</td></tr> <tr><td>2 PLACES</td><td>± 0.25</td><td>±</td></tr> <tr><td>1 PLACE</td><td>± 0.38</td><td>±</td></tr> <tr><td>0 PLACES</td><td>±</td><td>±</td></tr> </table> |                        |  | MM   |   |   | INCH | 4 PLACES | ± | ± | 3 PLACES | ± | ± 0.01 | 2 PLACES | ± 0.25 | ± | 1 PLACE | ± 0.38 | ± | 0 PLACES | ± | ± | INITIAL REVISION:<br>DRWN: SCHAFFER      2003/02/11<br>APPR: MARGULIS      2004/02/27 |
|   |   | MM                     | INCH   |  |   |   |      |          |   |   |          |   |        |          |        |   |         |        |   |          |   |   |   |
|   | 4 PLACES  | ±                      | ±  |  |   |   |      |          |   |   |          |   |        |          |        |   |         |        |   |          |   |   |   |
|   | 3 PLACES  | ±                      | ± 0.01   |  |   |   |      |          |   |   |          |   |        |          |        |   |         |        |   |          |   |   |   |
|   | 2 PLACES  | ± 0.25                 | ±  |  |   |   |      |          |   |   |          |   |        |          |        |   |         |        |   |          |   |   |   |
|   | 1 PLACE   | ± 0.38                 | ±  |  |   |   |      |          |   |   |          |   |        |          |        |   |         |        |   |          |   |   |   |
|   | 0 PLACES  | ±                      | ±  |  |   |   |      |          |   |   |          |   |        |          |        |   |         |        |   |          |   |   |   |
|   | ANGULAR TOL ± 0.5°  |                        | DRAFT WHERE APPLICABLE MUST REMAIN WITHIN DIMENSIONS                                   |  |   | DOCUMENT NUMBER: <b>SD-42375-001</b> DOC TYPE: PSD      DOC PART: 001      REVISION: V                          |      |          |   |   |          |   |        |          |        |   |         |        |   |          |   |   |   |
| THIRD ANGLE PROJECTION  |   | DRAWING: <b>B-SIZE</b> | SERIES: <b>42375</b>   | MATERIAL NUMBER: SEE CHART      CUSTOMER: GENERAL MARKET      SHEET NUMBER: 34 OF 35 |   |   |      |          |   |   |          |   |        |          |        |   |         |        |   |          |   |   |   |

| ENG. NO: 42375-4413 |                 |                    |                 |
|---------------------|-----------------|--------------------|-----------------|
| HEADER NUMBER:      |                 | 42312-0036         |                 |
| PIN NUMBER:         |                 | 42663-ABB208       |                 |
| PIN LENGTH: L       |                 | .455 / 11.56       |                 |
| MATING LENGTH: M    |                 | .240 / 6.09        |                 |
| GOLD POINT: G       |                 | .100 / 2.54        |                 |
| PC TAIL LENGTH: P   |                 | .125 / 3.18        |                 |
| TIN: T              |                 | .100 / 2.54        |                 |
| CKTS:               |                 | 6-36               |                 |
| KINKS:              |                 | NO                 |                 |
| VOIDED CKTS:        |                 | 2, 4, 6            |                 |
| PACKAGING:          |                 | BULK PK-40873-0041 |                 |
| CKTS                | MATERIAL NUMBER | CKTS               | MATERIAL NUMBER |
| 2                   |                 | 20                 |                 |
| 3                   |                 | 21                 |                 |
| 4                   |                 | 22                 |                 |
| 5                   |                 | 23                 |                 |
| 6                   |                 | 24                 |                 |
| 7                   | 42375-4413      | 25                 |                 |
| 8                   |                 | 26                 |                 |
| 9                   |                 | 27                 |                 |
| 10                  |                 | 28                 |                 |
| 11                  |                 | 29                 |                 |
| 12                  |                 | 30                 |                 |
| 13                  |                 | 31                 |                 |
| 14                  |                 | 32                 |                 |
| 15                  |                 | 33                 |                 |
| 16                  |                 | 34                 |                 |
| 17                  |                 | 35                 |                 |
| 18                  |                 | 36                 |                 |
| 19                  |                 |                    |                 |

| ENG. NO: 42375-4445 |                 |                    |                 |
|---------------------|-----------------|--------------------|-----------------|
| HEADER NUMBER:      |                 | 42312-0036         |                 |
| PIN NUMBER:         |                 | 42663-0364         |                 |
| PLATING:            |                 | 228                |                 |
| PIN LENGTH: L       |                 | .590 / 14.99       |                 |
| MATING LENGTH: M    |                 | .380 / 9.65        |                 |
| GOLD POINT: G       |                 | .200 / 5.08        |                 |
| PC TAIL LENGTH: P   |                 | .120 / 3.05        |                 |
| TIN: T              |                 | .135 / 3.43        |                 |
| CKTS:               |                 | 2-36               |                 |
| KINKS:              |                 | NO                 |                 |
| VOIDED CKTS:        |                 | NONE               |                 |
| PACKAGING:          |                 | BULK PK-40873-0041 |                 |
| CKTS                | MATERIAL NUMBER | CKTS               | MATERIAL NUMBER |
| 2                   |                 | 20                 |                 |
| 3                   |                 | 21                 |                 |
| 4                   | 42375-4445      | 22                 |                 |
| 5                   |                 | 23                 |                 |
| 6                   |                 | 24                 |                 |
| 7                   |                 | 25                 |                 |
| 8                   |                 | 26                 |                 |
| 9                   |                 | 27                 |                 |
| 10                  |                 | 28                 |                 |
| 11                  |                 | 29                 |                 |
| 12                  |                 | 30                 |                 |
| 13                  |                 | 31                 |                 |
| 14                  |                 | 32                 |                 |
| 15                  |                 | 33                 |                 |
| 16                  |                 | 34                 |                 |
| 17                  |                 | 35                 |                 |
| 18                  |                 | 36                 |                 |
| 19                  |                 |                    |                 |

| ENG. NO: 42375-4549 |                 |                                       |                 |
|---------------------|-----------------|---------------------------------------|-----------------|
| HEADER NUMBER:      |                 | 42312-0036                            |                 |
| PIN NUMBER:         |                 | 42663-ABB208                          |                 |
| PLATING:            |                 | 208                                   |                 |
| PIN LENGTH: L       |                 | .455 / 11.56                          |                 |
| MATING LENGTH: M    |                 | .240 / 6.09                           |                 |
| GOLD POINT: G       |                 | .100 / 2.54                           |                 |
| PC TAIL LENGTH: P   |                 | .125 / 3.18                           |                 |
| TIN: T              |                 | .100 / 2.54                           |                 |
| CKTS:               |                 | 2-36                                  |                 |
| KINKS:              |                 | NO                                    |                 |
| VOIDED CKTS:        |                 | NONE                                  |                 |
| PACKAGING:          |                 | TAPE AND REEL W/O CAP<br>423751000-PK |                 |
| CKTS                | MATERIAL NUMBER | CKTS                                  | MATERIAL NUMBER |
| 2                   | 22-28-4029      | 20                                    |                 |
| 3                   |                 | 21                                    |                 |
| 4                   |                 | 22                                    |                 |
| 5                   |                 | 23                                    |                 |
| 6                   |                 | 24                                    |                 |
| 7                   |                 | 25                                    |                 |
| 8                   |                 | 26                                    |                 |
| 9                   |                 | 27                                    |                 |
| 10                  |                 | 28                                    |                 |
| 11                  |                 | 29                                    |                 |
| 12                  |                 | 30                                    |                 |
| 13                  |                 | 31                                    |                 |
| 14                  |                 | 32                                    |                 |
| 15                  |                 | 33                                    |                 |
| 16                  |                 | 34                                    |                 |
| 17                  |                 | 35                                    |                 |
| 18                  |                 | 36                                    |                 |
| 19                  |                 |                                       |                 |

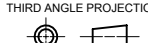
|  |   |  |  |   |
|--|---|--|--|---|
| <b>SYMBOLS</b><br> = 0<br> = 0<br> = 0<br> = 0<br> = 0<br> = 0<br> = 0<br> = 0 | THIS DRAWING CONTAINS INFORMATION THAT IS PROPRIETARY TO MOLEX ELECTRONIC TECHNOLOGIES, LLC AND SHOULD NOT BE USED WITHOUT WRITTEN PERMISSION<br>DIMENSION UNITS: <b>MM/IN</b><br>SCALE: <b>1:1</b> | CURRENT REV DESC: GOLD LENGTH SPEC<br>CHANGED AS MIN 2.54- MAX 5.54 FOR<br>A-42375-0037/0071<br>EC NO: 689596<br>DRWN: SHRUTJ 2021/09/14<br>CHK'D: SHRUTJ 2021/12/20<br>APPR: ISHWARG 2021/12/20 | <br>KK 100 HEADER ASSY<br>FLAT VERTICAL BREAKAWAY<br>PRODUCT CUSTOMER DRAWING |   |
|  | GENERAL TOLERANCES<br>(UNLESS SPECIFIED)  | INITIAL REVISION:<br>DRWN: SCHAFFER 2003/02/11<br>APPR: MARGULIS 2004/02/27  |  | DOCUMENT NUMBER: <b>SD-42375-001</b><br>DOC TYPE: PSD<br>DOC PART: 001<br>REVISION: V                           |
|  | 4 PLACES ±<br>3 PLACES ± 0.01<br>2 PLACES ± 0.25<br>1 PLACE ± 0.38<br>0 PLACES ±  | ANGULAR TOL ± 0.5°<br>DRAFT WHERE APPLICABLE<br>MUST REMAIN<br>WITHIN DIMENSIONS   |  | THIRD ANGLE PROJECTION<br> |
|  | DRAWING: B-SIZE<br>SERIES: 42375<br>MATERIAL NUMBER: SEE CHART<br>CUSTOMER: GENERAL MARKET<br>SHEET NUMBER: 35 OF 35  |  |  |   |

ENG. NO: A-42375-0002/0036

|                   |                    |
|-------------------|--------------------|
| HEADER NUMBER:    | 42312-0036         |
| PIN NUMBER:       | 42663-ABA154       |
| PIN LENGTH: L     | .455 / 11.56       |
| MATING LENGTH: M  | .240 / 6.09        |
| GOLD POINT: G     | N/A                |
| PC TAIL LENGTH: P | .125 / 3.18        |
| TIN: T            | OVERALL            |
| CKTS:             | 2-36               |
| KINKS:            | NO                 |
| VOIDED CKTS:      | NONE               |
| PACKAGING:        | BULK PK-40873-0041 |

| CKTS | MATERIAL NUMBER | ENG NUMBER   | CKTS | MATERIAL NUMBER | ENG NUMBER   |
|------|-----------------|--------------|------|-----------------|--------------|
| 02   | 22-28-4020      | A-42375-0002 | 20   | 22-28-4200      | A-42375-0020 |
| 03   | 22-28-4030      | A-42375-0003 | 21   | 22-28-4210      | A-42375-0021 |
| 04   | 22-28-4040      | A-42375-0004 | 22   | 22-28-4220      | A-42375-0022 |
| 05   | 22-28-4050      | A-42375-0005 | 23   | 22-28-4230      | A-42375-0023 |
| 06   | 22-28-4060      | A-42375-0006 | 24   | 22-28-4240      | A-42375-0024 |
| 07   | 22-28-4070      | A-42375-0007 | 25   | 22-28-4250      | A-42375-0025 |
| 08   | 22-28-4080      | A-42375-0008 | 26   | 22-28-4260      | A-42375-0026 |
| 09   | 22-28-4090      | A-42375-0009 | 27   | 22-28-4270      | A-42375-0027 |
| 10   | 22-28-4100      | A-42375-0010 | 28   | 22-28-4280      | A-42375-0028 |
| 11   | 22-28-4110      | A-42375-0011 | 29   | 22-28-4290      | A-42375-0029 |
| 12   | 22-28-4120      | A-42375-0012 | 30   | 22-28-4300      | A-42375-0030 |
| 13   | 22-28-4130      | A-42375-0013 | 31   | 22-28-4310      | A-42375-0031 |
| 14   | 22-28-4140      | A-42375-0014 | 32   | 22-28-4320      | A-42375-0032 |
| 15   | 22-28-4150      | A-42375-0015 | 33   | 22-28-4330      | A-42375-0033 |
| 16   | 22-28-4160      | A-42375-0016 | 34   | 22-28-4340      | A-42375-0034 |
| 17   | 22-28-4170      | A-42375-0017 | 35   | 22-28-4350      | A-42375-0035 |
| 18   | 22-28-4180      | A-42375-0018 | 36   | 22-28-4360      | A-42375-0036 |
| 19   | 22-28-4190      | A-42375-0019 |      |                 |              |

ENG. NO: A-42375-0037/0071

|                   |                                |
|-------------------|--------------------------------|
| HEADER NUMBER:    | 42312-0036                     |
| PIN NUMBER:       | 42663-ABB208                   |
| PIN LENGTH: L     | .455 / 11.56                   |
| MATING LENGTH: M  | .240 / 6.09                    |
| GOLD POINT: G     | .100 / 2.54 Min-0.218/5.54 Max |
| PC TAIL LENGTH: P | .125 / 3.18                    |
| TIN: T            | .100 / 2.54                    |
| CKTS:             | 2-36                           |
| KINKS:            | NO                             |
| VOIDED CKTS:      | NONE                           |
| PACKAGING:        | BULK PK-40873-0041             |

| CKTS | MATERIAL NUMBER | ENG NUMBER   | CKTS | MATERIAL NUMBER | ENG NUMBER   |
|------|-----------------|--------------|------|-----------------|--------------|
| 02   | 22-28-4023      | A-42375-0037 | 20   | 22-28-4203      | A-42375-0055 |
| 03   | 22-28-4033      | A-42375-0038 | 21   | 22-28-4213      | A-42375-0056 |
| 04   | 22-28-4043      | A-42375-0039 | 22   | 22-28-4223      | A-42375-0057 |
| 05   | 22-28-4053      | A-42375-0040 | 23   | 22-28-4233      | A-42375-0058 |
| 06   | 22-28-4063      | A-42375-0041 | 24   | 22-28-4243      | A-42375-0059 |
| 07   | 22-28-4073      | A-42375-0042 | 25   | 22-28-4253      | A-42375-0060 |
| 08   | 22-28-4083      | A-42375-0043 | 26   | 22-28-4263      | A-42375-0061 |
| 09   | 22-28-4093      | A-42375-0044 | 27   | 22-28-4273      | A-42375-0062 |
| 10   | 22-28-4103      | A-42375-0045 | 28   | 22-28-4283      | A-42375-0063 |
| 11   | 22-28-4113      | A-42375-0046 | 29   | 22-28-4293      | A-42375-0064 |
| 12   | 22-28-4123      | A-42375-0047 | 30   | 22-28-4303      | A-42375-0065 |
| 13   | 22-28-4133      | A-42375-0048 | 31   | 22-28-4313      | A-42375-0066 |
| 14   | 22-28-4143      | A-42375-0049 | 32   | 22-28-4323      | A-42375-0067 |
| 15   | 22-28-4153      | A-42375-0050 | 33   | 22-28-4333      | A-42375-0068 |
| 16   | 22-28-4163      | A-42375-0051 | 34   | 22-28-4343      | A-42375-0069 |
| 17   | 22-28-4173      | A-42375-0052 | 35   | 22-28-4353      | A-42375-0070 |
| 18   | 22-28-4183      | A-42375-0053 | 36   | 22-28-4363      | A-42375-0071 |
| 19   | 22-28-4193      | A-42375-0054 |      |                 |              |

|                      |      |                             |                |   |              |
|----------------------|------|-----------------------------|----------------|---|--------------|
| <b>U</b>             | REV: | ECR/ECN INFORMATION:        | TITLE:         | <b>KK 100 HEADER ASSY<br/>FLAT VERTICAL<br/>BREAKAWAY</b> | SHEET No.    |
|                      |      | EC No.: <b>UCP2017-2793</b> |                |   | <b>- 2 -</b> |
|                      |      | DATE: <b>12/20/2021</b>     |                |   |              |
| DOCUMENT NUMBER:     |      | CREATED / REVISED BY:       | CHECKED BY:    | APPROVED BY:  |              |
| <b>SD- 42375-001</b> |      | <b>SS06</b>                 | <b>ISHWARG</b> | <b>ISHWARG</b>  |              |

ENG. NO: A-42375-0072/0106

|                   |                    |
|-------------------|--------------------|
| HEADER NUMBER:    | 42312-0036         |
| PIN NUMBER:       | 42663-ABB228       |
| PIN LENGTH: L     | .455 / 11.56       |
| MATING LENGTH: M  | .240 / 6.09        |
| GOLD POINT: G     | .100 / 2.54        |
| PC TAIL LENGTH: P | .125 / 3.18        |
| TIN: T            | .100 / 2.54        |
| CKTS:             | 2-36               |
| KINKS:            | NO                 |
| VOIDED CKTS:      | NONE               |
| PACKAGING:        | BULK PK-40873-0041 |

| CKTS | MATERIAL NUMBER | ENG NUMBER   | CKTS | MATERIAL NUMBER | ENG NUMBER   |
|------|-----------------|--------------|------|-----------------|--------------|
| 02   | 22-28-4026      | A-42375-0072 | 20   | 22-28-4206      | A-42375-0090 |
| 03   | 22-28-4036      | A-42375-0073 | 21   | 22-28-4216      | A-42375-0091 |
| 04   | 22-28-4046      | A-42375-0074 | 22   | 22-28-4226      | A-42375-0092 |
| 05   | 22-28-4056      | A-42375-0075 | 23   | 22-28-4236      | A-42375-0093 |
| 06   | 22-28-4066      | A-42375-0076 | 24   | 22-28-4246      | A-42375-0094 |
| 07   | 22-28-4076      | A-42375-0077 | 25   | 22-28-4256      | A-42375-0095 |
| 08   | 22-28-4086      | A-42375-0078 | 26   | 22-28-4266      | A-42375-0096 |
| 09   | 22-28-4096      | A-42375-0079 | 27   | 22-28-4276      | A-42375-0097 |
| 10   | 22-28-4106      | A-42375-0080 | 28   | 22-28-4286      | A-42375-0098 |
| 11   | 22-28-4116      | A-42375-0081 | 29   | 22-28-4296      | A-42375-0099 |
| 12   | 22-28-4126      | A-42375-0082 | 30   | 22-28-4306      | A-42375-0100 |
| 13   | 22-28-4136      | A-42375-0083 | 31   | 22-28-4316      | A-42375-0101 |
| 14   | 22-28-4146      | A-42375-0084 | 32   | 22-28-4326      | A-42375-0102 |
| 15   | 22-28-4156      | A-42375-0085 | 33   | 22-28-4336      | A-42375-0103 |
| 16   | 22-28-4166      | A-42375-0086 | 34   | 22-28-4346      | A-42375-0104 |
| 17   | 22-28-4176      | A-42375-0087 | 35   | 22-28-4356      | A-42375-0105 |
| 18   | 22-28-4186      | A-42375-0088 | 36   | 22-28-4366      | A-42375-0106 |
| 19   | 22-28-4196      | A-42375-0089 |      |                 |              |

ENG. NO: A-42375-0107/0141

|                   |                    |
|-------------------|--------------------|
| HEADER NUMBER:    | 42312-0036         |
| PIN NUMBER:       | 42663-ATA154       |
| PIN LENGTH: L     | .530 / 13.46       |
| MATING LENGTH: M  | .320 / 8.13        |
| GOLD POINT: G     | N/A                |
| PC TAIL LENGTH: P | .120 / 3.05        |
| TIN: T            | OVERALL            |
| CKTS:             | 2-36               |
| KINKS:            | NO                 |
| VOIDED CKTS:      | NONE               |
| PACKAGING:        | BULK PK-40873-0041 |

| CKTS | MATERIAL NUMBER | ENG NUMBER   | CKTS | MATERIAL NUMBER | ENG NUMBER   |
|------|-----------------|--------------|------|-----------------|--------------|
| 02   | 22-28-4021      | A-42375-0107 | 20   | 22-28-4201      | A-42375-0125 |
| 03   | 22-28-4031      | A-42375-0108 | 21   | 22-28-4211      | A-42375-0126 |
| 04   | 22-28-4041      | A-42375-0109 | 22   | 22-28-4221      | A-42375-0127 |
| 05   | 22-28-4051      | A-42375-0110 | 23   | 22-28-4231      | A-42375-0128 |
| 06   | 22-28-4061      | A-42375-0111 | 24   | 22-28-4241      | A-42375-0129 |
| 07   | 22-28-4071      | A-42375-0112 | 25   | 22-28-4251      | A-42375-0130 |
| 08   | 22-28-4081      | A-42375-0113 | 26   | 22-28-4261      | A-42375-0131 |
| 09   | 22-28-4091      | A-42375-0114 | 27   | 22-28-4271      | A-42375-0132 |
| 10   | 22-28-4101      | A-42375-0115 | 28   | 22-28-4281      | A-42375-0133 |
| 11   | 22-28-4111      | A-42375-0116 | 29   | 22-28-4291      | A-42375-0134 |
| 12   | 22-28-4121      | A-42375-0117 | 30   | 22-28-4301      | A-42375-0135 |
| 13   | 22-28-4131      | A-42375-0118 | 31   | 22-28-4311      | A-42375-0136 |
| 14   | 22-28-4141      | A-42375-0119 | 32   | 22-28-4321      | A-42375-0137 |
| 15   | 22-28-4151      | A-42375-0120 | 33   | 22-28-4331      | A-42375-0138 |
| 16   | 22-28-4161      | A-42375-0121 | 34   | 22-28-4341      | A-42375-0139 |
| 17   | 22-28-4171      | A-42375-0122 | 35   | 22-28-4351      | A-42375-0140 |
| 18   | 22-28-4181      | A-42375-0123 | 36   | 22-28-4361      | A-42375-0141 |
| 19   | 22-28-4191      | A-42375-0124 |      |                 |              |

|  |  |   |                                |
|--|--|---|--------------------------------|
| REV:<br><b>U</b>                         | ECR/ECN INFORMATION:<br>EC No.: <b>UCP2017-2793</b><br>DATE: <b>12/20/2021</b> | TITLE:<br><b>KK 100 HEADER ASSY<br/>FLAT VERTICAL<br/>BREAKAWAY</b> | SHEET No.<br><b>- 3 -</b>      |
| DOCUMENT NUMBER:<br><b>SD- 42375-001</b> | CREATED / REVISED BY:<br><b>SS06</b>   | CHECKED BY:<br><b>ISHWARG</b>                                       | APPROVED BY:<br><b>ISHWARG</b> |

ENG. NO: A-42375-0142/0176

|                   |                    |
|-------------------|--------------------|
| HEADER NUMBER:    | 42312-0036         |
| PIN NUMBER:       | 42663-ATB208       |
| PIN LENGTH: L     | .530 / 13.46       |
| MATING LENGTH: M  | .320 / 8.13        |
| GOLD POINT: G     | .140 / 3.56        |
| PC TAIL LENGTH: P | .120 / 3.05        |
| TIN: T            | .135 / 3.43        |
| CKTS:             | 2-36               |
| KINKS:            | NO                 |
| VOIDED CKTS:      | NONE               |
| PACKAGING:        | BULK PK-40873-0041 |

| CKTS | MATERIAL NUMBER | ENG NUMBER   | CKTS | MATERIAL NUMBER | ENG NUMBER   |
|------|-----------------|--------------|------|-----------------|--------------|
| 02   | 22-28-4024      | A-42375-0142 | 20   | 22-28-4204      | A-42375-0160 |
| 03   | 22-28-4034      | A-42375-0143 | 21   | 22-28-4214      | A-42375-0161 |
| 04   | 22-28-4044      | A-42375-0144 | 22   | 22-28-4224      | A-42375-0162 |
| 05   | 22-28-4054      | A-42375-0145 | 23   | 22-28-4234      | A-42375-0163 |
| 06   | 22-28-4064      | A-42375-0146 | 24   | 22-28-4244      | A-42375-0164 |
| 07   | 22-28-4074      | A-42375-0147 | 25   | 22-28-4254      | A-42375-0165 |
| 08   | 22-28-4084      | A-42375-0148 | 26   | 22-28-4264      | A-42375-0166 |
| 09   | 22-28-4094      | A-42375-0149 | 27   | 22-28-4274      | A-42375-0167 |
| 10   | 22-28-4104      | A-42375-0150 | 28   | 22-28-4284      | A-42375-0168 |
| 11   | 22-28-4114      | A-42375-0151 | 29   | 22-28-4294      | A-42375-0169 |
| 12   | 22-28-4124      | A-42375-0152 | 30   | 22-28-4304      | A-42375-0170 |
| 13   | 22-28-4134      | A-42375-0153 | 31   | 22-28-4314      | A-42375-0171 |
| 14   | 22-28-4144      | A-42375-0154 | 32   | 22-28-4324      | A-42375-0172 |
| 15   | 22-28-4154      | A-42375-0155 | 33   | 22-28-4334      | A-42375-0173 |
| 16   | 22-28-4164      | A-42375-0156 | 34   | 22-28-4344      | A-42375-0174 |
| 17   | 22-28-4174      | A-42375-0157 | 35   | 22-28-4354      | A-42375-0175 |
| 18   | 22-28-4184      | A-42375-0158 | 36   | 22-28-4364      | A-42375-0176 |
| 19   | 22-28-4194      | A-42375-0159 |      |                 |              |

ENG. NO: A-42375-0177/0211

|                   |                    |
|-------------------|--------------------|
| HEADER NUMBER:    | 42312-0036         |
| PIN NUMBER:       | 42663-ATB228       |
| PIN LENGTH: L     | .530 / 13.46       |
| MATING LENGTH: M  | .320 / 8.13        |
| GOLD POINT: G     | .140 / 3.56        |
| PC TAIL LENGTH: P | .120 / 3.05        |
| TIN: T            | .135 / 3.43        |
| CKTS:             | 2-36               |
| KINKS:            | NO                 |
| VOIDED CKTS:      | NONE               |
| PACKAGING:        | BULK PK-40873-0041 |

| CKTS | MATERIAL NUMBER | ENG NUMBER   | CKTS | MATERIAL NUMBER | ENG NUMBER   |
|------|-----------------|--------------|------|-----------------|--------------|
| 02   | 22-28-4027      | A-42375-0177 | 20   | 22-28-4207      | A-42375-0195 |
| 03   | 22-28-4037      | A-42375-0178 | 21   | 22-28-4217      | A-42375-0196 |
| 04   | 22-28-4047      | A-42375-0179 | 22   | 22-28-4227      | A-42375-0197 |
| 05   | 22-28-4057      | A-42375-0180 | 23   | 22-28-4237      | A-42375-0198 |
| 06   | 22-28-4067      | A-42375-0181 | 24   | 22-28-4247      | A-42375-0199 |
| 07   | 22-28-4077      | A-42375-0182 | 25   | 22-28-4257      | A-42375-0200 |
| 08   | 22-28-4087      | A-42375-0183 | 26   | 22-28-4267      | A-42375-0201 |
| 09   | 22-28-4097      | A-42375-0184 | 27   | 22-28-4277      | A-42375-0202 |
| 10   | 22-28-4107      | A-42375-0185 | 28   | 22-28-4287      | A-42375-0203 |
| 11   | 22-28-4117      | A-42375-0186 | 29   | 22-28-4297      | A-42375-0204 |
| 12   | 22-28-4127      | A-42375-0187 | 30   | 22-28-4307      | A-42375-0205 |
| 13   | 22-28-4137      | A-42375-0188 | 31   | 22-28-4317      | A-42375-0206 |
| 14   | 22-28-4147      | A-42375-0189 | 32   | 22-28-4327      | A-42375-0207 |
| 15   | 22-28-4157      | A-42375-0190 | 33   | 22-28-4337      | A-42375-0208 |
| 16   | 22-28-4167      | A-42375-0191 | 34   | 22-28-4347      | A-42375-0209 |
| 17   | 22-28-4177      | A-42375-0192 | 35   | 22-28-4357      | A-42375-0210 |
| 18   | 22-28-4187      | A-42375-0193 | 36   | 22-28-4367      | A-42375-0211 |
| 19   | 22-28-4197      | A-42375-0194 |      |                 |              |

REV:

**U**ECR/ECN INFORMATION:EC No.: **UCP2017-2793**DATE: **12/20/2021**TITLE:**KK 100 HEADER ASSY  
FLAT VERTICAL  
BREAKAWAY**SHEET No.**- 4 -**DOCUMENT NUMBER:**SD- 42375-001**CREATED / REVISED BY:**SS06**CHECKED BY:**ISHWARG**APPROVED BY:**ISHWARG**

ENG. NO: A-42375-0212/0246

|                   |                    |
|-------------------|--------------------|
| HEADER NUMBER:    | 42312-0036         |
| PIN NUMBER:       | 42663-AMA154       |
| PIN LENGTH: L     | .505 / 12.83       |
| MATING LENGTH: M  | .295 / 7.49        |
| GOLD POINT: G     | N/A                |
| PC TAIL LENGTH: P | .120 / 3.05        |
| TIN: T            | OVERALL            |
| CKTS:             | 2-36               |
| KINKS:            | NO                 |
| VOIDED CKTS:      | NONE               |
| PACKAGING:        | BULK PK-40873-0041 |

| CKTS | MATERIAL NUMBER | ENG NUMBER   | CKTS | MATERIAL NUMBER | ENG NUMBER   |
|------|-----------------|--------------|------|-----------------|--------------|
| 02   | 22-28-4022      | A-42375-0212 | 20   | 22-28-4202      | A-42375-0230 |
| 03   | 22-28-4032      | A-42375-0213 | 21   | 22-28-4212      | A-42375-0231 |
| 04   | 22-28-4042      | A-42375-0214 | 22   | 22-28-4222      | A-42375-0232 |
| 05   | 22-28-4052      | A-42375-0215 | 23   | 22-28-4232      | A-42375-0233 |
| 06   | 22-28-4062      | A-42375-0216 | 24   | 22-28-4242      | A-42375-0234 |
| 07   | 22-28-4072      | A-42375-0217 | 25   | 22-28-4252      | A-42375-0235 |
| 08   | 22-28-4082      | A-42375-0218 | 26   | 22-28-4262      | A-42375-0236 |
| 09   | 22-28-4092      | A-42375-0219 | 27   | 22-28-4272      | A-42375-0237 |
| 10   | 22-28-4102      | A-42375-0220 | 28   | 22-28-4282      | A-42375-0238 |
| 11   | 22-28-4112      | A-42375-0221 | 29   | 22-28-4292      | A-42375-0239 |
| 12   | 22-28-4122      | A-42375-0222 | 30   | 22-28-4302      | A-42375-0240 |
| 13   | 22-28-4132      | A-42375-0223 | 31   | 22-28-4312      | A-42375-0241 |
| 14   | 22-28-4142      | A-42375-0224 | 32   | 22-28-4322      | A-42375-0242 |
| 15   | 22-28-4152      | A-42375-0225 | 33   | 22-28-4332      | A-42375-0243 |
| 16   | 22-28-4162      | A-42375-0226 | 34   | 22-28-4342      | A-42375-0244 |
| 17   | 22-28-4172      | A-42375-0227 | 35   | 22-28-4352      | A-42375-0245 |
| 18   | 22-28-4182      | A-42375-0228 | 36   | 22-28-4362      | A-42375-0246 |
| 19   | 22-28-4192      | A-42375-0229 |      |                 |              |

ENG. NO: A-42375-0247/0281

|                   |                    |
|-------------------|--------------------|
| HEADER NUMBER:    | 42312-0036         |
| PIN NUMBER:       | 42663-AMB208       |
| PIN LENGTH: L     | .505 / 12.83       |
| MATING LENGTH: M  | .295 / 7.49        |
| GOLD POINT: G     | .140 / 3.56        |
| PC TAIL LENGTH: P | .120 / 3.05        |
| TIN: T            | .135 / 3.43        |
| CKTS:             | 2-36               |
| KINKS:            | NO                 |
| VOIDED CKTS:      | NONE               |
| PACKAGING:        | BULK PK-40873-0041 |

| CKTS | MATERIAL NUMBER | ENG NUMBER   | CKTS | MATERIAL NUMBER | ENG NUMBER   |
|------|-----------------|--------------|------|-----------------|--------------|
| 02   | 22-28-4025      | A-42375-0247 | 20   | 22-28-4205      | A-42375-0265 |
| 03   | 22-28-4035      | A-42375-0248 | 21   | 22-28-4215      | A-42375-0266 |
| 04   | 22-28-4045      | A-42375-0249 | 22   | 22-28-4225      | A-42375-0267 |
| 05   | 22-28-4055      | A-42375-0250 | 23   | 22-28-4235      | A-42375-0268 |
| 06   | 22-28-4065      | A-42375-0251 | 24   | 22-28-4245      | A-42375-0269 |
| 07   | 22-28-4075      | A-42375-0252 | 25   | 22-28-4255      | A-42375-0270 |
| 08   | 22-28-4085      | A-42375-0253 | 26   | 22-28-4265      | A-42375-0271 |
| 09   | 22-28-4095      | A-42375-0254 | 27   | 22-28-4275      | A-42375-0272 |
| 10   | 22-28-4105      | A-42375-0255 | 28   | 22-28-4285      | A-42375-0273 |
| 11   | 22-28-4115      | A-42375-0256 | 29   | 22-28-4295      | A-42375-0274 |
| 12   | 22-28-4125      | A-42375-0257 | 30   | 22-28-4305      | A-42375-0275 |
| 13   | 22-28-4135      | A-42375-0258 | 31   | 22-28-4315      | A-42375-0276 |
| 14   | 22-28-4145      | A-42375-0259 | 32   | 22-28-4325      | A-42375-0277 |
| 15   | 22-28-4155      | A-42375-0260 | 33   | 22-28-4335      | A-42375-0278 |
| 16   | 22-28-4165      | A-42375-0261 | 34   | 22-28-4345      | A-42375-0279 |
| 17   | 22-28-4175      | A-42375-0262 | 35   | 22-28-4355      | A-42375-0280 |
| 18   | 22-28-4185      | A-42375-0263 | 36   | 22-28-4365      | A-42375-0281 |
| 19   | 22-28-4195      | A-42375-0264 |      |                 |              |

|  |  |   |                               |
|--|--|---|-------------------------------|
| REV:<br><b>U</b>                         | ECR/ECN INFORMATION:<br>EC No.: <b>UCP2017-2793</b><br>DATE: <b>12/20/2021</b> | TITLE:<br><b>KK 100 HEADER ASSY<br/>FLAT VERTICAL<br/>BREAKAWAY</b> | SHEET No.<br><b>- 5 -</b>     |
| DOCUMENT NUMBER:<br><b>SD- 42375-001</b> |  | CREATED / REVISED BY:<br><b>SS06</b>                                | CHECKED BY:<br><b>ISHWARG</b> |
|  |  | APPROVED BY:<br><b>ISHWARG</b>                                      |                               |

|                            |  |                    |  |  |  |
|----------------------------|--|--------------------|--|--|--|
| ENG. NO: A-42375-0282/0316 |  |                    |  |  |  |
| HEADER NUMBER:             |  | 42312-0036         |  |  |  |
| PIN NUMBER:                |  | 42663-AMB228       |  |  |  |
| PIN LENGTH: L              |  | .505 / 12.83       |  |  |  |
| MATING LENGTH: M           |  | .295 / 7.49        |  |  |  |
| GOLD POINT: G              |  | .140 / 3.56        |  |  |  |
| PC TAIL LENGTH: P          |  | .120 / 3.05        |  |  |  |
| TIN: T                     |  | .135 / 3.43        |  |  |  |
| CKTS:                      |  | 2-36               |  |  |  |
| KINKS:                     |  | NO                 |  |  |  |
| VOIDED CKTS:               |  | NONE               |  |  |  |
| PACKAGING:                 |  | BULK PK-40873-0041 |  |  |  |

| CKTS | MATERIAL NUMBER | ENG NUMBER   | CKTS | MATERIAL NUMBER | ENG NUMBER   |
|------|-----------------|--------------|------|-----------------|--------------|
| 02   | 22-28-4028      | A-42375-0282 | 20   | 22-28-4208      | A-42375-0300 |
| 03   | 22-28-4038      | A-42375-0283 | 21   | 22-28-4218      | A-42375-0301 |
| 04   | 22-28-4048      | A-42375-0284 | 22   | 22-28-4228      | A-42375-0302 |
| 05   | 22-28-4058      | A-42375-0285 | 23   | 22-28-4238      | A-42375-0303 |
| 06   | 22-28-4068      | A-42375-0286 | 24   | 22-28-4248      | A-42375-0304 |
| 07   | 22-28-4078      | A-42375-0287 | 25   | 22-28-4258      | A-42375-0305 |
| 08   | 22-28-4088      | A-42375-0288 | 26   | 22-28-4268      | A-42375-0306 |
| 09   | 22-28-4098      | A-42375-0289 | 27   | 22-28-4278      | A-42375-0307 |
| 10   | 22-28-4108      | A-42375-0290 | 28   | 22-28-4288      | A-42375-0308 |
| 11   | 22-28-4118      | A-42375-0291 | 29   | 22-28-4298      | A-42375-0309 |
| 12   | 22-28-4128      | A-42375-0192 | 30   | 22-28-4308      | A-42375-0310 |
| 13   | 22-28-4138      | A-42375-0293 | 31   | 22-28-4318      | A-42375-0311 |
| 14   | 22-28-4148      | A-42375-0294 | 32   | 22-28-4328      | A-42375-0312 |
| 15   | 22-28-4158      | A-42375-0295 | 33   | 22-28-4338      | A-42375-0313 |
| 16   | 22-28-4168      | A-42375-0296 | 34   | 22-28-4348      | A-42375-0314 |
| 17   | 22-28-4178      | A-42375-0297 | 35   | 22-28-4358      | A-42375-0315 |
| 18   | 22-28-4188      | A-42375-0298 | 36   | 22-28-4368      | A-42375-0316 |
| 19   | 22-28-4198      | A-42375-0299 |      |                 |              |

|                            |  |                    |  |  |  |
|----------------------------|--|--------------------|--|--|--|
| ENG. NO: A-42375-0317/0351 |  |                    |  |  |  |
| HEADER NUMBER:             |  | 42312-0036         |  |  |  |
| PIN NUMBER:                |  | 42663-ADA154       |  |  |  |
| PIN LENGTH: L              |  | .465 / 11.81       |  |  |  |
| MATING LENGTH: M           |  | .240 / 6.09        |  |  |  |
| GOLD POINT: G              |  | N/A                |  |  |  |
| PC TAIL LENGTH: P          |  | .135 / 3.43        |  |  |  |
| TIN: T                     |  | OVERALL            |  |  |  |
| CKTS:                      |  | 2-36               |  |  |  |
| KINKS:                     |  | SMES-42003         |  |  |  |
| VOIDED CKTS:               |  | NONE               |  |  |  |
| PACKAGING:                 |  | BULK PK-40873-0041 |  |  |  |

| CKTS | MATERIAL NUMBER | ENG NUMBER   | CKTS | MATERIAL NUMBER | ENG NUMBER   |
|------|-----------------|--------------|------|-----------------|--------------|
| 02   | 22-28-5020      | A-42375-0317 | 20   | 22-28-5200      | A-42375-0335 |
| 03   | 22-28-5030      | A-42375-0318 | 21   | 22-28-5210      | A-42375-0336 |
| 04   | 22-28-5040      | A-42375-0319 | 22   | 22-28-5220      | A-42375-0337 |
| 05   | 22-28-5050      | A-42375-0320 | 23   | 22-28-5230      | A-42375-0338 |
| 06   | 22-28-5060      | A-42375-0321 | 24   | 22-28-5240      | A-42375-0339 |
| 07   | 22-28-5070      | A-42375-0322 | 25   | 22-28-5250      | A-42375-0340 |
| 08   | 22-28-5080      | A-42375-0323 | 26   | 22-28-5260      | A-42375-0341 |
| 09   | 22-28-5090      | A-42375-0324 | 27   | 22-28-5270      | A-42375-0342 |
| 10   | 22-28-5100      | A-42375-0325 | 28   | 22-28-5280      | A-42375-0343 |
| 11   | 22-28-5110      | A-42375-0326 | 29   | 22-28-5290      | A-42375-0344 |
| 12   | 22-28-5120      | A-42375-0327 | 30   | 22-28-5300      | A-42375-0345 |
| 13   | 22-28-5130      | A-42375-0328 | 31   | 22-28-5310      | A-42375-0346 |
| 14   | 22-28-5140      | A-42375-0329 | 32   | 22-28-5320      | A-42375-0347 |
| 15   | 22-28-5150      | A-42375-0330 | 33   | 22-28-5330      | A-42375-0348 |
| 16   | 22-28-5160      | A-42375-0331 | 34   | 22-28-5340      | A-42375-0349 |
| 17   | 22-28-5170      | A-42375-0332 | 35   | 22-28-5350      | A-42375-0350 |
| 18   | 22-28-5180      | A-42375-0333 | 36   | 22-28-5360      | A-42375-0351 |
| 19   | 22-28-5190      | A-42375-0334 |      |                 |              |

|   |      |   |   |                                       |
|---|------|---|---|---------------------------------------|
| <b>U</b>  | REV: | <u>ECR/ECN INFORMATION:</u>                 | <u>TITLE:</u>   | <u>SHEET No.</u>                      |
|   |      | EC No.: <b>UCP2017-2793</b>                 | <b>KK 100 HEADER ASSY<br/>FLAT VERTICAL<br/>BREAKAWAY</b> | <b>- 6 -</b>                          |
|   |      | DATE: <b>12/20/2021</b>                     |   |                                       |
| <u>DOCUMENT NUMBER:</u><br><b>SD- 42375-001</b> |      | <u>CREATED / REVISED BY:</u><br><b>SS06</b> | <u>CHECKED BY:</u><br><b>ISHWARG</b>                      | <u>APPROVED BY:</u><br><b>ISHWARG</b> |



| ENG. NO: A-42375-0352/0386 |                 |                    |      |                 |              |
|----------------------------|-----------------|--------------------|------|-----------------|--------------|
| HEADER NUMBER:             |                 | 42312-0036         |      |                 |              |
| PIN NUMBER:                |                 | 42663-ADB208       |      |                 |              |
| PIN LENGTH: L              |                 | .465 / 11.81       |      |                 |              |
| MATING LENGTH: M           |                 | .240 / 6.09        |      |                 |              |
| GOLD POINT: G              |                 | .100 / 2.54        |      |                 |              |
| PC TAIL LENGTH: P          |                 | .135 / 3.43        |      |                 |              |
| TIN: T                     |                 | .100 / 2.54        |      |                 |              |
| CKTS:                      |                 | 2-36               |      |                 |              |
| KINKS:                     |                 | SMES-42003         |      |                 |              |
| VOIDED CKTS:               |                 | NONE               |      |                 |              |
| PACKAGING:                 |                 | BULK PK-40873-0041 |      |                 |              |
| CKTS                       | MATERIAL NUMBER | ENG NUMBER         | CKTS | MATERIAL NUMBER | ENG NUMBER   |
| 02                         | 22-28-5023      | A-42375-0352       | 20   | 22-28-5203      | A-42375-0370 |
| 03                         | 22-28-5033      | A-42375-0353       | 21   | 22-28-5213      | A-42375-0371 |
| 04                         | 22-28-5043      | A-42375-0354       | 22   | 22-28-5223      | A-42375-0372 |
| 05                         | 22-28-5053      | A-42375-0355       | 23   | 22-28-5233      | A-42375-0373 |
| 06                         | 22-28-5063      | A-42375-0356       | 24   | 22-28-5243      | A-42375-0374 |
| 07                         | 22-28-5073      | A-42375-0357       | 25   | 22-28-5253      | A-42375-0375 |
| 08                         | 22-28-5083      | A-42375-0358       | 26   | 22-28-5263      | A-42375-0376 |
| 09                         | 22-28-5093      | A-42375-0359       | 27   | 22-28-5273      | A-42375-0377 |
| 10                         | 22-28-5103      | A-42375-0360       | 28   | 22-28-5283      | A-42375-0378 |
| 11                         | 22-28-5113      | A-42375-0361       | 29   | 22-28-5293      | A-42375-0379 |
| 12                         | 22-28-5123      | A-42375-0362       | 30   | 22-28-5303      | A-42375-0380 |
| 13                         | 22-28-5133      | A-42375-0363       | 31   | 22-28-5313      | A-42375-0381 |
| 14                         | 22-28-5143      | A-42375-0364       | 32   | 22-28-5323      | A-42375-0382 |
| 15                         | 22-28-5153      | A-42375-0365       | 33   | 22-28-5333      | A-42375-0383 |
| 16                         | 22-28-5163      | A-42375-0366       | 34   | 22-28-5343      | A-42375-0384 |
| 17                         | 22-28-5173      | A-42375-0367       | 35   | 22-28-5353      | A-42375-0385 |
| 18                         | 22-28-5183      | A-42375-0368       | 36   | 22-28-5363      | A-42375-0386 |
| 19                         | 22-28-5193      | A-42375-0369       |      |                 |              |

| ENG. NO: A-42375-0387/0421 |                 |                    |      |                 |              |
|----------------------------|-----------------|--------------------|------|-----------------|--------------|
| HEADER NUMBER:             |                 | 42312-0036         |      |                 |              |
| PIN NUMBER:                |                 | 42663-ADB228       |      |                 |              |
| PIN LENGTH: L              |                 | .465 / 11.81       |      |                 |              |
| MATING LENGTH: M           |                 | .240 / 6.09        |      |                 |              |
| GOLD POINT: G              |                 | .100 / 2.54        |      |                 |              |
| PC TAIL LENGTH: P          |                 | .135 / 3.43        |      |                 |              |
| TIN: T                     |                 | .100 / 2.54        |      |                 |              |
| CKTS:                      |                 | 2-36               |      |                 |              |
| KINKS:                     |                 | SMES-42003         |      |                 |              |
| VOIDED CKTS:               |                 | NONE               |      |                 |              |
| PACKAGING:                 |                 | BULK PK-40873-0041 |      |                 |              |
| CKTS                       | MATERIAL NUMBER | ENG NUMBER         | CKTS | MATERIAL NUMBER | ENG NUMBER   |
| 02                         | 22-28-5026      | A-42375-0387       | 20   | 22-28-5206      | A-42375-0405 |
| 03                         | 22-28-5036      | A-42375-0388       | 21   | 22-28-5216      | A-42375-0406 |
| 04                         | 22-28-5046      | A-42375-0389       | 22   | 22-28-5226      | A-42375-0407 |
| 05                         | 22-28-5056      | A-42375-0390       | 23   | 22-28-5236      | A-42375-0408 |
| 06                         | 22-28-5066      | A-42375-0391       | 24   | 22-28-5246      | A-42375-0409 |
| 07                         | 22-28-5076      | A-42375-0392       | 25   | 22-28-5256      | A-42375-0410 |
| 08                         | 22-28-5086      | A-42375-0393       | 26   | 22-28-5266      | A-42375-0411 |
| 09                         | 22-28-5096      | A-42375-0394       | 27   | 22-28-5276      | A-42375-0412 |
| 10                         | 22-28-5106      | A-42375-0395       | 28   | 22-28-5286      | A-42375-0413 |
| 11                         | 22-28-5116      | A-42375-0396       | 29   | 22-28-5296      | A-42375-0414 |
| 12                         | 22-28-5126      | A-42375-0397       | 30   | 22-28-5306      | A-42375-0415 |
| 13                         | 22-28-5136      | A-42375-0398       | 31   | 22-28-5316      | A-42375-0416 |
| 14                         | 22-28-5146      | A-42375-0399       | 32   | 22-28-5326      | A-42375-0417 |
| 15                         | 22-28-5156      | A-42375-0400       | 33   | 22-28-5336      | A-42375-0418 |
| 16                         | 22-28-5166      | A-42375-0401       | 34   | 22-28-5346      | A-42375-0419 |
| 17                         | 22-28-5176      | A-42375-0402       | 35   | 22-28-5356      | A-42375-0420 |
| 18                         | 22-28-5186      | A-42375-0403       | 36   | 22-28-5366      | A-42375-0421 |
| 19                         | 22-28-5196      | A-42375-0404       |      |                 |              |

|                      |      |                             |   |                |
|----------------------|------|-----------------------------|---|----------------|
| <b>U</b>             | REV: | ECR/ECN INFORMATION:        | TITLE:  | SHEET No.      |
|                      |      | EC No.: <b>UCP2017-2793</b> | <b>KK 100 HEADER ASSY<br/>FLAT VERTICAL<br/>BREAKAWAY</b> | <b>- 7 -</b>   |
|                      |      | DATE: <b>12/20/2021</b>     |   |                |
| DOCUMENT NUMBER:     |      | CREATED / REVISED BY:       | CHECKED BY:   | APPROVED BY:   |
| <b>SD- 42375-001</b> |      | <b>SS06</b>                 | <b>ISHWARG</b>  | <b>ISHWARG</b> |

| ENG. NO: A-42375-0422/0456 |                 |                    |      |                 |              |
|----------------------------|-----------------|--------------------|------|-----------------|--------------|
| HEADER NUMBER:             |                 | 42312-0036         |      |                 |              |
| PIN NUMBER:                |                 | 42663-AYA154       |      |                 |              |
| PIN LENGTH: L              |                 | .545 / 13.84       |      |                 |              |
| MATING LENGTH: M           |                 | .320 / 8.13        |      |                 |              |
| GOLD POINT: G              |                 | N/A                |      |                 |              |
| PC TAIL LENGTH: P          |                 | .135 / 3.43        |      |                 |              |
| TIN: T                     |                 | OVERALL            |      |                 |              |
| CKTS:                      |                 | 2-36               |      |                 |              |
| KINKS:                     |                 | SMES-42003         |      |                 |              |
| VOIDED CKTS:               |                 | NONE               |      |                 |              |
| PACKAGING:                 |                 | BULK PK-40873-0041 |      |                 |              |
| CKTS                       | MATERIAL NUMBER | ENG NUMBER         | CKTS | MATERIAL NUMBER | ENG NUMBER   |
| 02                         | 22-28-5021      | A-42375-0422       | 20   | 22-28-5201      | A-42375-0440 |
| 03                         | 22-28-5031      | A-42375-0423       | 21   | 22-28-5211      | A-42375-0441 |
| 04                         | 22-28-5041      | A-42375-0424       | 22   | 22-28-5221      | A-42375-0442 |
| 05                         | 22-28-5051      | A-42375-0425       | 23   | 22-28-5231      | A-42375-0443 |
| 06                         | 22-28-5061      | A-42375-0426       | 24   | 22-28-5241      | A-42375-0444 |
| 07                         | 22-28-5071      | A-42375-0427       | 25   | 22-28-5251      | A-42375-0445 |
| 08                         | 22-28-5081      | A-42375-0428       | 26   | 22-28-5261      | A-42375-0446 |
| 09                         | 22-28-5091      | A-42375-0429       | 27   | 22-28-5271      | A-42375-0447 |
| 10                         | 22-28-5101      | A-42375-0430       | 28   | 22-28-5281      | A-42375-0448 |
| 11                         | 22-28-5111      | A-42375-0431       | 29   | 22-28-5291      | A-42375-0449 |
| 12                         | 22-28-5121      | A-42375-0432       | 30   | 22-28-5301      | A-42375-0450 |
| 13                         | 22-28-5131      | A-42375-0433       | 31   | 22-28-5311      | A-42375-0451 |
| 14                         | 22-28-5141      | A-42375-0434       | 32   | 22-28-5321      | A-42375-0452 |
| 15                         | 22-28-5151      | A-42375-0435       | 33   | 22-28-5331      | A-42375-0453 |
| 16                         | 22-28-5161      | A-42375-0436       | 34   | 22-28-5341      | A-42375-0454 |
| 17                         | 22-28-5171      | A-42375-0437       | 35   | 22-28-5351      | A-42375-0455 |
| 18                         | 22-28-5181      | A-42375-0438       | 36   | 22-28-5361      | A-42375-0456 |
| 19                         | 22-28-5191      | A-42375-0439       |      |                 |              |

| ENG. NO: A-42375-0457/0491 |                 |                    |      |                 |              |
|----------------------------|-----------------|--------------------|------|-----------------|--------------|
| HEADER NUMBER:             |                 | 42312-0036         |      |                 |              |
| PIN NUMBER:                |                 | 42663-AYB208       |      |                 |              |
| PIN LENGTH: L              |                 | .545 / 13.84       |      |                 |              |
| MATING LENGTH: M           |                 | .320 / 8.13        |      |                 |              |
| GOLD POINT: G              |                 | .140 / 3.56        |      |                 |              |
| PC TAIL LENGTH: P          |                 | .135 / 3.43        |      |                 |              |
| TIN: T                     |                 | .135 / 3.43        |      |                 |              |
| CKTS:                      |                 | 2-36               |      |                 |              |
| KINKS:                     |                 | SMES-42003         |      |                 |              |
| VOIDED CKTS:               |                 | NONE               |      |                 |              |
| PACKAGING:                 |                 | BULK PK-40873-0041 |      |                 |              |
| CKTS                       | MATERIAL NUMBER | ENG NUMBER         | CKTS | MATERIAL NUMBER | ENG NUMBER   |
| 02                         | 22-28-5024      | A-42375-0457       | 20   | 22-28-5204      | A-42375-0475 |
| 03                         | 22-28-5034      | A-42375-0458       | 21   | 22-28-5214      | A-42375-0476 |
| 04                         | 22-28-5044      | A-42375-0459       | 22   | 22-28-5224      | A-42375-0477 |
| 05                         | 22-28-5054      | A-42375-0460       | 23   | 22-28-5234      | A-42375-0478 |
| 06                         | 22-28-5064      | A-42375-0461       | 24   | 22-28-5244      | A-42375-0479 |
| 07                         | 22-28-5074      | A-42375-0462       | 25   | 22-28-5254      | A-42375-0480 |
| 08                         | 22-28-5084      | A-42375-0463       | 26   | 22-28-5264      | A-42375-0481 |
| 09                         | 22-28-5094      | A-42375-0464       | 27   | 22-28-5274      | A-42375-0482 |
| 10                         | 22-28-5104      | A-42375-0465       | 28   | 22-28-5284      | A-42375-0483 |
| 11                         | 22-28-5114      | A-42375-0466       | 29   | 22-28-5294      | A-42375-0484 |
| 12                         | 22-28-5124      | A-42375-0467       | 30   | 22-28-5304      | A-42375-0485 |
| 13                         | 22-28-5134      | A-42375-0468       | 31   | 22-28-5314      | A-42375-0486 |
| 14                         | 22-28-5144      | A-42375-0469       | 32   | 22-28-5324      | A-42375-0487 |
| 15                         | 22-28-5154      | A-42375-0470       | 33   | 22-28-5334      | A-42375-0488 |
| 16                         | 22-28-5164      | A-42375-0471       | 34   | 22-28-5344      | A-42375-0489 |
| 17                         | 22-28-5174      | A-42375-0472       | 35   | 22-28-5354      | A-42375-0490 |
| 18                         | 22-28-5184      | A-42375-0473       | 36   | 22-28-5364      | A-42375-0491 |
| 19                         | 22-28-5194      | A-42375-0474       |      |                 |              |

|   |      |   |   |                                       |
|---|------|---|---|---------------------------------------|
| <b>U</b>  | REV: | <u>ECR/ECN INFORMATION:</u>                 | <u>TITLE:</u>   | <u>SHEET No.</u>                      |
|   |      | EC No.: <b>UCP2017-2793</b>                 | <b>KK 100 HEADER ASSY<br/>FLAT VERTICAL<br/>BREAKAWAY</b> | <b>- 8 -</b>                          |
|   |      | DATE: <b>12/20/2021</b>                     |   |                                       |
| <u>DOCUMENT NUMBER:</u><br><b>SD- 42375-001</b> |      | <u>CREATED / REVISED BY:</u><br><b>SS06</b> | <u>CHECKED BY:</u><br><b>ISHWARG</b>                      | <u>APPROVED BY:</u><br><b>ISHWARG</b> |

| ENG. NO: A-42375-0492/0526 |                 |                    |      |                 |              |
|----------------------------|-----------------|--------------------|------|-----------------|--------------|
| HEADER NUMBER:             |                 | 42312-0036         |      |                 |              |
| PIN NUMBER:                |                 | 42663-AYB228       |      |                 |              |
| PIN LENGTH: L              |                 | .545 / 13.84       |      |                 |              |
| MATING LENGTH: M           |                 | .320 / 8.13        |      |                 |              |
| GOLD POINT: G              |                 | .140 / 3.56        |      |                 |              |
| PC TAIL LENGTH: P          |                 | .135 / 3.43        |      |                 |              |
| TIN: T                     |                 | .135 / 3.43        |      |                 |              |
| CKTS:                      |                 | 2-36               |      |                 |              |
| KINKS:                     |                 | SMES-42003         |      |                 |              |
| VOIDED CKTS:               |                 | NONE               |      |                 |              |
| PACKAGING:                 |                 | BULK PK-40873-0041 |      |                 |              |
| CKTS                       | MATERIAL NUMBER | ENG NUMBER         | CKTS | MATERIAL NUMBER | ENG NUMBER   |
| 02                         | 22-28-5027      | A-42375-0492       | 20   | 22-28-5207      | A-42375-0510 |
| 03                         | 22-28-5037      | A-42375-0493       | 21   | 22-28-5217      | A-42375-0511 |
| 04                         | 22-28-5047      | A-42375-0494       | 22   | 22-28-5227      | A-42375-0512 |
| 05                         | 22-28-5057      | A-42375-0495       | 23   | 22-28-5237      | A-42375-0513 |
| 06                         | 22-28-5067      | A-42375-0496       | 24   | 22-28-5247      | A-42375-0514 |
| 07                         | 22-28-5077      | A-42375-0497       | 25   | 22-28-5257      | A-42375-0515 |
| 08                         | 22-28-5087      | A-42375-0498       | 26   | 22-28-5267      | A-42375-0516 |
| 09                         | 22-28-5097      | A-42375-0499       | 27   | 22-28-5277      | A-42375-0517 |
| 10                         | 22-28-5107      | A-42375-0500       | 28   | 22-28-5287      | A-42375-0518 |
| 11                         | 22-28-5117      | A-42375-0501       | 29   | 22-28-5297      | A-42375-0519 |
| 12                         | 22-28-5127      | A-42375-0502       | 30   | 22-28-5307      | A-42375-0520 |
| 13                         | 22-28-5137      | A-42375-0503       | 31   | 22-28-5317      | A-42375-0521 |
| 14                         | 22-28-5147      | A-42375-0504       | 32   | 22-28-5327      | A-42375-0522 |
| 15                         | 22-28-5157      | A-42375-0505       | 33   | 22-28-5337      | A-42375-0523 |
| 16                         | 22-28-5167      | A-42375-0506       | 34   | 22-28-5347      | A-42375-0524 |
| 17                         | 22-28-5177      | A-42375-0507       | 35   | 22-28-5357      | A-42375-0525 |
| 18                         | 22-28-5187      | A-42375-0508       | 36   | 22-28-5367      | A-42375-0526 |
| 19                         | 22-28-5197      | A-42375-0509       |      |                 |              |

| ENG. NO: A-42375-0527/0561 |                 |                    |      |                 |              |
|----------------------------|-----------------|--------------------|------|-----------------|--------------|
| HEADER NUMBER:             |                 | 42312-0036         |      |                 |              |
| PIN NUMBER:                |                 | 42663-ARA154       |      |                 |              |
| PIN LENGTH: L              |                 | .520 / 13.21       |      |                 |              |
| MATING LENGTH: M           |                 | .295 / 7.49        |      |                 |              |
| GOLD POINT: G              |                 | N/A                |      |                 |              |
| PC TAIL LENGTH: P          |                 | .135 / 3.43        |      |                 |              |
| TIN: T                     |                 | OVERALL            |      |                 |              |
| CKTS:                      |                 | 2-36               |      |                 |              |
| KINKS:                     |                 | SMES-42003         |      |                 |              |
| VOIDED CKTS:               |                 | NONE               |      |                 |              |
| PACKAGING:                 |                 | BULK PK-40873-0041 |      |                 |              |
| CKTS                       | MATERIAL NUMBER | ENG NUMBER         | CKTS | MATERIAL NUMBER | ENG NUMBER   |
| 02                         | 22-28-5022      | A-42375-0527       | 20   | 22-28-5202      | A-42375-0545 |
| 03                         | 22-28-5032      | A-42375-0528       | 21   | 22-28-5212      | A-42375-0546 |
| 04                         | 22-28-5042      | A-42375-0529       | 22   | 22-28-5222      | A-42375-0547 |
| 05                         | 22-28-5052      | A-42375-0530       | 23   | 22-28-5232      | A-42375-0548 |
| 06                         | 22-28-5062      | A-42375-0531       | 24   | 22-28-5242      | A-42375-0549 |
| 07                         | 22-28-5072      | A-42375-0532       | 25   | 22-28-5252      | A-42375-0550 |
| 08                         | 22-28-5082      | A-42375-0533       | 26   | 22-28-5262      | A-42375-0551 |
| 09                         | 22-28-5092      | A-42375-0534       | 27   | 22-28-5272      | A-42375-0552 |
| 10                         | 22-28-5102      | A-42375-0535       | 28   | 22-28-5282      | A-42375-0553 |
| 11                         | 22-28-5112      | A-42375-0536       | 29   | 22-28-5292      | A-42375-0554 |
| 12                         | 22-28-5122      | A-42375-0537       | 30   | 22-28-5302      | A-42375-0555 |
| 13                         | 22-28-5132      | A-42375-0538       | 31   | 22-28-5312      | A-42375-0556 |
| 14                         | 22-28-5142      | A-42375-0539       | 32   | 22-28-5322      | A-42375-0557 |
| 15                         | 22-28-5152      | A-42375-0540       | 33   | 22-28-5332      | A-42375-0558 |
| 16                         | 22-28-5162      | A-42375-0541       | 34   | 22-28-5342      | A-42375-0559 |
| 17                         | 22-28-5172      | A-42375-0542       | 35   | 22-28-5352      | A-42375-0560 |
| 18                         | 22-28-5182      | A-42375-0543       | 36   | 22-28-5362      | A-42375-0561 |
| 19                         | 22-28-5192      | A-42375-0544       |      |                 |              |

|   |      |   |   |                                       |
|---|------|---|---|---------------------------------------|
| <b>U</b>  | REV: | <u>ECR/ECN INFORMATION:</u>                 | <u>TITLE:</u>   | <u>SHEET No.</u>                      |
|   |      | EC No.: <b>UCP2017-2793</b>                 | <b>KK 100 HEADER ASSY<br/>FLAT VERTICAL<br/>BREAKAWAY</b> | <b>- 9 -</b>                          |
|   |      | DATE: <b>12/20/2021</b>                     |   |                                       |
| <u>DOCUMENT NUMBER:</u><br><b>SD- 42375-001</b> |      | <u>CREATED / REVISED BY:</u><br><b>SS06</b> | <u>CHECKED BY:</u><br><b>ISHWARG</b>                      | <u>APPROVED BY:</u><br><b>ISHWARG</b> |

| ENG. NO: A-42375-0562/0596 |                 |                    |      |                 |              |
|----------------------------|-----------------|--------------------|------|-----------------|--------------|
| HEADER NUMBER:             |                 | 42312-0036         |      |                 |              |
| PIN NUMBER:                |                 | 42663-ARB208       |      |                 |              |
| PIN LENGTH: L              |                 | .520 / 13.21       |      |                 |              |
| MATING LENGTH: M           |                 | .295 / 7.49        |      |                 |              |
| GOLD POINT: G              |                 | .140 / 3.56        |      |                 |              |
| PC TAIL LENGTH: P          |                 | .135 / 3.43        |      |                 |              |
| TIN: T                     |                 | .135 / 3.43        |      |                 |              |
| CKTS:                      |                 | 2-36               |      |                 |              |
| KINKS:                     |                 | SMES-42003         |      |                 |              |
| VOIDED CKTS:               |                 | NONE               |      |                 |              |
| PACKAGING:                 |                 | BULK PK-40873-0041 |      |                 |              |
| CKTS                       | MATERIAL NUMBER | ENG NUMBER         | CKTS | MATERIAL NUMBER | ENG NUMBER   |
| 02                         | 22-28-5025      | A-42375-0562       | 20   | 22-28-5205      | A-42375-0580 |
| 03                         | 22-28-5035      | A-42375-0563       | 21   | 22-28-5215      | A-42375-0581 |
| 04                         | 22-28-5045      | A-42375-0564       | 22   | 22-28-5225      | A-42375-0582 |
| 05                         | 22-28-5055      | A-42375-0565       | 23   | 22-28-5235      | A-42375-0583 |
| 06                         | 22-28-5065      | A-42375-0566       | 24   | 22-28-5245      | A-42375-0584 |
| 07                         | 22-28-5075      | A-42375-0567       | 25   | 22-28-5255      | A-42375-0585 |
| 08                         | 22-28-5085      | A-42375-0568       | 26   | 22-28-5265      | A-42375-0586 |
| 09                         | 22-28-5095      | A-42375-0569       | 27   | 22-28-5275      | A-42375-0587 |
| 10                         | 22-28-5105      | A-42375-0570       | 28   | 22-28-5285      | A-42375-0588 |
| 11                         | 22-28-5115      | A-42375-0571       | 29   | 22-28-5295      | A-42375-0589 |
| 12                         | 22-28-5125      | A-42375-0572       | 30   | 22-28-5305      | A-42375-0590 |
| 13                         | 22-28-5135      | A-42375-0573       | 31   | 22-28-5315      | A-42375-0591 |
| 14                         | 22-28-5145      | A-42375-0574       | 32   | 22-28-5325      | A-42375-0592 |
| 15                         | 22-28-5155      | A-42375-0575       | 33   | 22-28-5335      | A-42375-0593 |
| 16                         | 22-28-5165      | A-42375-0576       | 34   | 22-28-5345      | A-42375-0594 |
| 17                         | 22-28-5175      | A-42375-0577       | 35   | 22-28-5355      | A-42375-0595 |
| 18                         | 22-28-5185      | A-42375-0578       | 36   | 22-28-5365      | A-42375-0596 |
| 19                         | 22-28-5195      | A-42375-0579       |      |                 |              |

| ENG. NO: A-42375-0597/0631 |                 |                    |      |                 |              |
|----------------------------|-----------------|--------------------|------|-----------------|--------------|
| HEADER NUMBER:             |                 | 42312-0036         |      |                 |              |
| PIN NUMBER:                |                 | 42663-ARB228       |      |                 |              |
| PIN LENGTH: L              |                 | .520 / 13.21       |      |                 |              |
| MATING LENGTH: M           |                 | .295 / 7.49        |      |                 |              |
| GOLD POINT: G              |                 | .140 / 3.56        |      |                 |              |
| PC TAIL LENGTH: P          |                 | .135 / 3.43        |      |                 |              |
| TIN: T                     |                 | .135 / 3.43        |      |                 |              |
| CKTS:                      |                 | 2-36               |      |                 |              |
| KINKS:                     |                 | SMES-42003         |      |                 |              |
| VOIDED CKTS:               |                 | NONE               |      |                 |              |
| PACKAGING:                 |                 | BULK PK-40873-0041 |      |                 |              |
| CKTS                       | MATERIAL NUMBER | ENG NUMBER         | CKTS | MATERIAL NUMBER | ENG NUMBER   |
| 02                         | 22-28-5028      | A-42375-0597       | 20   | 22-28-5208      | A-42375-0615 |
| 03                         | 22-28-5038      | A-42375-0598       | 21   | 22-28-5218      | A-42375-0616 |
| 04                         | 22-28-5048      | A-42375-0599       | 22   | 22-28-5228      | A-42375-0617 |
| 05                         | 22-28-5058      | A-42375-0600       | 23   | 22-28-5238      | A-42375-0618 |
| 06                         | 22-28-5068      | A-42375-0601       | 24   | 22-28-5248      | A-42375-0619 |
| 07                         | 22-28-5078      | A-42375-0602       | 25   | 22-28-5258      | A-42375-0620 |
| 08                         | 22-28-5088      | A-42375-0603       | 26   | 22-28-5268      | A-42375-0621 |
| 09                         | 22-28-5098      | A-42375-0604       | 27   | 22-28-5278      | A-42375-0622 |
| 10                         | 22-28-5108      | A-42375-0605       | 28   | 22-28-5288      | A-42375-0623 |
| 11                         | 22-28-5118      | A-42375-0606       | 29   | 22-28-5298      | A-42375-0624 |
| 12                         | 22-28-5128      | A-42375-0607       | 30   | 22-28-5308      | A-42375-0625 |
| 13                         | 22-28-5138      | A-42375-0608       | 31   | 22-28-5318      | A-42375-0626 |
| 14                         | 22-28-5148      | A-42375-0609       | 32   | 22-28-5328      | A-42375-0627 |
| 15                         | 22-28-5158      | A-42375-0610       | 33   | 22-28-5338      | A-42375-0628 |
| 16                         | 22-28-5168      | A-42375-0611       | 34   | 22-28-5348      | A-42375-0629 |
| 17                         | 22-28-5178      | A-42375-0612       | 35   | 22-28-5358      | A-42375-0630 |
| 18                         | 22-28-5188      | A-42375-0613       | 36   | 22-28-5368      | A-42375-0631 |
| 19                         | 22-28-5198      | A-42375-0614       |      |                 |              |

|                         |      |                              |                    |   |                  |
|-------------------------|------|------------------------------|--------------------|---|------------------|
| <b>U</b>                | REV: | <u>ECR/ECN INFORMATION:</u>  | <u>TITLE:</u>      | <b>KK 100 HEADER ASSY<br/>FLAT VERTICAL<br/>BREAKAWAY</b> | <u>SHEET No.</u> |
|                         |      | EC No.: <b>UCP2017-2793</b>  |                    |   | <b>- 10 -</b>    |
|                         |      | DATE: <b>12/20/2021</b>      |                    |   |                  |
| <u>DOCUMENT NUMBER:</u> |      | <u>CREATED / REVISED BY:</u> | <u>CHECKED BY:</u> | <u>APPROVED BY:</u>                                       |                  |
| <b>SD- 42375-001</b>    |      | <b>SS06</b>                  | <b>ISHWARG</b>     | <b>ISHWARG</b>  |                  |

ENG. NO: A-42375-0667/0699

|                   |                    |
|-------------------|--------------------|
| HEADER NUMBER:    | 42312-0036         |
| PIN NUMBER:       | 42663-ABB208       |
| PIN LENGTH: L     | .455 / 11.56       |
| MATING LENGTH: M  | .240 / 6.09        |
| GOLD POINT: G     | .100 / 2.54        |
| PC TAIL LENGTH: P | .125 / 3.18        |
| TIN: T            | .100 / 2.54        |
| CKTS:             | 4-36               |
| KINKS:            | NO                 |
| VOIDED CKTS:      | 4                  |
| PACKAGING:        | BULK PK-40873-0041 |

| CKTS | MATERIAL NUMBER | ENG NUMBER   | CKTS | MATERIAL NUMBER | ENG NUMBER   |
|------|-----------------|--------------|------|-----------------|--------------|
| 02   |                 |              | 20   | 42375-0683      | A-42375-0683 |
| 03   |                 |              | 21   | 42375-0684      | A-42375-0684 |
| 04   | 42375-0667      | A-42375-0667 | 22   | 42375-0685      | A-42375-0685 |
| 05   | 42375-0668      | A-42375-0668 | 23   | 42375-0686      | A-42375-0686 |
| 06   | 22-30-3060      | A-42375-0669 | 24   | 42375-0687      | A-42375-0687 |
| 07   | 42375-0670      | A-42375-0670 | 25   | 42375-0688      | A-42375-0688 |
| 08   | 42375-0671      | A-42375-0671 | 26   | 42375-0689      | A-42375-0689 |
| 09   | 42375-0672      | A-42375-0672 | 27   | 42375-0690      | A-42375-0690 |
| 10   | 42375-0673      | A-42375-0673 | 28   | 42375-0691      | A-42375-0691 |
| 11   | 42375-0674      | A-42375-0674 | 29   | 42375-0692      | A-42375-0692 |
| 12   | 22-30-3120      | A-42375-0675 | 30   | 42375-0693      | A-42375-0693 |
| 13   | 42375-0676      | A-42375-0676 | 31   | 42375-0694      | A-42375-0694 |
| 14   | 42375-0677      | A-42375-0677 | 32   | 42375-0695      | A-42375-0695 |
| 15   | 42375-0678      | A-42375-0678 | 33   | 42375-0696      | A-42375-0696 |
| 16   | 42375-0679      | A-42375-0679 | 34   | 42375-0697      | A-42375-0697 |
| 17   | 42375-0680      | A-42375-0680 | 35   | 42375-0698      | A-42375-0698 |
| 18   | 42375-0681      | A-42375-0681 | 36   | 42375-0699      | A-42375-0699 |
| 19   | 42375-0682      | A-42375-0682 |      |                 |              |

ENG. NO: A-42375-0700/0732

|                   |                    |
|-------------------|--------------------|
| HEADER NUMBER:    | 42312-0036         |
| PIN NUMBER:       | 42663-ADB208       |
| PIN LENGTH: L     | .465 / 11.81       |
| MATING LENGTH: M  | .240 / 6.09        |
| GOLD POINT: G     | .100 / 2.54        |
| PC TAIL LENGTH: P | .135 / 3.43        |
| TIN: T            | .100 / 2.54        |
| CKTS:             | 4-36               |
| KINKS:            | SMES-42003         |
| VOIDED CKTS:      | 4                  |
| PACKAGING:        | BULK PK-40873-0041 |

| CKTS | MATERIAL NUMBER | ENG NUMBER   | CKTS | MATERIAL NUMBER | ENG NUMBER   |
|------|-----------------|--------------|------|-----------------|--------------|
| 02   |                 |              | 20   | 42375-0716      | A-42375-0716 |
| 03   |                 |              | 21   | 42375-0717      | A-42375-0717 |
| 04   | 42375-0700      | A-42375-0700 | 22   | 42375-0718      | A-42375-0718 |
| 05   | 42375-0701      | A-42375-0701 | 23   | 42375-0719      | A-42375-0719 |
| 06   | 22-30-3061      | A-42375-0702 | 24   | 42375-0720      | A-42375-0720 |
| 07   | 42375-0703      | A-42375-0703 | 25   | 42375-0721      | A-42375-0721 |
| 08   | 42375-0704      | A-42375-0704 | 26   | 42375-0722      | A-42375-0722 |
| 09   | 42375-0705      | A-42375-0705 | 27   | 42375-0723      | A-42375-0723 |
| 10   | 42375-0706      | A-42375-0706 | 28   | 42375-0724      | A-42375-0724 |
| 11   | 42375-0707      | A-42375-0707 | 29   | 42375-0725      | A-42375-0725 |
| 12   | 42375-0708      | A-42375-0708 | 30   | 42375-0726      | A-42375-0726 |
| 13   | 42375-0709      | A-42375-0709 | 31   | 42375-0727      | A-42375-0727 |
| 14   | 42375-0710      | A-42375-0710 | 32   | 42375-0728      | A-42375-0728 |
| 15   | 42375-0711      | A-42375-0711 | 33   | 42375-0729      | A-42375-0729 |
| 16   | 42375-0712      | A-42375-0712 | 34   | 42375-0730      | A-42375-0730 |
| 17   | 42375-0713      | A-42375-0713 | 35   | 42375-0731      | A-42375-0731 |
| 18   | 42375-0714      | A-42375-0714 | 36   | 42375-0732      | A-42375-0732 |
| 19   | 42375-0715      | A-42375-0715 |      |                 |              |

|                         |      |                              |                    |   |                  |
|-------------------------|------|------------------------------|--------------------|---|------------------|
| <b>U</b>                | REV: | <u>ECR/ECN INFORMATION:</u>  | <u>TITLE:</u>      | <b>KK 100 HEADER ASSY<br/>FLAT VERTICAL<br/>BREAKAWAY</b> | <u>SHEET No.</u> |
|                         |      | EC No.: <b>UCP2017-2793</b>  |                    |   | <b>- 11 -</b>    |
|                         |      | DATE: <b>12/20/2021</b>      |                    |   |                  |
| <u>DOCUMENT NUMBER:</u> |      | <u>CREATED / REVISED BY:</u> | <u>CHECKED BY:</u> | <u>APPROVED BY:</u>                                       |                  |
| <b>SD- 42375-001</b>    |      | <b>SS06</b>                  | <b>ISHWARG</b>     | <b>ISHWARG</b>  |                  |

ENG. NO: A-42375-0836/0870

|                   |                    |
|-------------------|--------------------|
| HEADER NUMBER:    | 42312-0036         |
| PIN NUMBER:       | 42663-BSA154       |
| PIN LENGTH: L     | .630 / 16.00       |
| MATING LENGTH: M  | .405/10.29         |
| GOLD POINT: G     | N/A                |
| PC TAIL LENGTH: P | .135/3.43          |
| TIN: T            | OVERALL            |
| CKTS:             | 2-36               |
| KINKS:            | SMES-42003         |
| VOIDED CKTS:      | NONE               |
| PACKAGING:        | BULK PK-40873-0041 |

| CKTS | MATERIAL NUMBER | ENG NUMBER   | CKTS | MATERIAL NUMBER | ENG NUMBER   |
|------|-----------------|--------------|------|-----------------|--------------|
| 02   |                 | A-42375-0836 | 20   | 22-30-3203      | A-42375-0854 |
| 03   | 22-30-3033      | A-42375-0837 | 21   | 22-30-3213      | A-42375-0855 |
| 04   | 22-30-3043      | A-42375-0838 | 22   | 22-30-3223      | A-42375-0856 |
| 05   | 22-30-3053      | A-42375-0839 | 23   | 22-30-3233      | A-42375-0857 |
| 06   | 22-30-3063      | A-42375-0840 | 24   | 22-30-3243      | A-42375-0858 |
| 07   | 22-30-3073      | A-42375-0841 | 25   | 22-30-3253      | A-42375-0859 |
| 08   | 22-30-3083      | A-42375-0842 | 26   | 22-30-3263      | A-42375-0860 |
| 09   | 22-30-3093      | A-42375-0843 | 27   | 22-30-3273      | A-42375-0861 |
| 10   | 22-30-3103      | A-42375-0844 | 28   | 22-30-3283      | A-42375-0862 |
| 11   | 22-30-3113      | A-42375-0845 | 29   | 22-30-3293      | A-42375-0863 |
| 12   | 22-30-3123      | A-42375-0846 | 30   | 22-30-3303      | A-42375-0864 |
| 13   | 22-30-3133      | A-42375-0847 | 31   | 22-30-3313      | A-42375-0865 |
| 14   | 22-30-3143      | A-42375-0848 | 32   | 22-30-3323      | A-42375-0866 |
| 15   | 22-30-3153      | A-42375-0849 | 33   | 22-30-3333      | A-42375-0867 |
| 16   | 22-30-3163      | A-42375-0850 | 34   | 22-30-3343      | A-42375-0868 |
| 17   | 22-30-3173      | A-42375-0851 | 35   | 22-30-3353      | A-42375-0869 |
| 18   | 22-30-3183      | A-42375-0852 | 36   | 22-30-3363      | A-42375-0870 |
| 19   | 22-30-3193      | A-42375-0853 |      |                 |              |
|      |                 |              |      |                 |              |

|  |  |   |                                |
|--|--|---|--------------------------------|
| REV:<br><b>U</b>                         | ECR/ECN INFORMATION:<br>EC No.: <b>UCP2017-2793</b><br>DATE: <b>12/20/2021</b> | TITLE:<br><b>KK 100 HEADER ASSY<br/>FLAT VERTICAL<br/>BREAKAWAY</b> | SHEET No.<br><b>- 12 -</b>     |
| DOCUMENT NUMBER:<br><b>SD- 42375-001</b> | CREATED / REVISED BY:<br><b>SS06</b>   | CHECKED BY:<br><b>ISHWARG</b>                                       | APPROVED BY:<br><b>ISHWARG</b> |

| ENG. NO: A-42375-0871/0904 |                 |                    |      |                 |              |
|----------------------------|-----------------|--------------------|------|-----------------|--------------|
| HEADER NUMBER:             |                 | 42312-0036         |      |                 |              |
| PIN NUMBER:                |                 | 42663-ATA154       |      |                 |              |
| PIN LENGTH: L              |                 | .530 / 13.46       |      |                 |              |
| MATING LENGTH: M           |                 | .320 / 8.13        |      |                 |              |
| GOLD POINT: G              |                 | N/A                |      |                 |              |
| PC TAIL LENGTH: P          |                 | .120 / 3.05        |      |                 |              |
| TIN: T                     |                 | OVERALL            |      |                 |              |
| CKTS:                      |                 | 3-36               |      |                 |              |
| KINKS:                     |                 | NO                 |      |                 |              |
| VOIDED CKTS:               |                 | 2                  |      |                 |              |
| PACKAGING:                 |                 | BULK PK-40873-0041 |      |                 |              |
| CKTS                       | MATERIAL NUMBER | ENG NUMBER         | CKTS | MATERIAL NUMBER | ENG NUMBER   |
| 02                         |                 |                    | 20   | 22-30-3204      | A-42375-0888 |
| 03                         | 22-30-3034      | A-42375-0871       | 21   | 22-30-3214      | A-42375-0889 |
| 04                         | 22-30-3044      | A-42375-0872       | 22   | 22-30-3224      | A-42375-0890 |
| 05                         | 22-30-3054      | A-42375-0873       | 23   | 22-30-3234      | A-42375-0891 |
| 06                         | 22-30-3064      | A-42375-0874       | 24   | 22-30-3244      | A-42375-0892 |
| 07                         | 22-30-3074      | A-42375-0875       | 25   | 22-30-3254      | A-42375-0893 |
| 08                         | 22-30-3084      | A-42375-0876       | 26   | 22-30-3264      | A-42375-0894 |
| 09                         | 22-30-3094      | A-42375-0877       | 27   | 22-30-3274      | A-42375-0895 |
| 10                         | 22-30-3104      | A-42375-0878       | 28   | 22-30-3284      | A-42375-0896 |
| 11                         | 22-30-3114      | A-42375-0879       | 29   | 22-30-3294      | A-42375-0897 |
| 12                         | 22-30-3124      | A-42375-0880       | 30   | 22-30-3304      | A-42375-0898 |
| 13                         | 22-30-3134      | A-42375-0881       | 31   | 22-30-3314      | A-42375-0899 |
| 14                         | 22-30-3144      | A-42375-0882       | 32   | 22-30-3324      | A-42375-0900 |
| 15                         | 22-30-3154      | A-42375-0883       | 33   | 22-30-3334      | A-42375-0901 |
| 16                         | 22-30-3164      | A-42375-0884       | 34   | 22-30-3344      | A-42375-0902 |
| 17                         | 22-30-3174      | A-42375-0885       | 35   | 22-30-3354      | A-42375-0903 |
| 18                         | 22-30-3184      | A-42375-0886       | 36   | 22-30-3364      | A-42375-0904 |
| 19                         | 22-30-3194      | A-42375-0887       |      |                 |              |

| ENG. NO: A-42375-0973/1001 |                 |                    |      |                 |              |
|----------------------------|-----------------|--------------------|------|-----------------|--------------|
| HEADER NUMBER:             |                 | 42312-0036         |      |                 |              |
| PIN NUMBER:                |                 | 42663-ABA154       |      |                 |              |
| PIN LENGTH: L              |                 | .455 / 11.56       |      |                 |              |
| MATING LENGTH: M           |                 | .240 / 6.09        |      |                 |              |
| GOLD POINT: G              |                 | N/A                |      |                 |              |
| PC TAIL LENGTH: P          |                 | .125 / 3.18        |      |                 |              |
| TIN: T                     |                 | OVERALL            |      |                 |              |
| CKTS:                      |                 | 8-36               |      |                 |              |
| KINKS:                     |                 | NO                 |      |                 |              |
| VOIDED CKTS:               |                 | 3,8                |      |                 |              |
| PACKAGING:                 |                 | BULK PK-40873-0041 |      |                 |              |
| CKTS                       | MATERIAL NUMBER | ENG NUMBER         | CKTS | MATERIAL NUMBER | ENG NUMBER   |
| 02                         |                 |                    | 20   | 42375-0985      | A-42375-0985 |
| 03                         |                 |                    | 21   | 42375-0986      | A-42375-0986 |
| 04                         |                 |                    | 22   | 42375-0987      | A-42375-0987 |
| 05                         |                 |                    | 23   | 42375-0988      | A-42375-0988 |
| 06                         |                 |                    | 24   | 42375-0989      | A-42375-0989 |
| 07                         |                 |                    | 25   | 42375-0990      | A-42375-0990 |
| 08                         | 42375-0973      | A-42375-0973       | 26   | 42375-0991      | A-42375-0991 |
| 09                         | 42375-0974      | A-42375-0974       | 27   | 42375-0992      | A-42375-0992 |
| 10                         | 22-30-3107      | A-42375-0975       | 28   | 42375-0993      | A-42375-0993 |
| 11                         | 42375-0976      | A-42375-0976       | 29   | 42375-0994      | A-42375-0994 |
| 12                         | 42375-0977      | A-42375-0977       | 30   | 42375-0995      | A-42375-0995 |
| 13                         | 42375-0978      | A-42375-0978       | 31   | 42375-0996      | A-42375-0996 |
| 14                         | 42375-0979      | A-42375-0979       | 32   | 42375-0997      | A-42375-0997 |
| 15                         | 42375-0980      | A-42375-0980       | 33   | 42375-0998      | A-42375-0998 |
| 16                         | 42375-0981      | A-42375-0981       | 34   | 42375-0999      | A-42375-0999 |
| 17                         | 42375-0982      | A-42375-0982       | 35   | 42375-1000      | A-42375-1000 |
| 18                         | 42375-0983      | A-42375-0983       | 36   | 42375-1001      | A-42375-1001 |
| 19                         | 42375-0984      | A-42375-0984       |      |                 |              |

|   |      |   |   |                                       |
|---|------|---|---|---------------------------------------|
| <b>U</b>  | REV: | <u>ECR/ECN INFORMATION:</u>                 | <u>TITLE:</u>   | <u>SHEET No.</u>                      |
|   |      | EC No.: <b>UCP2017-2793</b>                 | <b>KK 100 HEADER ASSY<br/>FLAT VERTICAL<br/>BREAKAWAY</b> | <b>- 13 -</b>                         |
|   |      | DATE: <b>12/20/2021</b>                     |   |                                       |
| <u>DOCUMENT NUMBER:</u><br><b>SD- 42375-001</b> |      | <u>CREATED / REVISED BY:</u><br><b>SS06</b> | <u>CHECKED BY:</u><br><b>ISHWARG</b>                      | <u>APPROVED BY:</u><br><b>ISHWARG</b> |

ENG. NO: A-42375-1105/1139

|                   |                    |
|-------------------|--------------------|
| HEADER NUMBER:    | 42312-0036         |
| PIN NUMBER:       | 42663-ABB208       |
| PIN LENGTH: L     | .455 / 11.56       |
| MATING LENGTH: M  | .240 / 6.09        |
| GOLD POINT: G     | .100 / 2.54        |
| PC TAIL LENGTH: P | .125 / 3.18        |
| TIN: T            | .100 / 2.54        |
| CKTS:             | 2-36               |
| KINKS:            | NO                 |
| VOIDED CKTS:      | 2                  |
| PACKAGING:        | BULK PK-40873-0041 |

| CKTS | MATERIAL NUMBER | ENG NUMBER   | CKTS | MATERIAL NUMBER | ENG NUMBER   |
|------|-----------------|--------------|------|-----------------|--------------|
| 02   | 42375-1105      | A-42375-1105 | 20   | 42375-1123      | A-42375-1123 |
| 03   | 42375-1106      | A-42375-1106 | 21   | 42375-1124      | A-42375-1124 |
| 04   | 42375-1107      | A-42375-1107 | 22   | 42375-1125      | A-42375-1125 |
| 05   | 42375-1108      | A-42375-1108 | 23   | 42375-1126      | A-42375-1126 |
| 06   | 42375-1109      | A-42375-1109 | 24   | 42375-1127      | A-42375-1127 |
| 07   | 42375-1110      | A-42375-1110 | 25   | 42375-1128      | A-42375-1128 |
| 08   | 42375-1111      | A-42375-1111 | 26   | 42375-1129      | A-42375-1129 |
| 09   | 22-30-3099      | A-42375-1112 | 27   | 42375-1130      | A-42375-1130 |
| 10   | 42375-1113      | A-42375-1113 | 28   | 42375-1131      | A-42375-1131 |
| 11   | 42375-1114      | A-42375-1114 | 29   | 42375-1132      | A-42375-1132 |
| 12   | 42375-1115      | A-42375-1115 | 30   | 42375-1133      | A-42375-1133 |
| 13   | 42375-1116      | A-42375-1116 | 31   | 42375-1134      | A-42375-1134 |
| 14   | 42375-1117      | A-42375-1117 | 32   | 42375-1135      | A-42375-1135 |
| 15   | 42375-1118      | A-42375-1118 | 33   | 42375-1136      | A-42375-1136 |
| 16   | 42375-1119      | A-42375-1119 | 34   | 42375-1137      | A-42375-1137 |
| 17   | 42375-1120      | A-42375-1120 | 35   | 42375-1138      | A-42375-1138 |
| 18   | 42375-1121      | A-42375-1121 | 36   | 42375-1139      | A-42375-1139 |
| 19   | 42375-1122      | A-42375-1122 |      |                 |              |

ENG. NO: 42375-1244/1278

|                   |                    |
|-------------------|--------------------|
| HEADER NUMBER:    | 42312-0036         |
| PIN NUMBER:       | 42663-ABA154       |
| PIN LENGTH: L     | .455 / 11.56       |
| MATING LENGTH: M  | .240 / 6.09        |
| GOLD POINT: G     | N/A                |
| PC TAIL LENGTH: P | .125 / 3.18        |
| TIN: T            | OVERALL            |
| CKTS:             | 2-36               |
| KINKS:            | NO                 |
| VOIDED CKTS:      | 2                  |
| PACKAGING:        | BULK PK-40873-0041 |

| CKTS | ITEM NUMBER | CKTS | ITEM NUMBER |
|------|-------------|------|-------------|
| 02   | 42375-1244  | 20   | 42375-1262  |
| 03   | 42375-1245  | 21   | 42375-1263  |
| 04   | 42375-1246  | 22   | 42375-1264  |
| 05   | 42375-1247  | 23   | 42375-1265  |
| 06   | 42375-1248  | 24   | 42375-1266  |
| 07   | 42375-1249  | 25   | 42375-1267  |
| 08   | 42375-1250  | 26   | 42375-1268  |
| 09   | 42375-1251  | 27   | 42375-1269  |
| 10   | 42375-1252  | 28   | 42375-1270  |
| 11   | 42375-1253  | 29   | 42375-1271  |
| 12   | 42375-1254  | 30   | 42375-1272  |
| 13   | 42375-1255  | 31   | 42375-1273  |
| 14   | 42375-1256  | 32   | 42375-1274  |
| 15   | 42375-1257  | 33   | 42375-1275  |
| 16   | 42375-1258  | 34   | 42375-1276  |
| 17   | 42375-1259  | 35   | 42375-1277  |
| 18   | 42375-1260  | 36   | 42375-1278  |
| 19   | 42375-1261  |      |             |

|                         |      |                              |                    |   |                  |
|-------------------------|------|------------------------------|--------------------|---|------------------|
| <b>U</b>                | REV: | <u>ECR/ECN INFORMATION:</u>  | <u>TITLE:</u>      | <b>KK 100 HEADER ASSY<br/>FLAT VERTICAL<br/>BREAKAWAY</b> | <u>SHEET No.</u> |
|                         |      | EC No.: <b>UCP2017-2793</b>  |                    |   | <b>- 14 -</b>    |
|                         |      | DATE: <b>12/20/2021</b>      |                    |   |                  |
| <u>DOCUMENT NUMBER:</u> |      | <u>CREATED / REVISED BY:</u> | <u>CHECKED BY:</u> | <u>APPROVED BY:</u>                                       |                  |
| <b>SD- 42375-001</b>    |      | <b>SS06</b>                  | <b>ISHWARG</b>     | <b>ISHWARG</b>  |                  |



ENG. NO: 42375-1349/1382

|                   |                    |
|-------------------|--------------------|
| HEADER NUMBER:    | 42312-0036         |
| PIN NUMBER:       | 42663-ABA154       |
| PIN LENGTH: L     | .455 / 11.56       |
| MATING LENGTH: M  | .230 / 5.84        |
| GOLD POINT: G     | N/A                |
| PC TAIL LENGTH: P | .135 / 3.43        |
| TIN: T            | OVERALL            |
| CKTS:             | 3-36               |
| KINKS:            | SMES-42003         |
| VOIDED CKTS:      | 2                  |
| PACKAGING:        | BULK PK-40873-0041 |

| CKTS | ITEM NUMBER | CKTS | ITEM NUMBER |
|------|-------------|------|-------------|
| 02   |             | 20   | 42375-1366  |
| 03   | 42375-1349  | 21   | 42375-1367  |
| 04   | 42375-1350  | 22   | 42375-1368  |
| 05   | 42375-1351  | 23   | 42375-1369  |
| 06   | 42375-1352  | 24   | 42375-1370  |
| 07   | 42375-1353  | 25   | 42375-1371  |
| 08   | 42375-1354  | 26   | 42375-1372  |
| 09   | 42375-1355  | 27   | 42375-1373  |
| 10   | 42375-1356  | 28   | 42375-1374  |
| 11   | 42375-1357  | 29   | 42375-1375  |
| 12   | 42375-1358  | 30   | 42375-1376  |
| 13   | 42375-1359  | 31   | 42375-1377  |
| 14   | 42375-1360  | 32   | 42375-1378  |
| 15   | 42375-1361  | 33   | 42375-1379  |
| 16   | 42375-1362  | 34   | 42375-1380  |
| 17   | 42375-1363  | 35   | 42375-1381  |
| 18   | 42375-1364  | 36   | 42375-1382  |
| 19   | 42375-1365  |      |             |

ENG. NO: 42375-1515/1548

|                   |                    |
|-------------------|--------------------|
| HEADER NUMBER:    | 42312-0036         |
| PIN NUMBER:       | 42663-ABB208       |
| PIN LENGTH: L     | .455 / 11.56       |
| MATING LENGTH: M  | .230 / 5.84        |
| GOLD POINT: G     | .140 / 3.56        |
| PC TAIL LENGTH: P | .135 / 3.43        |
| TIN: T            | .100 / 2.54        |
| CKTS:             | 3-36               |
| KINKS:            | SMES-42003         |
| VOIDED CKTS:      | 2                  |
| PACKAGING:        | BULK PK-40873-0041 |

| CKTS | ITEM NUMBER | CKTS | ITEM NUMBER |
|------|-------------|------|-------------|
| 02   |             | 20   | 42375-1532  |
| 03   | 42375-1515  | 21   | 42375-1533  |
| 04   | 42375-1516  | 22   | 42375-1534  |
| 05   | 42375-1517  | 23   | 42375-1535  |
| 06   | 42375-1518  | 24   | 42375-1536  |
| 07   | 42375-1519  | 25   | 42375-1537  |
| 08   | 42375-1520  | 26   | 42375-1538  |
| 09   | 42375-1521  | 27   | 42375-1539  |
| 10   | 42375-1522  | 28   | 42375-1540  |
| 11   | 42375-1523  | 29   | 42375-1541  |
| 12   | 42375-1524  | 30   | 42375-1542  |
| 13   | 42375-1525  | 31   | 42375-1543  |
| 14   | 42375-1526  | 32   | 42375-1544  |
| 15   | 42375-1527  | 33   | 42375-1545  |
| 16   | 42375-1528  | 34   | 42375-1546  |
| 17   | 42375-1529  | 35   | 42375-1547  |
| 18   | 42375-1530  | 36   | 42375-1548  |
| 19   | 42375-1531  |      |             |

|  |  |   |                                |
|--|--|---|--------------------------------|
| REV:<br><b>U</b>                         | ECR/ECN INFORMATION:<br>EC No.: <b>UCP2017-2793</b><br>DATE: <b>12/20/2021</b> | TITLE:<br><b>KK 100 HEADER ASSY<br/>FLAT VERTICAL<br/>BREAKAWAY</b> | SHEET No.<br><b>- 15 -</b>     |
| DOCUMENT NUMBER:<br><b>SD- 42375-001</b> | CREATED / REVISED BY:<br><b>SS06</b>   | CHECKED BY:<br><b>ISHWARG</b>                                       | APPROVED BY:<br><b>ISHWARG</b> |

ENG. NO: 42375-1720/1753

|                   |                    |      |             |
|-------------------|--------------------|------|-------------|
| HEADER NUMBER:    | 42312-0036         |      |             |
| PIN NUMBER:       | 42663-ABB208       |      |             |
| PIN LENGTH: L     | .455 / 11.56       |      |             |
| MATING LENGTH: M  | .240 / 6.09        |      |             |
| GOLD POINT: G     | .140 / 3.56        |      |             |
| PC TAIL LENGTH: P | .125 / 3.18        |      |             |
| TIN: T            | .100 / 2.54        |      |             |
| CKTS:             | 3-36               |      |             |
| KINKS:            | NO                 |      |             |
| VOIDED CKTS:      | 3                  |      |             |
| PACKAGING:        | BULK PK-40873-0041 |      |             |
| CKTS              | ITEM NUMBER        | CKTS | ITEM NUMBER |
| 02                |                    | 20   | 42375-1737  |
| 03                | 42375-1720         | 21   | 42375-1738  |
| 04                | 42375-1721         | 22   | 42375-1739  |
| 05                | 42375-1722         | 23   | 42375-1740  |
| 06                | 42375-1723         | 24   | 42375-1741  |
| 07                | 42375-1724         | 25   | 42375-1742  |
| 08                | 42375-1725         | 26   | 42375-1743  |
| 09                | 42375-1726         | 27   | 42375-1744  |
| 10                | 42375-1727         | 28   | 42375-1745  |
| 11                | 42375-1728         | 29   | 42375-1746  |
| 12                | 42375-1729         | 30   | 42375-1747  |
| 13                | 42375-1730         | 31   | 42375-1748  |
| 14                | 42375-1731         | 32   | 42375-1749  |
| 15                | 42375-1732         | 33   | 42375-1750  |
| 16                | 42375-1733         | 34   | 42375-1751  |
| 17                | 42375-1734         | 35   | 42375-1752  |
| 18                | 42375-1735         | 36   | 42375-1753  |
| 19                | 42375-1736         |      |             |

ENG. NO: 42375-1855/1889

|                   |                    |      |             |
|-------------------|--------------------|------|-------------|
| HEADER NUMBER:    | 42312-0036         |      |             |
| PIN NUMBER:       | 42663-CJA154       |      |             |
| PIN LENGTH: L     | .700 / 17.78       |      |             |
| MATING LENGTH: M  | .488 / 12.40       |      |             |
| GOLD POINT: G     | N/A                |      |             |
| PC TAIL LENGTH: P | .122 / 3.10        |      |             |
| TIN: T            | OVERALL            |      |             |
| CKTS:             | 2-36               |      |             |
| KINKS:            | NO                 |      |             |
| VOIDED CKTS:      | NONE               |      |             |
| PACKAGING:        | BULK PK-40873-0041 |      |             |
| CKTS              | ITEM NUMBER        | CKTS | ITEM NUMBER |
| 02                | 42375-1855         | 20   | 42375-1873  |
| 03                | 42375-1856         | 21   | 42375-1874  |
| 04                | 42375-1857         | 22   | 42375-1875  |
| 05                | 42375-1858         | 23   | 42375-1876  |
| 06                | 42375-1859         | 24   | 42375-1877  |
| 07                | 42375-1860         | 25   | 42375-1878  |
| 08                | 42375-1861         | 26   | 42375-1879  |
| 09                | 42375-1862         | 27   | 42375-1880  |
| 10                | 42375-1863         | 28   | 42375-1881  |
| 11                | 42375-1864         | 29   | 42375-1882  |
| 12                | 42375-1865         | 30   | 42375-1883  |
| 13                | 42375-1866         | 31   | 42375-1884  |
| 14                | 42375-1867         | 32   | 42375-1885  |
| 15                | 42375-1868         | 33   | 42375-1886  |
| 16                | 42375-1869         | 34   | 42375-1887  |
| 17                | 42375-1870         | 35   | 42375-1888  |
| 18                | 42375-1871         | 36   | 42375-1889  |
| 19                | 42375-1872         |      |             |

REV:

**U**ECR/ECN INFORMATION:EC No.: **UCP2017-2793**DATE: **12/20/2021**TITLE:**KK 100 HEADER ASSY  
FLAT VERTICAL  
BREAKAWAY**SHEET No.**- 16 -**DOCUMENT NUMBER:**SD- 42375-001**CREATED / REVISED BY:**SS06**CHECKED BY:**ISHWARG**APPROVED BY:**ISHWARG**

|                          |             |                    |             |
|--------------------------|-------------|--------------------|-------------|
| ENG. NO: 42375-1922/1956 |             |                    |             |
| HEADER NUMBER:           |             | 42312-0036         |             |
| PIN NUMBER:              |             | 42663-AEA154       |             |
| PIN LENGTH: L            |             | .470 / 11.94       |             |
| MATING LENGTH: M         |             | .190 / 4.83        |             |
| GOLD POINT: G            |             | N/A                |             |
| PC TAIL LENGTH: P        |             | .190 / 4.83        |             |
| TIN: T                   |             | .200 / 5.08        |             |
| CKTS:                    |             | 2-36               |             |
| KINKS:                   |             | NO                 |             |
| VOIDED CKTS:             |             | NONE               |             |
| PACKAGING:               |             | BULK PK-40873-0041 |             |
| CKTS                     | ITEM NUMBER | CKTS               | ITEM NUMBER |
| 02                       | 42375-1922  | 20                 | 42375-1940  |
| 03                       | 42375-1923  | 21                 | 42375-1941  |
| 04                       | 42375-1924  | 22                 | 42375-1942  |
| 05                       | 42375-1925  | 23                 | 42375-1943  |
| 06                       | 42375-1926  | 24                 | 42375-1944  |
| 07                       | 42375-1927  | 25                 | 42375-1945  |
| 08                       | 42375-1928  | 26                 | 42375-1946  |
| 09                       | 42375-1929  | 27                 | 42375-1947  |
| 10                       | 42375-1930  | 28                 | 42375-1948  |
| 11                       | 42375-1931  | 29                 | 42375-1949  |
| 12                       | 42375-1932  | 30                 | 42375-1950  |
| 13                       | 42375-1933  | 31                 | 42375-1951  |
| 14                       | 42375-1934  | 32                 | 42375-1952  |
| 15                       | 42375-1935  | 33                 | 42375-1953  |
| 16                       | 42375-1936  | 34                 | 42375-1954  |
| 17                       | 42375-1937  | 35                 | 42375-1955  |
| 18                       | 42375-1938  | 36                 | 42375-1956  |
| 19                       | 42375-1939  |                    |             |

|                          |             |                    |             |
|--------------------------|-------------|--------------------|-------------|
| ENG. NO: 42375-2246/2275 |             |                    |             |
| HEADER NUMBER:           |             | 42312-0036         |             |
| PIN NUMBER:              |             | 42663-ABA154       |             |
| PIN LENGTH: L            |             | .455 / 11.56       |             |
| MATING LENGTH: M         |             | .240 / 6.09        |             |
| GOLD POINT: G            |             | N/A                |             |
| PC TAIL LENGTH: P        |             | .125 / 3.18        |             |
| TIN: T                   |             | OVERALL            |             |
| CKTS:                    |             | 7-36               |             |
| KINKS:                   |             | NO                 |             |
| VOIDED CKTS:             |             | 2,7                |             |
| PACKAGING:               |             | BULK PK-40873-0041 |             |
| CKTS                     | ITEM NUMBER | CKTS               | ITEM NUMBER |
| 02                       |             | 20                 | 42375-2259  |
| 03                       |             | 21                 | 42375-2260  |
| 04                       |             | 22                 | 42375-2261  |
| 05                       |             | 23                 | 42375-2262  |
| 06                       |             | 24                 | 42375-2263  |
| 07                       | 42375-2246  | 25                 | 42375-2264  |
| 08                       | 42375-2247  | 26                 | 42375-2265  |
| 09                       | 42375-2248  | 27                 | 42375-2266  |
| 10                       | 42375-2249  | 28                 | 42375-2267  |
| 11                       | 42375-2250  | 29                 | 42375-2268  |
| 12                       | 42375-2251  | 30                 | 42375-2269  |
| 13                       | 42375-2252  | 31                 | 42375-2270  |
| 14                       | 42375-2253  | 32                 | 42375-2271  |
| 15                       | 42375-2254  | 33                 | 42375-2272  |
| 16                       | 42375-2255  | 34                 | 42375-2273  |
| 17                       | 42375-2256  | 35                 | 42375-2274  |
| 18                       | 42375-2257  | 36                 | 42375-2275  |
| 19                       | 42375-2258  |                    |             |

|                         |                              |   |                     |
|-------------------------|------------------------------|---|---------------------|
| REV:                    | <u>ECR/ECN INFORMATION:</u>  | <u>TITLE:</u>   | <u>SHEET No.</u>    |
| <b>U</b>                | EC No.: <b>UCP2017-2793</b>  | <b>KK 100 HEADER ASSY<br/>FLAT VERTICAL<br/>BREAKAWAY</b> | <b>- 17 -</b>       |
|                         | DATE: <b>12/20/2021</b>      |   |                     |
| <u>DOCUMENT NUMBER:</u> | <u>CREATED / REVISED BY:</u> | <u>CHECKED BY:</u>  | <u>APPROVED BY:</u> |
| <b>SD- 42375-001</b>    | <b>SS06</b>                  | <b>ISHWARG</b>  | <b>ISHWARG</b>      |

| ENG. NO: 42375-2486/2520 |             |                    |             |
|--------------------------|-------------|--------------------|-------------|
| HEADER NUMBER:           |             | 42312-0036         |             |
| PIN NUMBER:              |             | 42663-AFB208       |             |
| PIN LENGTH: L            |             | .475 / 12.07       |             |
| MATING LENGTH: M         |             | .232 / 5.89        |             |
| GOLD POINT: G            |             | .150 / 3.81        |             |
| PC TAIL LENGTH: P        |             | .153 / 3.89        |             |
| TIN: T                   |             | .100 / 2.54        |             |
| CKTS:                    |             | 2-36               |             |
| KINKS:                   |             | NO                 |             |
| VOIDED CKTS:             |             | NONE               |             |
| PACKAGING:               |             | BULK PK-40873-0041 |             |
| CKTS                     | ITEM NUMBER | CKTS               | ITEM NUMBER |
| 02                       | 42375-2486  | 19                 | 42375-2503  |
| 03                       | 42375-2487  | 20                 | 42375-2504  |
|                          | 68300-2008  | 21                 | 42375-2505  |
| 04                       | 42375-2488  | 22                 | 42375-2506  |
| 05                       | 42375-2489  | 23                 | 42375-2507  |
| 06                       | 42375-2490  | 24                 | 42375-2508  |
| 07                       | 42375-2491  | 25                 | 42375-2509  |
| 08                       | 42375-2492  | 26                 | 42375-2510  |
| 09                       | 42375-2493  | 27                 | 42375-2511  |
| 10                       | 42375-2494  | 28                 | 42375-2512  |
| 11                       | 42375-2495  | 29                 | 42375-2513  |
| 12                       | 42375-2496  | 30                 | 42375-2514  |
| 13                       | 42375-2497  | 31                 | 42375-2515  |
| 14                       | 42375-2498  | 32                 | 42375-2516  |
| 15                       | 42375-2499  | 33                 | 42375-2517  |
| 16                       | 42375-2500  | 34                 | 42375-2518  |
| 17                       | 42375-2501  | 35                 | 42375-2519  |
| 18                       | 42375-2502  | 36                 | 42375-2520  |

| ENG. NO: 42375-2521/2555 |             |                    |             |
|--------------------------|-------------|--------------------|-------------|
| HEADER NUMBER:           |             | 42312-0036         |             |
| PIN NUMBER:              |             | 42663-AFB228       |             |
| PIN LENGTH: L            |             | .475 / 12.07       |             |
| MATING LENGTH: M         |             | .232 / 5.89        |             |
| GOLD POINT: G            |             | .150 / 3.81        |             |
| PC TAIL LENGTH: P        |             | .153 / 3.89        |             |
| TIN: T                   |             | .100 / 2.54        |             |
| CKTS:                    |             | 2-36               |             |
| KINKS:                   |             | NO                 |             |
| VOIDED CKTS:             |             | NONE               |             |
| PACKAGING:               |             | BULK PK-40873-0041 |             |
| CKTS                     | ITEM NUMBER | CKTS               | ITEM NUMBER |
| 02                       | 42375-2521  | 20                 | 42375-2539  |
| 03                       | 42375-2522  | 21                 | 42375-2540  |
| 04                       | 42375-2523  | 22                 | 42375-2541  |
| 05                       | 42375-2524  | 23                 | 42375-2542  |
| 06                       | 42375-2525  | 24                 | 42375-2543  |
| 07                       | 42375-2526  | 25                 | 42375-2544  |
| 08                       | 42375-2527  | 26                 | 42375-2545  |
| 09                       | 42375-2528  | 27                 | 42375-2546  |
| 10                       | 42375-2529  | 28                 | 42375-2547  |
| 11                       | 42375-2530  | 29                 | 42375-2548  |
| 12                       | 42375-2531  | 30                 | 42375-2549  |
| 13                       | 42375-2532  | 31                 | 42375-2550  |
| 14                       | 42375-2533  | 32                 | 42375-2551  |
| 15                       | 42375-2534  | 33                 | 42375-2552  |
| 16                       | 42375-2535  | 34                 | 42375-2553  |
| 17                       | 42375-2536  | 35                 | 42375-2554  |
| 18                       | 42375-2537  | 36                 | 42375-2555  |
| 19                       | 42375-2538  |                    |             |

|                      |      |                             |   |                |
|----------------------|------|-----------------------------|---|----------------|
| <b>U</b>             | REV: | ECR/ECN INFORMATION:        | TITLE:  | SHEET No.      |
|                      |      | EC No.: <b>UCP2017-2793</b> | <b>KK 100 HEADER ASSY<br/>FLAT VERTICAL<br/>BREAKAWAY</b> | <b>- 18 -</b>  |
|                      |      | DATE: <b>12/20/2021</b>     |   |                |
| DOCUMENT NUMBER:     |      | CREATED / REVISED BY:       | CHECKED BY:   | APPROVED BY:   |
| <b>SD- 42375-001</b> |      | <b>SS06</b>                 | <b>ISHWARG</b>  | <b>ISHWARG</b> |

|                          |             |                    |             |
|--------------------------|-------------|--------------------|-------------|
| ENG. NO: 42375-2801/2835 |             |                    |             |
| HEADER NUMBER:           |             | 42312-0036         |             |
| PIN NUMBER:              |             | 42663-HDB228       |             |
| PIN LENGTH: L            |             | 1.200 / 30.48      |             |
| MATING LENGTH: M         |             | 1.000 / 25.40      |             |
| GOLD POINT: G            |             | .200 / 5.08        |             |
| PC TAIL LENGTH: P        |             | .110 / 2.79        |             |
| TIN: T                   |             | .200 / 5.08        |             |
| CKTS:                    |             | 2-36               |             |
| KINKS:                   |             | NO                 |             |
| VOIDED CKTS:             |             | NONE               |             |
| PACKAGING:               |             | BULK PK-40873-0043 |             |
| CKTS                     | ITEM NUMBER | CKTS               | ITEM NUMBER |
| 02                       | 42375-2801  | 20                 | 42375-2819  |
| 03                       | 42375-2802  | 21                 | 42375-2820  |
| 04                       | 42375-2803  | 22                 | 42375-2821  |
| 05                       | 42375-2804  | 23                 | 42375-2822  |
| 06                       | 42375-2805  | 24                 | 42375-2823  |
| 07                       | 42375-2806  | 25                 | 42375-2824  |
| 08                       | 42375-2807  | 26                 | 42375-2825  |
| 09                       | 42375-2808  | 27                 | 42375-2826  |
| 10                       | 42375-2809  | 28                 | 42375-2827  |
| 11                       | 42375-2810  | 29                 | 42375-2828  |
| 12                       | 42375-2811  | 30                 | 42375-2829  |
| 13                       | 42375-2812  | 31                 | 42375-2830  |
| 14                       | 42375-2813  | 32                 | 42375-2831  |
| 15                       | 42375-2814  | 33                 | 42375-2832  |
| 16                       | 42375-2815  | 34                 | 42375-2833  |
| 17                       | 42375-2816  | 35                 | 42375-2834  |
| 18                       | 42375-2817  | 36                 | 42375-2835  |
| 19                       | 42375-2818  |                    |             |

|                          |             |                    |             |
|--------------------------|-------------|--------------------|-------------|
| ENG. NO: 42375-2836/2870 |             |                    |             |
| HEADER NUMBER:           |             | 42312-0036         |             |
| PIN NUMBER:              |             | 42663-EMA154       |             |
| PIN LENGTH: L            |             | .925 / 23.50       |             |
| MATING LENGTH: M         |             | .625 / 15.88       |             |
| GOLD POINT: G            |             | N/A                |             |
| PC TAIL LENGTH: P        |             | .210 / 5.33        |             |
| TIN: T                   |             | OVERALL            |             |
| CKTS:                    |             | 2-36               |             |
| KINKS:                   |             | NO                 |             |
| VOIDED CKTS:             |             | NONE               |             |
| PACKAGING:               |             | BULK PK-40873-0041 |             |
| CKTS                     | ITEM NUMBER | CKTS               | ITEM NUMBER |
| 02                       | 42375-2836  | 20                 | 42375-2854  |
| 03                       | 42375-2837  | 21                 | 42375-2855  |
| 04                       | 42375-2838  | 22                 | 42375-2856  |
| 05                       | 42375-2839  | 23                 | 42375-2857  |
| 06                       | 42375-2840  | 24                 | 42375-2858  |
| 07                       | 42375-2841  | 25                 | 42375-2859  |
| 08                       | 42375-2842  | 26                 | 42375-2860  |
| 09                       | 42375-2843  | 27                 | 42375-2861  |
| 10                       | 42375-2844  | 28                 | 42375-2862  |
| 11                       | 42375-2845  | 29                 | 42375-2863  |
| 12                       | 42375-2846  | 30                 | 42375-2864  |
| 13                       | 42375-2847  | 31                 | 42375-2865  |
| 14                       | 42375-2848  | 32                 | 42375-2866  |
| 15                       | 42375-2849  | 33                 | 42375-2867  |
| 16                       | 42375-2850  | 34                 | 42375-2868  |
| 17                       | 42375-2851  | 35                 | 42375-2869  |
| 18                       | 42375-2852  | 36                 | 42375-2870  |
| 19                       | 42375-2853  |                    |             |

|                      |      |                             |                |   |               |
|----------------------|------|-----------------------------|----------------|---|---------------|
| <b>U</b>             | REV: | ECR/ECN INFORMATION:        | TITLE:         | <b>KK 100 HEADER ASSY<br/>FLAT VERTICAL<br/>BREAKAWAY</b> | SHEET No.     |
|                      |      | EC No.: <b>UCP2017-2793</b> |                |   | <b>- 19 -</b> |
|                      |      | DATE: <b>12/20/2021</b>     |                |   |               |
| DOCUMENT NUMBER:     |      | CREATED / REVISED BY:       | CHECKED BY:    | APPROVED BY:  |               |
| <b>SD- 42375-001</b> |      | <b>SS06</b>                 | <b>ISHWARG</b> | <b>ISHWARG</b>  |               |

ENG. NO: 42375-3044/3078

|                   |                    |      |             |
|-------------------|--------------------|------|-------------|
| HEADER NUMBER:    | 42312-0036         |      |             |
| PIN NUMBER:       | 42663-KHB208       |      |             |
| PIN LENGTH: L     | 1.430 / 36.32      |      |             |
| MATING LENGTH: M  | .867 / 22.02       |      |             |
| GOLD POINT: G     | .200 / 5.08        |      |             |
| PC TAIL LENGTH: P | .473 / 12.01       |      |             |
| TIN: T            | .200 / 5.08        |      |             |
| CKTS:             | 2-36               |      |             |
| KINKS:            | NO                 |      |             |
| VOIDED CKTS:      | NONE               |      |             |
| PACKAGING:        | BULK PK-40873-0043 |      |             |
| CKTS              | ITEM NUMBER        | CKTS | ITEM NUMBER |
| 02                | 42375-3044         | 20   | 42375-3062  |
| 03                | 42375-3045         | 21   | 42375-3063  |
| 04                | 42375-3046         | 22   | 42375-3064  |
| 05                | 42375-3047         | 23   | 42375-3065  |
| 06                | 42375-3048         | 24   | 42375-3066  |
| 07                | 42375-3049         | 25   | 42375-3067  |
| 08                | 42375-3050         | 26   | 42375-3068  |
| 09                | 42375-3051         | 27   | 42375-3069  |
| 10                | 42375-3052         | 28   | 42375-3070  |
| 11                | 42375-3053         | 29   | 42375-3071  |
| 12                | 42375-3054         | 30   | 42375-3072  |
| 13                | 42375-3055         | 31   | 42375-3073  |
| 14                | 42375-3056         | 32   | 42375-3074  |
| 15                | 42375-3057         | 33   | 42375-3075  |
| 16                | 42375-3058         | 34   | 42375-3076  |
| 17                | 42375-3059         | 35   | 42375-3077  |
| 18                | 42375-3060         | 36   | 42375-3078  |
| 19                | 42375-3061         |      |             |

ENG. NO: 42375-3114/3148

|                   |                    |      |             |
|-------------------|--------------------|------|-------------|
| HEADER NUMBER:    | 42312-0036         |      |             |
| PIN NUMBER:       | 42663-BXA154       |      |             |
| PIN LENGTH: L     | .645 / 16.38       |      |             |
| MATING LENGTH: M  | .431 / 10.95       |      |             |
| GOLD POINT: G     | N/A                |      |             |
| PC TAIL LENGTH: P | .124 / 3.15        |      |             |
| TIN: T            | OVERALL            |      |             |
| CKTS:             | 2-36               |      |             |
| KINKS:            | NO                 |      |             |
| VOIDED CKTS:      | NONE               |      |             |
| PACKAGING:        | BULK PK-40873-0041 |      |             |
| CKTS              | ITEM NUMBER        | CKTS | ITEM NUMBER |
| 02                | 42375-3114         | 20   | 42375-3132  |
| 03                | 42375-3115         | 21   | 42375-3133  |
| 04                | 42375-3116         | 22   | 42375-3134  |
| 05                | 42375-3117         | 23   | 42375-3135  |
| 06                | 42375-3118         | 24   | 42375-3136  |
| 07                | 42375-3119         | 25   | 42375-3137  |
| 08                | 42375-3120         | 26   | 42375-3138  |
| 09                | 42375-3121         | 27   | 42375-3139  |
| 10                | 42375-3122         | 28   | 42375-3140  |
| 11                | 42375-3123         | 29   | 42375-3141  |
| 12                | 42375-3124         | 30   | 42375-3142  |
| 13                | 42375-3125         | 31   | 42375-3143  |
| 14                | 42375-3126         | 32   | 42375-3144  |
| 15                | 42375-3127         | 33   | 42375-3145  |
| 16                | 42375-3128         | 34   | 42375-3146  |
| 17                | 42375-3129         | 35   | 42375-3147  |
| 18                | 42375-3130         | 36   | 42375-3148  |
| 19                | 42375-3131         |      |             |

REV:

ECR/ECN INFORMATION:TITLE:SHEET No.**U**EC No.: **UCP2017-2793**DATE: **12/20/2021****KK 100 HEADER ASSY  
FLAT VERTICAL  
BREAKAWAY****- 20 -**DOCUMENT NUMBER:**SD- 42375-001**CREATED / REVISED BY:**SS06**CHECKED BY:**ISHWARG**APPROVED BY:**ISHWARG**

|                            |             |                    |             |
|----------------------------|-------------|--------------------|-------------|
| ENG. NO: 42375-3149 / 3183 |             |                    |             |
| HEADER NUMBER:             |             | 42312-0036         |             |
| PIN NUMBER:                |             | 42663-BEB208       |             |
| PIN LENGTH: L              |             | .575 / 14.61       |             |
| MATING LENGTH: M           |             | .350 / 8.89        |             |
| GOLD POINT: G              |             | .200 / 5.08        |             |
| PC TAIL LENGTH: P          |             | .135 / 3.43        |             |
| TIN: T                     |             | .200 / 5.08        |             |
| CKTS:                      |             | 2-36               |             |
| KINKS:                     |             | NO                 |             |
| VOIDED CKTS:               |             | NONE               |             |
| PACKAGING:                 |             | BULK PK-40873-0041 |             |
| CKTS                       | ITEM NUMBER | CKTS               | ITEM NUMBER |
| 02                         | 42375-3149  | 20                 | 42375-3167  |
| 03                         | 42375-3150  | 21                 | 42375-3168  |
| 04                         | 42375-3151  | 22                 | 42375-3169  |
| 05                         | 42375-3152  | 23                 | 42375-3170  |
| 06                         | 42375-3153  | 24                 | 42375-3171  |
| 07                         | 42375-3154  | 25                 | 42375-3172  |
| 08                         | 42375-3155  | 26                 | 42375-3173  |
| 09                         | 42375-3156  | 27                 | 42375-3174  |
| 10                         | 42375-3157  | 28                 | 42375-3175  |
| 11                         | 42375-3158  | 29                 | 42375-3176  |
| 12                         | 42375-3159  | 30                 | 42375-3177  |
| 13                         | 42375-3160  | 31                 | 42375-3178  |
| 14                         | 42375-3161  | 32                 | 42375-3179  |
| 15                         | 42375-3162  | 33                 | 42375-3180  |
| 16                         | 42375-3163  | 34                 | 42375-3181  |
| 17                         | 42375-3164  | 35                 | 42375-3182  |
| 18                         | 42375-3165  | 36                 | 42375-3183  |
| 19                         | 42375-3166  |                    |             |

|                            |             |                    |             |
|----------------------------|-------------|--------------------|-------------|
| ENG. NO: 42375-3184 / 3218 |             |                    |             |
| HEADER NUMBER:             |             | 42312-0036         |             |
| PIN NUMBER:                |             | 42663-GNB208       |             |
| PIN LENGTH: L              |             | 1.140 / 28.96      |             |
| MATING LENGTH: M           |             | .913 / 23.20       |             |
| GOLD POINT: G              |             | .200 / 5.08        |             |
| PC TAIL LENGTH: P          |             | .137 / 3.48        |             |
| TIN: T                     |             | .200 / 5.08        |             |
| CKTS:                      |             | 2-36               |             |
| KINKS:                     |             | NO                 |             |
| VOIDED CKTS:               |             | NONE               |             |
| PACKAGING:                 |             | BULK PK-40873-0043 |             |
| CKTS                       | ITEM NUMBER | CKTS               | ITEM NUMBER |
| 02                         | 42375-3184  | 20                 | 42375-3202  |
| 03                         | 42375-3185  | 21                 | 42375-3203  |
| 04                         | 42375-3186  | 22                 | 42375-3204  |
| 05                         | 42375-3187  | 23                 | 42375-3205  |
| 06                         | 42375-3188  | 24                 | 42375-3206  |
| 07                         | 42375-3189  | 25                 | 42375-3207  |
| 08                         | 42375-3190  | 26                 | 42375-3208  |
| 09                         | 42375-3191  | 27                 | 42375-3209  |
| 10                         | 42375-3192  | 28                 | 42375-3210  |
| 11                         | 42375-3193  | 29                 | 42375-3211  |
| 12                         | 42375-3194  | 30                 | 42375-3212  |
| 13                         | 42375-3195  | 31                 | 42375-3213  |
| 14                         | 42375-3196  | 32                 | 42375-3214  |
| 15                         | 42375-3197  | 33                 | 42375-3215  |
| 16                         | 42375-3198  | 34                 | 42375-3216  |
| 17                         | 42375-3199  | 35                 | 42375-3217  |
| 18                         | 42375-3200  | 36                 | 42375-3218  |
| 19                         | 42375-3201  |                    |             |

|                            |             |                    |             |
|----------------------------|-------------|--------------------|-------------|
| ENG. NO: 42375-3219 / 3253 |             |                    |             |
| HEADER NUMBER:             |             | 42312-0036         |             |
| PIN NUMBER:                |             | 42663-BPA154       |             |
| PIN LENGTH: L              |             | .620 / 15.75       |             |
| MATING LENGTH: M           |             | .280 / 7.11        |             |
| GOLD POINT: G              |             | NA                 |             |
| PC TAIL LENGTH: P          |             | .250 / 6.35        |             |
| TIN: T                     |             | OVERALL            |             |
| CKTS:                      |             | 2-36               |             |
| KINKS:                     |             | NO                 |             |
| VOIDED CKTS:               |             | NONE               |             |
| PACKAGING:                 |             | BULK PK-40873-0041 |             |
| CKTS                       | ITEM NUMBER | CKTS               | ITEM NUMBER |
| 02                         | 42375-3219  | 20                 | 42375-3237  |
| 03                         | 42375-3220  | 21                 | 42375-3238  |
| 04                         | 42375-3221  | 22                 | 42375-3239  |
| 05                         | 42375-3222  | 23                 | 42375-3240  |
| 06                         | 42375-3223  | 24                 | 42375-3241  |
| 07                         | 42375-3224  | 25                 | 42375-3242  |
| 08                         | 42375-3225  | 26                 | 42375-3243  |
| 09                         | 42375-3226  | 27                 | 42375-3244  |
| 10                         | 42375-3227  | 28                 | 42375-3245  |
| 11                         | 42375-3228  | 29                 | 42375-3246  |
| 12                         | 42375-3229  | 30                 | 42375-3247  |
| 13                         | 42375-3230  | 31                 | 42375-3248  |
| 14                         | 42375-3231  | 32                 | 42375-3249  |
| 15                         | 42375-3232  | 33                 | 42375-3250  |
| 16                         | 42375-3233  | 34                 | 42375-3251  |
| 17                         | 42375-3234  | 35                 | 42375-3252  |
| 18                         | 42375-3235  | 36                 | 42375-3253  |
| 19                         | 42375-3236  |                    |             |

|                         |                              |   |                     |
|-------------------------|------------------------------|---|---------------------|
| REV:                    | <u>ECR/ECN INFORMATION:</u>  | <u>TITLE:</u>   | <u>SHEET No.</u>    |
| <b>U</b>                | EC No.: <b>UCP2017-2793</b>  | <b>KK 100 HEADER ASSY<br/>FLAT VERTICAL<br/>BREAKAWAY</b> | <b>- 21 -</b>       |
|                         | DATE: <b>12/20/2021</b>      |   |                     |
| <u>DOCUMENT NUMBER:</u> | <u>CREATED / REVISED BY:</u> | <u>CHECKED BY:</u>  | <u>APPROVED BY:</u> |
| <b>SD- 42375-001</b>    | <b>SS06</b>                  | <b>ISHWARG</b>  | <b>ISHWARG</b>      |

| ENG. NO: 42375-3254 / 3288 |             |                    |             |
|----------------------------|-------------|--------------------|-------------|
| HEADER NUMBER:             |             | 42312-0036         |             |
| PIN NUMBER:                |             | 42663-DMA154       |             |
| PIN LENGTH: L              |             | .820 / 20.83       |             |
| MATING LENGTH: M           |             | .590 / 14.99       |             |
| GOLD POINT: G              |             | NA                 |             |
| PC TAIL LENGTH: P          |             | .140 / 3.56        |             |
| TIN: T                     |             | OVERALL            |             |
| CKTS:                      |             | 2-36               |             |
| KINKS:                     |             | NO                 |             |
| VOIDED CKTS:               |             | NONE               |             |
| PACKAGING:                 |             | BULK PK-40873-0041 |             |
| CKTS                       | ITEM NUMBER | CKTS               | ITEM NUMBER |
| 02                         | 42375-3254  | 20                 | 42375-3272  |
| 03                         | 42375-3255  | 21                 | 42375-3273  |
| 04                         | 42375-3256  | 22                 | 42375-3274  |
| 05                         | 42375-3257  | 23                 | 42375-3275  |
| 06                         | 42375-3258  | 24                 | 42375-3276  |
| 07                         | 42375-3259  | 25                 | 42375-3277  |
| 08                         | 42375-3260  | 26                 | 42375-3278  |
| 09                         | 42375-3261  | 27                 | 42375-3279  |
| 10                         | 42375-3262  | 28                 | 42375-3280  |
| 11                         | 42375-3263  | 29                 | 42375-3281  |
| 12                         | 42375-3264  | 30                 | 42375-3282  |
| 13                         | 42375-3265  | 31                 | 42375-3283  |
| 14                         | 42375-3266  | 32                 | 42375-3284  |
| 15                         | 42375-3267  | 33                 | 42375-3285  |
| 16                         | 42375-3268  | 34                 | 42375-3286  |
| 17                         | 42375-3269  | 35                 | 42375-3287  |
| 18                         | 42375-3270  | 36                 | 42375-3288  |
| 19                         | 42375-3271  |                    |             |

| ENG. NO: 42375-3289 / 3323 |             |                    |             |
|----------------------------|-------------|--------------------|-------------|
| HEADER NUMBER:             |             | 42312-0036         |             |
| PIN NUMBER:                |             | 42663-FNA154       |             |
| PIN LENGTH: L              |             | 1.035 / 26.29      |             |
| MATING LENGTH: M           |             | .358 / 9.09        |             |
| GOLD POINT: G              |             | NA                 |             |
| PC TAIL LENGTH: P          |             | .587 / 14.91       |             |
| TIN: T                     |             | OVERALL            |             |
| CKTS:                      |             | 2-36               |             |
| KINKS:                     |             | NO                 |             |
| VOIDED CKTS:               |             | NONE               |             |
| PACKAGING:                 |             | BULK PK-40873-0043 |             |
| CKTS                       | ITEM NUMBER | CKTS               | ITEM NUMBER |
| 02                         | 42375-3289  | 20                 | 42375-3307  |
| 03                         | 42375-3290  | 21                 | 42375-3308  |
| 04                         | 42375-3291  | 22                 | 42375-3309  |
| 05                         | 42375-3292  | 23                 | 42375-3310  |
| 06                         | 42375-3293  | 24                 | 42375-3311  |
| 07                         | 42375-3294  | 25                 | 42375-3312  |
| 08                         | 42375-3295  | 26                 | 42375-3313  |
| 09                         | 42375-3296  | 27                 | 42375-3314  |
| 10                         | 42375-3297  | 28                 | 42375-3315  |
| 11                         | 42375-3298  | 29                 | 42375-3316  |
| 12                         | 42375-3299  | 30                 | 42375-3317  |
| 13                         | 42375-3300  | 31                 | 42375-3318  |
| 14                         | 42375-3301  | 32                 | 42375-3319  |
| 15                         | 42375-3302  | 33                 | 42375-3320  |
| 16                         | 42375-3303  | 34                 | 42375-3321  |
| 17                         | 42375-3304  | 35                 | 42375-3322  |
| 18                         | 42375-3305  | 36                 | 42375-3323  |
| 19                         | 42375-3306  |                    |             |

| ENG. NO: 42375-3324 / 3358 |             |                    |             |
|----------------------------|-------------|--------------------|-------------|
| HEADER NUMBER:             |             | 42312-0036         |             |
| PIN NUMBER:                |             | 42663-CCA154       |             |
| PIN LENGTH: L              |             | .670 / 17.02       |             |
| MATING LENGTH: M           |             | .440 / 11.18       |             |
| GOLD POINT: G              |             | NA                 |             |
| PC TAIL LENGTH: P          |             | .140 / 3.56        |             |
| TIN: T                     |             | OVERALL            |             |
| CKTS:                      |             | 2-36               |             |
| KINKS:                     |             | SMES-42003         |             |
| VOIDED CKTS:               |             | NONE               |             |
| PACKAGING:                 |             | BULK PK-40873-0041 |             |
| CKTS                       | ITEM NUMBER | CKTS               | ITEM NUMBER |
| 02                         | 42375-3324  | 20                 | 42375-3342  |
| 03                         | 42375-3325  | 21                 | 42375-3343  |
| 04                         | 42375-3326  | 22                 | 42375-3344  |
| 05                         | 42375-3327  | 23                 | 42375-3345  |
| 06                         | 42375-3328  | 24                 | 42375-3346  |
| 07                         | 42375-3329  | 25                 | 42375-3347  |
| 08                         | 42375-3330  | 26                 | 42375-3348  |
| 09                         | 42375-3331  | 27                 | 42375-3349  |
| 10                         | 42375-3332  | 28                 | 42375-3350  |
| 11                         | 42375-3333  | 29                 | 42375-3351  |
| 12                         | 42375-3334  | 30                 | 42375-3352  |
| 13                         | 42375-3335  | 31                 | 42375-3353  |
| 14                         | 42375-3336  | 32                 | 42375-3354  |
| 15                         | 42375-3337  | 33                 | 42375-3355  |
| 16                         | 42375-3338  | 34                 | 42375-3356  |
| 17                         | 42375-3339  | 35                 | 42375-3357  |
| 18                         | 42375-3340  | 36                 | 42375-3358  |
| 19                         | 42375-3341  |                    |             |

|   |      |   |   |                                       |
|---|------|---|---|---------------------------------------|
| <b>U</b>  | REV: | <u>ECR/ECN INFORMATION:</u>                 | <u>TITLE:</u>   | <u>SHEET No.</u>                      |
|   |      | EC No.: <b>UCP2017-2793</b>                 | <b>KK 100 HEADER ASSY<br/>FLAT VERTICAL<br/>BREAKAWAY</b> | <b>- 22 -</b>                         |
|   |      | DATE: <b>12/20/2021</b>                     |   |                                       |
| <u>DOCUMENT NUMBER:</u><br><b>SD- 42375-001</b> |      | <u>CREATED / REVISED BY:</u><br><b>SS06</b> | <u>CHECKED BY:</u><br><b>ISHWARG</b>                      | <u>APPROVED BY:</u><br><b>ISHWARG</b> |



| ENG. NO: 42375-3359 / 3393 |             |                    |             |
|----------------------------|-------------|--------------------|-------------|
| HEADER NUMBER:             |             | 42312-0036         |             |
| PIN NUMBER:                |             | 42663-ABB228       |             |
| PIN LENGTH: L              |             | .455 / 11.56       |             |
| MATING LENGTH: M           |             | .170 / 4.32        |             |
| GOLD POINT: G              |             | .100 / 2.54        |             |
| PC TAIL LENGTH: P          |             | .195 / 4.95        |             |
| TIN: T                     |             | .100 / 2.54        |             |
| CKTS:                      |             | 2-36               |             |
| KINKS:                     |             | NO                 |             |
| VOIDED CKTS:               |             | NONE               |             |
| PACKAGING:                 |             | BULK PK-40873-0041 |             |
| CKTS                       | ITEM NUMBER | CKTS               | ITEM NUMBER |
| 02                         | 42375-3359  | 20                 | 42375-3377  |
| 03                         | 42375-3360  | 21                 | 42375-3378  |
| 04                         | 42375-3361  | 22                 | 42375-3379  |
| 05                         | 42375-3362  | 23                 | 42375-3380  |
| 06                         | 42375-3363  | 24                 | 42375-3381  |
| 07                         | 42375-3364  | 25                 | 42375-3382  |
| 08                         | 42375-3365  | 26                 | 42375-3383  |
| 09                         | 42375-3366  | 27                 | 42375-3384  |
| 10                         | 42375-3367  | 28                 | 42375-3385  |
| 11                         | 42375-3368  | 29                 | 42375-3386  |
| 12                         | 42375-3369  | 30                 | 42375-3387  |
| 13                         | 42375-3370  | 31                 | 42375-3388  |
| 14                         | 42375-3371  | 32                 | 42375-3389  |
| 15                         | 42375-3372  | 33                 | 42375-3390  |
| 16                         | 42375-3373  | 34                 | 42375-3391  |
| 17                         | 42375-3374  | 35                 | 42375-3392  |
| 18                         | 42375-3375  | 36                 | 42375-3393  |
| 19                         | 42375-3376  |                    |             |

| ENG. NO: 42375-3394 / 3428 |             |                    |             |
|----------------------------|-------------|--------------------|-------------|
| HEADER NUMBER:             |             | 42312-0036         |             |
| PIN NUMBER:                |             | 42663-EZB208       |             |
| PIN LENGTH: L              |             | .970/24.64         |             |
| MATING LENGTH: M           |             | .780/19.81         |             |
| GOLD POINT: G              |             | .200/5.08          |             |
| PC TAIL LENGTH: P          |             | .100/ 2.54         |             |
| TIN: T                     |             | .200/5.08          |             |
| CKTS:                      |             | 2-36               |             |
| KINKS:                     |             | NO                 |             |
| VOIDED CKTS:               |             | NONE               |             |
| PACKAGING:                 |             | BULK PK-40873-0043 |             |
| CKTS                       | ITEM NUMBER | CKTS               | ITEM NUMBER |
| 02                         | 42375-3394  | 20                 | 42375-3412  |
| 03                         | 42375-3395  | 21                 | 42375-3413  |
| 04                         | 42375-3396  | 22                 | 42375-3414  |
| 05                         | 42375-3397  | 23                 | 42375-3415  |
| 06                         | 42375-3398  | 24                 | 42375-3416  |
| 07                         | 42375-3399  | 25                 | 42375-3417  |
| 08                         | 42375-3400  | 26                 | 42375-3418  |
| 09                         | 42375-3401  | 27                 | 42375-3419  |
| 10                         | 42375-3402  | 28                 | 42375-3420  |
| 11                         | 42375-3403  | 29                 | 42375-3421  |
| 12                         | 42375-3404  | 30                 | 42375-3422  |
| 13                         | 42375-3405  | 31                 | 42375-3423  |
| 14                         | 42375-3406  | 32                 | 42375-3424  |
| 15                         | 42375-3407  | 33                 | 42375-3425  |
| 16                         | 42375-3408  | 34                 | 42374-3426  |
| 17                         | 42375-3409  | 35                 | 42375-3427  |
| 18                         | 42375-3410  | 36                 | 42375-3428  |
| 19                         | 42375-3411  |                    |             |

| ENG. NO: 42375-3429 / 3463 |             |                    |             |
|----------------------------|-------------|--------------------|-------------|
| HEADER NUMBER:             |             | 42312-0036         |             |
| PIN NUMBER:                |             | 42663-ARA154       |             |
| PIN LENGTH: L              |             | .520/13.21         |             |
| MATING LENGTH: M           |             | .386/9.80          |             |
| GOLD POINT: G              |             | N/A                |             |
| PC TAIL LENGTH: P          |             | .044/1.12          |             |
| TIN: T                     |             | OVERALL            |             |
| CKTS:                      |             | 2-36               |             |
| KINKS:                     |             | NO                 |             |
| VOIDED CKTS:               |             | NONE               |             |
| PACKAGING:                 |             | BULK PK-40873-0041 |             |
| CKTS                       | ITEM NUMBER | CKTS               | ITEM NUMBER |
| 02                         | 42375-3429  | 20                 | 42375-3447  |
| 03                         | 42375-3430  | 21                 | 42375-3448  |
| 04                         | 42375-3431  | 22                 | 42375-3449  |
| 05                         | 42375-3432  | 23                 | 42375-3450  |
| 06                         | 42375-3433  | 24                 | 42375-3451  |
| 07                         | 42375-3434  | 25                 | 42375-3452  |
| 08                         | 42375-3435  | 26                 | 42375-3453  |
| 09                         | 42375-3436  | 27                 | 42375-3454  |
| 10                         | 42375-3437  | 28                 | 42375-3455  |
| 11                         | 42375-3438  | 29                 | 42375-3456  |
| 12                         | 42375-3439  | 30                 | 42375-3457  |
| 13                         | 42375-3440  | 31                 | 42375-3458  |
| 14                         | 42375-3441  | 32                 | 42375-3459  |
| 15                         | 42375-3442  | 33                 | 42375-3460  |
| 16                         | 42375-3443  | 34                 | 42374-3461  |
| 17                         | 42375-3444  | 35                 | 42375-3462  |
| 18                         | 42375-3445  | 36                 | 42375-3463  |
| 19                         | 42375-3446  |                    |             |

|                      |      |                             |   |                |
|----------------------|------|-----------------------------|---|----------------|
| <b>U</b>             | REV: | ECR/ECN INFORMATION:        | TITLE:  | SHEET No.      |
|                      |      | EC No.: <b>UCP2017-2793</b> | <b>KK 100 HEADER ASSY<br/>FLAT VERTICAL<br/>BREAKAWAY</b> | <b>- 23 -</b>  |
|                      |      | DATE: <b>12/20/2021</b>     |   |                |
| DOCUMENT NUMBER:     |      | CREATED / REVISED BY:       | CHECKED BY:   | APPROVED BY:   |
| <b>SD- 42375-001</b> |      | <b>SS06</b>                 | <b>ISHWARG</b>  | <b>ISHWARG</b> |

| ENG. NO: 42375-3464 / 3498 |             |                    |             |
|----------------------------|-------------|--------------------|-------------|
| HEADER NUMBER:             |             | 42312-0036         |             |
| PIN NUMBER:                |             | 42663-CJA154       |             |
| PIN LENGTH: L              |             | .700/17.78         |             |
| MATING LENGTH: M           |             | .500/12.70         |             |
| GOLD POINT: G              |             | N/A                |             |
| PC TAIL LENGTH: P          |             | .110/2.79          |             |
| TIN: T                     |             | OVERALL            |             |
| CKTS:                      |             | 2-36               |             |
| KINKS:                     |             | NO                 |             |
| VOIDED CKTS:               |             | # 2                |             |
| PACKAGING:                 |             | BULK PK-40873-0041 |             |
| CKTS                       | ITEM NUMBER | CKTS               | ITEM NUMBER |
| 02                         | 42375-3464  | 20                 | 42375-3482  |
| 03                         | 42375-3465  | 21                 | 42375-3483  |
| 04                         | 42375-3466  | 22                 | 42375-3484  |
| 05                         | 42375-3467  | 23                 | 42375-3485  |
| 06                         | 42375-3468  | 24                 | 42375-3486  |
| 07                         | 42375-3469  | 25                 | 42375-3487  |
| 08                         | 42375-3470  | 26                 | 42375-3488  |
| 09                         | 42375-3471  | 27                 | 42375-3489  |
| 10                         | 42375-3472  | 28                 | 42375-3490  |
| 11                         | 42375-3473  | 29                 | 42375-3491  |
| 12                         | 42375-3474  | 30                 | 42375-3492  |
| 13                         | 42375-3475  | 31                 | 42375-3493  |
| 14                         | 42375-3476  | 32                 | 42375-3494  |
| 15                         | 42375-3477  | 33                 | 42375-3495  |
| 16                         | 42375-3478  | 34                 | 42375-3496  |
| 17                         | 42375-3479  | 35                 | 42375-3497  |
| 18                         | 42375-3480  | 36                 | 42375-3498  |
| 19                         | 42375-3481  |                    |             |

| ENG. NO: 42375-3499/3533 |             |                    |             |
|--------------------------|-------------|--------------------|-------------|
| HEADER NUMBER:           |             | 42312-0036         |             |
| PIN NUMBER:              |             | 42663-ETA154       |             |
| PIN LENGTH: L            |             | .950/24.13         |             |
| MATING LENGTH: M         |             | .750/19.05         |             |
| GOLD POINT: G            |             | N/A                |             |
| PC TAIL LENGTH: P        |             | .110/2.79          |             |
| TIN: T                   |             | OVERALL            |             |
| CKTS:                    |             | 2-36               |             |
| KINKS:                   |             | NO                 |             |
| VOIDED CKTS:             |             | NONE               |             |
| PACKAGING:               |             | BULK PK-40873-0043 |             |
| CKTS                     | ITEM NUMBER | CKTS               | ITEM NUMBER |
| 02                       | 42375-3499  | 20                 | 42375-3517  |
| 03                       | 42375-3500  | 21                 | 42375-3518  |
| 04                       | 42375-3501  | 22                 | 42375-3519  |
| 05                       | 42375-3502  | 23                 | 42375-3520  |
| 06                       | 42375-3503  | 24                 | 42375-3521  |
| 07                       | 42375-3504  | 25                 | 42375-3522  |
| 08                       | 42375-3505  | 26                 | 42375-3523  |
| 09                       | 42375-3506  | 27                 | 42375-3524  |
| 10                       | 42375-3507  | 28                 | 42375-3525  |
| 11                       | 42375-3508  | 29                 | 42375-3526  |
| 12                       | 42375-3509  | 30                 | 42375-3527  |
| 13                       | 42375-3510  | 31                 | 42375-3528  |
| 14                       | 42375-3511  | 32                 | 42375-3529  |
| 15                       | 42375-3512  | 33                 | 42375-3530  |
| 16                       | 42375-3513  | 34                 | 42375-3531  |
| 17                       | 42375-3514  | 35                 | 42375-3532  |
| 18                       | 42375-3515  | 36                 | 42375-3533  |
| 19                       | 42375-3516  |                    |             |

| ENG. NO: 42375-3534/3568 |             |                    |             |
|--------------------------|-------------|--------------------|-------------|
| HEADER NUMBER:           |             | 42312-0036         |             |
| PIN NUMBER:              |             | 42663-AWB208       |             |
| PIN LENGTH: L            |             | .535/13.59         |             |
| MATING LENGTH: M         |             | .235/5.97          |             |
| GOLD POINT: G            |             | .200/5.08          |             |
| PC TAIL LENGTH: P        |             | .210/5.33          |             |
| TIN: T                   |             | .100/2.54          |             |
| CKTS:                    |             | 2-36               |             |
| KINKS:                   |             | NO                 |             |
| VOIDED CKTS:             |             | NONE               |             |
| PACKAGING:               |             | BULK PK-40873-0041 |             |
| CKTS                     | ITEM NUMBER | CKTS               | ITEM NUMBER |
| 02                       | 42375-3534  | 20                 | 42375-3552  |
| 03                       | 42375-3535  | 21                 | 42375-3553  |
| 04                       | 42375-3536  | 22                 | 42375-3554  |
| 05                       | 42375-3537  | 23                 | 42375-3555  |
| 06                       | 42375-3538  | 24                 | 42375-3556  |
| 07                       | 42375-3539  | 25                 | 42375-3557  |
| 08                       | 42375-3540  | 26                 | 42375-3558  |
| 09                       | 42375-3541  | 27                 | 42375-3559  |
| 10                       | 42375-3542  | 28                 | 42375-3560  |
| 11                       | 42375-3543  | 29                 | 42375-3561  |
| 12                       | 42375-3544  | 30                 | 42375-3562  |
| 13                       | 42375-3545  | 31                 | 42375-3563  |
| 14                       | 42375-3546  | 32                 | 42375-3564  |
| 15                       | 42375-3547  | 33                 | 42375-3565  |
| 16                       | 42375-3548  | 34                 | 42375-3566  |
| 17                       | 42375-3549  | 35                 | 42375-3567  |
| 18                       | 42375-3550  | 36                 | 42375-3568  |
| 19                       | 42375-3551  |                    |             |

|   |      |   |   |                                       |
|---|------|---|---|---------------------------------------|
| <b>U</b>  | REV: | <u>ECR/ECN INFORMATION:</u>                 | <u>TITLE:</u>   | <u>SHEET No.</u>                      |
|   |      | EC No.: <b>UCP2017-2793</b>                 | <b>KK 100 HEADER ASSY<br/>FLAT VERTICAL<br/>BREAKAWAY</b> | <b>- 24 -</b>                         |
|   |      | DATE: <b>12/20/2021</b>                     |   |                                       |
| <u>DOCUMENT NUMBER:</u><br><b>SD- 42375-001</b> |      | <u>CREATED / REVISED BY:</u><br><b>SS06</b> | <u>CHECKED BY:</u><br><b>ISHWARG</b>                      | <u>APPROVED BY:</u><br><b>ISHWARG</b> |

| ENG. NO: A-42375-3569/3603 |                 |                    |      |                 |            |
|----------------------------|-----------------|--------------------|------|-----------------|------------|
| HEADER NUMBER:             |                 | 42312-0036         |      |                 |            |
| PIN NUMBER:                |                 | 42663-ABB208       |      |                 |            |
| PIN LENGTH: L              |                 | .455 / 11.56       |      |                 |            |
| MATING LENGTH: M           |                 | .240 / 6.09        |      |                 |            |
| GOLD POINT: G              |                 | .100 / 2.54        |      |                 |            |
| PC TAIL LENGTH: P          |                 | .125 / 3.18        |      |                 |            |
| TIN: T                     |                 | .100 / 2.54        |      |                 |            |
| CKTS:                      |                 | 4-36               |      |                 |            |
| KINKS:                     |                 | NO                 |      |                 |            |
| VOIDED CKTS:               |                 | 5                  |      |                 |            |
| PACKAGING:                 |                 | BULK PK-40873-0041 |      |                 |            |
| CKTS                       | MATERIAL NUMBER | ENG NUMBER         | CKTS | MATERIAL NUMBER | ENG NUMBER |
| 02                         |                 |                    | 20   | 423753587       | 42375-3587 |
| 03                         |                 |                    | 21   | 423753588       | 42375-3588 |
| 04                         |                 |                    | 22   | 423753589       | 42375-3589 |
| 05                         | 423753572       | 42375-3572         | 23   | 423753590       | 42375-3590 |
| 06                         | 423753573       | 42375-3573         | 24   | 423753591       | 42375-3591 |
| 07                         | 423753574       | 42375-3574         | 25   | 423753592       | 42375-3592 |
| 08                         | 423753575       | 42375-3575         | 26   | 423753593       | 42375-3593 |
| 09                         | 423753576       | 42375-3576         | 27   | 423753594       | 42375-3594 |
| 10                         | 423753577       | 42375-3577         | 28   | 423753595       | 42375-3595 |
| 11                         | 423753578       | 42375-3578         | 29   | 423753596       | 42375-3596 |
| 12                         | 423753579       | 42375-3579         | 30   | 423753597       | 42375-3597 |
| 13                         | 423753580       | 42375-3580         | 31   | 423753598       | 42375-3598 |
| 14                         | 423753581       | 42375-3581         | 32   | 423753599       | 42375-3599 |
| 15                         | 423753582       | 42375-3582         | 33   | 423753600       | 42375-3600 |
| 16                         | 423753583       | 42375-3583         | 34   | 423753601       | 42375-3601 |
| 17                         | 423753584       | 42375-3584         | 35   | 423753602       | 42375-3602 |
| 18                         | 423753585       | 42375-3585         | 36   | 423753603       | 42375-3603 |
| 19                         | 423753586       | 42375-3586         |      |                 |            |

| ENG. NO: A-42375-2974/3008 |                 |                    |      |                 |             |
|----------------------------|-----------------|--------------------|------|-----------------|-------------|
| HEADER NUMBER:             |                 | 42312-0036         |      |                 |             |
| PIN NUMBER:                |                 | 42663-FKB228       |      |                 |             |
| PIN LENGTH: L              |                 | 1.020 / 25.91      |      |                 |             |
| MATING LENGTH: M           |                 | .805 / 20.45       |      |                 |             |
| GOLD POINT: G              |                 | .200 / 5.08        |      |                 |             |
| PC TAIL LENGTH: P          |                 | .125 / 3.18        |      |                 |             |
| TIN: T                     |                 | .200 / 5.08        |      |                 |             |
| CKTS:                      |                 | 2-36               |      |                 |             |
| KINKS:                     |                 | NO                 |      |                 |             |
| VOIDED CKTS:               |                 | NONE               |      |                 |             |
| PACKAGING:                 |                 | BULK PK-40873-0043 |      |                 |             |
| CKTS                       | MATERIAL NUMBER | ENG NUMBER         | CKTS | MATERIAL NUMBER | ITEM NUMBER |
| 02                         |                 |                    | 20   |                 |             |
| 03                         |                 |                    | 21   |                 |             |
| 04                         |                 |                    | 22   |                 |             |
| 05                         | 423752977       | 42375-2977         | 23   |                 |             |
| 06                         |                 |                    | 24   |                 |             |
| 07                         |                 |                    | 25   |                 |             |
| 08                         |                 |                    | 26   |                 |             |
| 09                         |                 |                    | 27   |                 |             |
| 10                         |                 |                    | 28   |                 |             |
| 11                         |                 |                    | 29   |                 |             |
| 12                         |                 |                    | 30   |                 |             |
| 13                         |                 |                    | 31   |                 |             |
| 14                         |                 |                    | 32   |                 |             |
| 15                         |                 |                    | 33   |                 |             |
| 16                         |                 |                    | 34   |                 |             |
| 17                         |                 |                    | 35   |                 |             |
| 18                         |                 |                    | 36   |                 |             |
| 19                         |                 |                    |      |                 |             |

|                         |      |                              |                    |   |                  |
|-------------------------|------|------------------------------|--------------------|---|------------------|
| <b>U</b>                | REV: | <u>ECR/ECN INFORMATION:</u>  | <u>TITLE:</u>      | <b>KK 100 HEADER ASSY<br/>FLAT VERTICAL<br/>BREAKAWAY</b> | <u>SHEET No.</u> |
|                         |      | EC No.: <b>UCP2017-2793</b>  |                    |   | <b>- 25 -</b>    |
|                         |      | DATE: <b>12/20/2021</b>      |                    |   |                  |
| <u>DOCUMENT NUMBER:</u> |      | <u>CREATED / REVISED BY:</u> | <u>CHECKED BY:</u> | <u>APPROVED BY:</u>                                       |                  |
| <b>SD- 42375-001</b>    |      | <b>SS06</b>                  | <b>ISHWARG</b>     | <b>ISHWARG</b>  |                  |

| ENG. NO: A-42375-3604/3637 |                 |                    |      |                 |            |
|----------------------------|-----------------|--------------------|------|-----------------|------------|
| HEADER NUMBER:             |                 | 42312-0036         |      |                 |            |
| PIN NUMBER:                |                 | 42663-AXA154       |      |                 |            |
| PIN LENGTH: L              |                 | .540 / 13.72       |      |                 |            |
| MATING LENGTH: M           |                 | .380 / 9.65        |      |                 |            |
| GOLD POINT: G              |                 | N/A                |      |                 |            |
| PC TAIL LENGTH: P          |                 | .070 / 1.78        |      |                 |            |
| TIN: T                     |                 | OVERALL            |      |                 |            |
| CKTS:                      |                 | 3-36               |      |                 |            |
| KINKS:                     |                 | NO                 |      |                 |            |
| VOIDED CKTS:               |                 | 2                  |      |                 |            |
| PACKAGING:                 |                 | BULK PK-40873-0041 |      |                 |            |
| CKTS                       | MATERIAL NUMBER | ENG NUMBER         | CKTS | MATERIAL NUMBER | ENG NUMBER |
| 02                         |                 |                    | 20   |                 |            |
| 03                         | 42375-3604      |                    | 21   |                 |            |
| 04                         |                 |                    | 22   |                 |            |
| 05                         |                 |                    | 23   |                 |            |
| 06                         |                 |                    | 24   |                 |            |
| 07                         |                 |                    | 25   |                 |            |
| 08                         |                 |                    | 26   |                 |            |
| 09                         |                 |                    | 27   |                 |            |
| 10                         |                 |                    | 28   |                 |            |
| 11                         |                 |                    | 29   |                 |            |
| 12                         |                 |                    | 30   |                 |            |
| 13                         |                 |                    | 31   |                 |            |
| 14                         |                 |                    | 32   |                 |            |
| 15                         |                 |                    | 33   |                 |            |
| 16                         |                 |                    | 34   |                 |            |
| 17                         |                 |                    | 35   |                 |            |
| 18                         |                 |                    | 36   |                 |            |
| 19                         |                 |                    |      |                 |            |

| ENG. NO: A-42375-3638/3658 |                 |                            |      |                 |             |
|----------------------------|-----------------|----------------------------|------|-----------------|-------------|
| HEADER NUMBER:             |                 | 42312-0036                 |      |                 |             |
| PIN NUMBER:                |                 | 42663-ABA154               |      |                 |             |
| PIN LENGTH: L              |                 | .455 / 11.56               |      |                 |             |
| MATING LENGTH: M           |                 | .240 / 6.09                |      |                 |             |
| GOLD POINT: G              |                 | N/A                        |      |                 |             |
| PC TAIL LENGTH: P          |                 | .125 / 3.18                |      |                 |             |
| TIN: T                     |                 | OVERALL                    |      |                 |             |
| CKTS:                      |                 | 2-36                       |      |                 |             |
| KINKS:                     |                 | NO                         |      |                 |             |
| VOIDED CKTS:               |                 | 2, 4, 6, 8, 10, 12, 14, 16 |      |                 |             |
| PACKAGING:                 |                 | BULK PK-40873-0041         |      |                 |             |
| CKTS                       | MATERIAL NUMBER | ENG NUMBER                 | CKTS | MATERIAL NUMBER | ITEM NUMBER |
| 02                         |                 |                            | 20   |                 |             |
| 03                         |                 |                            | 21   |                 |             |
| 04                         |                 |                            | 22   |                 |             |
| 05                         |                 |                            | 23   |                 |             |
| 06                         |                 |                            | 24   |                 |             |
| 07                         |                 |                            | 25   |                 |             |
| 08                         |                 |                            | 26   |                 |             |
| 09                         |                 |                            | 27   |                 |             |
| 10                         |                 |                            | 28   |                 |             |
| 11                         |                 |                            | 29   |                 |             |
| 12                         |                 |                            | 30   |                 |             |
| 13                         |                 |                            | 31   |                 |             |
| 14                         |                 |                            | 32   |                 |             |
| 15                         |                 |                            | 33   |                 |             |
| 16                         |                 |                            | 34   |                 |             |
| 17                         | 423753639       | 42375-3639                 | 35   |                 |             |
| 18                         |                 |                            | 36   |                 |             |
| 19                         |                 |                            |      |                 |             |

|  |  |   |                                |
|--|--|---|--------------------------------|
| REV:<br><b>U</b>                         | ECR/ECN INFORMATION:<br>EC No.: <b>UCP2017-2793</b><br>DATE: <b>12/20/2021</b> | TITLE:<br><b>KK 100 HEADER ASSY<br/>FLAT VERTICAL<br/>BREAKAWAY</b> | SHEET No.<br><b>- 26 -</b>     |
| DOCUMENT NUMBER:<br><b>SD- 42375-001</b> | CREATED / REVISED BY:<br><b>SS06</b>   | CHECKED BY:<br><b>ISHWARG</b>                                       | APPROVED BY:<br><b>ISHWARG</b> |

ENG. NO: 42375-3659/3693

|                   |                    |
|-------------------|--------------------|
| HEADER NUMBER:    | 42312-0036         |
| PIN NUMBER:       | 42663-AXB208       |
| PIN LENGTH: L     | .540 / 13.72       |
| MATING LENGTH: M  | .250 / 6.35        |
| GOLD POINT: G     | .140 / 3.56        |
| PC TAIL LENGTH: P | .200 / 5.08        |
| TIN: T            | .135 / 3.43        |
| CKTS:             | 2-36               |
| KINKS:            | NO                 |
| VOIDED CKTS:      | NONE               |
| PACKAGING:        | BULK PK-40873-0041 |

| CKTS | MATERIAL NUMBER | ENG NUMBER | CKTS | MATERIAL NUMBER | ENG NUMBER |
|------|-----------------|------------|------|-----------------|------------|
| 02   | 68300-2000      | 42375-3659 | 20   |                 | 42375-3677 |
| 03   | 68300-2001      | 42375-3660 | 21   |                 | 42375-3678 |
| 04   |                 | 42375-3661 | 22   |                 | 42375-3679 |
| 05   | 68300-2006      | 42375-3662 | 23   |                 | 42375-3680 |
| 06   |                 | 42375-3663 | 24   |                 | 42375-3681 |
| 07   |                 | 42375-3664 | 25   |                 | 42375-3682 |
| 08   |                 | 42375-3665 | 26   |                 | 42375-3683 |
| 09   |                 | 42375-3666 | 27   |                 | 42375-3684 |
| 10   |                 | 42375-3667 | 28   |                 | 42375-3685 |
| 11   |                 | 42375-3668 | 29   |                 | 42375-3686 |
| 12   |                 | 42375-3669 | 30   |                 | 42375-3687 |
| 13   |                 | 42375-3670 | 31   |                 | 42375-3688 |
| 14   |                 | 42375-3671 | 32   |                 | 42375-3689 |
| 15   |                 | 42375-3672 | 33   |                 | 42375-3690 |
| 16   |                 | 42375-3673 | 34   |                 | 42375-3691 |
| 17   |                 | 42375-3674 | 35   |                 | 42375-3692 |
| 18   |                 | 42375-3675 | 36   |                 | 42375-3693 |
| 19   |                 | 42375-3676 |      |                 |            |

ENG. NO: 42375-3694/3728

|                   |                    |
|-------------------|--------------------|
| HEADER NUMBER:    | 42312-0036         |
| PIN NUMBER:       | 42663-AXB208       |
| PIN LENGTH: L     | .540 / 13.72       |
| MATING LENGTH: M  | .250 / 6.35        |
| GOLD POINT: G     | .140 / 3.56        |
| PC TAIL LENGTH: P | .200 / 5.08        |
| TIN: T            | .135 / 3.43        |
| CKTS:             | 2-36               |
| KINKS:            | NO                 |
| VOIDED CKTS:      | 5                  |
| PACKAGING:        | BULK PK-40873-0041 |

| CKTS | MATERIAL NUMBER | ENG NUMBER | CKTS | MATERIAL NUMBER | ENG NUMBER |
|------|-----------------|------------|------|-----------------|------------|
| 02   |                 | 42375-3694 | 20   |                 | 42375-3712 |
| 03   |                 | 42375-3695 | 21   |                 | 42375-3713 |
| 04   |                 | 42375-3696 | 22   |                 | 42375-3714 |
| 05   |                 | 42375-3697 | 23   |                 | 42375-3715 |
| 06   |                 | 42375-3698 | 24   |                 | 42375-3716 |
| 07   |                 | 42375-3699 | 25   |                 | 42375-3717 |
| 08   | 68300-2002      | 42375-3700 | 26   |                 | 42375-3718 |
| 09   |                 | 42375-3701 | 27   |                 | 42375-3719 |
| 10   |                 | 42375-3702 | 28   |                 | 42375-3720 |
| 11   |                 | 42375-3703 | 29   |                 | 42375-3721 |
| 12   |                 | 42375-3704 | 30   |                 | 42375-3722 |
| 13   |                 | 42375-3705 | 31   |                 | 42375-3723 |
| 14   |                 | 42375-3706 | 32   |                 | 42375-3724 |
| 15   |                 | 42375-3707 | 33   |                 | 42375-3725 |
| 16   |                 | 42375-3708 | 34   |                 | 42375-3726 |
| 17   |                 | 42375-3709 | 35   |                 | 42375-3727 |
| 18   |                 | 42375-3710 | 36   |                 | 42375-3728 |
| 19   |                 | 42375-3711 |      |                 |            |

|  |  |   |                                |
|--|--|---|--------------------------------|
| REV:<br><b>U</b>                         | ECR/ECN INFORMATION:<br>EC No.: <b>UCP2017-2793</b><br>DATE: <b>12/20/2021</b> | TITLE:<br><b>KK 100 HEADER ASSY<br/>FLAT VERTICAL<br/>BREAKAWAY</b> | SHEET No.<br><b>- 27 -</b>     |
| DOCUMENT NUMBER:<br><b>SD- 42375-001</b> | CREATED / REVISED BY:<br><b>SS06</b>   | CHECKED BY:<br><b>ISHWARG</b>                                       | APPROVED BY:<br><b>ISHWARG</b> |

ENG. NO: 42375-3729/3763

|                   |                    |
|-------------------|--------------------|
| HEADER NUMBER:    | 42312-0036         |
| PIN NUMBER:       | 42663-AFB208       |
| PIN LENGTH: L     | .475 / 12.07       |
| MATING LENGTH: M  | .232 / 5.89        |
| GOLD POINT: G     | .150 / 3.81        |
| PC TAIL LENGTH: P | .153 / 3.89        |
| TIN: T            | .150 / 3.81        |
| CKTS:             | 2-36               |
| KINKS:            | NO                 |
| VOIDED CKTS:      | 5                  |
| PACKAGING:        | BULK PK-40873-0041 |

| CKTS | MATERIAL NUMBER | ENG NUMBER | CKTS | MATERIAL NUMBER | ENG NUMBER |
|------|-----------------|------------|------|-----------------|------------|
| 02   |                 | 42375-3729 | 20   |                 | 42375-3747 |
| 03   |                 | 42375-3730 | 21   |                 | 42375-3748 |
| 04   |                 | 42375-3731 | 22   |                 | 42375-3749 |
| 05   |                 | 42375-3732 | 23   |                 | 42375-3750 |
| 06   |                 | 42375-3733 | 24   |                 | 42375-3751 |
| 07   |                 | 42375-3734 | 25   |                 | 42375-3752 |
| 08   | 68300-2007      | 42375-3735 | 26   |                 | 42375-3753 |
| 09   |                 | 42375-3736 | 27   |                 | 42375-3754 |
| 10   |                 | 42375-3737 | 28   |                 | 42375-3755 |
| 11   |                 | 42375-3738 | 29   |                 | 42375-3756 |
| 12   |                 | 42375-3739 | 30   |                 | 42375-3757 |
| 13   |                 | 42375-3740 | 31   |                 | 42375-3758 |
| 14   |                 | 42375-3741 | 32   |                 | 42375-3759 |
| 15   |                 | 42375-3742 | 33   |                 | 42375-3760 |
| 16   |                 | 42375-3743 | 34   |                 | 42375-3761 |
| 17   |                 | 42375-3744 | 35   |                 | 42375-3762 |
| 18   |                 | 42375-3745 | 36   |                 | 42375-3763 |
| 19   |                 | 42375-3746 |      |                 |            |

ENG. NO: 42375-3764/3798

| HEADER NUMBER:    | 42312-0036         |      |             |
|-------------------|--------------------|------|-------------|
| PIN NUMBER:       | 42663-ETA154       |      |             |
| PIN LENGTH: L     | .950/24.13         |      |             |
| MATING LENGTH: M  | .750/19.05         |      |             |
| GOLD POINT: G     | N/A                |      |             |
| PC TAIL LENGTH: P | .110/2.79          |      |             |
| TIN: T            | OVERALL            |      |             |
| CKTS:             | 2-36               |      |             |
| KINKS:            | NO                 |      |             |
| VOIDED CKTS:      | 2                  |      |             |
| PACKAGING:        | BULK PK-40873-0043 |      |             |
| CKTS              | ITEM NUMBER        | CKTS | ITEM NUMBER |
| 02                |                    | 20   |             |
| 03                |                    | 21   |             |
| 04                |                    | 22   |             |
| 05                |                    | 23   |             |
| 06                |                    | 24   |             |
| 07                |                    | 25   |             |
| 08                | 42375-3770         | 26   |             |
| 09                |                    | 27   |             |
| 10                |                    | 28   |             |
| 11                |                    | 29   |             |
| 12                |                    | 30   |             |
| 13                |                    | 31   |             |
| 14                |                    | 32   |             |
| 15                |                    | 33   |             |
| 16                |                    | 34   |             |
| 17                |                    | 35   |             |
| 18                |                    | 36   |             |
| 19                |                    |      |             |

REV:

**U**ECR/ECN INFORMATION:EC No.: **UCP2017-2793**DATE: **12/20/2021**TITLE:

**KK 100 HEADER ASSY  
FLAT VERTICAL  
BREAKAWAY**

SHEET No.**- 28 -**DOCUMENT NUMBER:**SD- 42375-001**CREATED / REVISED BY:**SS06**CHECKED BY:**ISHWARG**APPROVED BY:**ISHWARG**

| ENG. NO: 42375-3799/3832 |                 |                    |                 |
|--------------------------|-----------------|--------------------|-----------------|
| HEADER NUMBER:           |                 | 42312-0036         |                 |
| PIN NUMBER:              |                 | 42663-ABA154       |                 |
| PIN LENGTH: L            |                 | .455 / 11.56       |                 |
| MATING LENGTH: M         |                 | .240 / 6.09        |                 |
| GOLD POINT: G            |                 | N/A                |                 |
| PC TAIL LENGTH: P        |                 | .125 / 3.18        |                 |
| TIN: T                   |                 | OVERALL            |                 |
| CKTS:                    |                 | 3-36               |                 |
| KINKS:                   |                 | NO                 |                 |
| VOIDED CKTS:             |                 | 3                  |                 |
| PACKAGING:               |                 | BULK PK-40873-0041 |                 |
| CKTS                     | MATERIAL NUMBER | CKTS               | MATERIAL NUMBER |
| 02                       |                 | 20                 |                 |
| 03                       |                 | 21                 |                 |
| 04                       |                 | 22                 |                 |
| 05                       | 42375-3801      | 23                 |                 |
| 06                       |                 | 24                 |                 |
| 07                       |                 | 25                 |                 |
| 08                       |                 | 26                 |                 |
| 09                       |                 | 27                 |                 |
| 10                       |                 | 28                 |                 |
| 11                       |                 | 29                 |                 |
| 12                       |                 | 30                 |                 |
| 13                       |                 | 31                 |                 |
| 14                       |                 | 32                 |                 |
| 15                       |                 | 33                 |                 |
| 16                       |                 | 34                 |                 |
| 17                       |                 | 35                 |                 |
| 18                       |                 | 36                 |                 |
| 19                       |                 |                    |                 |

| ENG. NO: 42375-3733/3867 |                 |                    |                 |
|--------------------------|-----------------|--------------------|-----------------|
| HEADER NUMBER:           |                 | 42312-0036         |                 |
| PIN NUMBER:              |                 | 42663-ABB208       |                 |
| PIN LENGTH: L            |                 | .455 / 11.56       |                 |
| MATING LENGTH: M         |                 | .250 / 6.35        |                 |
| GOLD POINT: G            |                 | .100 / 2.54        |                 |
| PC TAIL LENGTH: P        |                 | .115 / 2.92        |                 |
| TIN: T                   |                 | .100 / 2.54        |                 |
| CKTS:                    |                 | 2-36               |                 |
| KINKS:                   |                 | NO                 |                 |
| VOIDED CKTS:             |                 | NONE               |                 |
| PACKAGING:               |                 | BULK PK-40873-0041 |                 |
| CKTS                     | MATERIAL NUMBER | CKTS               | MATERIAL NUMBER |
| 02                       |                 | 20                 |                 |
| 03                       |                 | 21                 |                 |
| 04                       |                 | 22                 |                 |
| 05                       | 42375-3836      | 23                 |                 |
| 06                       |                 | 24                 |                 |
| 07                       |                 | 25                 |                 |
| 08                       |                 | 26                 |                 |
| 09                       |                 | 27                 |                 |
| 10                       |                 | 28                 |                 |
| 11                       |                 | 29                 |                 |
| 12                       |                 | 30                 |                 |
| 13                       |                 | 31                 |                 |
| 14                       |                 | 32                 |                 |
| 15                       |                 | 33                 |                 |
| 16                       |                 | 34                 |                 |
| 17                       |                 | 35                 |                 |
| 18                       |                 | 36                 |                 |
| 19                       |                 |                    |                 |

| ENG. NO: 42375-3868 / 3902 |             |                    |             |
|----------------------------|-------------|--------------------|-------------|
| HEADER NUMBER:             |             | 42312-0036         |             |
| PIN NUMBER:                |             | 42663-DWA154       |             |
| PIN LENGTH: L              |             | .850 / 21.59       |             |
| MATING LENGTH: M           |             | .640 / 16.26       |             |
| GOLD POINT: G              |             | N/A                |             |
| PC TAIL LENGTH: P          |             | .120 / 3.05        |             |
| TIN: T                     |             | OVERALL            |             |
| CKTS:                      |             | 2-36               |             |
| KINKS:                     |             | NO                 |             |
| VOIDED CKTS:               |             | NONE               |             |
| PACKAGING:                 |             | BULK PK-40873-0041 |             |
| CKTS                       | ITEM NUMBER | CKTS               | ITEM NUMBER |
| 02                         |             | 20                 |             |
| 03                         |             | 21                 |             |
| 04                         | 42375-3870  | 22                 |             |
| 05                         |             | 23                 |             |
| 06                         | 42375-3872  | 24                 |             |
| 07                         |             | 25                 |             |
| 08                         |             | 26                 |             |
| 09                         |             | 27                 |             |
| 10                         |             | 28                 |             |
| 11                         |             | 29                 |             |
| 12                         |             | 30                 |             |
| 13                         |             | 31                 |             |
| 14                         |             | 32                 |             |
| 15                         |             | 33                 |             |
| 16                         |             | 34                 |             |
| 17                         |             | 35                 |             |
| 18                         |             | 36                 |             |
| 19                         |             |                    |             |

|                         |      |                              |                    |   |                  |
|-------------------------|------|------------------------------|--------------------|---|------------------|
| <b>U</b>                | REV: | <u>ECR/ECN INFORMATION:</u>  | <u>TITLE:</u>      | <b>KK 100 HEADER ASSY<br/>FLAT VERTICAL<br/>BREAKAWAY</b> | <u>SHEET No.</u> |
|                         |      | EC No.: <b>UCP2017-2793</b>  |                    |   | <b>- 29 -</b>    |
|                         |      | DATE: <b>12/20/2021</b>      |                    |   |                  |
| <u>DOCUMENT NUMBER:</u> |      | <u>CREATED / REVISED BY:</u> | <u>CHECKED BY:</u> | <u>APPROVED BY:</u>                                       |                  |
| <b>SD- 42375-001</b>    |      | <b>SS06</b>                  | <b>ISHWARG</b>     | <b>ISHWARG</b>  |                  |

| ENG. NO: 42375-3903/3932 |                 |                    |                 |
|--------------------------|-----------------|--------------------|-----------------|
| HEADER NUMBER:           |                 | 42312-0036         |                 |
| PIN NUMBER:              |                 | 42663-BSA154       |                 |
| PIN LENGTH: L            |                 | .630 / 16.00       |                 |
| MATING LENGTH: M         |                 | .421 / 10.69       |                 |
| GOLD POINT: G            |                 | N/A                |                 |
| PC TAIL LENGTH: P        |                 | .119 / 3.02        |                 |
| TIN: T                   |                 | OVERALL            |                 |
| CKTS:                    |                 | 7-36               |                 |
| KINKS:                   |                 | NO                 |                 |
| VOIDED CKTS:             |                 | 7                  |                 |
| PACKAGING:               |                 | BULK PK-40873-0041 |                 |
| CKTS                     | MATERIAL NUMBER | CKTS               | MATERIAL NUMBER |
| 02                       |                 | 20                 |                 |
| 03                       |                 | 21                 |                 |
| 04                       |                 | 22                 |                 |
| 05                       |                 | 23                 |                 |
| 06                       |                 | 24                 |                 |
| 07                       |                 | 25                 |                 |
| 08                       | 42375-3904      | 26                 |                 |
| 09                       |                 | 27                 |                 |
| 10                       |                 | 28                 |                 |
| 11                       |                 | 29                 |                 |
| 12                       |                 | 30                 |                 |
| 13                       |                 | 31                 |                 |
| 14                       |                 | 32                 |                 |
| 15                       |                 | 33                 |                 |
| 16                       |                 | 34                 |                 |
| 17                       |                 | 35                 |                 |
| 18                       |                 | 36                 |                 |
| 19                       |                 |                    |                 |

| ENG. NO: 42375-3933/3964 |                 |                    |                 |
|--------------------------|-----------------|--------------------|-----------------|
| HEADER NUMBER:           |                 | 42312-0036         |                 |
| PIN NUMBER:              |                 | 42663-BSA154       |                 |
| PIN LENGTH: L            |                 | .630 / 16.00       |                 |
| MATING LENGTH: M         |                 | .405/10.29         |                 |
| GOLD POINT: G            |                 | N/A                |                 |
| PC TAIL LENGTH: P        |                 | .135/3.43          |                 |
| TIN: T                   |                 | OVERALL            |                 |
| CKTS:                    |                 | 5-36               |                 |
| KINKS:                   |                 | SMES-42003         |                 |
| VOIDED CKTS:             |                 | 5                  |                 |
| PACKAGING:               |                 | BULK PK-40873-0041 |                 |
| CKTS                     | MATERIAL NUMBER | CKTS               | MATERIAL NUMBER |
| 02                       |                 | 20                 |                 |
| 03                       |                 | 21                 |                 |
| 04                       |                 | 22                 |                 |
| 05                       |                 | 23                 |                 |
| 06                       |                 | 24                 |                 |
| 07                       |                 | 25                 |                 |
| 08                       |                 | 26                 |                 |
| 09                       | 42375-3937      | 27                 |                 |
| 10                       |                 | 28                 |                 |
| 11                       |                 | 29                 |                 |
| 12                       |                 | 30                 |                 |
| 13                       |                 | 31                 |                 |
| 14                       |                 | 32                 |                 |
| 15                       |                 | 33                 |                 |
| 16                       |                 | 34                 |                 |
| 17                       |                 | 35                 |                 |
| 18                       |                 | 36                 |                 |
| 19                       |                 |                    |                 |

| ENG. NO: 42375-3965/3995 |                 |                    |                 |
|--------------------------|-----------------|--------------------|-----------------|
| HEADER NUMBER:           |                 | 42312-0036         |                 |
| PIN NUMBER:              |                 | 42663-BSA154       |                 |
| PIN LENGTH: L            |                 | .630 / 16.00       |                 |
| MATING LENGTH: M         |                 | .405/10.29         |                 |
| GOLD POINT: G            |                 | N/A                |                 |
| PC TAIL LENGTH: P        |                 | .135/3.43          |                 |
| TIN: T                   |                 | OVERALL            |                 |
| CKTS:                    |                 | 6-36               |                 |
| KINKS:                   |                 | SMES-42003         |                 |
| VOIDED CKTS:             |                 | 4, 5, 6            |                 |
| PACKAGING:               |                 | BULK PK-40873-0041 |                 |
| CKTS                     | MATERIAL NUMBER | CKTS               | MATERIAL NUMBER |
| 02                       |                 | 20                 |                 |
| 03                       |                 | 21                 |                 |
| 04                       |                 | 22                 |                 |
| 05                       |                 | 23                 |                 |
| 06                       |                 | 24                 |                 |
| 07                       |                 | 25                 |                 |
| 08                       |                 | 26                 |                 |
| 09                       | 42375-3968      | 27                 |                 |
| 10                       |                 | 28                 |                 |
| 11                       |                 | 29                 |                 |
| 12                       |                 | 30                 |                 |
| 13                       |                 | 31                 |                 |
| 14                       |                 | 32                 |                 |
| 15                       |                 | 33                 |                 |
| 16                       |                 | 34                 |                 |
| 17                       |                 | 35                 |                 |
| 18                       |                 | 36                 |                 |
| 19                       |                 |                    |                 |

|   |      |   |   |                                       |
|---|------|---|---|---------------------------------------|
| <b>U</b>  | REV: | <u>ECR/ECN INFORMATION:</u>                 | <u>TITLE:</u>   | <u>SHEET No.</u>                      |
|   |      | EC No.: <b>UCP2017-2793</b>                 | <b>KK 100 HEADER ASSY<br/>FLAT VERTICAL<br/>BREAKAWAY</b> | <b>- 30 -</b>                         |
|   |      | DATE: <b>12/20/2021</b>                     |   |                                       |
| <u>DOCUMENT NUMBER:</u><br><b>SD- 42375-001</b> |      | <u>CREATED / REVISED BY:</u><br><b>SS06</b> | <u>CHECKED BY:</u><br><b>ISHWARG</b>                      | <u>APPROVED BY:</u><br><b>ISHWARG</b> |



|                            |             |                    |             |
|----------------------------|-------------|--------------------|-------------|
| ENG. NO: A-42375-3996/4030 |             |                    |             |
| HEADER NUMBER:             |             | 42312-0036         |             |
| PIN NUMBER:                |             | 42663-AXA154       |             |
| PIN LENGTH: L              |             | .540 / 13.72       |             |
| MATING LENGTH: M           |             | .390 / 9.91        |             |
| GOLD POINT: G              |             | N/A                |             |
| PC TAIL LENGTH: P          |             | .060 / 1.52        |             |
| TIN: T                     |             | OVERALL            |             |
| CKTS:                      |             | 2-36               |             |
| KINKS:                     |             | NO                 |             |
| VOIDED CKTS:               |             | NONE               |             |
| PACKAGING:                 |             | BULK PK-40873-0041 |             |
| CKTS                       | ITEM NUMBER | CKTS               | ITEM NUMBER |
| 02                         |             | 20                 |             |
| 03                         |             | 21                 |             |
| 04                         |             | 22                 |             |
| 05                         |             | 23                 |             |
| 06                         | 42375-4000  | 24                 |             |
| 07                         | 42375-4001  | 25                 |             |
| 08                         |             | 26                 |             |
| 09                         |             | 27                 |             |
| 10                         |             | 28                 |             |
| 11                         |             | 29                 |             |
| 12                         |             | 30                 |             |
| 13                         |             | 31                 |             |
| 14                         |             | 32                 |             |
| 15                         |             | 33                 |             |
| 16                         |             | 34                 |             |
| 17                         |             | 35                 |             |
| 18                         |             | 36                 |             |
| 19                         |             |                    |             |

|                          |                 |                    |                 |
|--------------------------|-----------------|--------------------|-----------------|
| ENG. NO: 42375-4031/4059 |                 |                    |                 |
| HEADER NUMBER:           |                 | 42312-0036         |                 |
| PIN NUMBER:              |                 | 42663-ABA154       |                 |
| PIN LENGTH: L            |                 | .455 / 11.56       |                 |
| MATING LENGTH: M         |                 | .240 / 6.09        |                 |
| GOLD POINT: G            |                 | N/A                |                 |
| PC TAIL LENGTH: P        |                 | .125 / 3.18        |                 |
| TIN: T                   |                 | OVERALL            |                 |
| CKTS:                    |                 | 8-36               |                 |
| KINKS:                   |                 | NO                 |                 |
| VOIDED CKTS:             |                 | 2, 4, 6, 8         |                 |
| PACKAGING:               |                 | BULK PK-40873-0041 |                 |
| CKTS                     | MATERIAL NUMBER | CKTS               | MATERIAL NUMBER |
| 02                       |                 | 20                 |                 |
| 03                       |                 | 21                 |                 |
| 04                       |                 | 22                 |                 |
| 05                       |                 | 23                 |                 |
| 06                       |                 | 24                 |                 |
| 07                       |                 | 25                 |                 |
| 08                       |                 | 26                 |                 |
| 09                       | 42375-4032      | 27                 |                 |
| 10                       |                 | 28                 |                 |
| 11                       |                 | 29                 |                 |
| 12                       |                 | 30                 |                 |
| 13                       |                 | 31                 |                 |
| 14                       |                 | 32                 |                 |
| 15                       |                 | 33                 |                 |
| 16                       |                 | 34                 |                 |
| 17                       |                 | 35                 |                 |
| 18                       |                 | 36                 |                 |
| 19                       |                 |                    |                 |

|                            |                 |                    |                 |
|----------------------------|-----------------|--------------------|-----------------|
| ENG. NO: 42375-4060 / 4094 |                 |                    |                 |
| HEADER NUMBER:             |                 | 42312-0036         |                 |
| PIN NUMBER:                |                 | 42663-CGA154       |                 |
| PIN LENGTH: L              |                 | .690 / 17.53       |                 |
| MATING LENGTH: M           |                 | .521 / 13.23       |                 |
| GOLD POINT: G              |                 | N/A                |                 |
| PC TAIL LENGTH: P          |                 | .079 / 2.01        |                 |
| TIN: T                     |                 | OVERALL            |                 |
| CKTS:                      |                 | 2-36               |                 |
| KINKS:                     |                 | NO                 |                 |
| VOIDED CKTS:               |                 | NONE               |                 |
| PACKAGING:                 |                 | BULK PK-40873-0041 |                 |
| CKTS                       | MATERIAL NUMBER | CKTS               | MATERIAL NUMBER |
| 02                         |                 | 20                 |                 |
| 03                         |                 | 21                 |                 |
| 04                         |                 | 22                 |                 |
| 05                         |                 | 23                 |                 |
| 06                         | 42375-4064      | 24                 |                 |
| 07                         |                 | 25                 |                 |
| 08                         |                 | 26                 |                 |
| 09                         |                 | 27                 |                 |
| 10                         |                 | 28                 |                 |
| 11                         |                 | 29                 |                 |
| 12                         |                 | 30                 |                 |
| 13                         |                 | 31                 |                 |
| 14                         |                 | 32                 |                 |
| 15                         |                 | 33                 |                 |
| 16                         |                 | 34                 |                 |
| 17                         |                 | 35                 |                 |
| 18                         |                 | 36                 |                 |
| 19                         |                 |                    |                 |

|   |      |   |   |                                       |
|---|------|---|---|---------------------------------------|
| <b>U</b>  | REV: | <u>ECR/ECN INFORMATION:</u>                 | <u>TITLE:</u>   | <u>SHEET No.</u>                      |
|   |      | EC No.: <b>UCP2017-2793</b>                 | <b>KK 100 HEADER ASSY<br/>FLAT VERTICAL<br/>BREAKAWAY</b> | <b>- 31 -</b>                         |
|   |      | DATE: <b>12/20/2021</b>                     |   |                                       |
| <u>DOCUMENT NUMBER:</u><br><b>SD- 42375-001</b> |      | <u>CREATED / REVISED BY:</u><br><b>SS06</b> | <u>CHECKED BY:</u><br><b>ISHWARG</b>                      | <u>APPROVED BY:</u><br><b>ISHWARG</b> |

| ENG. NO: A-42375-4095/4129 |             |                    |             |
|----------------------------|-------------|--------------------|-------------|
| HEADER NUMBER:             |             | 42312-0036         |             |
| PIN NUMBER:                |             | 42663-DEB228       |             |
| PIN LENGTH: L              |             | .785 / 19.94       |             |
| MATING LENGTH: M           |             | .470 / 11.94       |             |
| GOLD POINT: G              |             | .250 / 6.35        |             |
| PC TAIL LENGTH: P          |             | .225 / 5.72        |             |
| TIN: T                     |             | .200 / 5.08        |             |
| CKTS:                      |             | 2-36               |             |
| KINKS:                     |             | NO                 |             |
| VOIDED CKTS:               |             | NONE               |             |
| PACKAGING:                 |             | BULK PK-40873-0041 |             |
| CKTS                       | ITEM NUMBER | CKTS               | ITEM NUMBER |
| 02                         |             | 20                 |             |
| 03                         |             | 21                 |             |
| 04                         |             | 22                 |             |
| 05                         |             | 23                 |             |
| 06                         |             | 24                 |             |
| 07                         |             | 25                 |             |
| 08                         |             | 26                 |             |
| 09                         |             | 27                 |             |
| 10                         | 42375-4103  | 28                 |             |
| 11                         |             | 29                 |             |
| 12                         |             | 30                 |             |
| 13                         |             | 31                 |             |
| 14                         |             | 32                 |             |
| 15                         |             | 33                 |             |
| 16                         |             | 34                 |             |
| 17                         |             | 35                 |             |
| 18                         | 42375-4111  | 36                 |             |
| 19                         |             |                    |             |

| ENG. NO: A-42375-4130/4161 |             |                    |             |
|----------------------------|-------------|--------------------|-------------|
| HEADER NUMBER:             |             | 42312-0036         |             |
| PIN NUMBER:                |             | 42663-ATA154       |             |
| PIN LENGTH: L              |             | .530/13.46         |             |
| MATING LENGTH: M           |             | .320/8.13          |             |
| GOLD POINT: G              |             | N/A                |             |
| PC TAIL LENGTH: P          |             | .120/3.05          |             |
| TIN: T                     |             | OVERALL            |             |
| CKTS:                      |             | 5-36               |             |
| KINKS:                     |             | SMES-42003         |             |
| VOIDED CKTS:               |             | 2, 3, 4            |             |
| PACKAGING:                 |             | BULK PK-40873-0041 |             |
| CKTS                       | ITEM NUMBER | CKTS               | ITEM NUMBER |
|                            |             | 20                 |             |
|                            |             | 21                 |             |
|                            |             | 22                 |             |
| 05                         | 42375-4130  | 23                 |             |
| 06                         |             | 24                 |             |
| 07                         |             | 25                 |             |
| 08                         |             | 26                 |             |
| 09                         |             | 27                 |             |
| 10                         |             | 28                 |             |
| 11                         |             | 29                 |             |
| 12                         |             | 30                 |             |
| 13                         |             | 31                 |             |
| 14                         |             | 32                 |             |
| 15                         |             | 33                 |             |
| 16                         |             | 34                 |             |
| 17                         |             | 35                 |             |
| 18                         |             | 36                 |             |
| 19                         |             |                    |             |

| ENG. NO: 42375-4162/4196 |                 |                    |                 |
|--------------------------|-----------------|--------------------|-----------------|
| HEADER NUMBER:           |                 | 42312-0036         |                 |
| PIN NUMBER:              |                 | 42663-BSC228       |                 |
| PIN LENGTH: L            |                 | .630/16.00         |                 |
| MATING LENGTH: M         |                 | .400/10.16         |                 |
| GOLD POINT: G            |                 | .345/8.76          |                 |
| PC TAIL LENGTH: P        |                 | .140/3.56          |                 |
| TIN: T                   |                 | .100/2.54          |                 |
| CKTS:                    |                 | 2-36               |                 |
| KINKS:                   |                 | NO                 |                 |
| VOIDED CKTS:             |                 | NONE               |                 |
| PACKAGING:               |                 | BULK PK-40873-0041 |                 |
| CKTS                     | MATERIAL NUMBER | CKTS               | MATERIAL NUMBER |
| 02                       |                 | 20                 |                 |
| 03                       |                 | 21                 |                 |
| 04                       | 42375-4164      | 22                 |                 |
| 05                       | 42375-4165      | 23                 |                 |
| 06                       |                 | 24                 |                 |
| 07                       |                 | 25                 |                 |
| 08                       |                 | 26                 |                 |
| 09                       |                 | 27                 |                 |
| 10                       | 42375-4170      | 28                 |                 |
| 11                       |                 | 29                 |                 |
| 12                       |                 | 30                 |                 |
| 13                       |                 | 31                 |                 |
| 14                       |                 | 32                 |                 |
| 15                       |                 | 33                 |                 |
| 16                       |                 | 34                 |                 |
| 17                       |                 | 35                 |                 |
| 18                       |                 | 36                 |                 |
| 19                       |                 |                    |                 |

|   |      |   |   |                                       |
|---|------|---|---|---------------------------------------|
| <b>U</b>  | REV: | <u>ECR/ECN INFORMATION:</u>                 | <u>TITLE:</u>   | <u>SHEET No.</u>                      |
|   |      | EC No.: <b>UCP2017-2793</b>                 | <b>KK 100 HEADER ASSY<br/>FLAT VERTICAL<br/>BREAKAWAY</b> | <b>- 32 -</b>                         |
|   |      | DATE: <b>12/20/2021</b>                     |   |                                       |
| <u>DOCUMENT NUMBER:</u><br><b>SD- 42375-001</b> |      | <u>CREATED / REVISED BY:</u><br><b>SS06</b> | <u>CHECKED BY:</u><br><b>ISHWARG</b>                      | <u>APPROVED BY:</u><br><b>ISHWARG</b> |

| ENG. NO: A-42375-1622 |                 |                    |                 |
|-----------------------|-----------------|--------------------|-----------------|
| HEADER NUMBER:        |                 | 42312-0036         |                 |
| PIN NUMBER:           |                 | 42663-AYB208       |                 |
| PIN LENGTH: L         |                 | .545 / 13.84       |                 |
| MATING LENGTH: M      |                 | .320 / 8.13        |                 |
| GOLD POINT: G         |                 | .140 / 3.56        |                 |
| PC TAIL LENGTH: P     |                 | .135 / 3.43        |                 |
| TIN: T                |                 | .135 / 3.43        |                 |
| CKTS:                 |                 | 2-36               |                 |
| KINKS:                |                 | SMES-42003         |                 |
| VOIDED CKTS:          |                 | 3                  |                 |
| PACKAGING:            |                 | BULK PK-40873-0041 |                 |
| CKTS                  | MATERIAL NUMBER | CKTS               | MATERIAL NUMBER |
| 02                    |                 | 20                 |                 |
| 03                    |                 | 21                 |                 |
| 04                    |                 | 22                 |                 |
| 05                    |                 | 23                 |                 |
| 06                    |                 | 24                 |                 |
| 07                    |                 | 25                 |                 |
| 08                    |                 | 26                 |                 |
| 09                    | 42375-1622      | 27                 |                 |
| 10                    |                 | 28                 |                 |
| 11                    |                 | 29                 |                 |
| 12                    |                 | 30                 |                 |
| 13                    |                 | 31                 |                 |
| 14                    |                 | 32                 |                 |
| 15                    |                 | 33                 |                 |
| 16                    |                 | 34                 |                 |
| 17                    |                 | 35                 |                 |
| 18                    |                 | 36                 |                 |
| 19                    |                 |                    |                 |

| ENG. NO: A-42375-4199 |                 |                    |                 |
|-----------------------|-----------------|--------------------|-----------------|
| HEADER NUMBER:        |                 | 42312-0036         |                 |
| PIN NUMBER:           |                 | 42663-ARB228       |                 |
| PIN LENGTH: L         |                 | .520 / 13.21       |                 |
| MATING LENGTH: M      |                 | .230 / 5.84        |                 |
| GOLD POINT: G         |                 | .140 / 3.56        |                 |
| PC TAIL LENGTH: P     |                 | .200 / 5.08        |                 |
| TIN: T                |                 | .135 / 3.43        |                 |
| CKTS:                 |                 | 2-36               |                 |
| KINKS:                |                 | NO                 |                 |
| VOIDED CKTS:          |                 | NONE               |                 |
| PACKAGING:            |                 | BULK PK-40873-0041 |                 |
| CKTS                  | MATERIAL NUMBER | CKTS               | MATERIAL NUMBER |
| 02                    | 42375-4199      | 20                 |                 |
| 03                    |                 | 21                 |                 |
| 04                    |                 | 22                 |                 |
| 05                    |                 | 23                 |                 |
| 06                    |                 | 24                 |                 |
| 07                    |                 | 25                 |                 |
| 08                    |                 | 26                 |                 |
| 09                    |                 | 27                 |                 |
| 10                    |                 | 28                 |                 |
| 11                    |                 | 29                 |                 |
| 12                    |                 | 30                 |                 |
| 13                    |                 | 31                 |                 |
| 14                    |                 | 32                 |                 |
| 15                    |                 | 33                 |                 |
| 16                    |                 | 34                 |                 |
| 17                    |                 | 35                 |                 |
| 18                    |                 | 36                 |                 |
| 19                    |                 |                    |                 |

| ENG. NO: A-42375-4200 |                 |                    |                 |
|-----------------------|-----------------|--------------------|-----------------|
| HEADER NUMBER:        |                 | 42312-0036         |                 |
| PIN NUMBER:           |                 | 42663-ADB208       |                 |
| PIN LENGTH: L         |                 | .465 / 11.81       |                 |
| MATING LENGTH: M      |                 | .240 / 6.09        |                 |
| GOLD POINT: G         |                 | .100 / 2.54        |                 |
| PC TAIL LENGTH: P     |                 | .135 / 3.43        |                 |
| TIN: T                |                 | .100 / 2.54        |                 |
| CKTS:                 |                 | 2-36               |                 |
| KINKS:                |                 | SMES-42003         |                 |
| VOIDED CKTS:          |                 | 3, 4               |                 |
| PACKAGING:            |                 | BULK PK-40873-0041 |                 |
| CKTS                  | MATERIAL NUMBER | CKTS               | MATERIAL NUMBER |
| 02                    |                 | 20                 |                 |
| 03                    |                 | 21                 |                 |
| 04                    |                 | 22                 |                 |
| 05                    | 42375-4200      | 23                 |                 |
| 06                    |                 | 24                 |                 |
| 07                    |                 | 25                 |                 |
| 08                    |                 | 26                 |                 |
| 09                    |                 | 27                 |                 |
| 10                    |                 | 28                 |                 |
| 11                    |                 | 29                 |                 |
| 12                    |                 | 30                 |                 |
| 13                    |                 | 31                 |                 |
| 14                    |                 | 32                 |                 |
| 15                    |                 | 33                 |                 |
| 16                    |                 | 34                 |                 |
| 17                    |                 | 35                 |                 |
| 18                    |                 | 36                 |                 |
| 19                    |                 |                    |                 |

|                         |      |                              |   |                     |
|-------------------------|------|------------------------------|---|---------------------|
| <b>U</b>                | REV: | <u>ECR/ECN INFORMATION:</u>  | <u>TITLE:</u>   | <u>SHEET No.</u>    |
|                         |      | EC No.: <b>UCP2017-2793</b>  | <b>KK 100 HEADER ASSY<br/>FLAT VERTICAL<br/>BREAKAWAY</b> | <b>- 33 -</b>       |
|                         |      | DATE: <b>12/20/2021</b>      |   |                     |
| <u>DOCUMENT NUMBER:</u> |      | <u>CREATED / REVISED BY:</u> | <u>CHECKED BY:</u>  | <u>APPROVED BY:</u> |
| <b>SD- 42375-001</b>    |      | <b>SS06</b>                  | <b>ISHWARG</b>  | <b>ISHWARG</b>      |

| ENG. NO: 42375-4236 |             |                    |             |
|---------------------|-------------|--------------------|-------------|
| HEADER NUMBER:      |             | 42312-0036         |             |
| PIN NUMBER:         |             | 42663-CCA118       |             |
| PIN LENGTH: L       |             | .670 / 17.02       |             |
| MATING LENGTH: M    |             | .440 / 11.18       |             |
| GOLD POINT: G       |             | NA                 |             |
| PC TAIL LENGTH: P   |             | .140 / 3.56        |             |
| TIN: T              |             | OVERALL            |             |
| CKTS:               |             | 2-36               |             |
| KINKS:              |             | SMES-42003         |             |
| VOIDED CKTS:        |             | NONE               |             |
| PACKAGING:          |             | BULK PK-40873-0041 |             |
| CKTS                | ITEM NUMBER | CKTS               | ITEM NUMBER |
| 02                  |             | 20                 |             |
| 03                  |             | 21                 |             |
| 04                  |             | 22                 |             |
| 05                  |             | 23                 |             |
| 06                  | 42375-4236  | 24                 |             |
| 07                  |             | 25                 |             |
| 08                  |             | 26                 |             |
| 09                  |             | 27                 |             |
| 10                  |             | 28                 |             |
| 11                  |             | 29                 |             |
| 12                  |             | 30                 |             |
| 13                  |             | 31                 |             |
| 14                  |             | 32                 |             |
| 15                  |             | 33                 |             |
| 16                  |             | 34                 |             |
| 17                  |             | 35                 |             |
| 18                  |             | 36                 |             |
| 19                  |             |                    |             |

| ENG. NO: 42375-4305 |                 |                    |                 |
|---------------------|-----------------|--------------------|-----------------|
| HEADER NUMBER:      |                 | 42312-0036         |                 |
| PIN NUMBER:         |                 | 42663-BDA154       |                 |
| PIN LENGTH: L       |                 | .570 / 14.48       |                 |
| MATING LENGTH: M    |                 | .339 / 8.61        |                 |
| GOLD POINT: G       |                 | N/A                |                 |
| PC TAIL LENGTH: P   |                 | .141 / 3.58        |                 |
| TIN: T              |                 | OVERALL            |                 |
| CKTS:               |                 | 2-36               |                 |
| KINKS:              |                 | NO                 |                 |
| VOIDED CKTS:        |                 | NONE               |                 |
| PACKAGING:          |                 | BULK PK-40873-0041 |                 |
| CKTS                | MATERIAL NUMBER | CKTS               | MATERIAL NUMBER |
| 02                  |                 | 20                 |                 |
| 03                  |                 | 21                 |                 |
| 04                  |                 | 22                 |                 |
| 05                  | 42375-4305      | 23                 |                 |
| 06                  |                 | 24                 |                 |
| 07                  |                 | 25                 |                 |
| 08                  |                 | 26                 |                 |
| 09                  |                 | 27                 |                 |
| 10                  |                 | 28                 |                 |
| 11                  |                 | 29                 |                 |
| 12                  |                 | 30                 |                 |
| 13                  |                 | 31                 |                 |
| 14                  |                 | 32                 |                 |
| 15                  |                 | 33                 |                 |
| 16                  |                 | 34                 |                 |
| 17                  |                 | 35                 |                 |
| 18                  |                 | 36                 |                 |
| 19                  |                 |                    |                 |

| ENG. NO: 42375-4338/4341 |                 |                    |                 |
|--------------------------|-----------------|--------------------|-----------------|
| HEADER NUMBER:           |                 | 42312-0036         |                 |
| PIN NUMBER:              |                 | 42663-BGA154       |                 |
| PIN LENGTH: L            |                 | .585 / 14.86       |                 |
| MATING LENGTH: M         |                 | .398 / 10.11       |                 |
| GOLD POINT: G            |                 | N/A                |                 |
| PC TAIL LENGTH: P        |                 | .097 / 2.46        |                 |
| TIN: T                   |                 | OVERALL            |                 |
| CKTS:                    |                 | 2-36               |                 |
| KINKS:                   |                 | NO                 |                 |
| VOIDED CKTS:             |                 | NONE               |                 |
| PACKAGING:               |                 | BULK PK-40873-0041 |                 |
| CKTS                     | MATERIAL NUMBER | CKTS               | MATERIAL NUMBER |
| 02                       |                 | 20                 |                 |
| 03                       | 42375-4338      | 21                 |                 |
| 04                       |                 | 22                 |                 |
| 05                       |                 | 23                 |                 |
| 06                       | 42375-4341      | 24                 |                 |
| 07                       |                 | 25                 |                 |
| 08                       |                 | 26                 |                 |
| 09                       |                 | 27                 |                 |
| 10                       |                 | 28                 |                 |
| 11                       |                 | 29                 |                 |
| 12                       |                 | 30                 |                 |
| 13                       |                 | 31                 |                 |
| 14                       |                 | 32                 |                 |
| 15                       |                 | 33                 |                 |
| 16                       |                 | 34                 |                 |
| 17                       |                 | 35                 |                 |
| 18                       |                 | 36                 |                 |
| 19                       |                 |                    |                 |

|                         |      |                              |   |                     |
|-------------------------|------|------------------------------|---|---------------------|
| <b>U</b>                | REV: | <u>ECR/ECN INFORMATION:</u>  | <u>TITLE:</u>   | <u>SHEET No.</u>    |
|                         |      | EC No.: <b>UCP2017-2793</b>  | <b>KK 100 HEADER ASSY<br/>FLAT VERTICAL<br/>BREAKAWAY</b> | <b>- 34 -</b>       |
|                         |      | DATE: <b>12/20/2021</b>      |   |                     |
| <u>DOCUMENT NUMBER:</u> |      | <u>CREATED / REVISED BY:</u> | <u>CHECKED BY:</u>  | <u>APPROVED BY:</u> |
| <b>SD- 42375-001</b>    |      | <b>SS06</b>                  | <b>ISHWARG</b>  | <b>ISHWARG</b>      |

ENG. NO: 42375-4413

|                   |                    |      |             |
|-------------------|--------------------|------|-------------|
| HEADER NUMBER:    | 42312-0036         |      |             |
| PIN NUMBER:       | 42663-ABB208       |      |             |
| PIN LENGTH: L     | .455 / 11.56       |      |             |
| MATING LENGTH: M  | .240 / 6.09        |      |             |
| GOLD POINT: G     | .100 / 2.54        |      |             |
| PC TAIL LENGTH: P | .125 / 3.18        |      |             |
| TIN: T            | .100 / 2.54        |      |             |
| CKTS:             | 6-36               |      |             |
| KINKS:            | NO                 |      |             |
| VOIDED CKTS:      | 2, 4, 6            |      |             |
| PACKAGING:        | BULK PK-40873-0041 |      |             |
| CKTS              | ITEM NUMBER        | CKTS | ITEM NUMBER |
| 02                |                    | 20   |             |
| 03                |                    | 21   |             |
| 04                |                    | 22   |             |
| 05                |                    | 23   |             |
| 06                |                    | 24   |             |
| 07                | 42375-4413         | 25   |             |
| 08                |                    | 26   |             |
| 09                |                    | 27   |             |
| 10                |                    | 28   |             |
| 11                |                    | 29   |             |
| 12                |                    | 30   |             |
| 13                |                    | 31   |             |
| 14                |                    | 32   |             |
| 15                |                    | 33   |             |
| 16                |                    | 34   |             |
| 17                |                    | 35   |             |
| 18                |                    | 36   |             |
| 19                |                    |      |             |

ENG. NO: 42375-4445

|                   |                    |      |                 |
|-------------------|--------------------|------|-----------------|
| HEADER NUMBER:    | 42312-0036         |      |                 |
| PIN NUMBER:       | 42663-0364         |      |                 |
| PLATING:          | 228                |      |                 |
| PIN LENGTH: L     | .590 / 14.99       |      |                 |
| MATING LENGTH: M  | .380 / 9.65        |      |                 |
| GOLD POINT: G     | .200 / 5.08        |      |                 |
| PC TAIL LENGTH: P | .120 / 3.05        |      |                 |
| TIN: T            | .135 / 3.43        |      |                 |
| CKTS:             | 2-36               |      |                 |
| KINKS:            | NO                 |      |                 |
| VOIDED CKTS:      | NONE               |      |                 |
| PACKAGING:        | BULK PK-40873-0041 |      |                 |
| CKTS              | MATERIAL NUMBER    | CKTS | MATERIAL NUMBER |
| 02                |                    | 20   |                 |
| 03                |                    | 21   |                 |
| 04                | 42375-4445         | 22   |                 |
| 05                |                    | 23   |                 |
| 06                |                    | 24   |                 |
| 07                |                    | 25   |                 |
| 08                |                    | 26   |                 |
| 09                |                    | 27   |                 |
| 10                |                    | 28   |                 |
| 11                |                    | 29   |                 |
| 12                |                    | 30   |                 |
| 13                |                    | 31   |                 |
| 14                |                    | 32   |                 |
| 15                |                    | 33   |                 |
| 16                |                    | 34   |                 |
| 17                |                    | 35   |                 |
| 18                |                    | 36   |                 |
| 19                |                    |      |                 |

REV:

**U**ECR/ECN INFORMATION:EC No.: **UCP2017-2793**DATE: **12/20/2021**TITLE:**KK 100 HEADER ASSY  
FLAT VERTICAL  
BREAKAWAY**SHEET No.**- 35 -**DOCUMENT NUMBER:**SD- 42375-001**CREATED / REVISED BY:**SS06**CHECKED BY:**ISHWARG**APPROVED BY:**ISHWARG**

ENG. NO: 42375-4549

|                   |                            |
|-------------------|----------------------------|
| HEADER NUMBER:    | 42312-0036                 |
| PIN NUMBER:       | 42663-ABB208               |
| PIN LENGTH: L     | .455 / 11.56               |
| MATING LENGTH: M  | .240 / 6.09                |
| GOLD POINT: G     | .100 / 2.54                |
| PC TAIL LENGTH: P | .125 / 3.18                |
| TIN: T            | .100 / 2.54                |
| CKTS:             | 2-36                       |
| KINKS:            | NO                         |
| VOIDED CKTS:      | NONE                       |
| PACKAGING:        | TAPE AND REEL 423751000-PK |

| CKTS | MATERIAL NUMBER | ENG NUMBER | CKTS | MATERIAL NUMBER | ENG NUMBER |
|------|-----------------|------------|------|-----------------|------------|
| 02   | 22-28-4029      | 42375-4549 | 20   |                 |            |
| 03   |                 |            | 21   |                 |            |
| 04   |                 |            | 22   |                 |            |
| 05   |                 |            | 23   |                 |            |
| 06   |                 |            | 24   |                 |            |
| 07   |                 |            | 25   |                 |            |
| 08   |                 |            | 26   |                 |            |
| 09   |                 |            | 27   |                 |            |
| 10   |                 |            | 28   |                 |            |
| 11   |                 |            | 29   |                 |            |
| 12   |                 |            | 30   |                 |            |
| 13   |                 |            | 31   |                 |            |
| 14   |                 |            | 32   |                 |            |
| 15   |                 |            | 33   |                 |            |
| 16   |                 |            | 34   |                 |            |
| 17   |                 |            | 35   |                 |            |
| 18   |                 |            | 36   |                 |            |
| 19   |                 |            |      |                 |            |

|  |  |   |                                |
|--|--|---|--------------------------------|
| REV:<br><b>U</b>                         | ECR/ECN INFORMATION:<br>EC No.: <b>UCP2017-2793</b><br>DATE: <b>12/20/2021</b> | TITLE:<br><b>KK 100 HEADER ASSY<br/>FLAT VERTICAL<br/>BREAKAWAY</b> | SHEET No.<br><b>- 36 -</b>     |
| DOCUMENT NUMBER:<br><b>SD- 42375-001</b> | CREATED / REVISED BY:<br><b>SS06</b>   | CHECKED BY:<br><b>ISHWARG</b>                                       | APPROVED BY:<br><b>ISHWARG</b> |