

EMILY-SS-WAS

~8° beam for wall-washing. 14.83 mm high lens.

SPECIFICATION:

Dimensions	Ø 26.0 mm
Height	14.8 mm
Fastening	tape, pin
ROHS compliant	yes ⓘ

MATERIALS:

Component	Type	Material	Colour	Finish
EMILY-SS-WAS	Single lens	PMMA	clear	
SPUTNIK-TAPE	Tape	Acrylic foam	black	



ORDERING INFORMATION:

Component		Qty in box	MOQ	MPQ	Box weight (kg)
CA11998_EMILY-SS-WAS	Single lens	1690	260	130	11.4
» Box size: 480 x 280 x 300 mm					

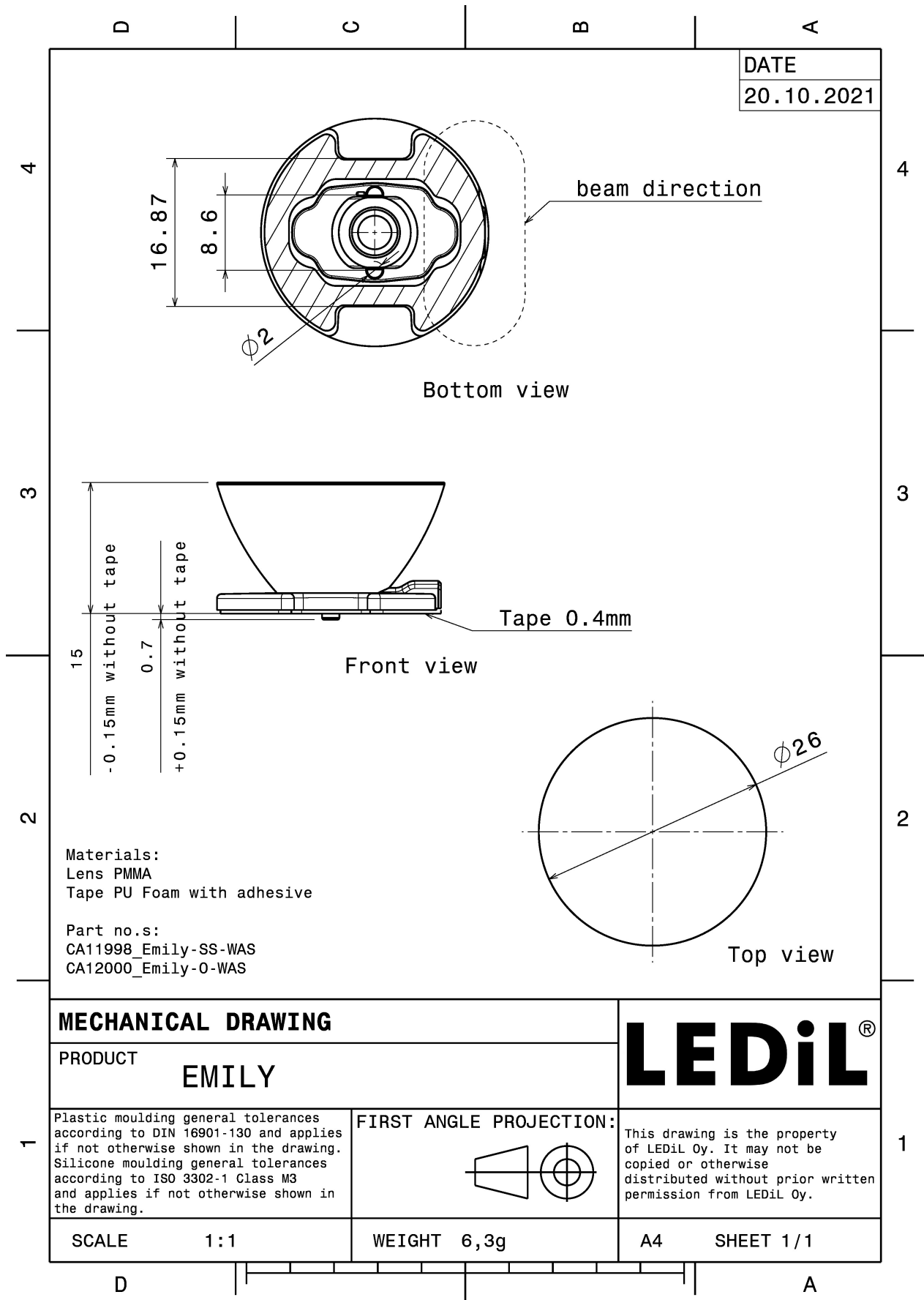

See also our general installation guide: www.ledil.com/installation_guide

OPTICAL RESULTS (MEASURED):

CREE LED

LED XHP35 HD
 FWHM / FWTM Asymmetric
 Efficiency 91 %
 Peak intensity 7.6 cd/lm
 LEDs/each optic 1
 Light colour White
 Required components:

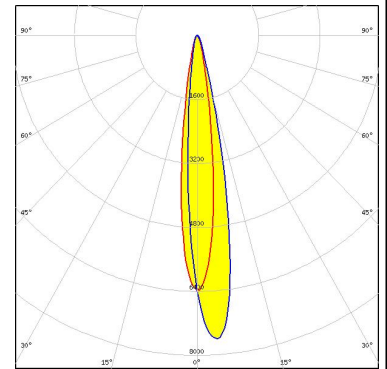

CREE LED

LED XP-E
 FWHM / FWTM 10.0° / 20.0°
 Efficiency 92 %
 Peak intensity 18.3 cd/lm
 LEDs/each optic 1
 Light colour White
 Required components:

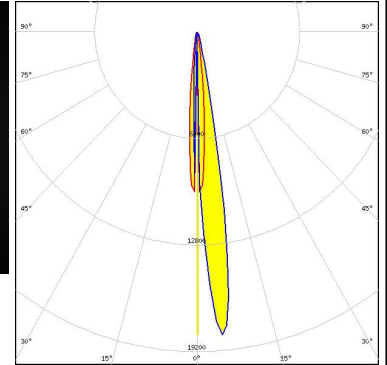

CREE LED

LED XP-G
 FWHM / FWTM 11.0° / 23.0°
 Efficiency 93 %
 Peak intensity 11.9 cd/lm
 LEDs/each optic 1
 Light colour White
 Required components:

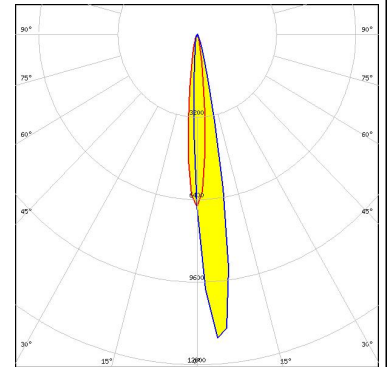

CREE LED

LED XP-L HI
 FWHM / FWTM Asymmetric
 Efficiency 91 %
 Peak intensity 14.6 cd/lm
 LEDs/each optic 1
 Light colour White
 Required components:

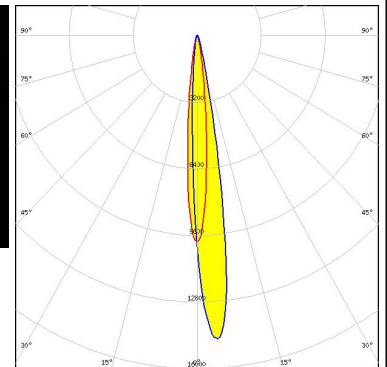

OPTICAL RESULTS (MEASURED):

LUMILEDS

LED LUXEON A
 FWHM / FWTM 12.0° / 25.0°
 Efficiency %
 Peak intensity 10.3 cd/lm
 LEDs/each optic 1
 Light colour White
 Required components:

LUMILEDS

LED LUXEON Rebel
 FWHM / FWTM 8.0° / 23.0°
 Efficiency 88 %
 Peak intensity 11.6 cd/lm
 LEDs/each optic 1
 Light colour White
 Required components:

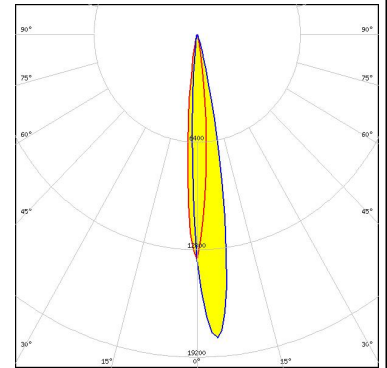

LUMILEDS



LED LUXEON Rebel ES
 FWHM / FWTM 12.0° / 25.0°
 Efficiency 91 %
 Peak intensity 10 cd/lm
 LEDs/each optic 1
 Light colour White
 Required components:

LUMILEDS

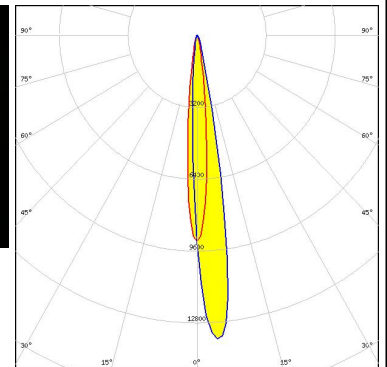
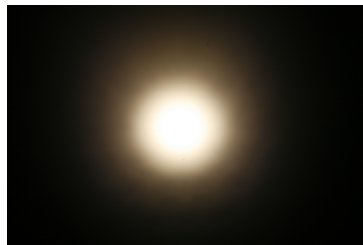
LED LUXEON T
 FWHM / FWTM 11.0° / 22.0°
 Efficiency 89 %
 Peak intensity 14 cd/lm
 LEDs/each optic 1
 Light colour White
 Required components:

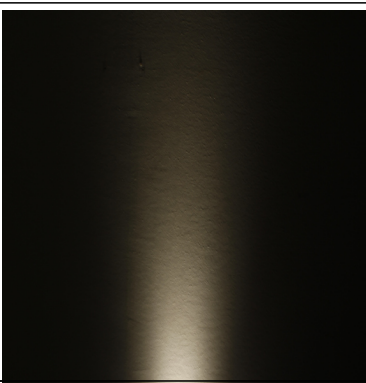
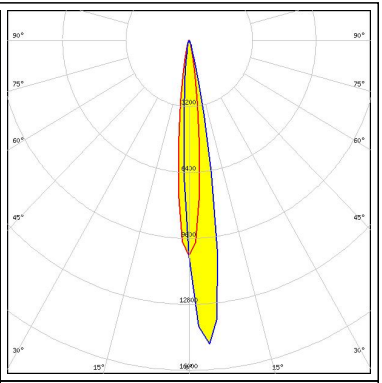

OPTICAL RESULTS (MEASURED):

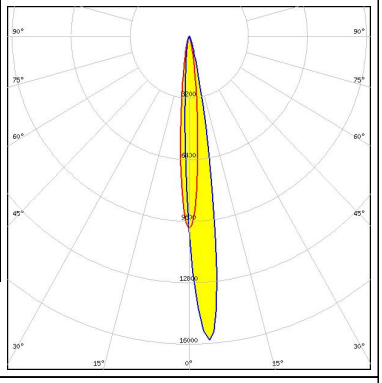
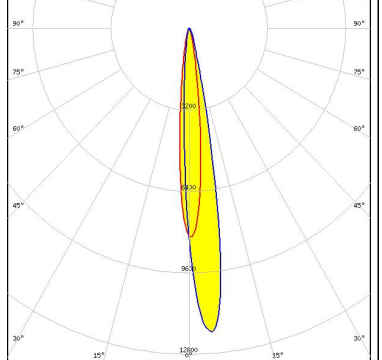
<p>LUMILEDS</p> <p>LED LUXEON TX FWHM / FWTM Asymmetric Efficiency 88 % Peak intensity 14.8 cd/lm LEDs/each optic 1 Light colour White Required components:</p>		
<p>NICHIA</p> <p>LED NCSxx19B FWHM / FWTM 11.0° / 22.0° Efficiency 89 % Peak intensity 15.5 cd/lm LEDs/each optic 1 Light colour White Required components:</p>		
<p>NICHIA</p> <p>LED NVSxx19A FWHM / FWTM 13.0° / 28.0° Efficiency 89 % Peak intensity 8 cd/lm LEDs/each optic 1 Light colour White Required components:</p>		
<p>NICHIA</p> <p>LED NVSxx19B/NVSxx19C FWHM / FWTM Asymmetric Efficiency 93 % Peak intensity 12.1 cd/lm LEDs/each optic 1 Light colour White Required components:</p>		

OPTICAL RESULTS (MEASURED):

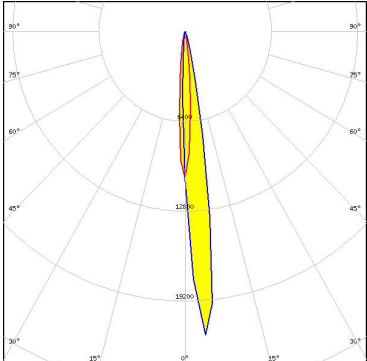
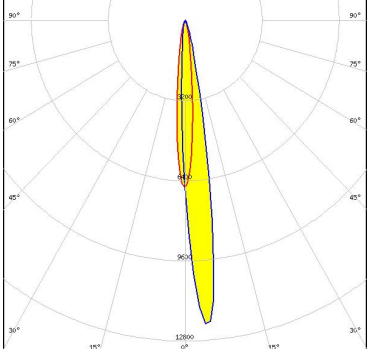
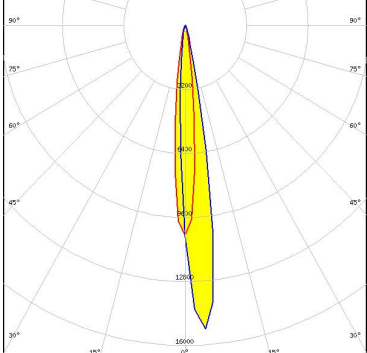
<p>OSRAM Opto Semiconductors</p> <p>LED OSLON SSL 150</p> <p>FWHM / FWTM 11.0° / 22.0°</p> <p>Efficiency 88 %</p> <p>Peak intensity 14.9 cd/lm</p> <p>LEDs/each optic 1</p> <p>Light colour White</p> <p>Required components:</p>	
<p>OSRAM Opto Semiconductors</p> <p>LED OSLON SSL 80</p> <p>FWHM / FWTM 11.0°</p> <p>Efficiency 91 %</p> <p>Peak intensity 11 cd/lm</p> <p>LEDs/each optic 1</p> <p>Light colour White</p> <p>Required components:</p>	
<p>SEOUL SEMICONDUCTOR</p> <p>LED Z5M1/Z5M2</p> <p>FWHM / FWTM Asymmetric</p> <p>Efficiency 88 %</p> <p>Peak intensity 15.2 cd/lm</p> <p>LEDs/each optic 1</p> <p>Light colour White</p> <p>Required components:</p>	

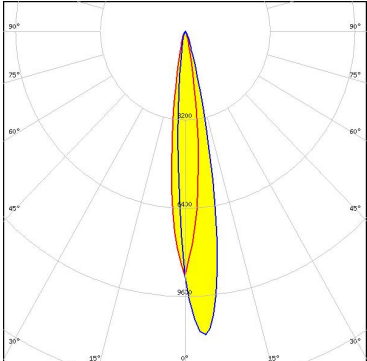
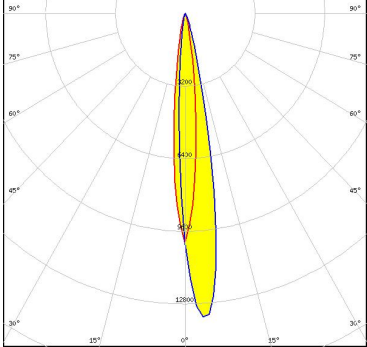
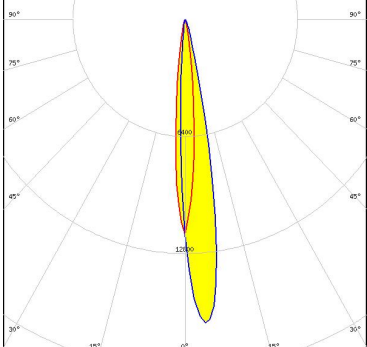
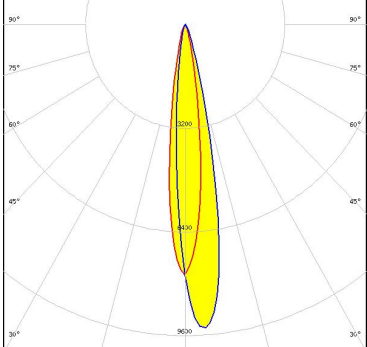

OPTICAL RESULTS (SIMULATED):

<p>CREE LED</p> <p>LED: XT-E FWHM / FWTM: Asymmetric Efficiency: 94 % Peak intensity: 11 cd/lm LEDs/each optic: 1 Light colour: White Required components:</p>	
<p>LUMILEDS</p> <p>LED: LUXEON H50-2 FWHM / FWTM: Asymmetric Efficiency: 92 % Peak intensity: 13.4 cd/lm LEDs/each optic: 1 Light colour: White Required components:</p>	
<p>NICHIA</p> <p>LED: NCSxx19A FWHM / FWTM: Asymmetric Efficiency: 94 % Peak intensity: 16.7 cd/lm LEDs/each optic: 1 Light colour: White Required components:</p>	
<p>NICHIA</p> <p>LED: NV4WB35AM FWHM / FWTM: Asymmetric Efficiency: 95 % Peak intensity: 9.4 cd/lm LEDs/each optic: 1 Light colour: White Required components:</p>	

OPTICAL RESULTS (SIMULATED):

OSRAM

Opto Semiconductors

LED OSCONIQ P 3030
 FWHM / FWTM Asymmetric
 Efficiency 96 %
 Peak intensity 18 cd/lm
 LEDs/each optic 1
 Light colour White
 Required components:

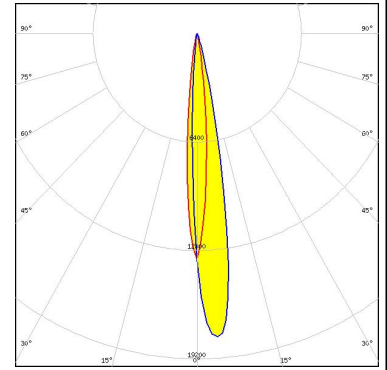

OSRAM

Opto Semiconductors

LED OSCONIQ P 3737 (2W version)
 FWHM / FWTM Asymmetric
 Efficiency 94 %
 Peak intensity 15.3 cd/lm
 LEDs/each optic 1
 Light colour White
 Required components:

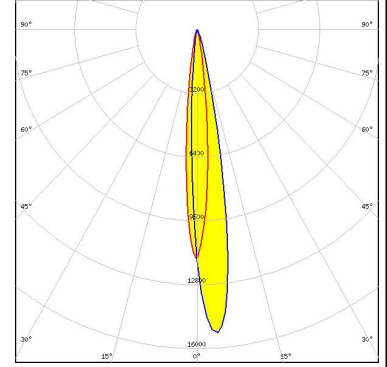

SAMSUNG

LED LM301B
 FWHM / FWTM Asymmetric
 Efficiency 94 %
 Peak intensity 14.6 cd/lm
 LEDs/each optic 1
 Light colour White
 Required components:



SEOUL SEMICONDUCTOR

LED Z5
 FWHM / FWTM Asymmetric
 Efficiency 96 %
 Peak intensity 20.4 cd/lm
 LEDs/each optic 1
 Light colour White
 Required components:

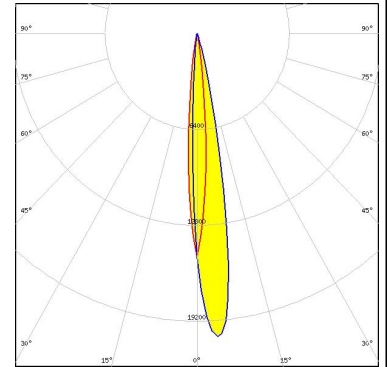

GENERAL INFORMATION:

NOTE: The typical beam angle will be changed by different color, chip size and chip position tolerance. The typical total beam angle is the full angle measured where the luminous intensity is half of the peak value.

MATERIALS:

As part of our continuous research and improvement processes, and to ensure the best possible quality and availability of our products, LEDiL reserves the right to change material grades without notice.

PRODUCT DATA USER AGREEMENT AND DISCLAIMER:

The measured data in the provided downloadable LEDiL Product Datasheets and Mechanical 2D-Drawings is rounded and provided as reference for planning. LEDiL Oy's optical specifications have been verified by conducting performance testing of the products in accordance with the company's quality system. The reported data are averaged results of multiple measurements with typical variation. LEDiL Oy reserves the right to without prior notification make changes and improvements to its products.

LEDiL Oy assumes neither warranty, nor guarantee nor any other liability of any kind for the contents and correctness of the provided data. The provided data has been generated with highest diligence but the provided data may in reality not represent the complete possible variation range of all intrinsic parameters. Therefore, in certain cases a deviation from the provided data could occur.

LEDiL Oy reserves the right to undertake technical changes of its products without further notification which could lead to changes in the provided data. LEDiL Oy assumes no liability of any kind for the possible deviation from any provided data or any other damage resulting from the usage of the provided data.

The user agrees to this disclaimer and user agreement with the download or usage of the provided files.

LEDiL Oy

Joensuunkatu 13
FI-24240 SALO
Finland

LEDiL Inc.

228 West Page Street
Suite D
Sycamore IL 60178
USA

Ledil Optics Technology (Shenzhen) Co., Ltd.

405 , Block B
Casic Motor Building
Shenzhen 518057
P.R.CHINA

Local sales and technical support

[www.ledil.com/
where_to_buy](http://www.ledil.com/where_to_buy)

Shipping locations

Salo, Finland
Hong Kong, China

Distribution Partners

[www.ledil.com/
where_to_buy](http://www.ledil.com/where_to_buy)