

## Thin film chip resistors

2020.2

High reliability Thin film chip resistors  
High durability·High reliability Thin film chip resistors

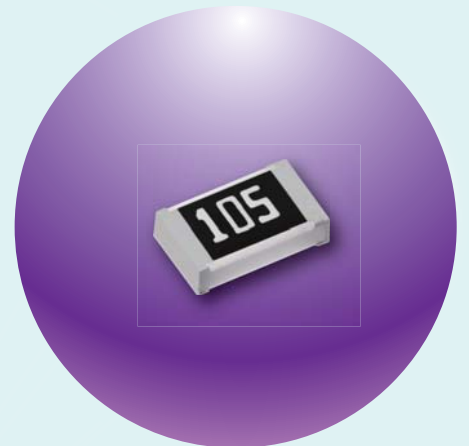
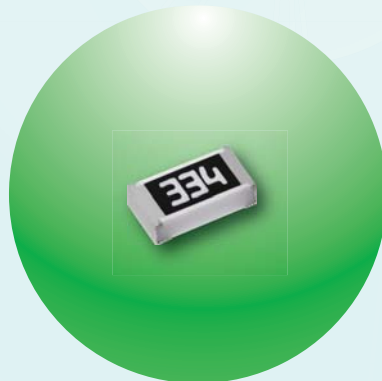

## **Guidelines and precautions regarding the technical information and use of our products described in this online catalog.**

- If you want to use our products described in this online catalog for applications requiring special qualities or reliability, or for applications where the failure or malfunction of the products may directly jeopardize human life or potentially cause personal injury (e.g. aircraft and aerospace equipment, traffic and transportation equipment, combustion equipment, medical equipment, accident prevention, anti-crime equipment, and/or safety equipment), it is necessary to verify whether the specifications of our products fit to such applications. Please ensure that you will ask and check with our inquiry desk as to whether the specifications of our products fit to such applications use before you use our products.
- The quality and performance of our products as described in this online catalog only apply to our products when used in isolation. Therefore, please ensure you evaluate and verify our products under the specific circumstances in which our products are assembled in your own products and in which our products will actually be used.
- If you use our products in equipment that requires a high degree of reliability, regardless of the application, it is recommended that you set up protection circuits and redundancy circuits in order to ensure safety of your equipment.
- The products and product specifications described in this online catalog are subject to change for improvement without prior notice. Therefore, please be sure to request and confirm the latest product specifications which explain the specifications of our products in detail, before you finalize the design of your applications, purchase, or use our products.
- The technical information in this online catalog provides examples of our products' typical operations and application circuits. We do not guarantee the non-infringement of third party's intellectual property rights and we do not grant any license, right, or interest in our intellectual property.
- If any of our products, product specifications and/or technical information in this online catalog is to be exported or provided to non-residents, the laws and regulations of the exporting country, especially with regard to security and export control, shall be observed.

## **<Regarding the Certificate of Compliance the EU RoHS Directive/REACH Regulations>**

- The switchover date for compliance with the RoHS Directive/REACH Regulations varies depending on the part number or series of our products.
- If you are not sure whether it applies to RoHS/REACH directive or not when using stock items, please do not hesitate to contact our sales representative.

### ■ AEC-Q200 compliant

The products are tested based on all or part of the test conditions and methods defined in AEC-Q200. Please consult with Panasonic for the details of the product specification and specific evaluation test results, etc., and please review and approve Panasonic's product specification before ordering.

**We do not take any responsibility for the use of our products outside the scope of the specifications, descriptions, guidelines and precautions described in this online catalog.**



# 85 years history of Panasonic resistors

Panasonic has produced resistors for more than 85 years. Based on the concept, "Good products begin with Good components." by our founder Konosuke Matsushita, Panasonic started manufacturing fixed carbon film resistors for radio receivers in 1933 and reached the milestone of accumulative 2 trillion pieces production by 2013. By lining up with this number of resistors, standard 1608 mm size, we can make a round trip to the moon (244,198 miles).

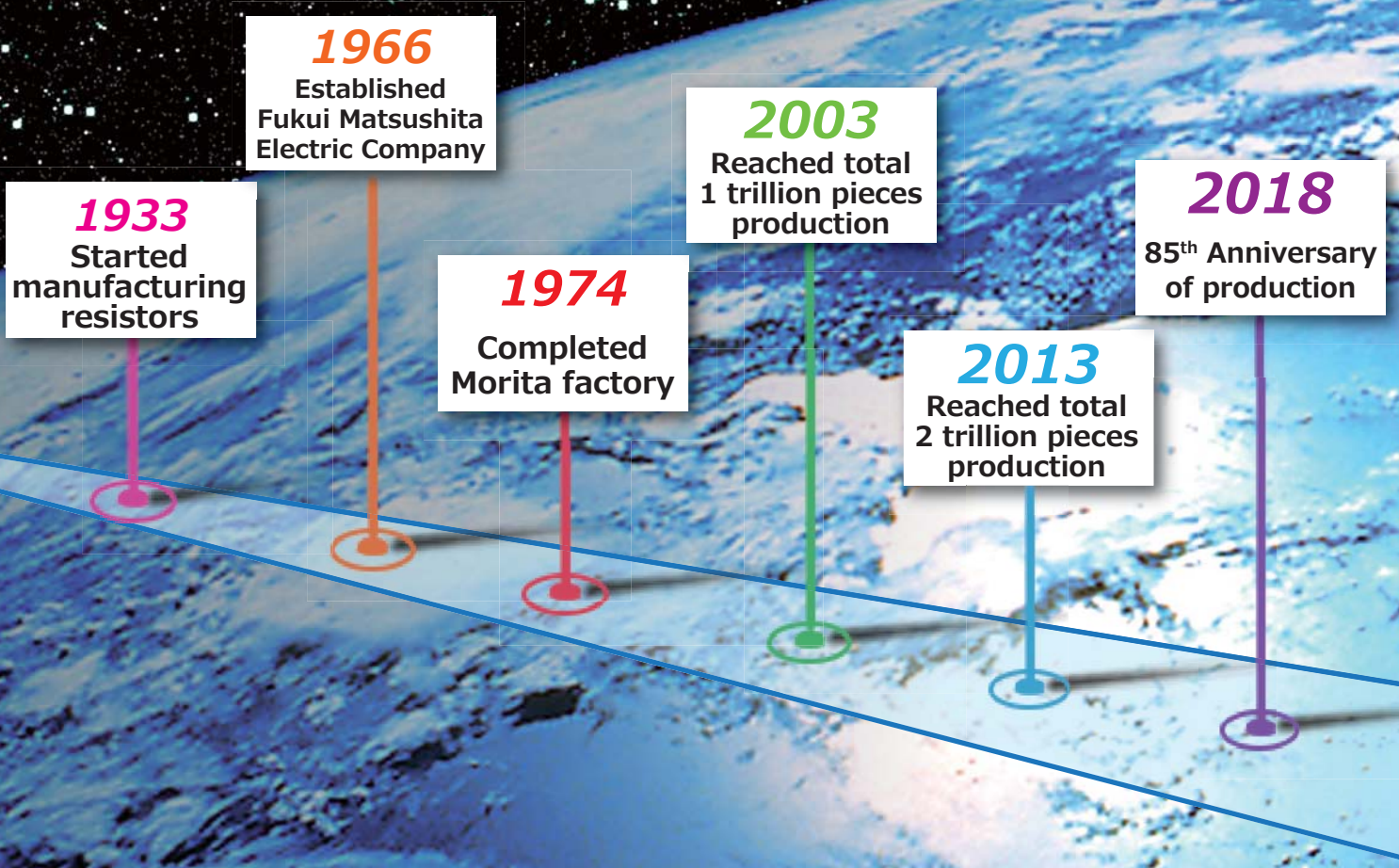



# Panasonic chip resistors, product line-up

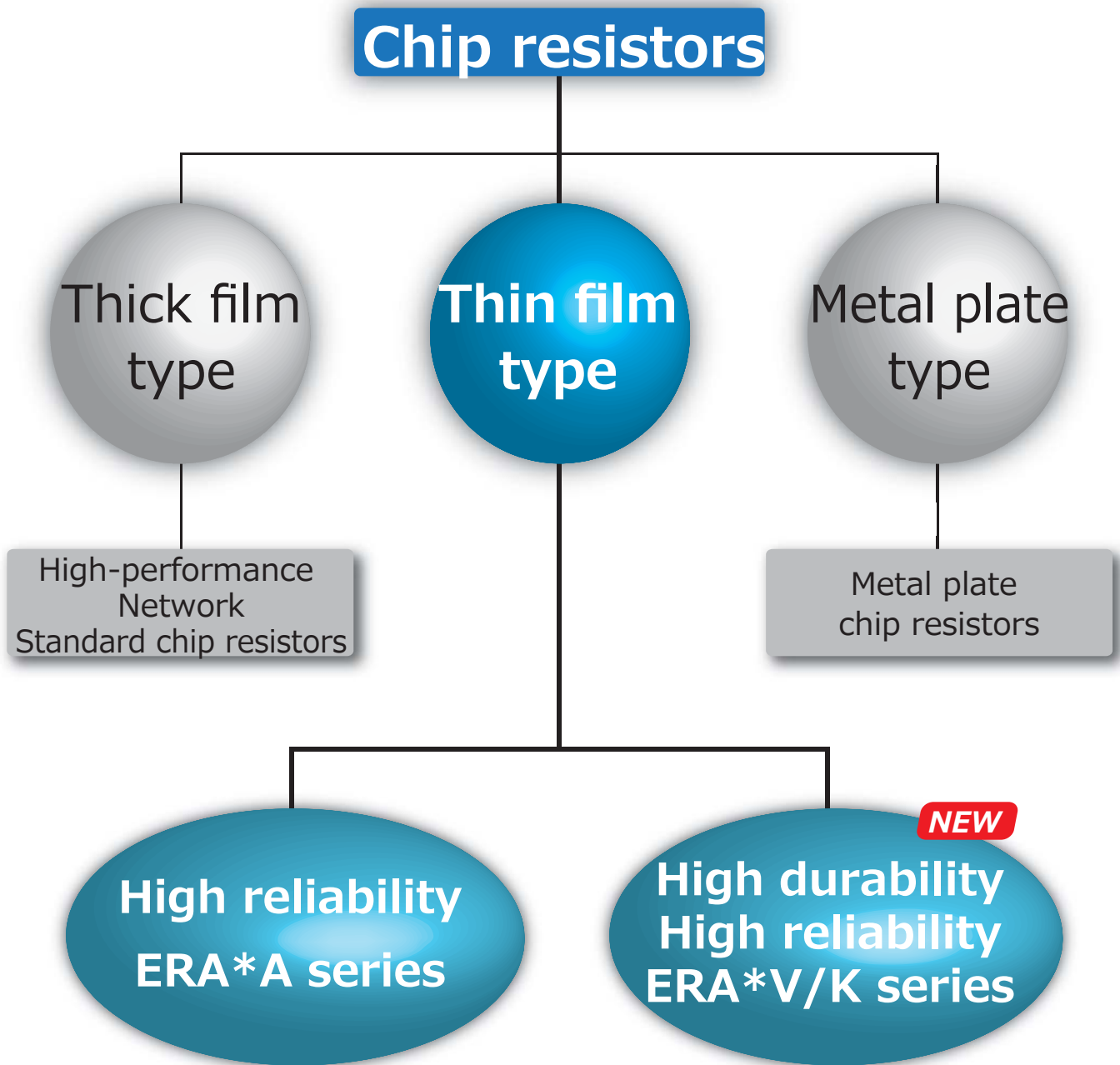

[Icon description]

**Anti-surge**

: Improving durability for overloading

**Anti-Solder joint crack**

: Reducing anti-solder joint crack in heat cycle environment

**Anti-Sulfurated**

: Reducing variation of resistance value under sulfur environment

**High precision**

: Significantly reducing total resistance tolerance

**Low TCR**

: Reducing variation of resistance value under temperature variation

**AEC-Q200**

: AEC-Q200 compliant

※Some exceptions

# Proper Usage: Thick film & Thin film chip resistors

## Tolerance · TCR Matrix

TCR(ppm/K) \ Tolerance (%)	10	15	25	50	100	100 <
0.05						Thick film chip area
0.1	<b>ERA*V/K</b>		<b>ERA*A</b>			
0.5						
1	<b>Thin film chip area</b>					
5						

※Our recommended combinations for Tolerance & TCR

## Chip resistors flowchart

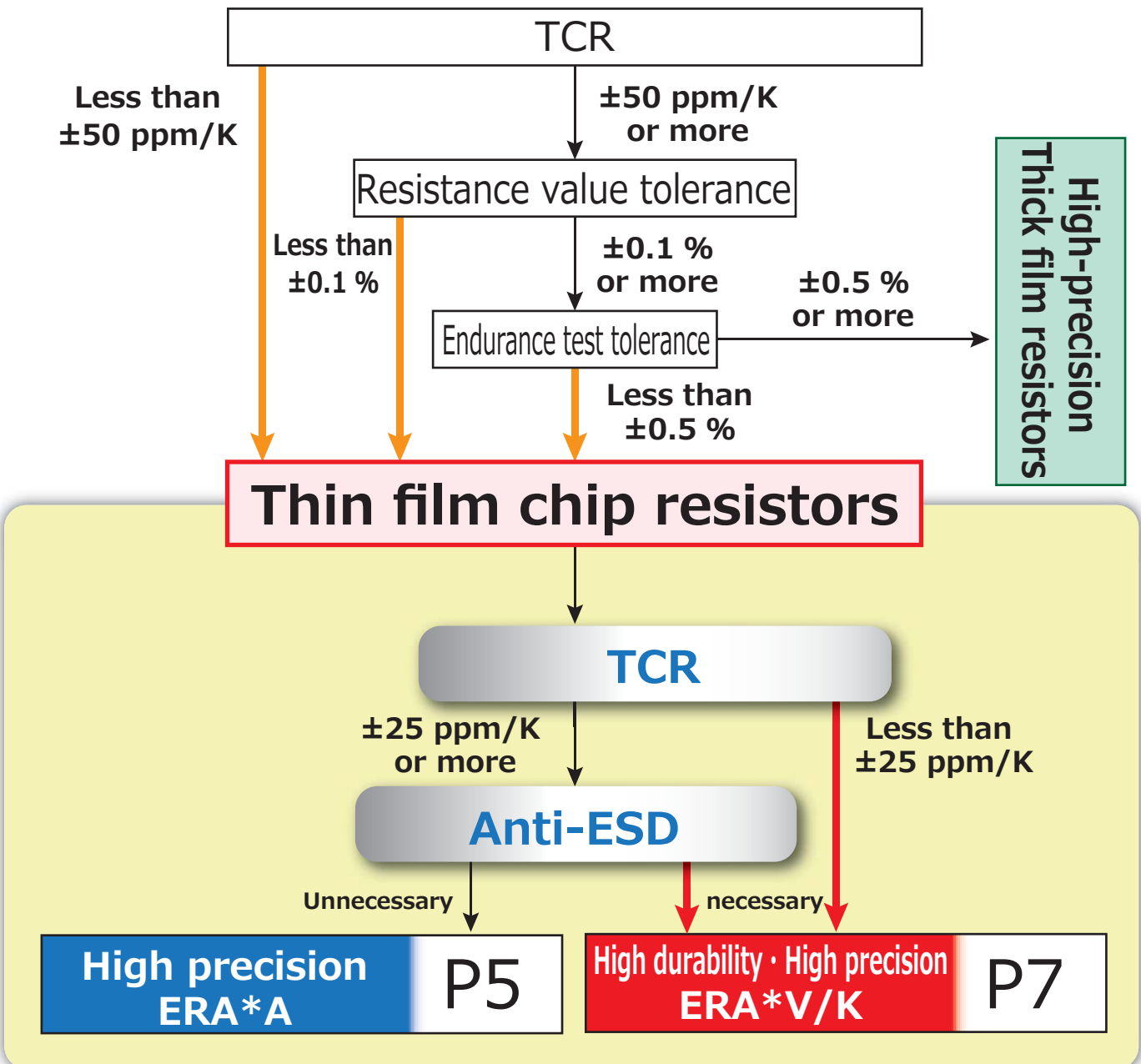

# High precision Thin film chip resistors

High precision

Low TCR

Anti-solder joint crack

AEC-Q200

## ERA\*A series



Reduce total resistance value by 1/4 from high-precision thick film resistors

- ✓ Resistance tolerance  $\pm 0.1\%$
- ✓ TCR  $\pm 25$  ppm/K
- ✓ Endurance test tolerance  $\pm 0.1\%$

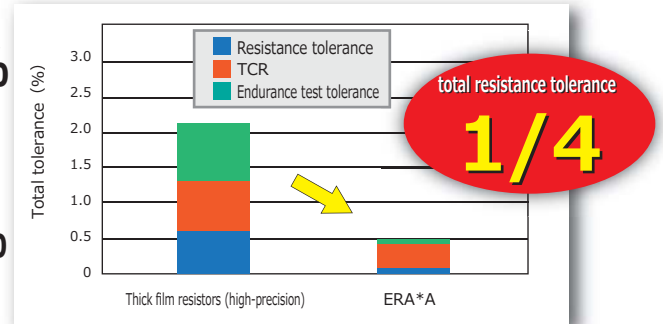

## Quarter total resistance from high-precision thick film resistors

1. Suppress deterioration of set's performance and reliability in long-term use and temperature change
2. Save design cost by design margin securing



Point

Achieving high-precision (Endurance test tolerance  $\pm 0.1\%$ ) by original Ni & Cr & Si - High-precision resistance materials and protecting resistor by Sputter protection film.

- Endurance load test (1 k $\Omega$ )  
85°C, 85%RH, Rated load, 1608 Thick film resistors

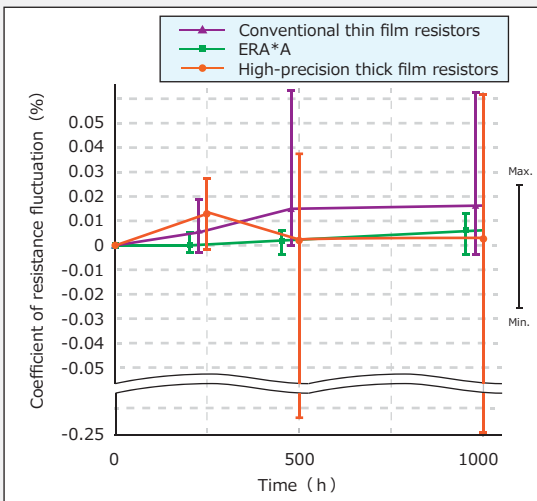

- Structural drawing

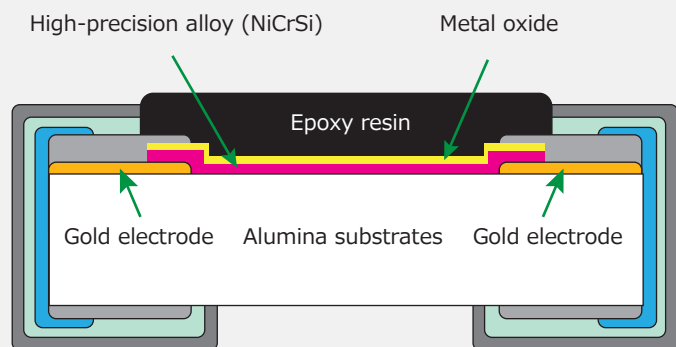



## Soft termination technology adopted

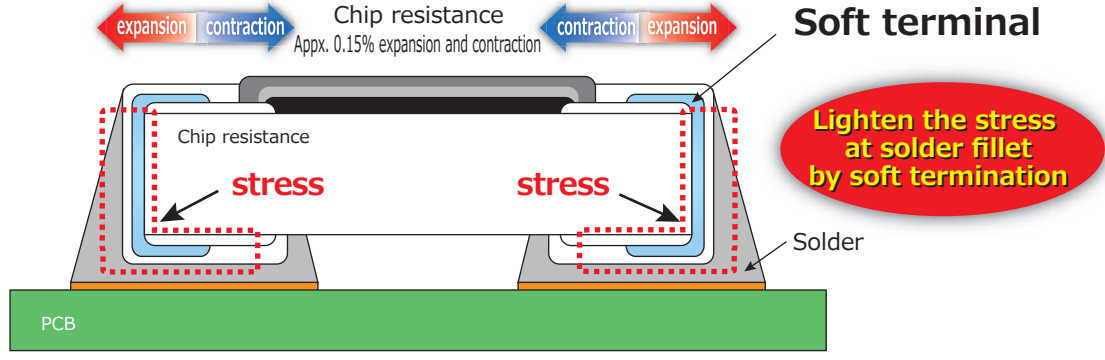

[ Thermal shock test (-55°C to 155°C 2500cycle) solder joint crack ratio ]

Cycle	500	1000	1500	2000	2500
Conventional thin film chip resistors	0 % 	60 % 	80 % 	100 % 	100 % 
ERA*A	0 % 	0 % 	0 % 	40 % 	90 % 

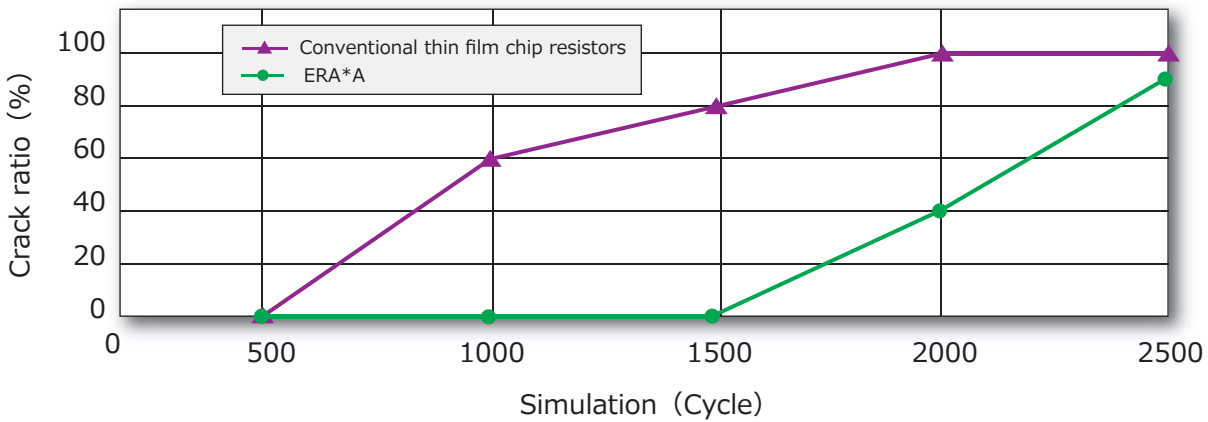

■ Specifications

Part No.	Size (mm)	Power rating (W)	Limiting element voltage (V)	Resistance tolerance (%)	Resistance range (Ω)	TCR (x10 <sup>-6</sup> / K)	Category temp. range (°C)	AEC-Q200
ERA1AEB	0603	0.05	25	± 0.1	100 to 10 k	± 25	-55 to 155	—
ERA2AEB	1005	0.063	50	± 0.1	47 to 100 k	± 25		Grade 1
ERA3AEB	1608	0.1	75	± 0.1	47 to 330 k	± 25		Grade 0
ERA6AEB	2012	0.125	100	± 0.1	47 to 1 M	± 25		
ERA8AEB	3216	0.25	150	± 0.1	47 to 1 M	± 25		

Please visit our website for details !



# High precision · High durability Thin film chip resistors

High precision

Low TCR

Anti-solder joint crack

Anti-sulfurated

Anti-surge

AEC-Q200

## ERA\*V/K series



Achieving higher-precision and longer-life than ERA\*A series

- ✓ Resistance tolerance  $\pm 0.05\%$
- ✓ TCR  $\pm 10$  ppm/K
- ✓ Endurance test tolerance  $\pm 0.1\%$

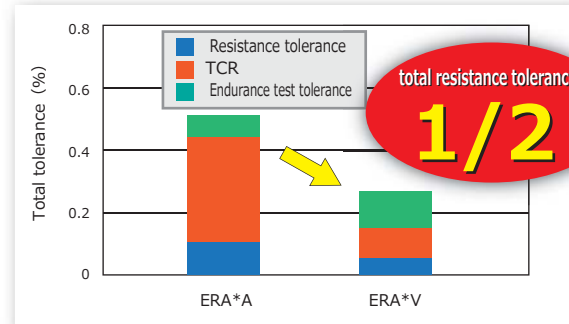

## Half total resistance from thin film chip resistors (ERA\*A series)

1. High-precision, design margin securing and improve performance
2. Improve reliability in severe conditions



Point

Current intense prevention by resistor pattern & improve anti-ESD by reducing electric field strength

### Anti-ESD

- ESD test (1 k $\Omega$ )  
HBM : 150pF, 2kV,  $\pm 5$  times  
1608 thin film chip resistors

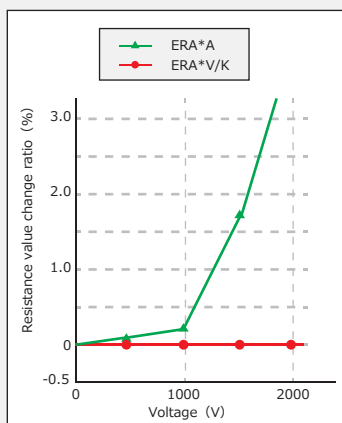

- Anti-ESD improved design

#### Resistor film thickness regularization

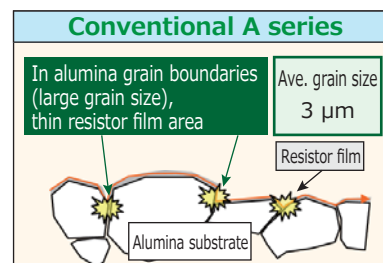

#### Current intense prevention

Regularize resistor film by smoothing surface of alumina substrates and prevent current intensity

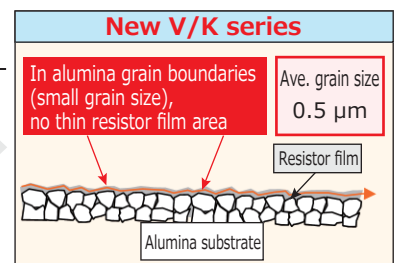

Intensity of overcurrent locally  $\rightarrow$  **Destory resistor**

No intensity of overcurrent  $\rightarrow$  **No destory resistor**

#### Expand resistor pattern length

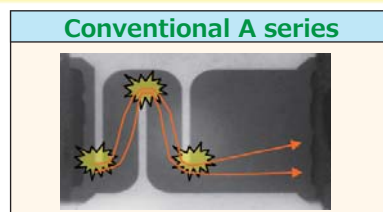

#### Electric field strength reduction

Reduce electric potential difference on length wise by expanding resistor pattern length







## Improve anti-sulfurated by the introduction of edge sputtering electrode covering gap between protection film and electrode

### Anti-sulfurated

- Sulfurization gas test  
ASTM B809 : 105°C 1608 Thin film chip resistors

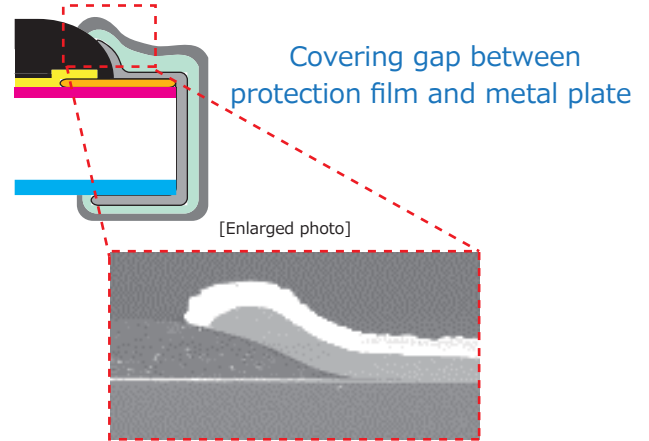
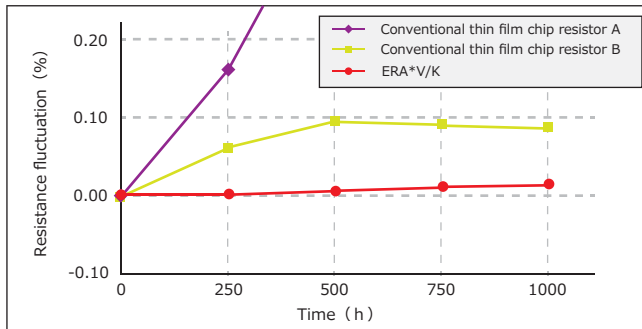

## Achieve excellent anti-solder joint crack by back side resin layer

Chip resistance  
Appx. 0.15% expansion and contraction

Lighten the stress at solder fillet by back side resin layer

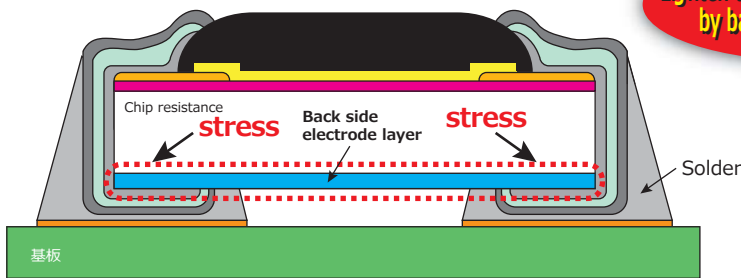

PCB  
Appx. 0.3% expansion and contraction

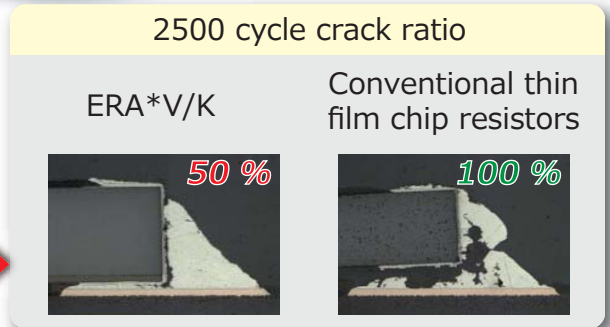

### Specifications

Part No.	Size (mm)	Power rating (W)	Limiting element voltage (V)	Resistance tolerance (%)	Resistance range ( $\Omega$ )	TCR ( $\times 10^{-6} / K$ )	ESD withstand voltage (kV)	Category temp. range ( $^{\circ}C$ )	AEC-Q200
ERA2V	1005	0.063	50	$\pm 0.1$ $\pm 0.05$	$1 k \leq R \leq 10 k$	$\pm 10(R)$ $\pm 15(P)$	1.0		
					$47 \leq R \leq 10 k$	$\pm 25(E)$			
ERA3V ERA3K (100 k $\Omega$ over)	1608	0.100	75	$\pm 0.1$ $\pm 0.05$	$1 k \leq R \leq 100 k$	$\pm 10(R)$ $\pm 15(P)$	1.5		
					$47 \leq R \leq 240 k$	$\pm 25(E)$			
ERA6V ERA6K (100 k $\Omega$ over)	2012	0.125	100	$\pm 0.1$ $\pm 0.05$	$1 k \leq R \leq 100 k$	$\pm 10(R)$ $\pm 15(P)$	2.0		
					$47 \leq R \leq 750 k$	$\pm 25(E)$			
ERA8V ERA8K (100 k $\Omega$ over)	3216	0.250	150	$\pm 0.1$ $\pm 0.05$	$1 k \leq R \leq 100 k$	$\pm 10(R)$ $\pm 15(P)$	2.0		
					$47 \leq R \leq 1 M$	$\pm 25(E)$			

Please visit our website for details !



# Application

## Application Example ①

### Current detection amplifier circuit for motor drive control unit

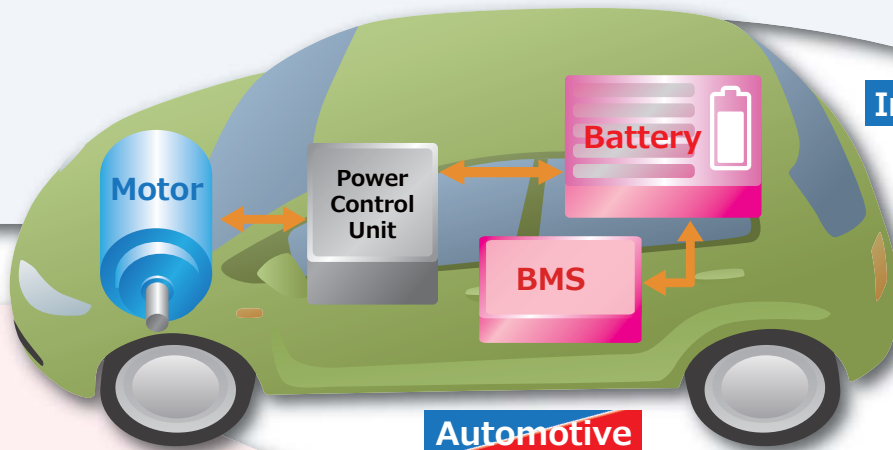
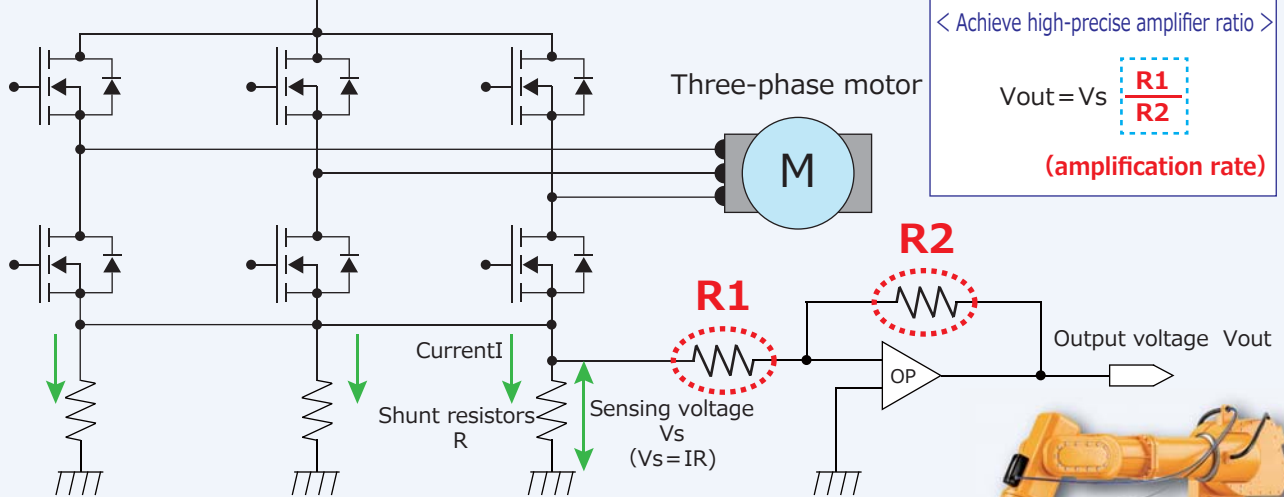

Industrial robot

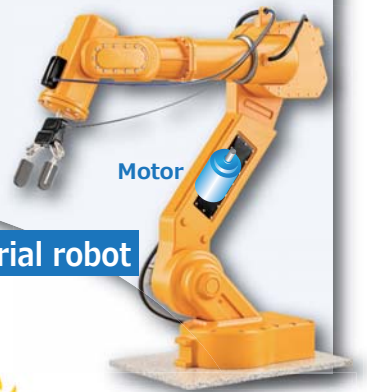

Solar panels

## Application Example ②

### Voltage detection circuit for battery unit

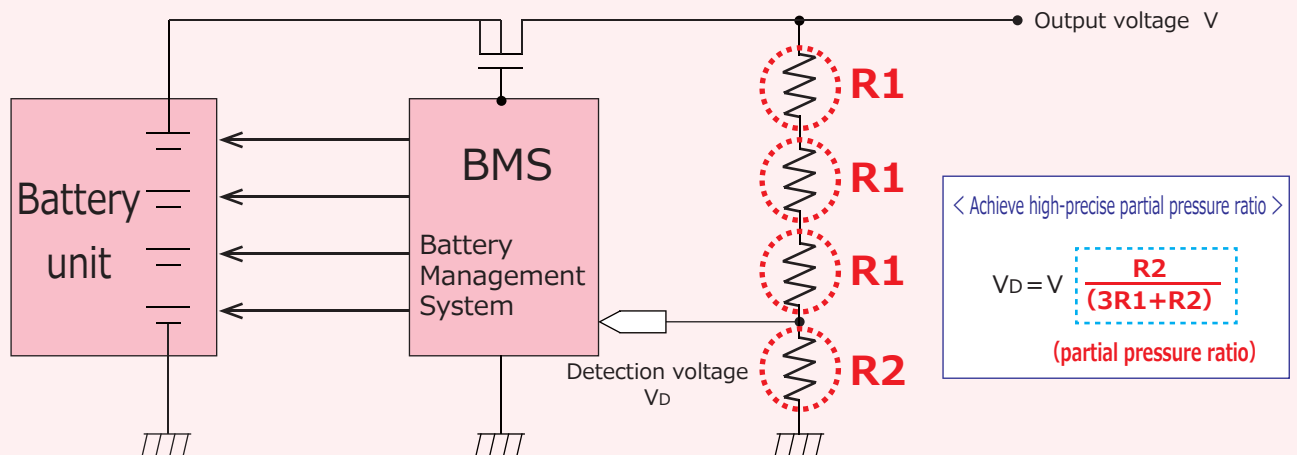

# Main locations

## ■ Japan bases

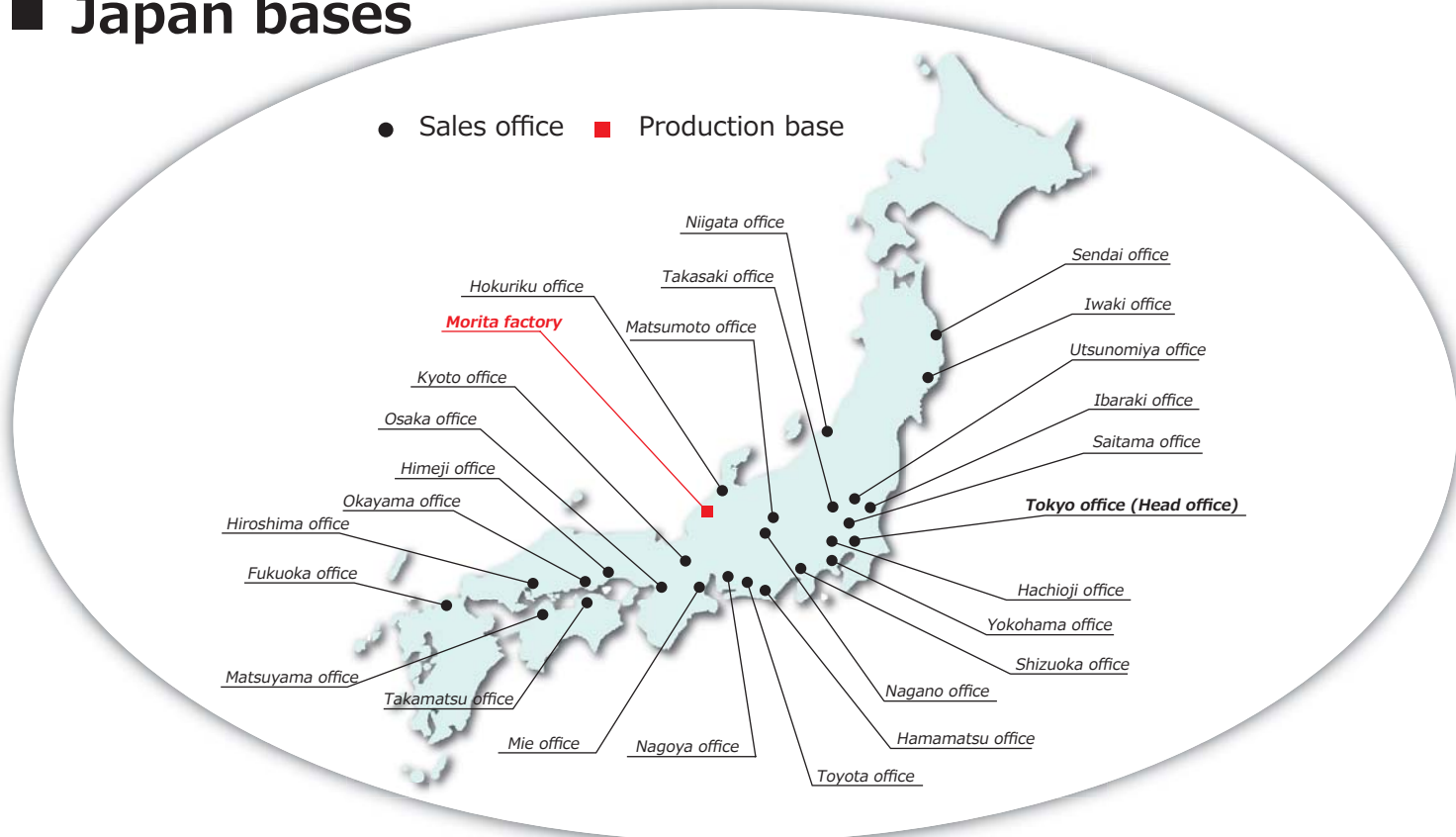

## ■ Overseas bases

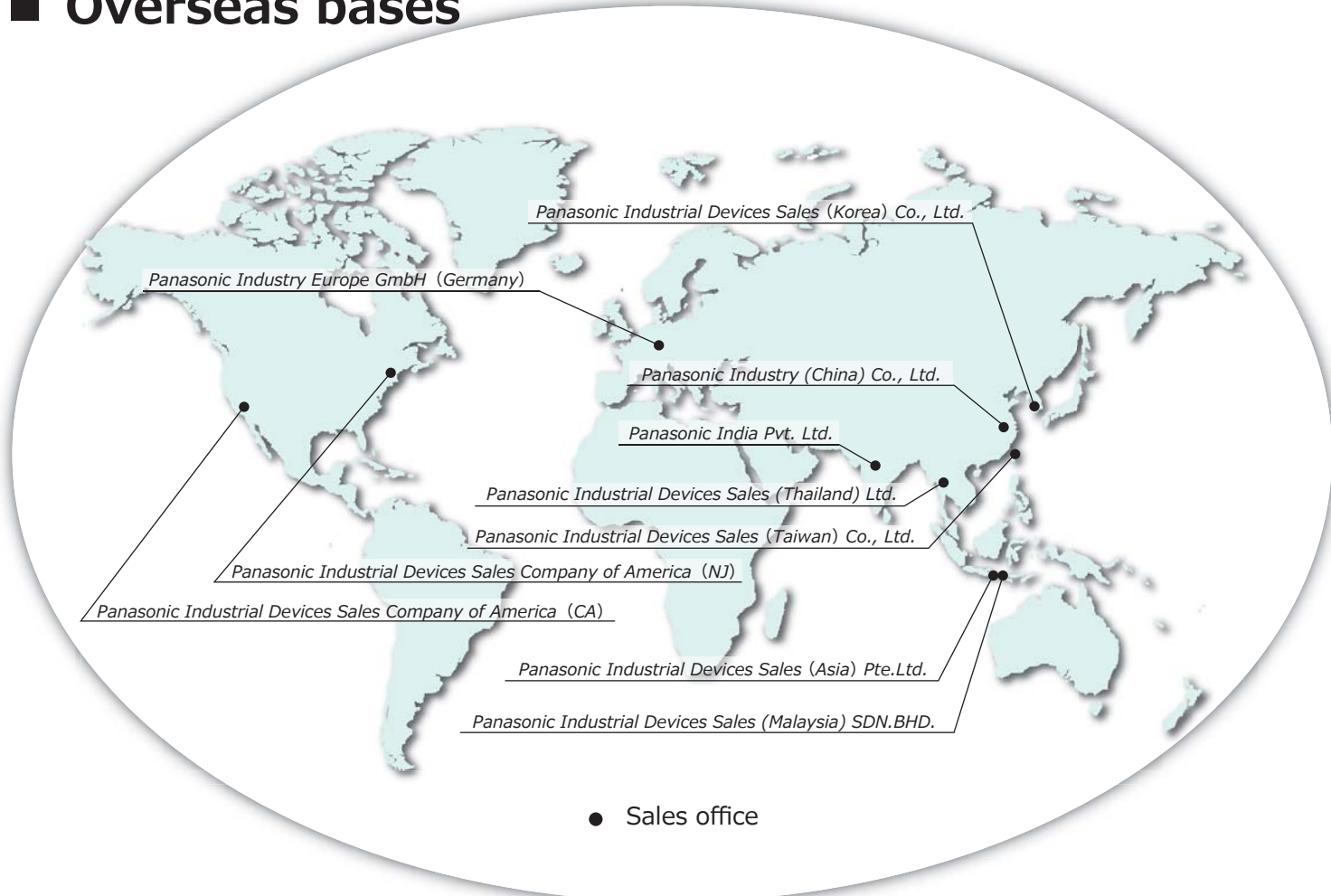



### CAUTION AND WARNING

1. The electronic components contained in this catalog are designed and produced for use in home electric appliances, office equipment, information equipment, communications equipment, and other general purpose electronic devices. Before use of any of these components for equipment that requires a high degree of safety, such as medical instruments, aerospace equipment, disaster-prevention equipment, security equipment, vehicles (automobile, train, vessel), please be sure to contact our sales representative corporation.
2. When applying one of these components for equipment requiring a high degree of safety, no matter what sort of application it might be, be sure to install a protective circuit or redundancy arrangement to enhance the safety of your equipment. In addition, please carry out the safety test on your own responsibility.
3. When using our products, no matter what sort of equipment they might be used for, be sure to make a written agreement on the specifications with us in advance.
4. Technical information contained in this catalog is intended to convey examples of typical performances and or applications and is not intended to make any warranty with respect to the intellectual property rights or any other related rights of our company or any third parties nor grant any license under such rights.
5. In order to export products in this catalog, the exporter may be subject to the export license requirement under the Foreign Exchange and Foreign Trade Law of Japan.
6. No ozone-depleting substances (ODSs) under the Montreal Protocol are used in the manufacturing processes of Automotive & Industrial Systems Company, Panasonic Corporation.

● Please contact \_\_\_\_\_

High performance chip resistor

First edition : January 31, 2020

● Factory \_\_\_\_\_

Device Solutions Business Division  
Industrial Solutions Company

**Panasonic**<sup>®</sup>

1006 Kadoma, Kadoma City, Osaka 571-8506,  
JAPAN

The information in this catalog is valid as of January 2020.