

HC5

High Power Resonant Capacitors

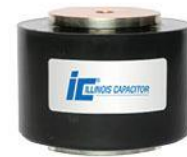

FEATURES

High AC Voltage - High Current

APPLICATIONS

Induction Heating - Tank Circuits

KVAR	500
CAPACITANCE TOLERANCE	+/-10%
MAXIMUM CORE TEMPERATURE	+85°C
SURFACE TEMPERATURE	+45°C (Above 45°C the KVAR rating must be de-rated by 2.25%/°C)
CONSTRUCTION	Self-healing
SELF INDUCTANCE	< 3 nH
DIELECTRIC	Polypropylene
FLAME RETARDANT	UL94V0

Standard Part Listing

Capacitance (µF)	VAC	IC part number	Maximum RMS current (A)	MAX power kvar	Frequency range (kHz)	ESR (mΩ) 100kHz, +25°C	Dimensions (mm)			Terminal Style
							D	H	d	
1.2	1100	125HC5112KR	600	500	55-96	1.5	80	71.5	60	R
1.4	1100	145HC5112KR	600	500	46-83	1.2	80	71.5	60	R
3.0	750	305HC5750KR	800	500	47-68	1.1	80	71.5	60	R
3.3	750	335HC5750KR	800	500	43-62	1.0	80	71.5	60	R
4.0	900	405HC5900KR	700	500	25-39	0.9	102	71.5	60	R
5.6	700	565HC5700KR	1000	500	29-57	0.9	80	71.5	60	R
6.3	700	635HC5700KR	1000	500	26-51	0.8	80	71.5	60	R
8.5	700	855HC5700KR	1000	500	19-38	0.7	88	71.5	60	R
10	700	106HC5700KR	1000	500	16-32	0.6	95	71.5	60	R
21	500	216HC5500KR	1000	500	15	0.4	80	71.5	60	R
27	550	276HC5550KR	1000	500	10-12	0.3	102	71.5	60	R
33	500	336HC5500KR	1000	500	10	0.3	102	71.5	60	R
37	500	376HC5500KR	1000	500	9	0.2	102	71.5	60	R

Americas / EU

Phone: 1-508-996-8561

Email: cdena@cde.com



**CORNELL
DUBILIER**



Asia

Phone: 852-2793-0931

Email: cdeasia@cde.com

HC5

High Power Resonant Capacitors



Terminal Style: R

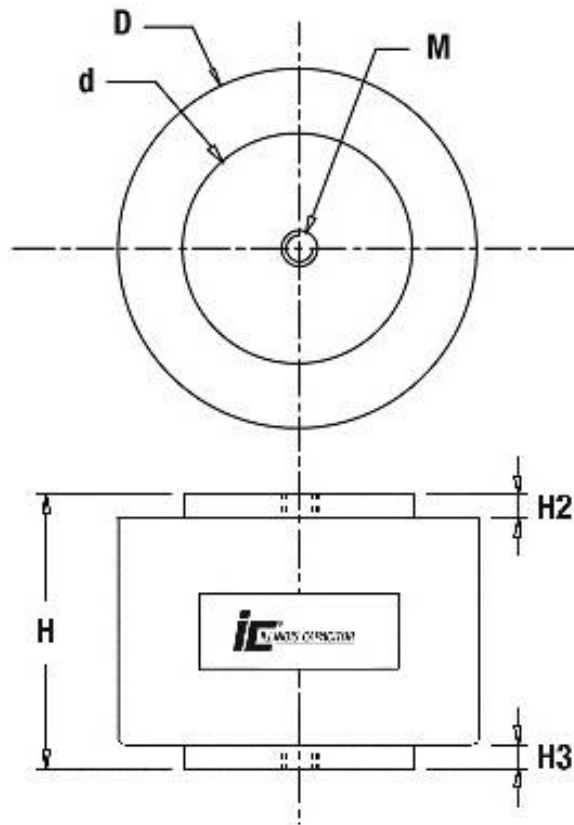

D	H	d	H2	H3
80 ₊₁	71.5 _{+0.1}	60 ₊₁	6 _{+0.5}	6 _{+0.5}
88 ₊₁				
95 ₊₁				
102 ₊₁				
Mounting holes (M): M8x1.25, 9.5mm deep with SS helicoil				
Terminations: Copper finish Rz6.3				
Tightening torque: 15Nm Max				

Americas / EU
 Phone: 1-508-996-8561
 Email: cdena@cde.com



Asia
 Phone: 852-2793-0931
 Email: cdeasia@cde.com

HC5

High Power Resonant Capacitors

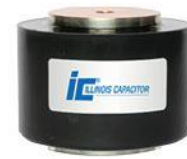

Frequency Derating

—●— Voltage —■— Current —▲— Power

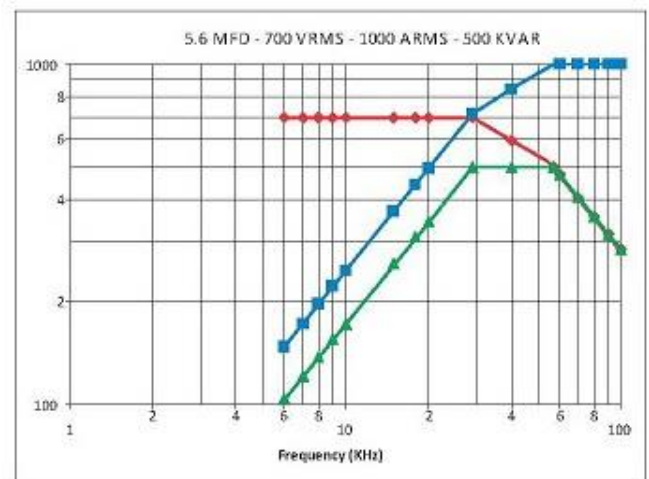
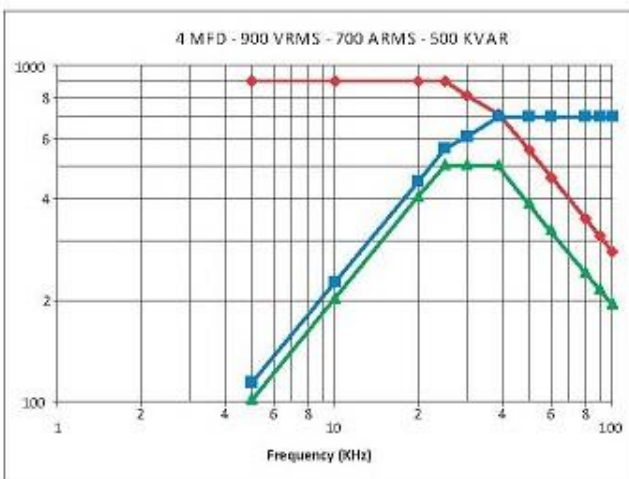
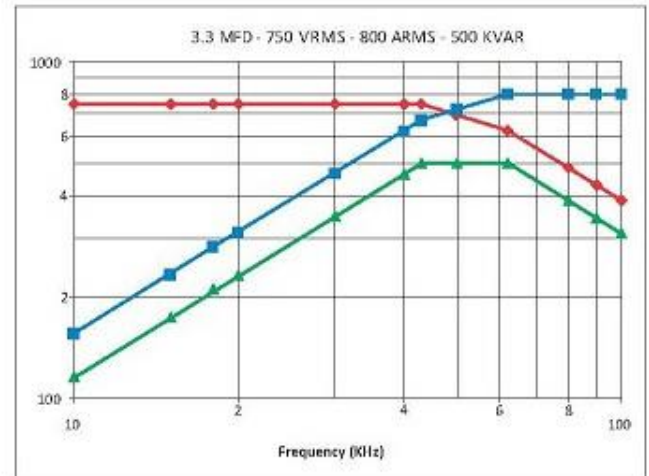
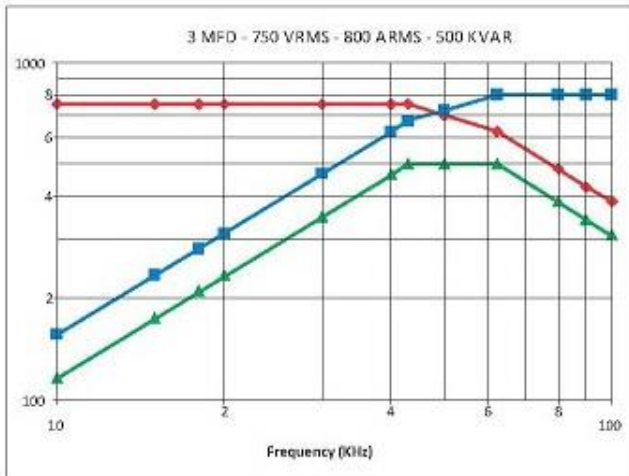
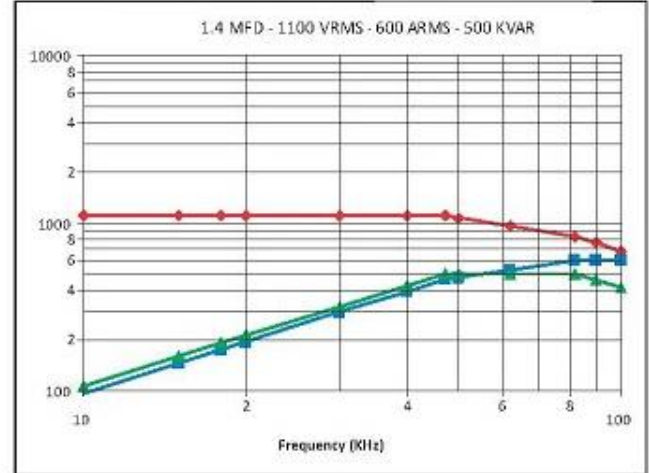
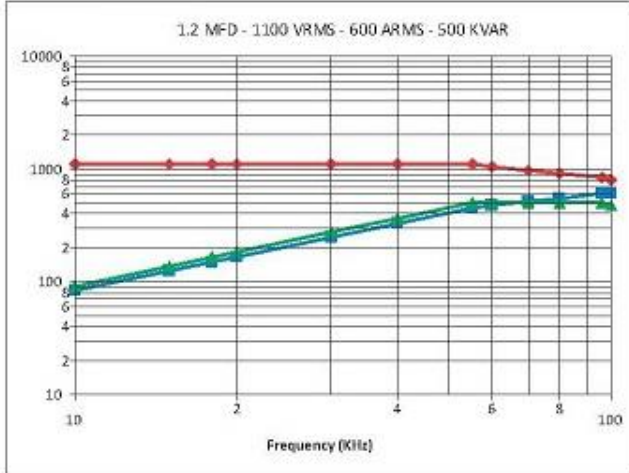

Americas / EU
 Phone: 1-508-996-8561
 Email: cdena@cde.com



Asia
 Phone: 852-2793-0931
 Email: cdeasia@cde.com

HC5

High Power Resonant Capacitors



Frequency Derating

— Voltage — Current — Power

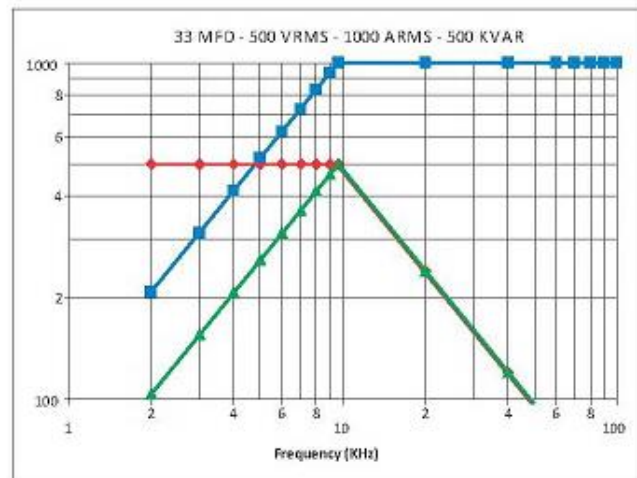
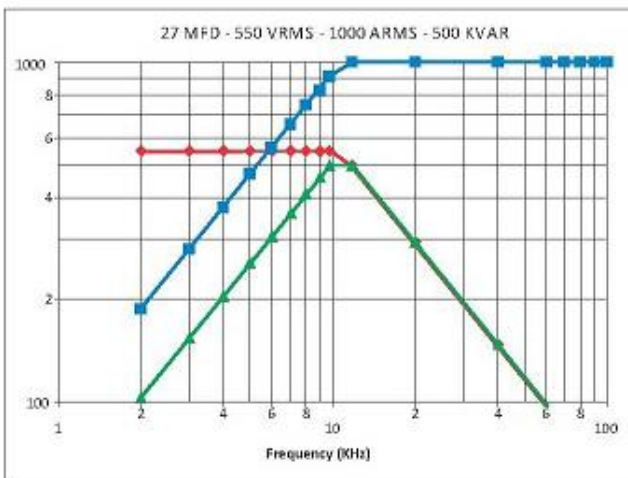
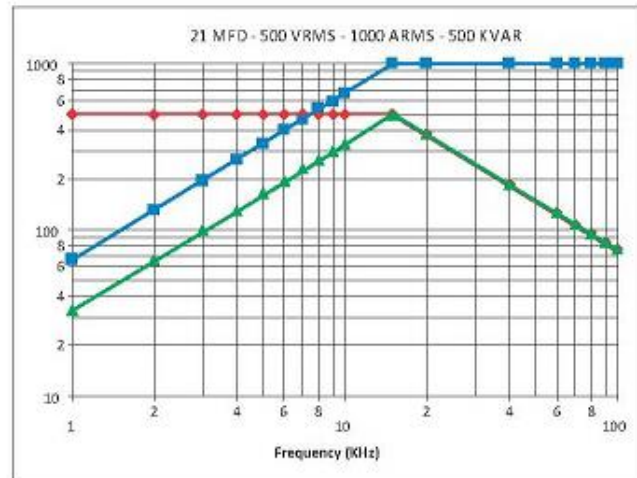
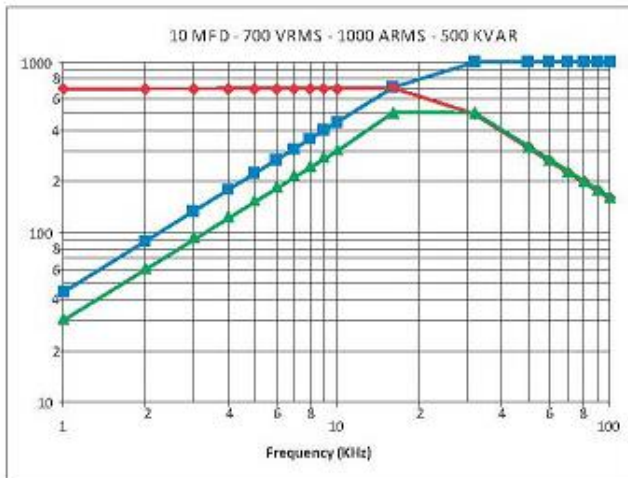
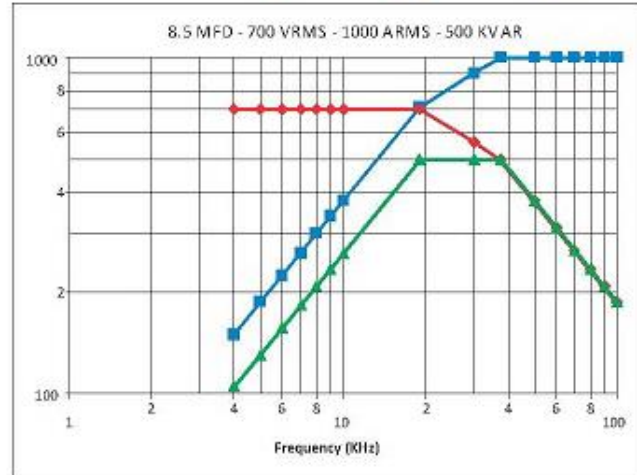
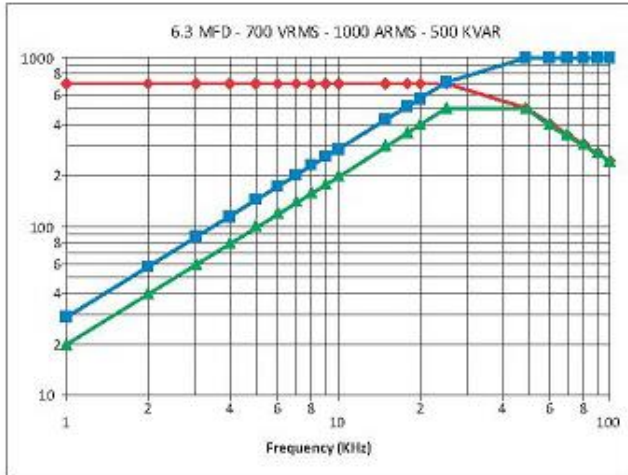

Americas / EU
 Phone: 1-508-996-8561
 Email: cdena@cde.com



Asia
 Phone: 852-2793-0931
 Email: cdeasia@cde.com

HC5

High Power Resonant Capacitors



Frequency Derating

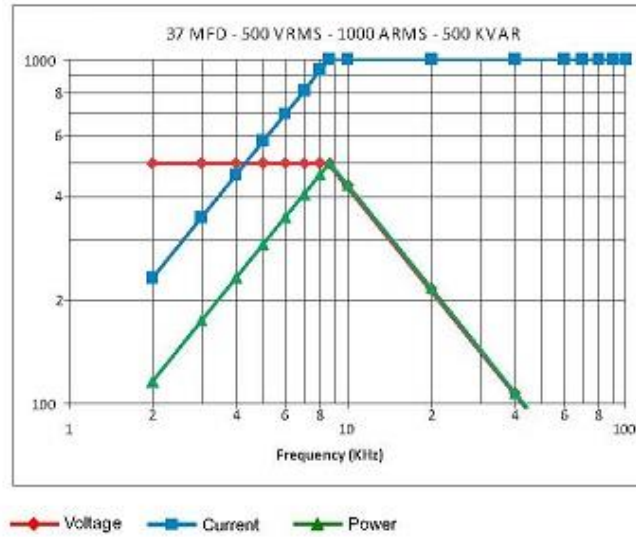

Americas / EU
 Phone: 1-508-996-8561
 Email: cdena@cde.com



Asia
 Phone: 852-2793-0931
 Email: cdeasia@cde.com