

Data sheet | Item number: 264-240

4-conductor terminal strip; without push-buttons; suitable for Ex e II applications; with fixing flanges; 10-pole; for screw or similar mounting types; Fixing hole 3.2 mm Ø; 2.5 mm²; CAGE CLAMP®; 2,50 mm²; light gray

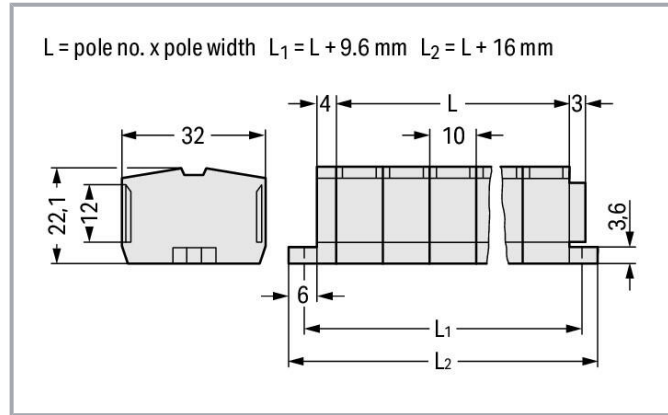

www.wago.com/264-240



Data

Electrical data

Ex information

Reference hazardous areas

See "Downloads – Documentation – Additional Information: Technical Section; Technical Explanations"

Rated voltage EN (Ex e II)

690 V

Rated current (Ex e II)

23 A

Connection data

Connection points

40

Total number of potentials

10

Number of levels

1

Subject to changes. Please also observe the further product documentation!

WAGO GmbH & Co. KG

Hansastr. 27

32423 Minden

Phone: +49571 887-0 | Fax: +49571 887-169

Email: info.de@wago.com | Web: www.wago.com

Do you have any questions about our products?

We are always happy to take your call at +49 (571) 887-44222.



Connection 1

| | |
|---------------------------------|--|
| Connection technology | CAGE CLAMP® |
| Actuation type | Operating tool |
| Connectable conductor materials | Copper |
| Solid conductor | 0.08 ... 2.5 mm ² / 28 ... 12 AWG |
| Fine-stranded conductor | 0.08 ... 2.5 mm ² / 28 ... 12 AWG |
| Note (conductor cross-section) | 12 AWG: THHN, THWN |
| Strip length | 8 ... 9 mm / 0.31 ... 0.35 inches |
| Pole number | 10 |
| Wiring direction | Front-entry wiring |

Physical data

| | |
|-------------------------|-----------------------|
| Width | 116 mm / 4.567 inches |
| Height from the surface | 22.1 mm / 0.87 inches |
| Depth | 32 mm / 1.26 inches |
| Module width | 10 mm / 0.394 inches |

Mechanical Data

| | |
|---------------|-----------------|
| Design | horizontal type |
| Mounting type | Mounting flange |
| Marking level | Center marking |

Material Data

| | |
|-----------------------------|--|
| Note (material data) | Information on material specifications can be found here |
| Color | light gray |
| Material group | I |
| Insulation material | Polyamide (PA66) |
| Flammability class per UL94 | V0 |
| Fire load | 1.196 MJ |
| Halogen-free | Yes |
| Weight | 65.7 g |

Subject to changes. Please also observe the further product documentation!

Commercial data



| | |
|-----------------------|---------------------------|
| Product Group | 9 (Std Chassis Mt Blocks) |
| eCl@ss 10.0 | 27-14-11-06 |
| eCl@ss 9.0 | 27-14-11-06 |
| ETIM 8.0 | EC001284 |
| ETIM 7.0 | EC001284 |
| PU (SPU) | 50 pcs |
| Packaging type | box |
| Country of origin | DE |
| GTIN | 4044918415743 |
| Customs tariff number | 85369010000 |

Environmental Product Compliance

| | |
|------------------------|-------------------------|
| RoHS Compliance Status | Compliant, No Exemption |
|------------------------|-------------------------|

Approvals / Certificates

General approvals

| Logo | Approval | Additional Approval Text | Certificate name |
|--|--------------------------------------|--------------------------|--|
|  | CCC CQST/CNEx | GB/T 3836.3 | 2020312313000187 (Ex eb IIC Gb, Ex eb I Mb) |
|  | CSA DEKRA Certification B.V. | C22.2 | 70010891 |
|  | UR Underwriters Laboratories Inc. | UL 1059 | E45172 |

Approvals for marine applications

| Logo | Approval | Additional Approval Text | Certificate name |
|---|-----------------------|--------------------------|------------------|
|  | LR Lloyds Register | IEC 60998 | LR22173030TA |

Subject to changes. Please also observe the further product documentation!

WAGO GmbH & Co. KG
 Hansastr. 27
 32423 Minden
 Phone: +49571 887-0 | Fax: +49571 887-169
 Email: info.de@wago.com | Web: www.wago.com



Do you have any questions about our products?
 We are always happy to take your call at +49 (571) 887-44222.

Approvals for hazardous areas

| Logo | Approval | Additional Approval Text | Certificate name |
|--|---|--------------------------|---|
|  | AEx UL International Germany GmbH c/o Physikalisch Technische Bundesanstalt | UL 60079 | E185892 (AEx eb IIC resp. Ex eb IIC) |
|  | ATEX Physikalisch Technische Bundesanstalt (PTB) | EN 60079 | PTB 98 ATEX 3129 U (II 2 G Ex eb IIC Gb bzw. I M 2 Ex eb I Mb) |
|  | CCC CNEX | GB/T 3836.3 | 202031231000187 (Ex eb IIC Gb, Ex eb I Mb) |
|  | EAC Brjansker Zertifizierungsstelle | TP TC 012/2011 | RU C-DE.AM02.B. 00127/19 (Ex e IIC Gb U) |
|  | IECEX Physikalisch Technische Bundesanstalt (PTB) | IEC 60079 | IECEX PTB 04.0003 U (Ex e IIC Gb and Ex eb I Mb) |
|  | INMETRO TÜV Rheinland do Brasil Ltda. | IEC 60079 | TÜV 12.1299 U |









Optional accessories

Mounting

| | | | |
|--|--|--|--|
| Cover carrier | | | |
|  | Item no.: 709-167 Cover carrier; Type 1; incl. fixing/retaining screws and knurled nut; suitable for 279 to 282 and 880 Series rail-mounted terminal blocks; suitable for 264 Series miniature rail-mounted terminal blocks; suitable for 270 Series sensor and actuator terminal blocks; gray | | www.wago.com/709-167 |
| Cover | | | |
|  | Item no.: 709-153 Cover; Type 1; suitable for cover carrier, type 1; 1 m long; transparent | | www.wago.com/709-153 |
| Ferrule | | | |
| Ferrule | | | |
|  | Item no.: 216-101 | | |

Subject to changes. Please also observe the further product documentation!



| | | |
|---|--|--|
| | Ferrule; Sleeve for 0.5 mm ² / AWG 22; uninsulated; electro-tin plated; silver-colored | www.wago.com/216-101 |
|  | Item no.: 216-104 Ferrule; Sleeve for 1.5 mm ² / AWG 16; uninsulated; electro-tin plated; silver-colored | www.wago.com/216-104 |
|  | Item no.: 216-106 Ferrule; Sleeve for 2.5 mm ² / AWG 14; uninsulated; electro-tin plated; silver-colored | www.wago.com/216-106 |
|  | Item no.: 216-102 Ferrule; Sleeve for 0.75 mm ² / AWG 20; uninsulated; electro-tin plated; silver-colored | www.wago.com/216-102 |
|  | Item no.: 216-103 Ferrule; Sleeve for 1 mm ² / AWG 18; uninsulated; electro-tin plated | www.wago.com/216-103 |
|  | Item no.: 216-123 Ferrule; Sleeve for 1 mm ² / AWG 18; uninsulated; electro-tin plated; silver-colored | www.wago.com/216-123 |
|  | Item no.: 216-122 Ferrule; Sleeve for 0.75 mm ² / AWG 20; uninsulated; electro-tin plated; silver-colored | www.wago.com/216-122 |
|  | Item no.: 216-124 Ferrule; Sleeve for 1.5 mm ² / AWG 16; uninsulated; electro-tin plated | www.wago.com/216-124 |
|  | Item no.: 216-132 Ferrule; Sleeve for 0.34 mm ² / AWG 24; uninsulated; electro-tin plated | www.wago.com/216-132 |
|  | Item no.: 216-121 Ferrule; Sleeve for 0.5 mm ² / AWG 22; uninsulated; electro-tin plated; silver-colored | www.wago.com/216-121 |
|  | Item no.: 216-131 Ferrule; Sleeve for 0.25 mm ² / AWG 24; uninsulated; electro-tin plated; silver-colored | www.wago.com/216-131 |
|  | Item no.: 216-152 Ferrule; Sleeve for 0.34 mm ² / AWG 24; uninsulated; electro-tin plated | www.wago.com/216-152 |
|  | Item no.: 216-203 Ferrule; Sleeve for 1 mm ² / AWG 18; insulated; electro-tin plated; red | www.wago.com/216-203 |
|  | Item no.: 216-206 Ferrule; Sleeve for 2.5 mm ² / AWG 14; insulated; electro-tin plated; blue | www.wago.com/216-206 |
|  | Item no.: 216-202 Ferrule; Sleeve for 0.75 mm ² / 18 AWG; insulated; electro-tin plated; gray | www.wago.com/216-202 |
|  | Item no.: 216-151 Ferrule; Sleeve for 0.25 mm ² / AWG 24; uninsulated; electro-tin plated | www.wago.com/216-151 |
|  | Item no.: 216-204 Ferrule; Sleeve for 1.5 mm ² / AWG 16; insulated; electro-tin plated; black | www.wago.com/216-204 |
|  | Item no.: 216-205 Ferrule; Sleeve for 2.08 mm ² / AWG 14; insulated; electro-tin plated; yellow | www.wago.com/216-205 |
|  | Item no.: 216-201 | |

Subject to changes. Please also observe the further product documentation!

Ferrule; Sleeve for 0.5 mm² / 20 AWG; insulated; electro-tin plated; whitewww.wago.com/216-201**Item no.: 216-223**Ferrule; Sleeve for 1 mm² / AWG 18; insulated; electro-tin plated; redwww.wago.com/216-223**Item no.: 216-222**Ferrule; Sleeve for 0.75 mm² / 18 AWG; insulated; electro-tin plated; graywww.wago.com/216-222**Item no.: 216-221**Ferrule; Sleeve for 0.5 mm² / 20 AWG; insulated; electro-tin plated; whitewww.wago.com/216-221**Item no.: 216-224**Ferrule; Sleeve for 1.5 mm² / AWG 16; insulated; electro-tin plated; blackwww.wago.com/216-224**Item no.: 216-321**Ferrule; Sleeve for 0.25 mm² / AWG 24; insulated; electro-tin plated; yellowwww.wago.com/216-321**Item no.: 216-322**Ferrule; Sleeve for 0.34 mm² / 22 AWG; insulated; electro-tin plated; light turquoisewww.wago.com/216-322**Marking accessories**

Marker

**Item no.: 2009-145/000-006**

Mini-WSB Inline; for Smart Printer; 1700 pieces on roll; stretchable 5 - 5.2 mm; plain; snap-on type; blue

www.wago.com/2009-145/000-006**Item no.: 2009-145**

Mini-WSB Inline; for Smart Printer; 1700 pieces on roll; stretchable 5 - 5.2 mm; plain; snap-on type; white

www.wago.com/2009-145**Item no.: 2009-145/000-002**

Mini-WSB Inline; for Smart Printer; 1700 pieces on roll; stretchable 5 - 5.2 mm; plain; snap-on type; yellow

www.wago.com/2009-145/000-002**Item no.: 2009-145/000-007**

Mini-WSB Inline; for Smart Printer; 1700 pieces on roll; stretchable 5 - 5.2 mm; plain; snap-on type; gray

www.wago.com/2009-145/000-007**Item no.: 2009-145/000-005**

Mini-WSB Inline; for Smart Printer; 1700 pieces on roll; stretchable 5 - 5.2 mm; plain; snap-on type; red

www.wago.com/2009-145/000-005**Item no.: 2009-145/000-012**

Mini-WSB Inline; for Smart Printer; 1700 pieces on roll; stretchable 5 - 5.2 mm; plain; snap-on type; orange

www.wago.com/2009-145/000-012**Item no.: 2009-145/000-023**

Mini-WSB Inline; for Smart Printer; 1700 pieces on roll; stretchable 5 - 5.2 mm; plain; snap-on type; green

www.wago.com/2009-145/000-023**Item no.: 2009-145/000-024**

Subject to changes. Please also observe the further product documentation!

WAGO GmbH & Co. KG

Hansastr. 27







32423 Minden

Phone: +49571 887-0 | Fax: +49571 887-169

Email: info.de@wago.com | Web: www.wago.com



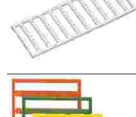
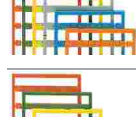
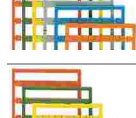
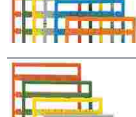
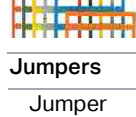

Do you have any questions about our products?

We are always happy to take your call at +49 (571) 887-44222.

| | | |
|--|---|--|
|  | Mini-WSB Inline; for Smart Printer; 1700 pieces on roll; stretchable 5 - 5.2 mm; plain; snap-on type; violet | www.wago.com/2009-145/000-024 |
|  | Item no.: 248-501/000-006 Mini-WSB marking card; as card; not stretchable; plain; snap-on type; blue | www.wago.com/248-501/000-006 |
|  | Item no.: 248-501/000-007 Mini-WSB marking card; as card; not stretchable; plain; snap-on type; gray | www.wago.com/248-501/000-007 |
|  | Item no.: 248-501/000-002 Mini-WSB marking card; as card; not stretchable; plain; snap-on type; yellow | www.wago.com/248-501/000-002 |
|  | Item no.: 248-501/000-012 Mini-WSB marking card; as card; not stretchable; plain; snap-on type; orange | www.wago.com/248-501/000-012 |
|  | Item no.: 248-501 Mini-WSB marking card; as card; not stretchable; plain; snap-on type; white | www.wago.com/248-501 |
|  | Item no.: 248-501/000-017 Mini-WSB marking card; as card; not stretchable; plain; snap-on type; light green | www.wago.com/248-501/000-017 |
|  | Item no.: 248-501/000-005 Mini-WSB marking card; as card; not stretchable; plain; snap-on type; red | www.wago.com/248-501/000-005 |
|  | Item no.: 248-501/000-024 Mini-WSB marking card; as card; not stretchable; plain; snap-on type; violet | www.wago.com/248-501/000-024 |
|  | Item no.: 248-501/000-023 Mini-WSB marking card; as card; not stretchable; plain; snap-on type; green | www.wago.com/248-501/000-023 |
| Jumpers | | |
| Jumper | | |
|  | Item no.: 280-492 Jumper; 2-way; insulated; gray | www.wago.com/280-492 |
|  | Item no.: 264-402 Jumper; for conductor entry; 2-way; insulated; gray | www.wago.com/264-402 |

Subject to changes. Please also observe the further product documentation!

Tool

| Operating tool | | |
|--|---|--|
|  | Item no.: 209-130 Operating tool; made of insulating material; 1-way; for 264 Series (1-/2-way), 280, 281 Series (up to 3-way); natural | www.wago.com/209-130 |
|  | Item no.: 210-657 Operating tool; Blade: 3.5 x 0.5 mm; with a partially insulated shaft; short; multicoloured | www.wago.com/210-657 |
|  | Item no.: 210-658 Operating tool; Blade: 3.5 x 0.5 mm; with a partially insulated shaft; angled; short; multicoloured | www.wago.com/210-658 |
|  | Item no.: 210-720 Operating tool; Blade: 3.5 x 0.5 mm; with a partially insulated shaft; multicoloured | www.wago.com/210-720 |
|  | Item no.: 280-432 Operating tool; made of insulating material; 2-way; white | www.wago.com/280-432 |

Downloads

Documentation

Bid Text

| | | | |
|------------------------|-------------|----------------|----------|
| 264-240 X81 - Datei | 2019 Feb 19 | xml 3.4 kB | Download |
| 264-240 doc - Datei | 2017 Jun 14 | doc 25.6 kB | Download |

Additional Information

| | | |
|---|---------------|----------|
| Technical Section Technical explanations | pdf 2.2 MB | Download |
|---|---------------|----------|

CAD/CAE-Data

CAD data

| | | |
|----------------------|-----|----------|
| 2D/3D Models 264-240 | URL | Download |
|----------------------|-----|----------|

CAE data

| | | |
|---------------------------|-----|----------|
| EPLAN Data Portal 264-240 | URL | Download |
|---------------------------|-----|----------|

Subject to changes. Please also observe the further product documentation!

WAGO GmbH & Co. KG
 Hansastr. 27
 32423 Minden
 Phone: +49571 887-0 | Fax: +49571 887-169
 Email: info.de@wago.com | Web: www.wago.com

Do you have any questions about our products?
 We are always happy to take your call at +49 (571) 887-44222.

WSCAD Universe 264-240

[URL](#)

[Download](#)

ZUKEN Portal 264-240

[URL](#)

[Download](#)

Environmental Product Compliance

Compliance Search

Environmental Product Compliance 264-240

[URL](#)

[Download](#)

4-conductor terminal strip; without push-buttons; suitable for Ex e II applications; with fixing flanges; 10-pole; for screw or similar mounting types; Fixing hole 3.2 mm Ø; 2.5 mm²; CAGE CLAMP®; 2,50 mm²; light gray

Installation Notes

Installation

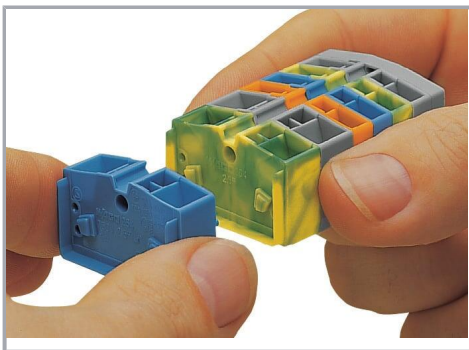

Assembling modular terminal blocks into terminal strips.

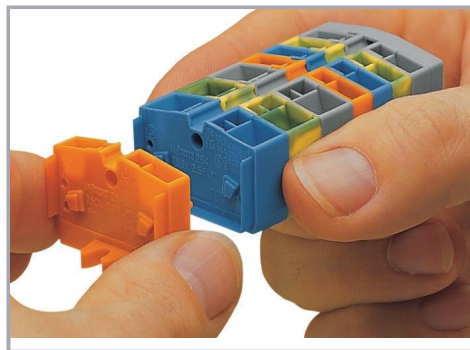

Mounting an "end terminal block" with mounting flange.

Subject to changes. Please also observe the further product documentation!

WAGO GmbH & Co. KG

Hansastr. 27

32423 Minden

Phone: +49571 887-0 | Fax: +49571 887-169

Email: info.de@wago.com | Web: www.wago.com

Do you have any questions about our products?

We are always happy to take your call at +49 (571) 887-44222.

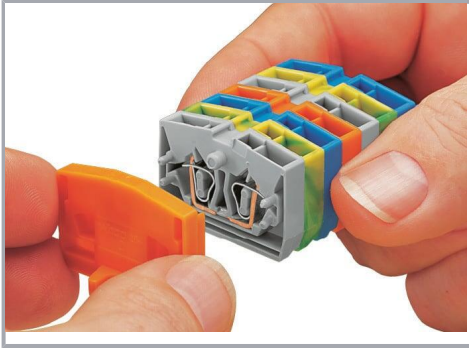

Mounting an end plate.

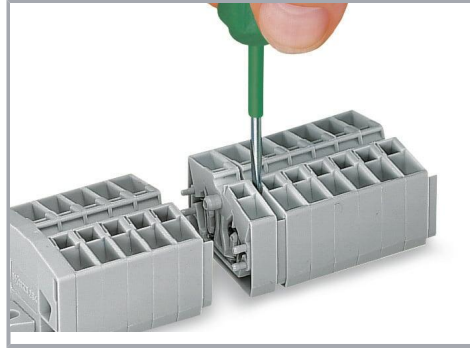

Removing a terminal block.

Conductor termination

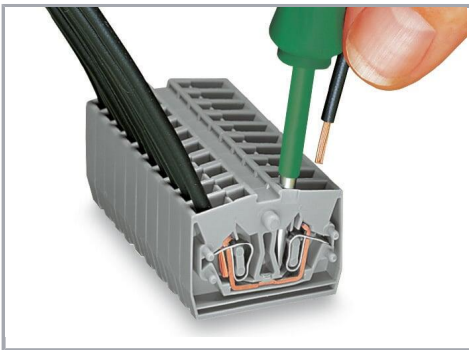

CAGE CLAMP® connection

Inserting a conductor.

With ferruled conductors, it is necessary to use a terminal block one size smaller than the conductor's nominal cross-section.

Commoning

Subject to changes. Please also observe the further product documentation!

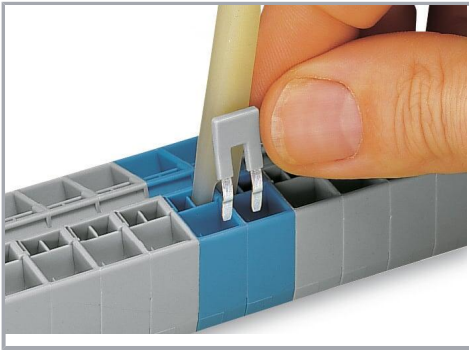

Commoning with comb-style jumper bar.

Testing

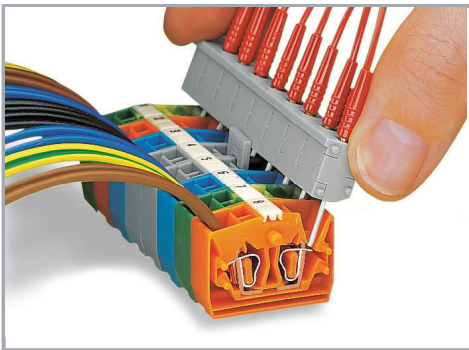

Testing by touch contact to the CAGE CLAMP® spring (limited to 0.5 A and 48 V test voltage) – test pins are not protected against accidental contact.



Testing via CAGE CLAMP® on the current bar (max. nominal current: 6 A).

CAGE CLAMP® clamps individual test contacts.

The maximum test voltage is 400 V.

Marking

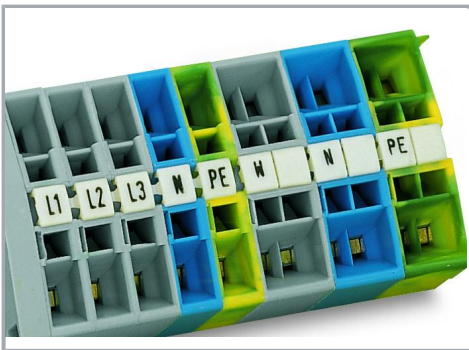

Marking via Mini-WSB Quick Marking System.

Subject to changes. Please also observe the further product documentation!