

THIS DOCUMENT IS SUBJECT TO CHANGE WITHOUT NOTICE. IT IS CONFIDENTIAL AND A PROPERTY OF Amphenol LTW. DISCLOSURE TO THIRD PARTY HAS TO BE AUTHORIZED BY Amphenol LTW.

REV.	ECN NO.	DATE	SIGN	DESCRIPTION
A		2022-01-21	Jiahe Lin	Rev.01 To Rev.A

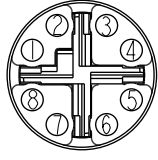

8P

Pin Assignments  
Front View

MSXS-XXPFFR-EE0002

XX: No. Of Pin

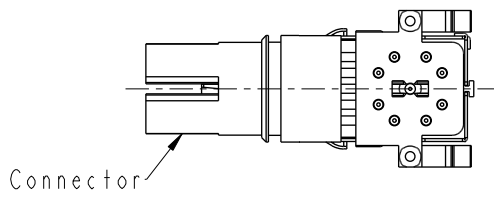
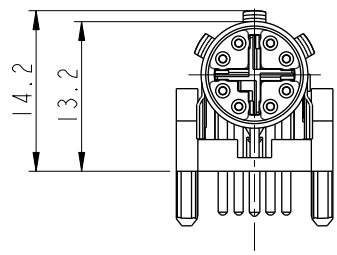
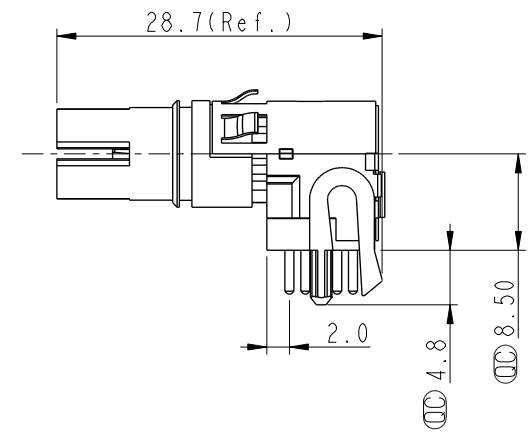
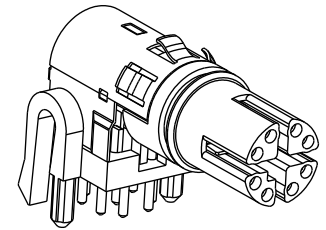
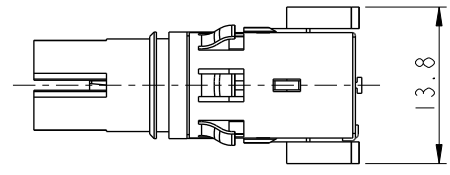

Note:  
 \* RoHS Compliant  
 \*  $\varnothing$  Important dimension  
 \* Waterproof rate: Non-Waterproof  
 \* Connector  
 Housing: Thermoplastic, Black  
 Pin: Copper alloy, Gold plated  
 \* For pcb thickness: 1.6~2.4mm

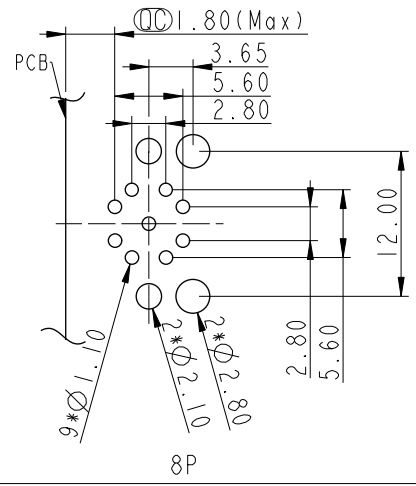

PCB Layout

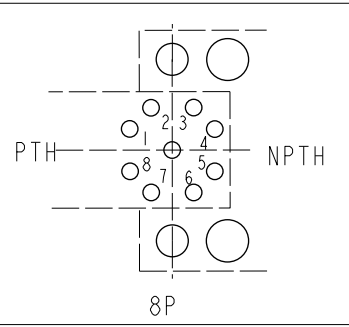

Pin Definition

UNIT: mm	$\varnothing$	$\nabla$
TOLERANCE	.X	$\pm 0.25$
	.XX	$\pm 0.1$
	.XXX	$\pm 0.05$
ANGLES		$\pm 1^\circ$

TITLE N SEN, M12 X -SHLD, RECEPTACLE, F, F, PCB R		
SCALE 3:2	SIZE A4	SHEET 1 OF 1
REV. A	WC-REV. A.1	$\varnothing$ : Inspection item

**Amphenol LTW**  
 安費諾亮泰企業股份有限公司

ITEM NO	DRAWN BY Jiahe Lin	DATE 2022-01-21
DWG NO MSXS-XXPFFR-EE0002	CHECKED BY Allen Pan	DATE 2022-01-21
CUSTOMER ALTW	APPROVED BY Fred Lee	DATE 2022-01-21