

## Data sheet | Item number: 890-135

Plug; with strain relief housing; 5-pole; 1,50 mm<sup>2</sup>; white

[www.wago.com/890-135](http://www.wago.com/890-135)

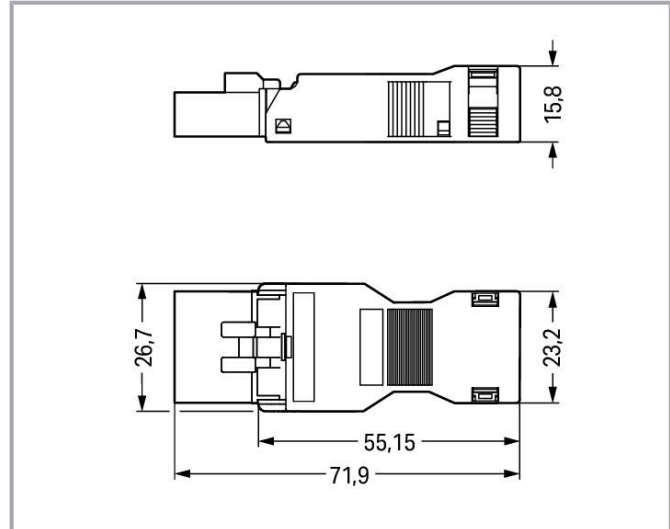
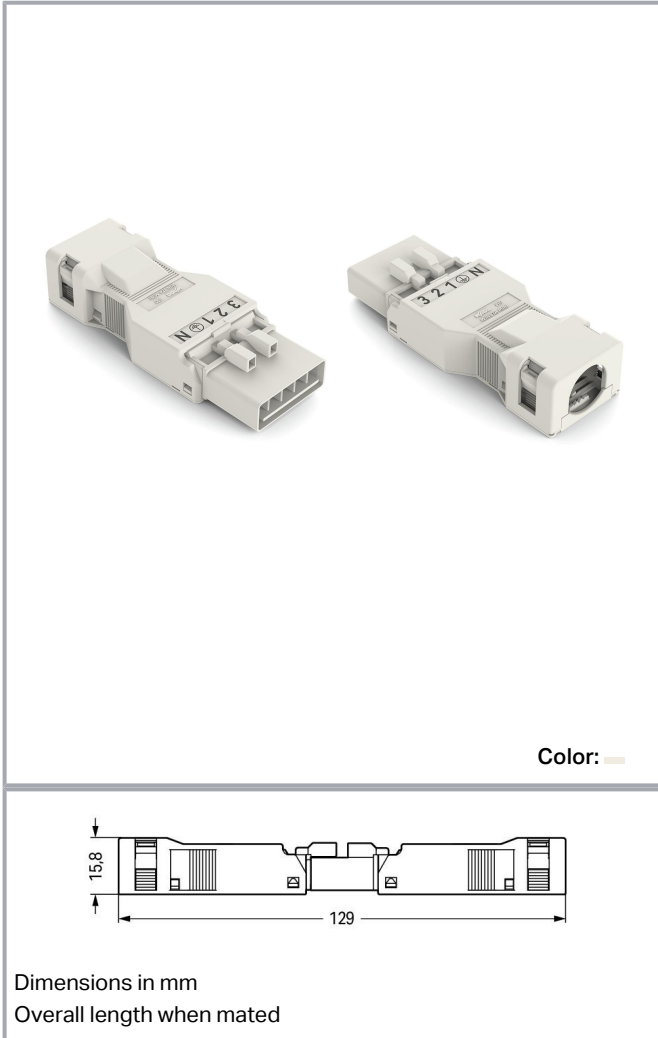

### Item description

#### Male connector/plug *WINSTA*® MINI with protection against mismatching

The *WINSTA*® MINI male connector/plug with protection type IP40 provides the foundation for assembly of fine-stranded and solid conductors. WAGO pluggable installation connectors can be used when requirements repeat or are planned on a defined pattern, for example for installing grid

Subject to changes. Please also observe the further product documentation!

WAGO GmbH & Co. KG  
Hansastr. 27  
32423 Minden  
Phone: +49571 887-0 | Fax: +49571 887-169  
Email: [info.de@wago.com](mailto:info.de@wago.com) | Web: [www.wago.com](http://www.wago.com)

Do you have any questions about our products?  
We are always happy to take your call at +49 (571) 887-44222.



lighting or flush-mount lighting. For greater protection in electrical installations, the pluggable installation connector is equipped with mechanical protection against mismatching. The pluggable installation connector offers protection against contact with wires or tools if they are smaller than 1 mm in accordance with protection type IP40. The *WINSTA*® MINI pluggable installation connector with A coding in black or white is usually used for general mains applications in power distribution. Particularly where space is tight, our smallest pluggable connection system, *WINSTA*® MINI, conveniently displays its strengths. It is very compact, and, thanks to Push-in CAGE CLAMP® spring pressure connection technology, it additionally saves time, since the installation is low-maintenance and requires no screw connections. The strip length is 45 mm.

## *WINSTA*® MINI solutions for your electrical installation – protected against mismatching and maintenance-free

*WINSTA*® is the pluggable connection system that is perfectly tailored to the strict requirements of electrical installation. It ensures fast, secure and, above all, error-free installation of components and cables. Now you can also reduce installation costs without compromising safety and quality. The *WINSTA*® MINI pluggable installation connector with marking eliminates the need for servicing and prevents unnecessary downtime.

- effective protection against mismatching
- easy tool-free operation, a wide range of coding options
- suitable for any application
- custom-engineered solutions
- fast, secure installation

## Data

### Electrical data

#### Ratings per IEC/EN

Ratings per	IEC/EN 60664-1
Nominal voltage (III/3)	400 V
Rated impulse voltage (III/3)	6 kV
Rated current	13 A
Legend (ratings)	(III / 3) ≙ Overvoltage category III / Pollution degree 3

#### Ratings per UL 1977

Note for the US market	Some versions may also be used for current interruption in accordance with the UL certificate in select applications with currents below 5 A and voltages up to 600 V. For further information, please contact your local sales office.
Rated voltage (UL 1977)	600 V
Rated current UL 1977	12 A

Subject to changes. Please also observe the further product documentation!



## General

Note on contact resistance	approx. 1 mΩ of contact resistance approx. 0.25 mΩ contact transition plug/socket
----------------------------	--

## Connection data

Connection points	5
Total number of potentials	5

## Connection 1

Connection technology	Push-in CAGE CLAMP®
Actuation type	Operating tool Push-in
Nominal cross-section	1.5 mm <sup>2</sup> / 16 AWG
Solid conductor	0.25 ... 1.5 mm <sup>2</sup> / 22 ... 16 AWG
Solid conductor; push-in termination	0.75 ... 1.5 mm <sup>2</sup> / 20 ... 16 AWG
Stranded conductor	0.25 ... 1 mm <sup>2</sup> / 22 ... 18 AWG
Fine-stranded conductor	0.25 ... 1.5 mm <sup>2</sup> / 22 ... 16 AWG
Fine-stranded conductor; with insulated ferrule	0.25 ... 0.75 mm <sup>2</sup> / 22 ... 20 AWG
Fine-stranded conductor; with uninsulated ferrule	0.25 ... 0.75 mm <sup>2</sup> / 22 ... 20 AWG
Fine-stranded conductor; with ferrule; push-in termination	0.75 mm <sup>2</sup> / 20 AWG
Strip length	9 mm / 0.35 inches
Pole number	5
Conductor entry direction to mating direction	0°
Strip length (outer insulation)	45 mm

## Physical data

Pin spacing	4.4 mm / 0.173 inches
Width	26.7 mm / 1.051 inches
Height	15.8 mm / 0.622 inches
Depth	71.9 mm / 2.831 inches

## Mechanical Data

Application	General mains applications
Coding	A
Variable coding	No
Marking	3 2 1 $\frac{1}{2}$ N

Subject to changes. Please also observe the further product documentation!



Potential marking	3 2 1 ⚡ N
Mating force of a plug-in connection	approx. 20 ... 70 N (depending on pole number)
Retention force of a plug-in connection	Locked: > 80 N
Unmating force of a plug-in connection	Unlocked: approx. 20 ... 70 N (depending on pole number)
Number of mating cycles	200, without resistive load
Protection type	IP40

## Plug-in connection

Contact type (pluggable connector)	Male connector/plug
Connector (connection type)	for conductor
Mismating protection	Yes
Note on mismating protection	All WINSTA <sup>®</sup> components are 100% protected against mismating when: a.) plugging different numbers of poles b.) plugging while rotated 180 c.) plugging while laterally staggered d.) plugging one pole
Locking lever	Can be retrofitted
Locking of plug-in connection	locking lever
Note on locking system	All connectors for mounted installations (snap-in versions for lighting fixtures or devices, all types of PCB and distribution connectors) are factory-equipped with locking levers to ensure plugs and sockets are securely locked. Additional locking levers are only required for flying leads (plug/socket).
Strain relief	strain relief housing

## Material Data

Note (material data)	Information on material specifications can be found here
Color	white
Cover color	gray
Material group	I
Insulation material	Polyamide (PA66)
Flammability class per UL94	V0
Clamping spring material	Chrome-nickel spring steel (CrNi)
Contact material	Copper or copper alloy; surface-treated
Contact plating	Tin
Fire load	0.352 MJ

Subject to changes. Please also observe the further product documentation!

Weight	11.7 g
--------	--------

### Environmental requirements

Processing temperature	-5 ... +40 °C
Continuous operating temperature	-35 ... +85 °C
Note on continuous operating temperature	Insulating parts for temperatures ≤ 105 °C

### Commercial data



Product Group	20 (Winsta)
eCl@ss 10.0	27-44-06-05
eCl@ss 9.0	27-44-06-05
ETIM 8.0	EC002560
ETIM 7.0	EC002560
PU (SPU)	50 pcs
Packaging type	box
Country of origin	DE
GTIN	4045454233037
Customs tariff number	85366990990

### Environmental Product Compliance

RoHS Compliance Status	Compliant, No Exemption
------------------------	-------------------------

### Approvals / Certificates

#### General approvals

Logo	Approval	Additional Approval Text	Certificate name
	CCA DEKRA Certification B.V.	IEC 61535	NL-85020
	CCA DEKRA Certification B.V.	EN 61535	71- 123231
	cURus Underwriters Laboratories Inc.	UL 1977	E45171



### Declarations of conformity and manufacturer's declarations

Certificate



Subject to changes. Please also observe the further product documentation!

WAGO GmbH & Co. KG  
 Hansastr. 27  
 32423 Minden  
 Phone: +49571 887-0 | Fax: +49571 887-169  
 Email: [info.de@wago.com](mailto:info.de@wago.com) | Web: [www.wago.com](http://www.wago.com)





Do you have any questions about our products?  
 We are always happy to take your call at +49 (571) 887-44222.

Logo	Approval	Additional Approval Text	name
	EU-Declaration of Conformity WAGO GmbH & Co. KG	-	-
	UK-Declaration of Conformity WAGO GmbH & Co. KG	-	-

### Approvals for marine applications

Logo	Approval	Additional Approval Text	Certificate name
	ABS American Bureau of Shipping	Steel Vessel Rules	19- HG1869855- PDA
	DNV GL Det Norske Veritas, Germanischer Lloyd	-	TAE00001Z6
	LR Lloyds Register	EN 61535	08/20047 (E2)

### Counterpart

	<b>Item no.890-125</b> Socket; with strain relief housing; 5-pole; Cod. A; 1,50 mm <sup>2</sup> ; white	<a href="http://www.wago.com/890-125">www.wago.com/890-125</a>
	<b>Item no.890-225</b> Socket; 5-pole; Cod. A; 1,50 mm <sup>2</sup> ; white	<a href="http://www.wago.com/890-225">www.wago.com/890-225</a>
	<b>Item no.890-671</b> T-distribution connector; 5-pole; Cod. A; 1 input; 2 outputs; 2 locking levers; white	<a href="http://www.wago.com/890-671">www.wago.com/890-671</a>
	<b>Item no.890-725</b> Snap-in socket; 5-pole; Cod. A; 1,50 mm <sup>2</sup> ; white	<a href="http://www.wago.com/890-725">www.wago.com/890-725</a>

Subject to changes. Please also observe the further product documentation!

WAGO GmbH & Co. KG  
Hansastr. 27  
32423 Minden  
Phone: +49571 887-0 | Fax: +49571 887-169  
Email: [info.de@wago.com](mailto:info.de@wago.com) | Web: [www.wago.com](http://www.wago.com)

Do you have any questions about our products?  
We are always happy to take your call at +49 (571) 887-44222.



**Item no. 890-725/006-000**  
Snap-in socket; without locking lever; 5-pole; Cod. A; 1,50 mm<sup>2</sup>; white

[www.wago.com/890-725/006-000](http://www.wago.com/890-725/006-000)



**Item no. 890-825**  
Socket for PCBs; straight; 5-pole; Cod. A; white

[www.wago.com/890-825](http://www.wago.com/890-825)



**Item no. 890-825/011-000**  
Socket for PCBs; angled; 5-pole; Cod. A; white

[www.wago.com/890-825/011-000](http://www.wago.com/890-825/011-000)



**Item no. 890-979**  
h-distribution connector; 5-pole; Cod. A; 1 input; 2 outputs; outputs on one side; 2 locking levers; white

[www.wago.com/890-979](http://www.wago.com/890-979)



**Item no. 890-980**  
h-distribution connector; 5-pole; Cod. A; 1 input; 2 outputs; outputs on one side; 3 locking levers; for flying leads; white

[www.wago.com/890-980](http://www.wago.com/890-980)



**Item no. 890-672**  
T-distribution connector; 5-pole; Cod. A; 1 input; 2 outputs; 3 locking levers; for flying leads; white

[www.wago.com/890-672](http://www.wago.com/890-672)



**Item no. 891-8995/106-102**  
pre-assembled connecting cable; Eca; Socket/open-ended; 5-pole; Cod. A; H05VV-F 5G 1.5 mm<sup>2</sup>; 1 m; 1,50 mm<sup>2</sup>; white

[www.wago.com/891-8995/106-102](http://www.wago.com/891-8995/106-102)



**Item no. 891-8995/006-102**  
pre-assembled interconnecting cable; Eca; Socket/plug; 5-pole; Cod. A; H05VV-F 5G 1.5 mm<sup>2</sup>; 1 m; 1,50 mm<sup>2</sup>; white

[www.wago.com/891-8995/006-102](http://www.wago.com/891-8995/006-102)

## Required accessories

### Locking levers

#### Locking system



**Item no.: 890-111**  
Locking lever; for flying leads; for tool operation; black

[www.wago.com/890-111](http://www.wago.com/890-111)



**Item no.: 890-101**  
Locking lever; for manual operation; black

[www.wago.com/890-101](http://www.wago.com/890-101)



**Item no.: 890-121**  
Locking lever; for manual operation; white

[www.wago.com/890-121](http://www.wago.com/890-121)



**Item no.: 890-131**  
Locking lever; for flying leads; for tool operation; white

[www.wago.com/890-131](http://www.wago.com/890-131)

Subject to changes. Please also observe the further product documentation!

## Optional accessories

### Cover

Cover



**Item no.: 897-2003**  
Protective cap; Type2; for sockets and plugs; PVC; red

[www.wago.com/897-2003](http://www.wago.com/897-2003)

### Mounting

Mounting accessories



**Item no.: 890-310**  
Mounting carrier; 2- to 5-pole; for flying leads; black

[www.wago.com/890-310](http://www.wago.com/890-310)



**Item no.: 890-311**  
Mounting carrier; 2- to 5-pole; for flying leads; white

[www.wago.com/890-311](http://www.wago.com/890-311)

### Tool

Operating tool



**Item no.: 210-719**  
Operating tool; Blade: 2.5 x 0.4 mm; with a partially insulated shaft

[www.wago.com/210-719](http://www.wago.com/210-719)



**Item no.: 890-385**  
Operating tool; 5-way; green

[www.wago.com/890-385](http://www.wago.com/890-385)

### Shield termination

Shield termination



**Item no.: 890-527**  
Shield connecting plate; 5-pole; for plugs

[www.wago.com/890-527](http://www.wago.com/890-527)

## Downloads

### Documentation

#### Bid Text

890-135 X81 - Datei	2019 Feb 19	xml 3.1 kB	Download
890-135 doc - Datei	2015 Jun 8	doc 24.1 kB	Download

### CAD/CAE-Data

Subject to changes. Please also observe the further product documentation!

WAGO GmbH & Co. KG  
Hansastr. 27  
32423 Minden  
Phone: +49571 887-0 | Fax: +49571 887-169  
Email: [info.de@wago.com](mailto:info.de@wago.com) | Web: [www.wago.com](http://www.wago.com)

Do you have any questions about our products?  
We are always happy to take your call at +49 (571) 887-44222.



### CAE data

WSCAD Universe 890-135	<a href="#">URL</a>	<a href="#">Download</a>
------------------------	---------------------	--------------------------

ZUKEN Portal 890-135	<a href="#">URL</a>	<a href="#">Download</a>
----------------------	---------------------	--------------------------

### CAD data

2D/3D Models 890-135	<a href="#">URL</a>	<a href="#">Download</a>
----------------------	---------------------	--------------------------

## Environmental Product Compliance

### Compliance Search

Environmental Product Compliance 890-135	<a href="#">URL</a>	<a href="#">Download</a>
--	---------------------	--------------------------

Plug; with strain relief housing; 5-pole; 1,50 mm<sup>2</sup>; white

## Installation Notes

### Conductor termination

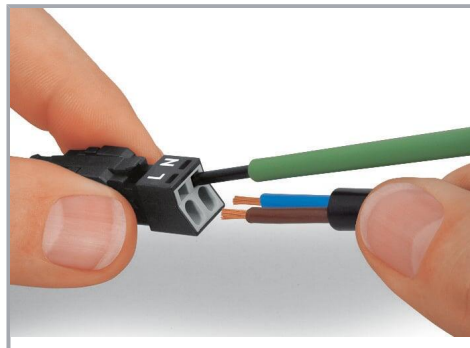
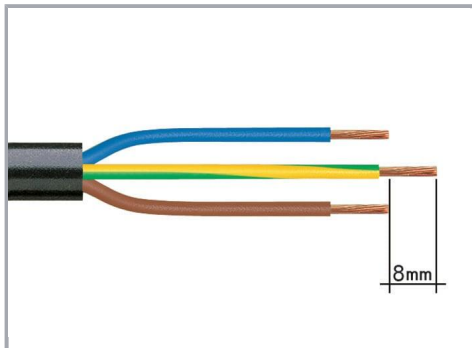

1. Strip length, outer insulation = 30 mm (2-pole), 37 mm (3-pole), 45 mm (4- and 5-pole)

2. Strip length = 9 mm

3. Extended ground conductor = 8 mm

To terminate fine-stranded conductors, open the clamping unit via screwdriver – 2.5 mm blade width – and insert a stripped conductor until it hits the backstop.

Terminate solid conductors by simply pushing them in.

Subject to changes. Please also observe the further product documentation!

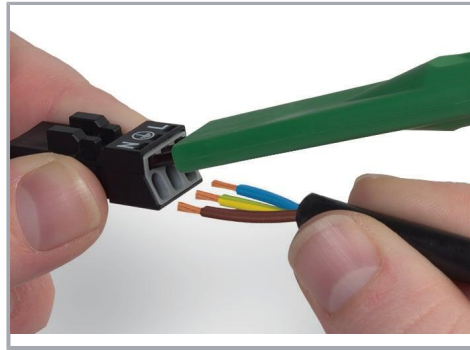
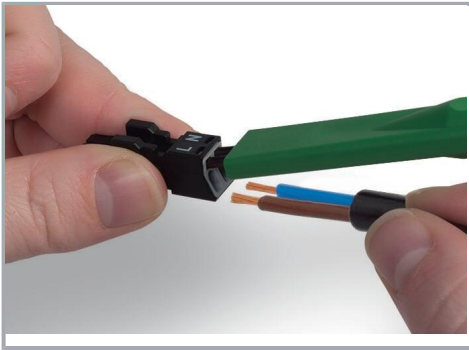

To terminate fine-stranded conductors, open clamping units via operating tool (890-382) and insert stripped conductors until they hit backstop.

To terminate fine-stranded conductors, open clamping units via operating tool (890-383) and insert stripped conductors until they hit backstop.

Terminate solid conductors by simply pushing them in.

Terminate solid conductors by simply pushing them in.

#### Installation

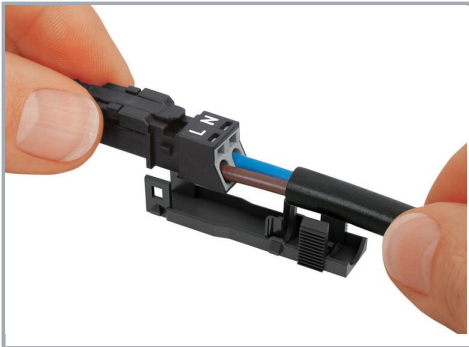

Latch the wired connector into the base of the strain relief housing.

Push down strain relief clamp by hand.

Subject to changes. Please also observe the further product documentation!



Push down strain relief clamp with 2.5 mm screwdriver alternately on both sides.

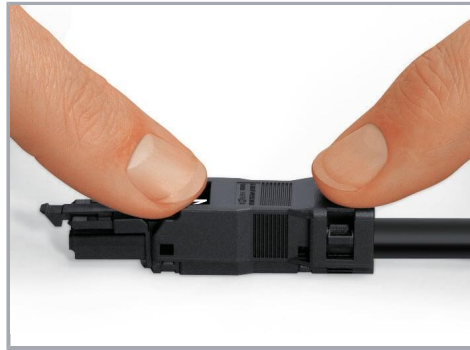

Latch the top of the strain relief housing.



The printed marking of the connector is clearly visible in the openings of the strain relief housing.

#### Shield termination



Connector with shield termination

Subject to changes. Please also observe the further product documentation!



Apply the shield to the sheathed cable.

Strip length, outer insulation = 30 mm

Shield length = 8 mm



Push the shield connecting plate into the connector until fully inserted.

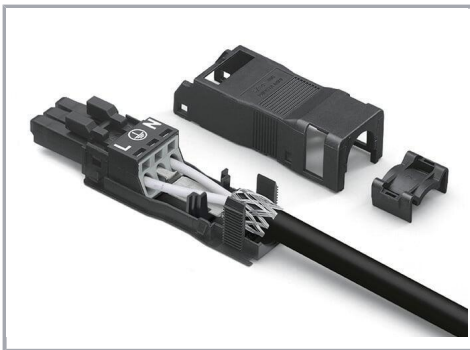

First insert the wired connector into strain relief housing, then snap clamp and cover.

## Product family

**WINSTA® MINI**

[Show all products from the family](#)

Subject to changes. Please also observe the further product documentation!