

Power connector - SACC-M12MR-4CON-PG11-M PWR - 1408990

Please be informed that the data shown in this PDF Document is generated from our Online Catalog. Please find the complete data in the user's documentation. Our General Terms of Use for Downloads are valid (<http://phoenixcontact.com/download>)

Power connector, 4-position, Plug angled M12, Coding: A, Screw connection, knurl material: Zinc die-cast, nickel-plated, cable gland Pg11, external cable diameter 8 mm ... 10 mm



Your advantages

- Safe use in the field, thanks to a high degree of protection
- Screw connection: proven connection technology for a large selection of different conductors



Key Commercial Data

Packing unit	1 pc
GTIN	 4 046356 885102
GTIN	4046356885102

Technical data

Dimensions

Diameter housing	20.2 mm
Length	44 mm
External cable diameter	8 mm ... 10 mm
Stripping length of the sheath	20 mm
Stripping length of the individual wire	5 mm

Ambient conditions

Ambient temperature (operation)	-40 °C ... 85 °C (Plug / socket)
	-40 °C ... 85 °C (Plug / socket)
Degree of protection	IP67

General

Note	Strip 22 mm off the cable sheath, strip 7 mm off the conductor insulation, crimp the ferrule, then shorten this to 5 mm. Length of conductor with shortened ferrule: 20 mm. Connect conductors and tighten the mounting screws with 0.2 Nm.
------	---

Power connector - SACC-M12MR-4CON-PG11-M PWR - 1408990

Technical data

General

	NOTE: Observe the permissible bending radii when laying conductors, since the degree of protection may be put in jeopardy if the bending forces are too high. Alleviate mechanical loads upstream of the connector, e.g. by using cable ties.
Rated current at 40°C	8 A (when using 1.5 mm ² conductors)
Rated voltage	250 V AC
	250 V DC
Number of positions	4
Color handle area	black
Insulation resistance	> 10 GΩ
Coding	A - standard
Standards/regulations	M12 connector IEC 61076-2-101
Status display	No
Overvoltage category	II
Degree of pollution	3
Connection method	Screw connection
Conductor cross section	0.75 mm ² ... 1.5 mm ² (without ferrule)
	0.75 mm ² ... 1.5 mm ² (with ferrule)
	0.75 mm ² ... 1.5 mm ² (solid)
Conductor cross section AWG	18 ... 16 (without ferrule)
	16 ... 18 (with ferrule)
Insertion/withdrawal cycles	> 100
Torque	0.4 Nm (M12 knurl)
	1.5 Nm ... 2 Nm (Pressure screw with sleeve housing)
	0.4 Nm (Screw plug insert with sleeve housing as far it will go)
	0.2 Nm (Screw terminal blocks)
Assembly instructions	The connector pin assignment can be rotated 90° to the cable outlet

Material

Flammability rating according to UL 94	V0
Contact material	CuZn
Contact surface material	Ni/Au
Contact carrier material	PA
Material of grip body	PA
Material, knurls	Zinc die-cast, nickel-plated
Sealing material	NBR (Cable clamping)

Standards and Regulations

Standards/specifications	M12 connector IEC 61076-2-101
Flammability rating according to UL 94	V0
Standards/specifications	M12 connector IEC 61076-2-101

Environmental Product Compliance

Power connector - SACC-M12MR-4CON-PG11-M PWR - 1408990

Technical data

Environmental Product Compliance

REACH SVHC	Lead 7439-92-1
China RoHS	Environmentally Friendly Use Period = 50 years
	For details about hazardous substances go to tab "Downloads", Category "Manufacturer's declaration"

Drawings

Schematic diagram

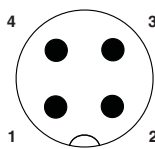

Pin assignment M12 plug, 4-pos., A-coded, view plug side

Dimensional drawing

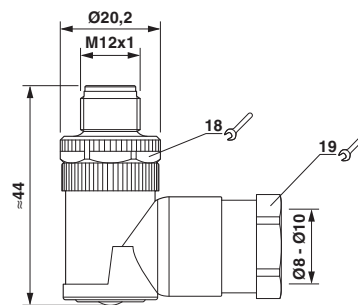

M12 x 1 male plug, angled

Classifications

eCl@ss

eCl@ss 10.0.1	27440102
eCl@ss 11.0	27440102
eCl@ss 4.0	27140800
eCl@ss 4.1	27140800
eCl@ss 5.0	27143400
eCl@ss 5.1	27143400
eCl@ss 6.0	27279200
eCl@ss 7.0	27440104
eCl@ss 9.0	27440102

ETIM

ETIM 4.0	EC002062
ETIM 6.0	EC002062
ETIM 7.0	EC002635

UNSPSC

UNSPSC 6.01	31251501
UNSPSC 7.0901	31251501
UNSPSC 11	31251501
UNSPSC 12.01	31251501

Power connector - SACC-M12MR-4CON-PG11-M PWR - 1408990

Classifications

UNSPSC

UNSPSC 13.2	39121413
UNSPSC 18.0	39121413
UNSPSC 19.0	39121413
UNSPSC 20.0	39121413
UNSPSC 21.0	39121413

Approvals

Approvals

Approvals

UL Recognized / cUL Recognized / EAC / cULus Recognized

Ex Approvals

Approval details

UL Recognized		http://database.ul.com/cgi-bin/XYV/template/LISEXT/1FRAME/index.htm	FILE E 221474
Nominal voltage UN		250 V	
Nominal current IN		4 A	

cUL Recognized		http://database.ul.com/cgi-bin/XYV/template/LISEXT/1FRAME/index.htm	FILE E 221474
Nominal voltage UN		250 V	
Nominal current IN		4 A	

EAC		RU C- DE.BL08.B.00511
-----	---	--------------------------

cULus Recognized	
------------------	---

Power connector - SACC-M12MR-4CON-PG11-M PWR - 1408990

Accessories

Accessories

Cable end sleeve

Ferrule - A 1,5 - 7 - 3200263



Ferrule, length: 7 mm, color: silver

Crimping tool

Crimping pliers - CRIMPFOX 6H - 1212046



Crimping pliers, for ferrules without insulating collar according to DIN 46228 Part 1 and ferrules with insulating collar according to DIN 46228 Part 4, 0.14 mm² ... 6 mm², unlockable pressure lock, lateral entry

Protective cap

Sealing cap - PROT-M12 FS-PA-CHAIN - 1430873

M12 sealing cap made of plastic with fixing band, for sensor cables, for free M12 plugs



Screwdriver tools

Adapter insert - TSD-M SAC-BIT ADAPTER - 1212600



Adapter bit for TSD-M...torque tools, E6.3-1/4" drive with 4 mm hexagon to accommodate SAC bits

Tool - SACC BIT M12-D20 - 1208445



Nut for assembling M12 connectors for assembly with a knurl diameter of 20 mm, for 4 mm hexagonal drive

Power connector - SACC-M12MR-4CON-PG11-M PWR - 1408990

Accessories

Screwdriver - SZF 1-0,6X3,5 - 1204517



Actuation tool, for ST terminal blocks, also suitable for use as a bladed screwdriver, size: 0.6 x 3.5 x 100 mm, 2-component grip, with non-slip grip

Stripping tool

Stripping tool - WIREFOX 6SC - 1212158



Stripping tool, for cables and conductors (especially for cables protected against short circuits and ground leakages) 1.5 - 6 mm², self-adjusting, stripping length of up to 18 mm, cutting capacity of up to 10 mm² stranded/1.5 mm² solid, replaceable stripping blade

Torque tool

Torque screwdriver - TSD 04 SAC - 1208429



Torque screwdriver, with preset torque of 0.4 Nm and 4 mm hexagonal drive for M12 connectors

Torque screwdriver - TSD-M 1,2NM - 1212224



Torque screw driver, accuracy as per EN ISO 6789 standard, adjustable from 0.3 - 1.2 Nm