

## Sensor/actuator cable - SAC-5P- 5,0-PUO/AD-2L OD - 1407293

Please be informed that the data shown in this PDF Document is generated from our Online Catalog. Please find the complete data in the user's documentation. Our General Terms of Use for Downloads are valid (<http://phoenixcontact.com/download>)



Sensor/actuator cable, 5-position, PUR halogen-free, black RAL 9005, free cable end, on Valve connector AD (pressure switch), with 2 LEDs, cable length: 5 m, for outdoor applications, With stainless steel central screw and additional silicone seal (red)

### Your advantages

- ✓ Easy and safe: 100% electrically tested plug-in components
- ✓ Robust valve connector without protective circuit
- ✓ Corrosion protection for all exposed metal parts, thanks to the use of stainless steel type 1.4404
- ✓ Robust throughout: resistant to oil, UV, and ozone, withstands temperatures from -20°C to +85°C

### Key Commercial Data

Packing unit	1 pc
GTIN	 4 046356 774116
GTIN	4046356774116

### Technical data

#### Dimensions

Length of cable	5 m
Central screw valve connector	M3 x 29

#### Ambient conditions

Ambient temperature (operation)	-40 °C ... 85 °C (valve plug)
Degree of protection	IP65/IP67

#### General

Rated current at 40°C	4 A
Rated voltage	24 V AC
	24 V DC
Number of positions	5
Color handle area	black

# Sensor/actuator cable - SAC-5P- 5,0-PUO/AD-2L OD - 1407293

## Technical data

### General

Insulation resistance	≥ 100 MΩ
Standards/regulations	Valve connector EN 175301-803
Status display	2 LEDs
Protective circuit/component	unwired
Overvoltage category	III
Degree of pollution	3
Torque	0.6 Nm ... 0.8 Nm (Valve connector)
Tightening torque	0.8 Nm for IP66K

### Material

Flammability rating according to UL 94	V0
Valve plug contact material	CuSn
Valve plug contact surface material	Sn
Valve plug contact insert material	PA 6
Material housing valve plug	TPU
Sealing material	TPU (Seal molded)
	Silicon (Seal snapped in)

### Standards and Regulations

Standard designation	Valve connector
Standards/regulations	EN 175301-803
Flammability rating according to UL 94	V0

### Cable

Cable type	PUR halogen-free black
Cable type (abbreviation)	PUO
Cable abbreviation	Li9Y11Y
Conductor cross section	5x 0.5 mm <sup>2</sup>
AWG signal line	20
Conductor structure signal line	16x 0.20 mm
Core diameter including insulation	2 mm ±0.05 mm
Wire colors	Black 1, black 2, black 3, black 4, green/yellow
Overall twist	5 cores, twisted
External sheath, color	black RAL 9005
External cable diameter D	6.9 mm ±0.1 mm
Minimum bending radius, fixed installation	10 x D
Minimum bending radius, flexible installation	15 x D
Outer sheath, material	PUR
Material conductor insulation	PP
Conductor material	Tin-plated Cu litz wires
Insulation resistance	70 GΩ*km
Conductor resistance	≤ 40.1 Ω/km

## Sensor/actuator cable - SAC-5P- 5,0-PUO/AD-2L OD - 1407293

### Technical data

#### Cable

Nominal voltage, cable	300 V
Test voltage Core/Core	3000 V (Spark test)
Halogen-free	in accordance with DIN VDE 0472 part 815
	According to EN 50267-2-1
Resistance to oil	According to DIN EN 50306
	According to DIN EN 60811-2-1, 138 h at 100°C
Other resistance	UV resistant
	hydrolysis and microbe resistant
	Good resistance to aggressive media
Ambient temperature (operation)	-40 °C ... 105 °C (cable, fixed installation)
	-15 °C ... 105 °C (cable, flexible installation)

#### Environmental Product Compliance

China RoHS	Environmentally Friendly Use Period = 50
	For details about hazardous substances go to tab "Downloads", Category "Manufacturer's declaration"

#### Drawings

# Sensor/actuator cable - SAC-5P- 5,0-PUO/AD-2L OD - 1407293

Schematic diagram

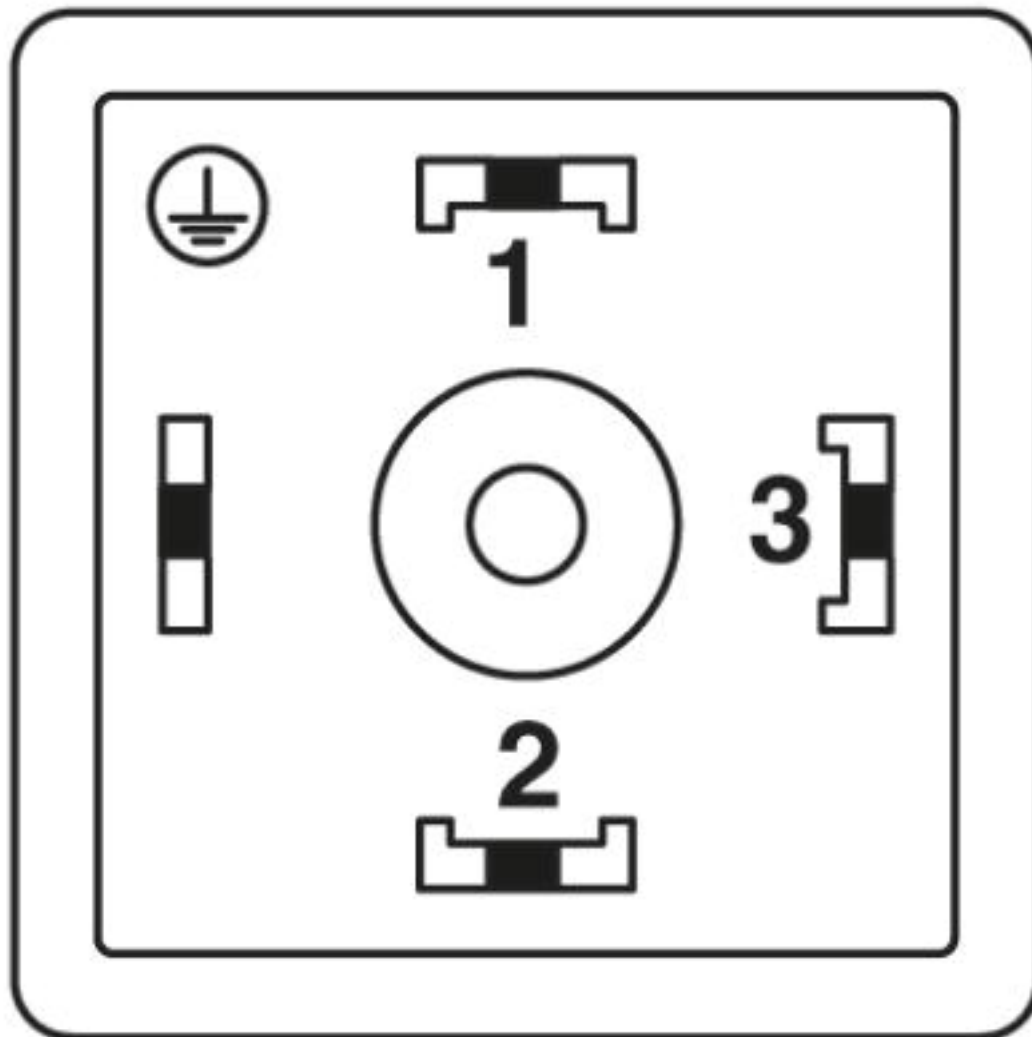

Valve plug connector pin assignment, type AD

# Sensor/actuator cable - SAC-5P- 5,0-PUO/AD-2L OD - 1407293

Dimensional drawing

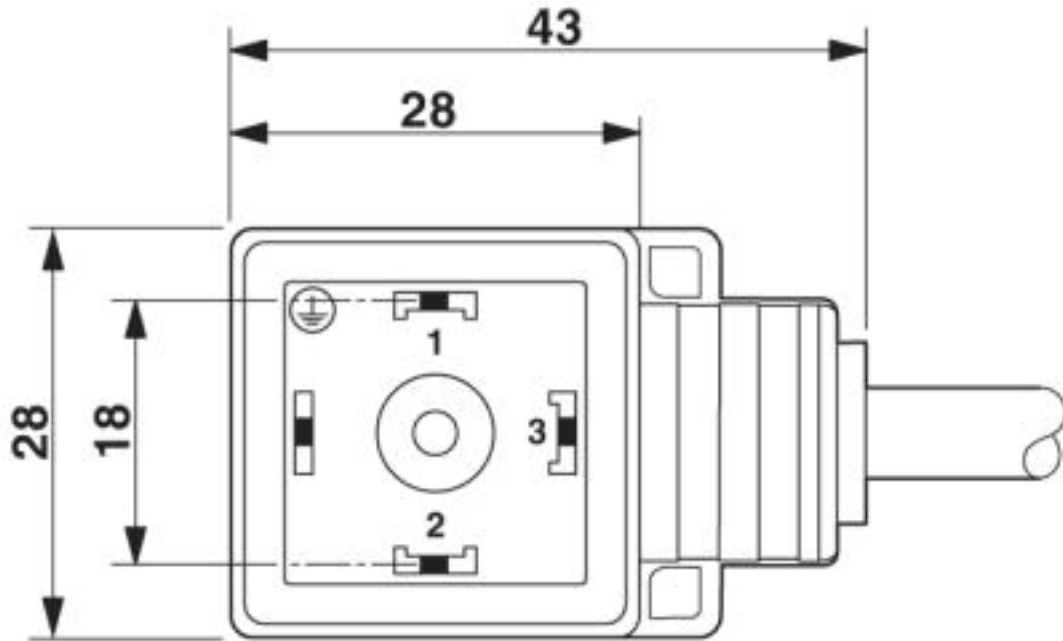

Valve connector, type AD

Dimensional drawing

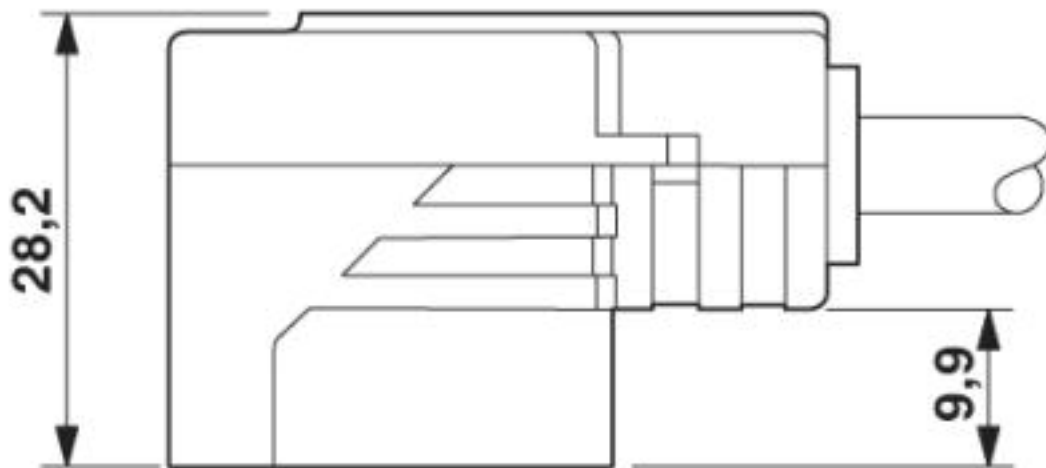

Valve connector, type AD, side view

# Sensor/actuator cable - SAC-5P- 5,0-PUO/AD-2L OD - 1407293

Circuit diagram

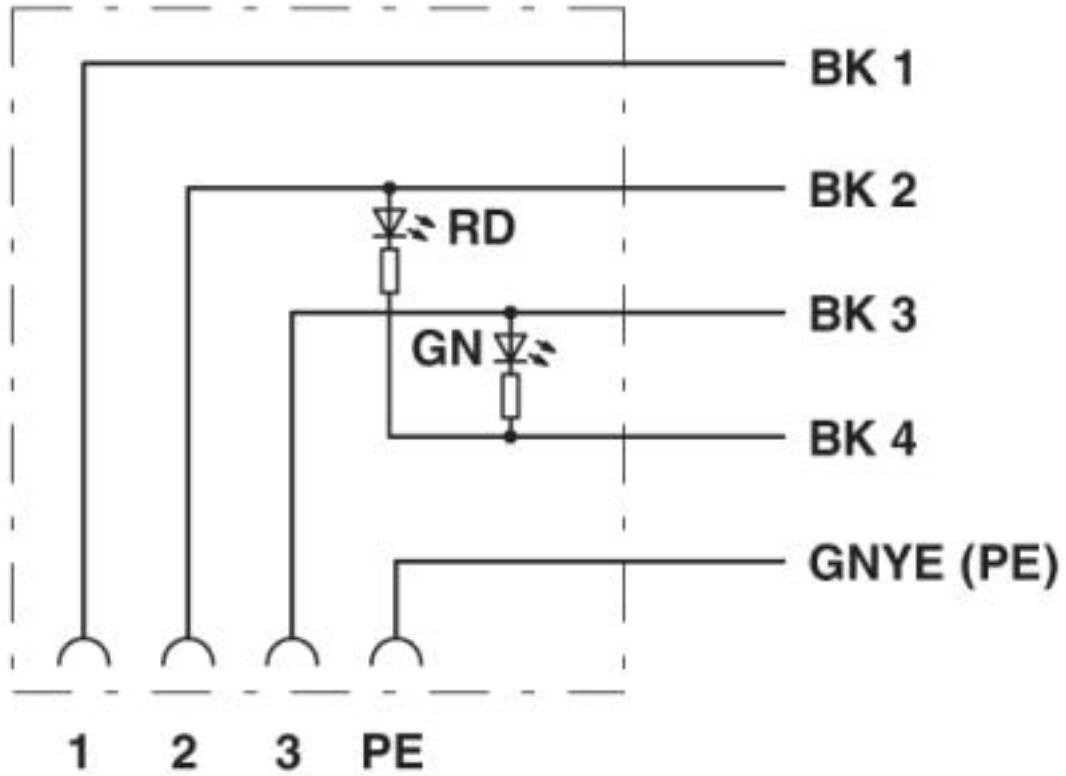

Contact assignment of the valve plug

# Sensor/actuator cable - SAC-5P- 5,0-PUO/AD-2L OD - 1407293

Cable cross section

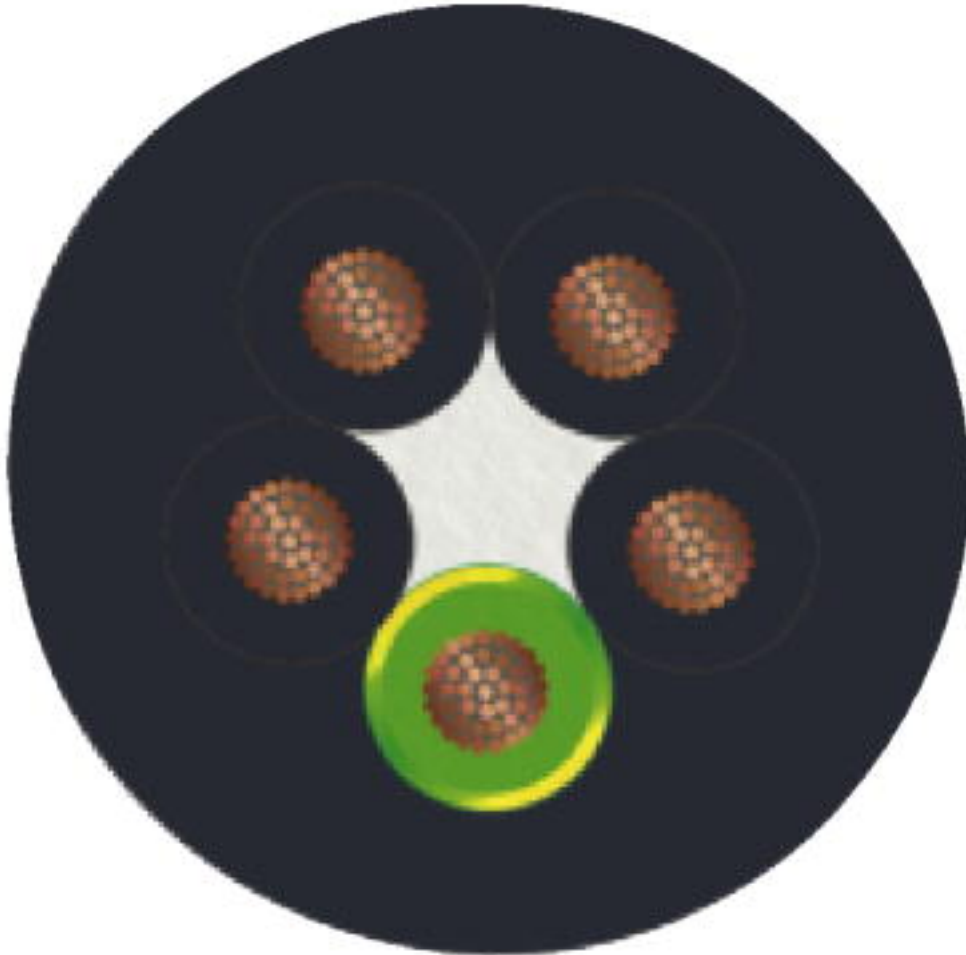

PUR halogen-free black [PUO]

## Approvals

Approvals

---

Approvals

CSAus / EAC

---

Ex Approvals

---

Approval details

## Sensor/actuator cable - SAC-5P- 5,0-PUO/AD-2L OD - 1407293

### Approvals

CSAus		<a href="http://www.csagroup.org/services-industries/product-listing/">http://www.csagroup.org/services-industries/product-listing/</a>	13631
Nominal voltage UN		24 V	
Nominal current IN		6 A	

EAC		RU C- DE.BL08.B.00286
-----	---	--------------------------

Phoenix Contact 2019 © - all rights reserved  
<http://www.phoenixcontact.com>

PHOENIX CONTACT GmbH & Co. KG  
Flachsmarktstr. 8  
32825 Blomberg  
Germany  
Tel. +49 5235 300  
Fax +49 5235 3 41200  
<http://www.phoenixcontact.com>