



# PRM<sup>®</sup> Regulator

## P048F048T12AL



### Non-isolated Regulator

#### Features

- 48 V input VI Chip<sup>®</sup> PRM<sup>®</sup>
- Vin range 36 – 75 Vdc
- High density – 407 W/in<sup>3</sup>
- Small footprint – 108 W/in<sup>2</sup>
- Low weight – 0.5 oz (15 g)
- Adaptive Loop feedback
- ZVS buck-boost regulator
- 1.45 MHz switching frequency
- 96% Efficiency
- 125 °C operation (Tj)

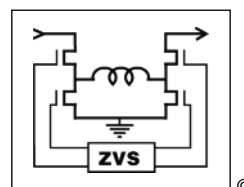

$V_{IN} = 36 - 75 \text{ V}$   
 $V_{OUT} = 26 - 55 \text{ V}$   
 $P_{OUT} = 120 \text{ W}$   
 $I_{OUT} = 2.5 \text{ A}$

#### Product Description

The VI Chip<sup>®</sup> regulator is a very efficient non-isolated regulator capable of both boosting and bucking a wide range input voltage. It is specifically designed to provide a controlled Factorized Bus distribution voltage for powering downstream VTM<sup>®</sup> Transformer — fast, efficient, isolated, low noise Point-of-Load (POL) converters. In combination, PRMs and VTMs form a complete DC-DC converter subsystem offering all of the unique benefits of Vicor's Factorized Power Architecture<sup>™</sup> (FPA)<sup>™</sup>: high density and efficiency; low noise operation; architectural flexibility; extremely fast transient response; and elimination of bulk capacitance at the Point-of-Load (POL).

In FPA systems, the POL voltage is the product of the Factorized Bus voltage delivered by the PRM and the "K-factor" (the fixed voltage transformation ratio) of a downstream VTM. The PRM controls the Factorized Bus voltage to provide regulation at the POL. Because VTMs perform true voltage division and current multiplication, the Factorized Bus voltage may be set to a value that is substantially higher than the bus voltages typically found in "intermediate bus" systems, reducing distribution losses and enabling use of narrower distribution bus traces. A PRM-VTM chip set can provide up to 100 A, or 115 W at a FPA system density of 169 A/in<sup>3</sup>, or 195 W/in<sup>3</sup> — and because the PRM can be located, or "factorized," remotely from the POL, these power densities can be effectively doubled.

The PRM described in this data sheet features a unique "Adaptive Loop" compensation feedback: a single wire alternative to traditional remote sensing and feedback loops that enables precise control of an isolated POL voltage without the need for either a direct connection to the load or for noise sensitive, bandwidth limiting, isolation devices in the feedback path.

#### Absolute Maximum Ratings

Parameter	Values	Unit	Notes
+In to -In	-1.0 to 85.0	Vdc	
PC to -In	-0.3 to 6.0	Vdc	
PR to -In	-0.3 to 9.0	Vdc	
IL to -In	-0.3 to 6.0	Vdc	
VC to -In	-0.3 to 18.0	Vdc	
+Out to -Out	-0.3 to 59	Vdc	
SC to -Out	-0.3 to 3.0	Vdc	
VH to -Out	-0.3 to 9.5	Vdc	
OS to -Out	-0.3 to 9.0	Vdc	
CD to -Out	-0.3 to 9.0	Vdc	
SG to -Out	100	mA	
Continuous output current	2.5	Adc	
Continuous output power	120	W	
Case temperature during reflow	225	°C	MSL 5
	245	°C	MSL 6
Operating junction temperature	-40 to 125	°C	T-Grade
Storage temperature	-40 to 125	°C	T-Grade

#### DC-DC Converter

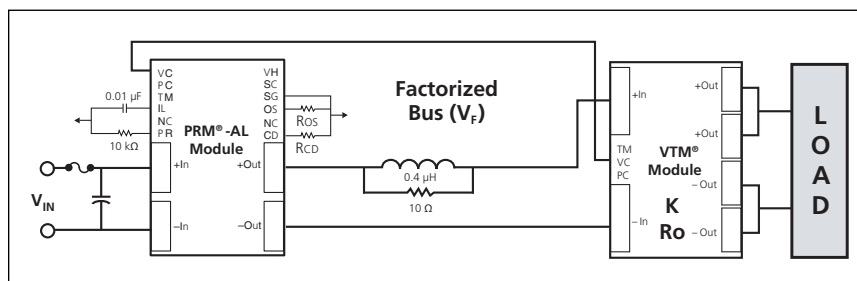

The P048F048T12AL is used with any 048 input series VTM to provide a regulated and isolated output.

## General Specifications

### Overview of Adaptive Loop Compensation

Adaptive Loop compensation, illustrated in Figure 1, contributes to the bandwidth and speed advantage of Factorized Power. The PRM<sup>®</sup> monitors its output current and automatically adjusts its output voltage to compensate for the voltage drop in the output resistance of the VTM<sup>®</sup>.  $R_{OS}$  sets the desired value of the VTM output voltage,  $V_{out}$ ;  $R_{CD}$  is set to a value that compensates for the output resistance of the VTM (which, ideally, is located at the point of load). For more information on configuring a PRM & VTM pair for adaptive loop, please see [AN:024](#) "Accurate Point of Load Voltage Regulation Using Simple Adaptive Loop Feedback."

The VI Chip's bi-directional VC port :

1. Provides a wake up signal from the PRM to the VTM that synchronizes the rise of the VTM output voltage to that of the PRM.
2. Provides feedback from the VTM to the PRM to enable the PRM to compensate for the voltage drop in VTM output resistance,  $R_o$ .

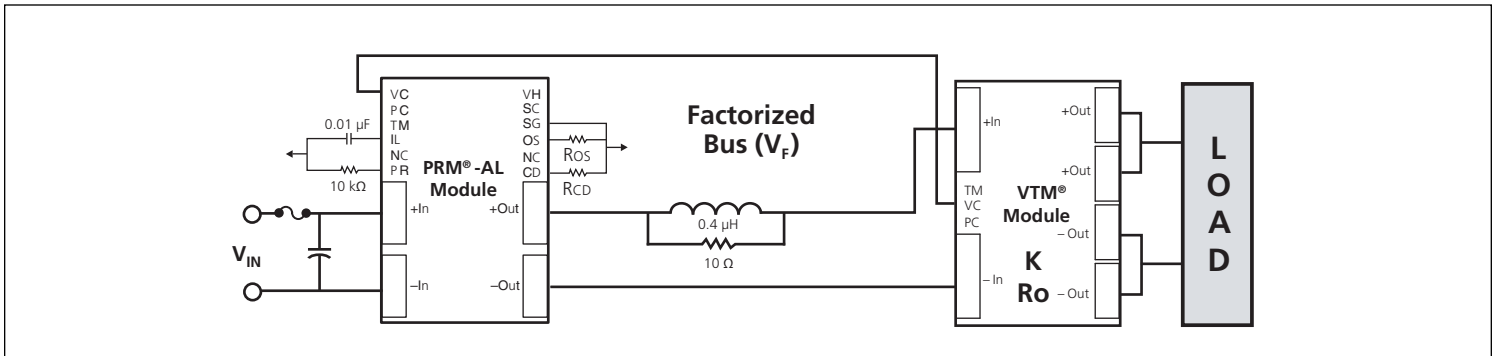

**Figure 1** — With Adaptive Loop control, the output of the VTM is regulated over the load current range with only a single interconnect between the PRM and VTM and without the need for isolation in the feedback path.

## Electrical Specifications

**Input Specs** (Conditions are at 48 V<sub>IN</sub>, 48 V<sub>OUT</sub>, full load, and 25 °C ambient unless otherwise specified)

Parameter	Min	Typ	Max	Unit	Note
Input voltage range	36	48	75	Vdc	
Input dV/dt			1	V/μs	
Input undervoltage turn-on		33.8	35.3	Vdc	
Input undervoltage turn-off	30.4	31.8		Vdc	
Input overvoltage turn-on	75.7	77.3		Vdc	
Input overvoltage turn-off		78.8	81.0	Vdc	
Input quiescent current		0.5	1	mA	PC low
Input current		2.6		Adc	
Input reflected ripple current		280		mA p-p	See Figures 4 & 5
No load power dissipation		2.4	4	W	
Internal input capacitance		5		μF	Ceramic
Recommended external input capacitance		100		μF	See Figure 5 for input filter circuit. Source impedance dependent

[a] Will operate down to 13.5 V after start up ≥ 16 V

## Input Waveforms

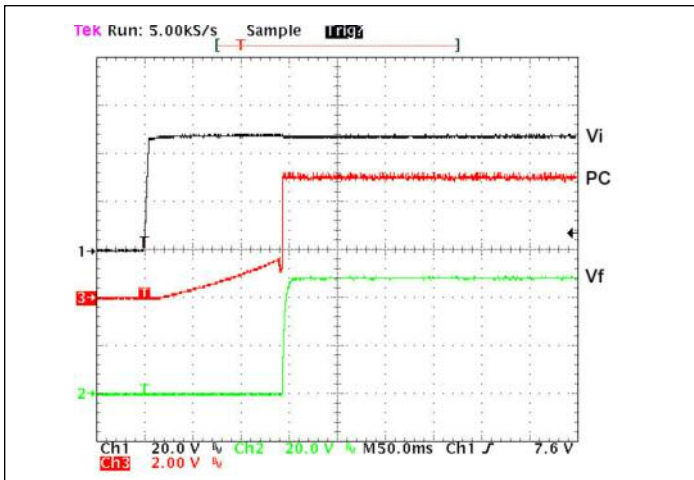

Figure 2 — V<sub>OUT</sub> and PC response from power up

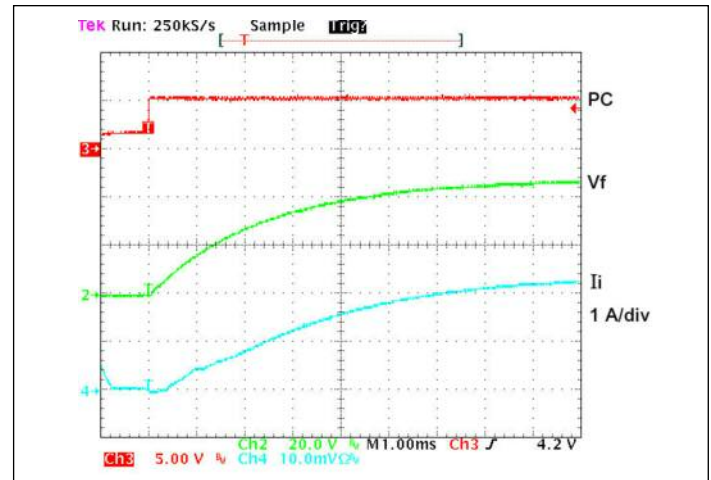

Figure 3 — V<sub>OUT</sub> turn on waveform with inrush current – PC enabled

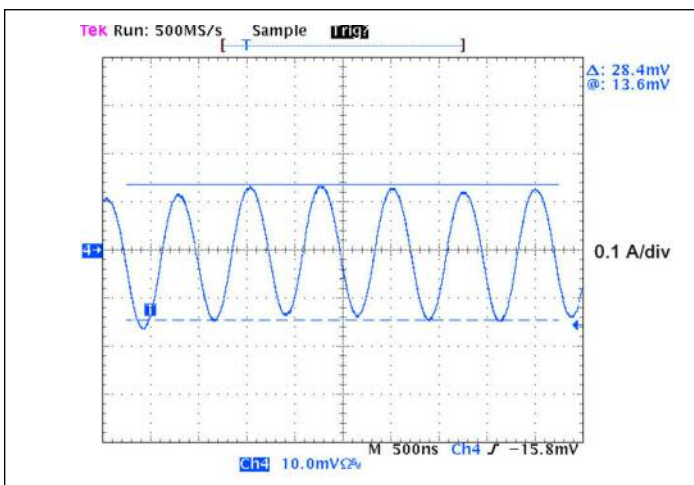

Figure 4 — Input reflected ripple current at full load and 28 V<sub>IN</sub>

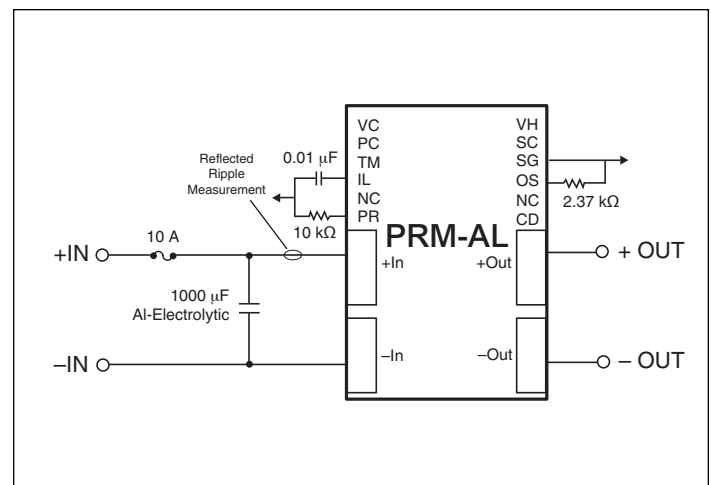

Figure 5 — Input filter capacitor recommendation

**Electrical Specifications** (continued)**Output Specs** (Conditions are at 48 V<sub>IN</sub>, 48 V<sub>OUT</sub>, full load, and 25 °C ambient unless otherwise specified)

Parameter	Min	Typ	Max	Unit	Note
Output voltage range	26	48	55	Vdc	Factorized Bus voltage (Vf) set by R <sub>OS</sub>
Output power	0		120	W	
Output current	0		2.5	A <sub>dc</sub>	
DC current limit	2.6	3.0	3.3	A <sub>dc</sub>	I <sub>L</sub> pin floating
Average short circuit current			0.5	A	Auto recovery
Set point accuracy		1.0	1.5	%	R <sub>OS</sub> = 2.37 K, no CD resistor
Line regulation		0.1	0.2	%	Low line to high line
Load regulation		0.1	0.2	%	No CD resistor
Load regulation (at VTM output)		1.0	2.0	%	Adaptive Loop
Current share accuracy		5.5	15	%	
Efficiency					
Full load	94.5	95.5		%	See Figure 6,7 & 8
Output overvoltage set point	56		59.4	Vdc	
Output ripple voltage					
No external bypass		1.0	2.0	%	Factorized Bus, see Figure 13
With 10 μF capacitor		0.5	1.0	%	Factorized Bus, see Figure 14
Switching frequency	1.35	1.45	1.55	MHz	Fixed frequency
Output turn-on delay					
From application of power		200	300	ms	See Figure 2
From PC pin enable	800	1200	1600	μs	See Figure 3
Internal output capacitance		5		μF	Ceramic
Factorized Bus capacitance			47	μF	

Electrical Specifications (continued)

Efficiency Charts

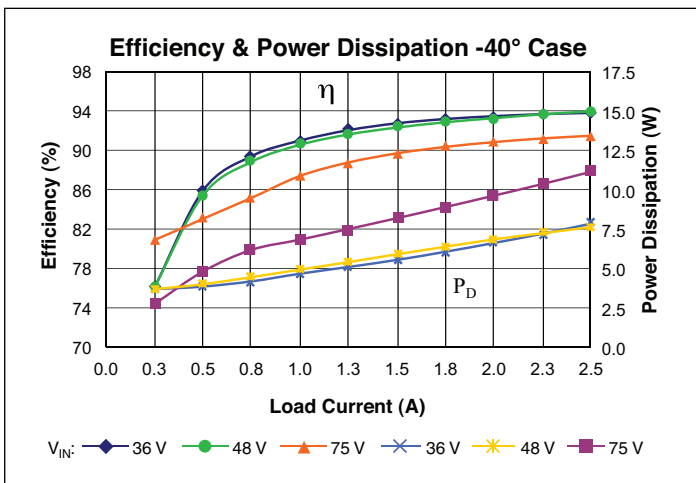

Figure 6 — Efficiency and power dissipation vs. output current at 36 V<sub>OUT</sub>, -40 °C T<sub>CASE</sub>

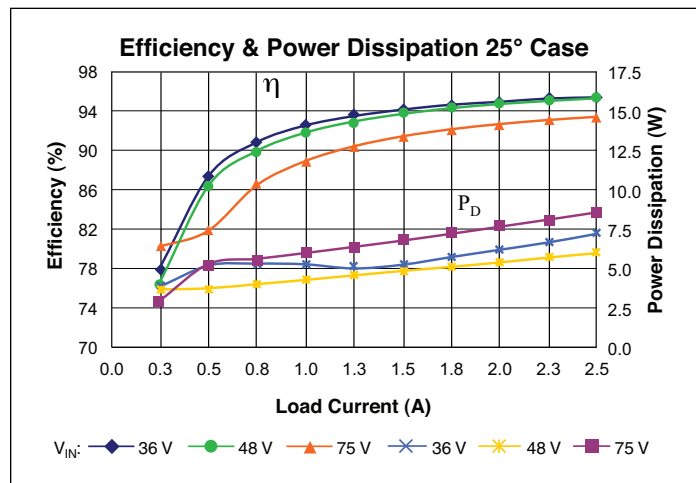

Figure 7 — Efficiency and power dissipation vs. output current at 36 V<sub>OUT</sub>, 25 °C T<sub>CASE</sub>

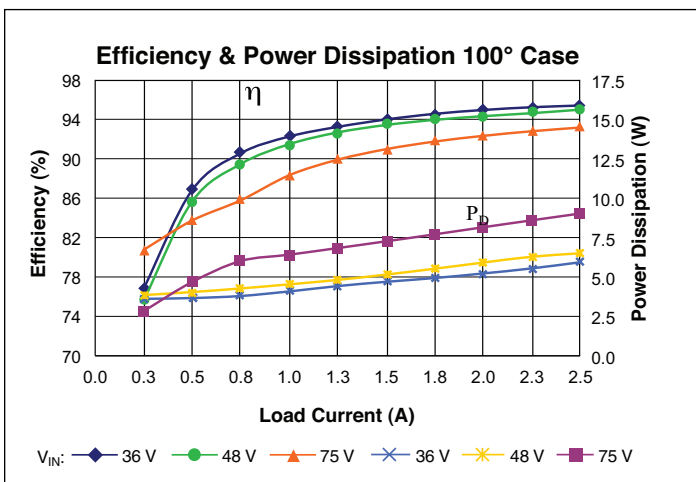

Figure 8 — Efficiency and power dissipation vs. output current at 36 V<sub>OUT</sub>, 100 °C T<sub>CASE</sub>

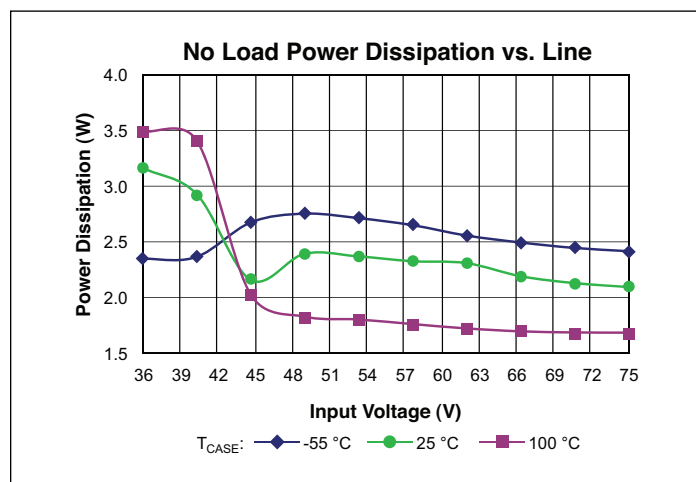

Figure 9 — No load power, unit enabled vs. line

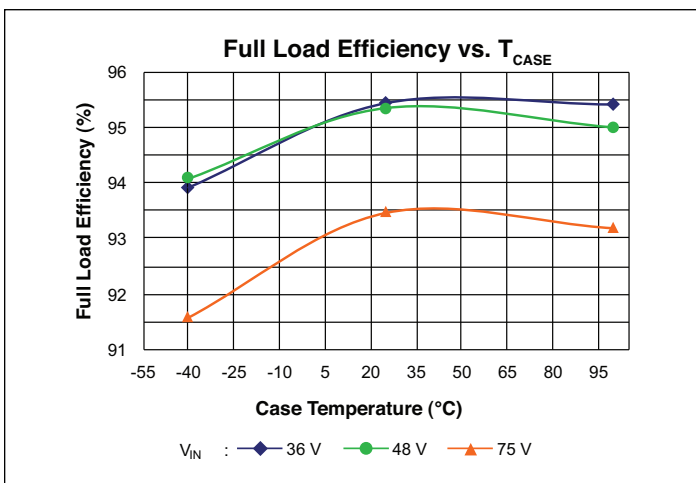

Figure 10 — Full load efficiency vs T<sub>CASE</sub>

Electrical Specifications (continued)

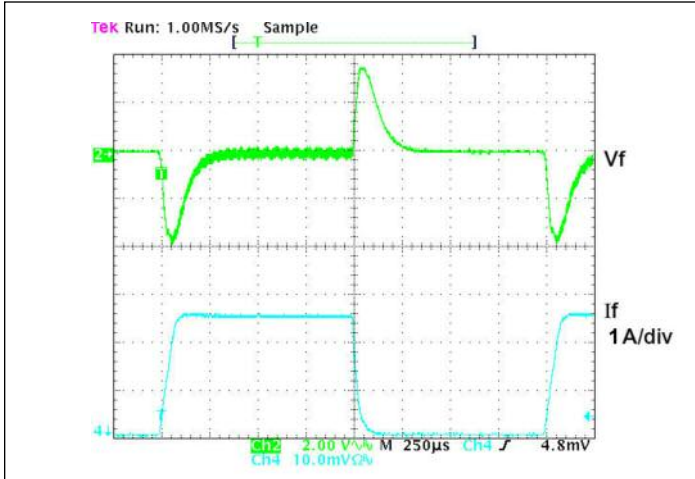

Figure 11 — Transient response; PRM<sup>®</sup> alone 48 Vin, 0–2.5–0 A, no load capacitance, local loop

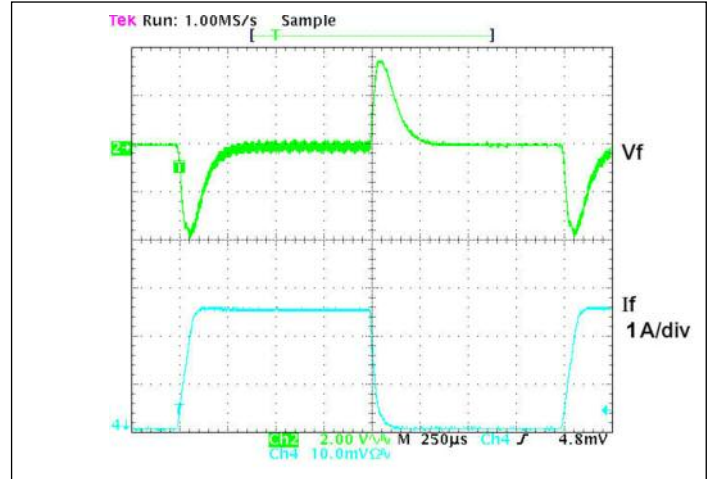

Figure 12 — Transient response; PRM<sup>®</sup> alone 36 Vin, 0–2.5–0 A, no load capacitance, local loop

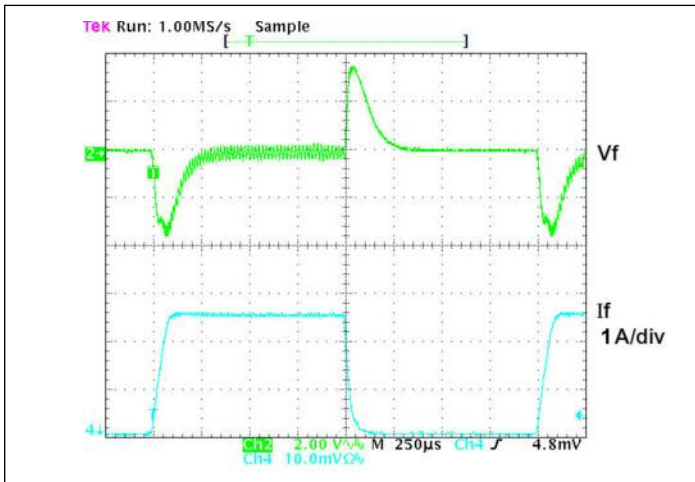

Figure 13 — Transient response; PRM<sup>®</sup> alone, 26 Vin, 0–2.5–0 A no load capacitance. Local Loop

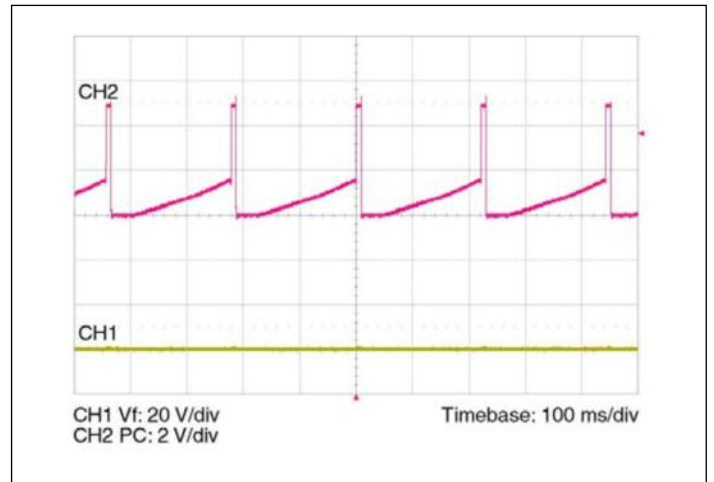

Figure 14 — PC during fault – frequency will vary as a function of line voltage.

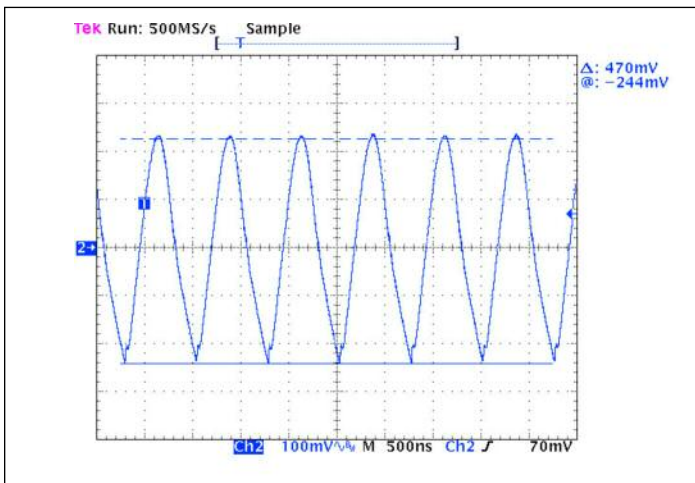

Figure 15 — Output ripple full load no bypass capacitance. Vf = 48 Vdc

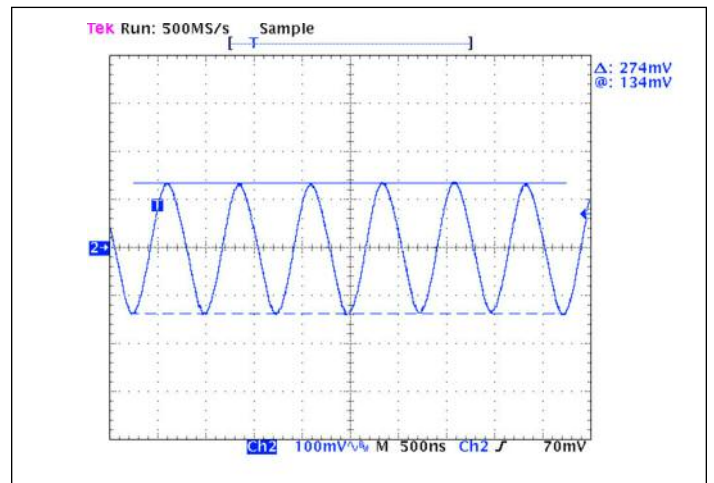

Figure 16 — Output ripple full load 10µF bypass capacitance. Vf = 48 Vdc

**Electrical Specifications** (continued)

**Auxiliary Pins** (Conditions are at 48 V<sub>IN</sub>, 48 V<sub>OUT</sub>, full load, and 25 °C ambient unless otherwise specified)

Parameter	Min	Typ	Max	Unit	Note
VC (VTM Control)					
Pulse width	8	12	18	ms	
Peak voltage	12	14	18	V	Referenced to –Out
PC (Primary Control)					
DC voltage	4.8	5.0	5.2	Vdc	Referenced to –In
Module disable voltage	2.3	2.4		Vdc	Referenced to –In
Module enable voltage		2.5	2.6	Vdc	
Disable hysteresis		100		mV	
Current limit		1.75	1.90	mA	Source only after start up; not to be used for aux. supply; 100 kΩ minimum load impedance to assure start up.
Enable delay time	800	1200	1600	μs	
Disable delay time		1		μs	
IL (Current Limit Adjust)					
Voltage		1		V	
Accuracy		± 15		%	Based on DC current limit set point
PR (Parallel Port)					
Voltage	5.15		6.35	V	Referenced to SG; See description Page 8
Source current	1			mA	
External capacitance			100	pF	
VH (Auxiliary Voltage)					
Range	8.7	9.0	9.3	Vdc	Typical internal bypass C=0.1 μF Maximum external C=0.1 μF, referenced to SG
Regulation		0.04		%/mA	
Current			5	mA p	
SC (Secondary Control)					
Voltage	1.23	1.24	1.25	Vdc	Referenced to SG
Internal capacitance		0.22		μF	
External capacitance			0.7	μF	
OS (Output Set)					
Set point accuracy		± 1.5		%	Includes 1% external resistor
Reference offset		± 4		mV	
CD (Compensation Device)					
External resistance	20			Ω	Omit resistor for regulation at output of PRM

**General Specs**

Parameter	Min	Typ	Max	Unit	Note
MTBF					
MIL-HDBK-217F		3.505		Mhrs	25°C, GB
Agency approvals		cTUVus			UL/CSA 60950-1, EN60950-1
		CE Marked for Low Voltage Directive and RoHS			Recast Directive, as applicable
Mechanical parameters					
Weight		0.53/15		oz/g	See Mechanical Drawings, Figures 19 – 22
Dimensions					
Length		1.28/32,5		in/mm	
Width		0.87/22		in/mm	
Height		0.265/6,73		in/mm	
Thermal					
Over temperature shutdown	130	135	140	°C	Junction temperature
Thermal capacity		9.3		Ws/°C	
Junction-to-case thermal impedance (R <sub>θJC</sub> )		1.1		°C/W	
Junction-to-board thermal impedance (R <sub>θJB</sub> )		2.1		°C/W	
Case-to-ambient		3.7		°C/W	With 0.25" heat sink @ 300 LFM

Pin / Control Functions

**+In / -In DC Voltage Ports**

The VI Chip® maximum input voltage should not be exceeded. PRMs have internal over / undervoltage lockout functions that prevent operation outside of the specified input range. PRMs will turn on when the input voltage rises above its undervoltage lockout. If the input voltage exceeds the overvoltage lockout, PRMs will shut down until the overvoltage fault clears. PC will toggle indicating an out of bounds condition.

**+Out / -Out Factorized Voltage Output Ports**

These ports provide the Factorized Bus voltage output. The –Out port is connected internally to the –In port through a current sense resistor. The PRM® has a maximum power and a maximum current rating and is protected if either rating is exceeded. Do not short –Out to –In.

**VC – VTM Control**

The VTM® Control (VC) port supplies an initial V<sub>CC</sub> voltage to downstream VTMs, enabling the VTMs and synchronizing the rise of the VTM output voltage to that of the PRM. The VC port also provides feedback to the PRM to compensate for voltage drop due to the VTM output resistance. The PRM’s VC port should be connected to the VTM VC port. A PRM VC port can drive a maximum of two (2) VTM VC ports.

**PC – Primary Control**

The PRM voltage output is enabled when the PC pin is open circuit (floating). To disable the PRM output voltage, the PC pin is pulled low. Open collector optocouplers, transistors, or relays can be used to control the PC pin. When using multiple PRMs in a high power array, the PC ports must be tied together to synchronize their turn on. During an abnormal condition the PC pin will pulse (Fig.14) as the PRM initiates a restart cycle. This will continue until the abnormal condition is rectified. The PC should not be used as an auxiliary voltage supply, nor should it be switched at a rate greater than 1 Hz.

**TM – Factory Use Only**

**IL – Current Limit Adjust**

The PRM has a preset, maximum, current limit set point. The IL port may be used to reduce the current limit set point to a lower value. See “adjusting current limits” on page 10.

**PR – Parallel Port**

The PR port signal, which is proportional to the PRM output power, supports current sharing of two PRMs. To enable current sharing, PR ports should be interconnected. Steps should be taken to minimize coupling noise into the interconnecting bus. Terminate this port with a 10 k equivalent resistance to SG, e.g. 10 k for a single PRM, 20 k each for 2 PRMs in parallel, 30 k each for 3 PRMs in parallel etc.. Please consult Vicor Applications Engineering regarding additional considerations when paralleling more than two PRMs.

**VH – Auxiliary Voltage**

VH is a gated (e.g. mirrors PC), non-isolated, nominally 9 Volt, regulated DC voltage (see “Auxiliary Pins” specifications, on Page 7) that is referenced to SG. VH may be used to power external circuitry having a total current consumption of no more than 5 mA under either transient or steady state conditons including turn-on.

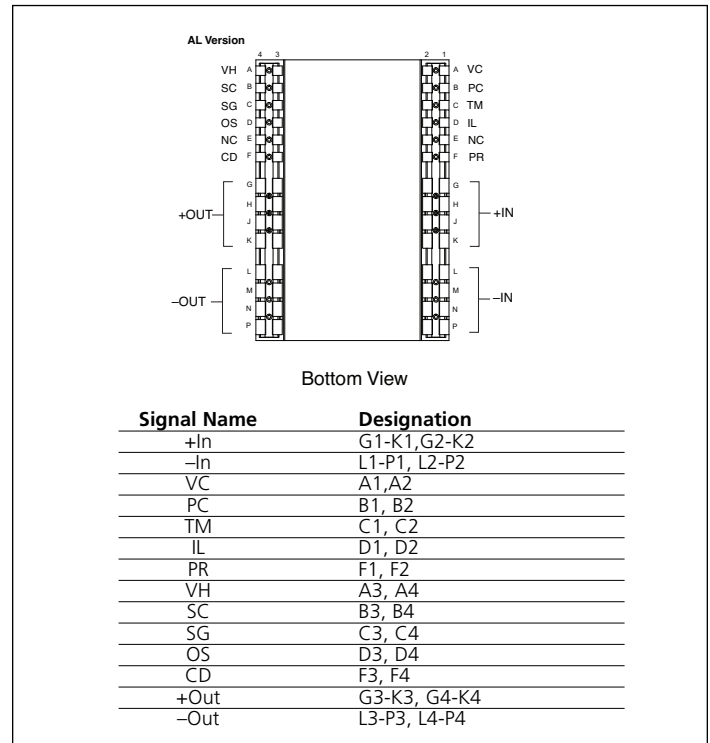

Figure 17 — PRM pin configuration

**SC – Secondary Control**

The load voltage may be controlled by connecting a resistor or voltage source to the SC port referenced to SG. The slew rate of the output voltage may be controlled by controlling the rate-of-rise of the voltage at the SC port (e.g., to limit inrush current into a capacitive load).

**SG – Signal Ground**

This port provides a low inductance Kelvin connection to –In and should be used as reference for the OS, CD, SC, VH and IL ports.

**OS – Output Set**

The application-specific value of the Factorized Bus voltage (V<sub>f</sub>) is set by connecting a resistor between OS and SG. Resistor value selection is shown in Table 1 on Page 2, and described on Page 9. If no resistor is connected, the PRM output will be approximately one volt. If set resistor is not collocated with the PRM, a local bypass capacitor of ~200 pF may be required.

**CD – Compensation Device**

Adaptive Loop control is configured by connecting an external resistor between the CD port and SG. Selection of an appropriate resistor value (see Equation 2 on Page 9) configures the PRM to compensate for voltage drops in the equivalent output resistance of the VTM and the PRM-VTM distribution bus. If no resistor is connected to CD, the PRM will be in Local Loop mode and will regulate the +Out / –Out voltage to a fixed value.



Application Information

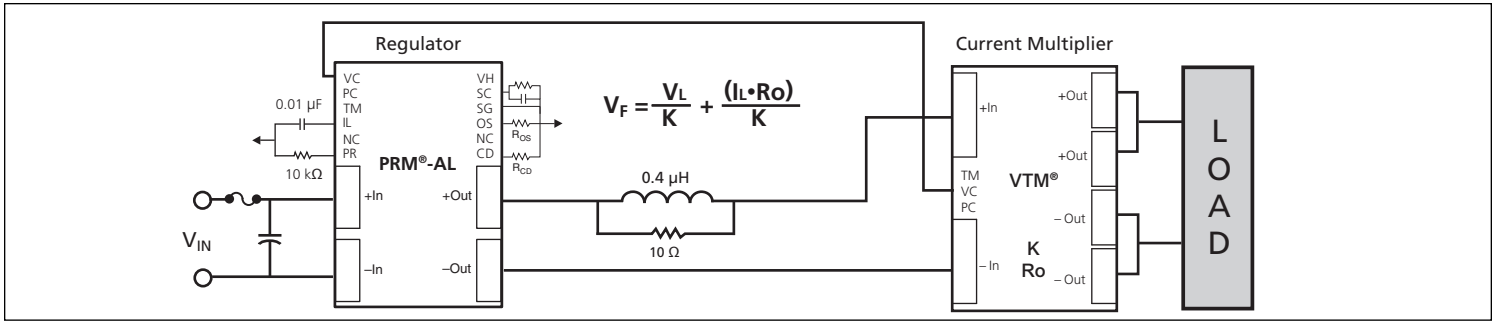

Figure 18 — Adaptive Loop compensation with output voltage trimming and soft start using the SC port.

Output Voltage Setting with Adaptive Loop

The equations for calculating  $R_{OS}$  and  $R_{CD}$  to set a VTM<sup>®</sup> output voltage are:

$$R_{OS} = \frac{93100}{\left( \frac{V_L \cdot 0.8395}{K} \right) - 1} \quad (1)$$

$$R_{CD} = \frac{91238}{R_{OS}} + 1 \quad (2)$$

- $V_L$  = Desired load voltage
- $V_{OUT}$  = VTM output voltage
- $K$  = VTM transformation ratio  
(available from appropriate VTM data sheet)
- $V_f$  = PRM output voltage, the Factorized Bus (see Figure 16)
- $R_O$  = VTM output resistance  
(available from appropriate VTM data sheet)
- $I_L$  = Load Current  
(actual current delivered to the load)

Output Voltage Trimming (optional)

After setting the output voltage from the procedure above the output may be margined down ( $26 V_f \text{ min}$ ) by a resistor from SC-SG using this formula:

$$R_d \Omega = \frac{10000 V_{fd}}{V_{fs} - V_{fd}}$$

Where  $V_{fd}$  is the desired factorized bus and  $V_{fs}$  is the set factorized bus. A low voltage source can be applied to the SC port to margin the load voltage in proportion to the SC reference voltage. An external capacitor can be added to the SC port as shown in Figure 16 to control the output voltage slew rate for soft start.

Nominal Vout Range (Vdc)	VTM K Factor
0.8 ↔ 1.6	1/32
1.1 ↔ 2.2	1/24
1.6 ↔ 3.3	1/16
2.2 ↔ 4.4	1/12
3.3 ↔ 6.6	1/8
4.3 ↔ 8.8	1/6
6.5 ↔ 13.4	1/4
8.7 ↔ 17.9	1/3
13.0 ↔ 26.9	1/2
17.4 ↔ 36.0	2/3
26.0 ↔ 54.0	1

Table 1 — 048 input series VTM K factor selection guide

Application Information (continued)

OVP – Overvoltage Protection

The output Overvoltage Protection set point of the P048F048T12AL is factory preset for 56 V. If this threshold is exceeded the output shuts down and a restart sequence is initiated, also indicated by PC pulsing. If the condition that causes OVP is still present, the unit will again shut down. This cycle will be repeated until the fault condition is removed. The OVP set point may be set at the factory to meet unique high voltage requirements.

PRM® Output Power Versus VTM® Output Power

As shown in Figure 19, the P048F048T12AL is rated to deliver 2.5 A maximum, when it is delivering an output voltage in the range from 26 V to 48 V, and 120 W, maximum, when delivering an output voltage in the range from 48 V to 55 V. When configuring a PRM for use with a specific VTM, refer to the appropriate VTM data sheet. The VTM input power can be calculated by dividing the VTM output power by the VTM efficiency (available from the VTM data sheet). The input power required by the VTM should not exceed the output power rating of the PRM.

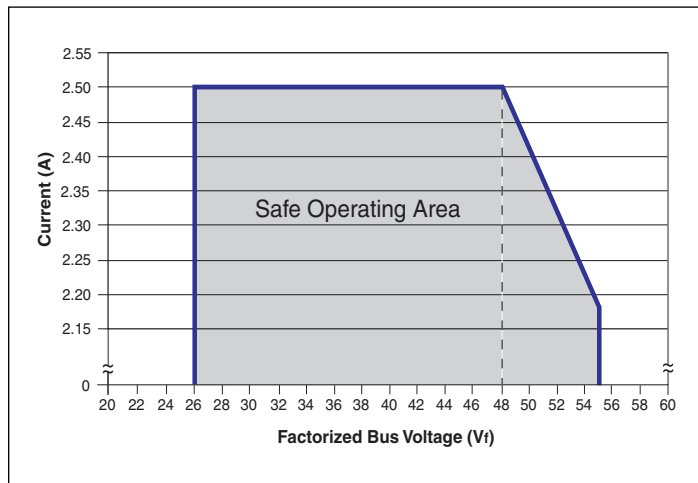

Figure 19 — P048F048T12AL rating based on Factorized Bus voltage

The Factorized Bus voltage should not exceed an absolute limit of 55 V, including steady state, ripple and transient conditions. Exceeding this limit may cause the internal OVP set point to be exceeded.

Parallel Considerations

The PR port is used to connect two PRMs in parallel to form a higher power array. When configuring arrays, PR port interconnection terminating impedance is 10 k to SG. See note Page 8 and refer to Application Note AN002. Additionally one PRM should be designated as the master while all other PRMs are set as slaves by shorting their SC pin to SG. The PC pins must be directly connected (no diodes) to assure a uniform start up sequence. Consult Vicor applications engineering for applications requiring more than two PRMs.

Adjusting Current Limit

The current limit can be lowered by placing an external resistor between the IL and SG ports (see Figure 20 for resistor values). With the IL port open-circuit, the current limit is preset to be within the range specified in the output specifications table on Page 4.

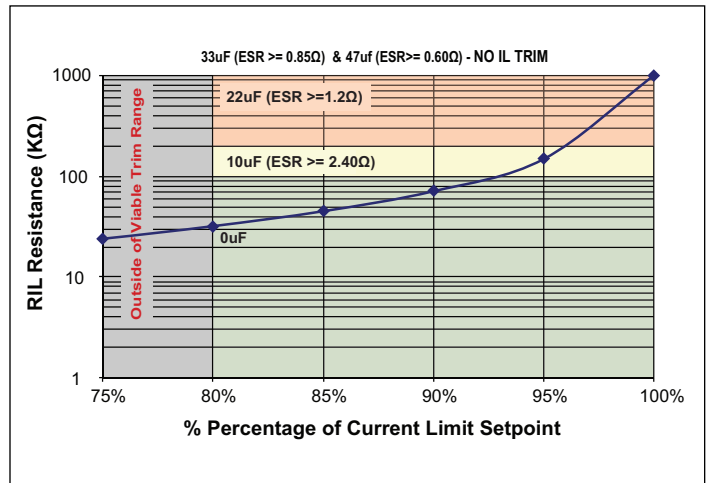

Figure 20 —  $R_{IL}$  vs percentage of current limit. Shaded areas shown minimum valid  $R_{IL}$  as a function of load capacitance and ESR.

Input Fuse Recommendations

A fuse should be incorporated at the input to the PRM, in series with the +In port. A fast acting fuse, NANO2 FUSE 451/453 Series 10 A 125 V, or equivalent, may be required to meet certain safety agency Conditions of Acceptability. Always ascertain and observe the safety, regulatory, or other agency specifications that apply to your specific application.

Product Safety Considerations

If the input of the PRM is connected to SELV or ELV circuits, the output of the PRM can be considered SELV or ELV respectively.

If the input of the PRM is connected to a centralized DC power system where the working or float voltage is above SELV, but less than or equal to 75 V, the input and output voltage of the PRM should be classified as a TNV-2 circuit and spaced 1.3 mm from SELV circuitry or accessible conductive parts according to the requirements of UL60950-1, CSA 22.2 60950-1, EN60950-1, and IEC60950-1.

Applications Assistance

Please contact Vicor Applications Engineering for assistance, 1-800-927-9474, or email at apps@vicorpower.com.

Mechanical Drawings

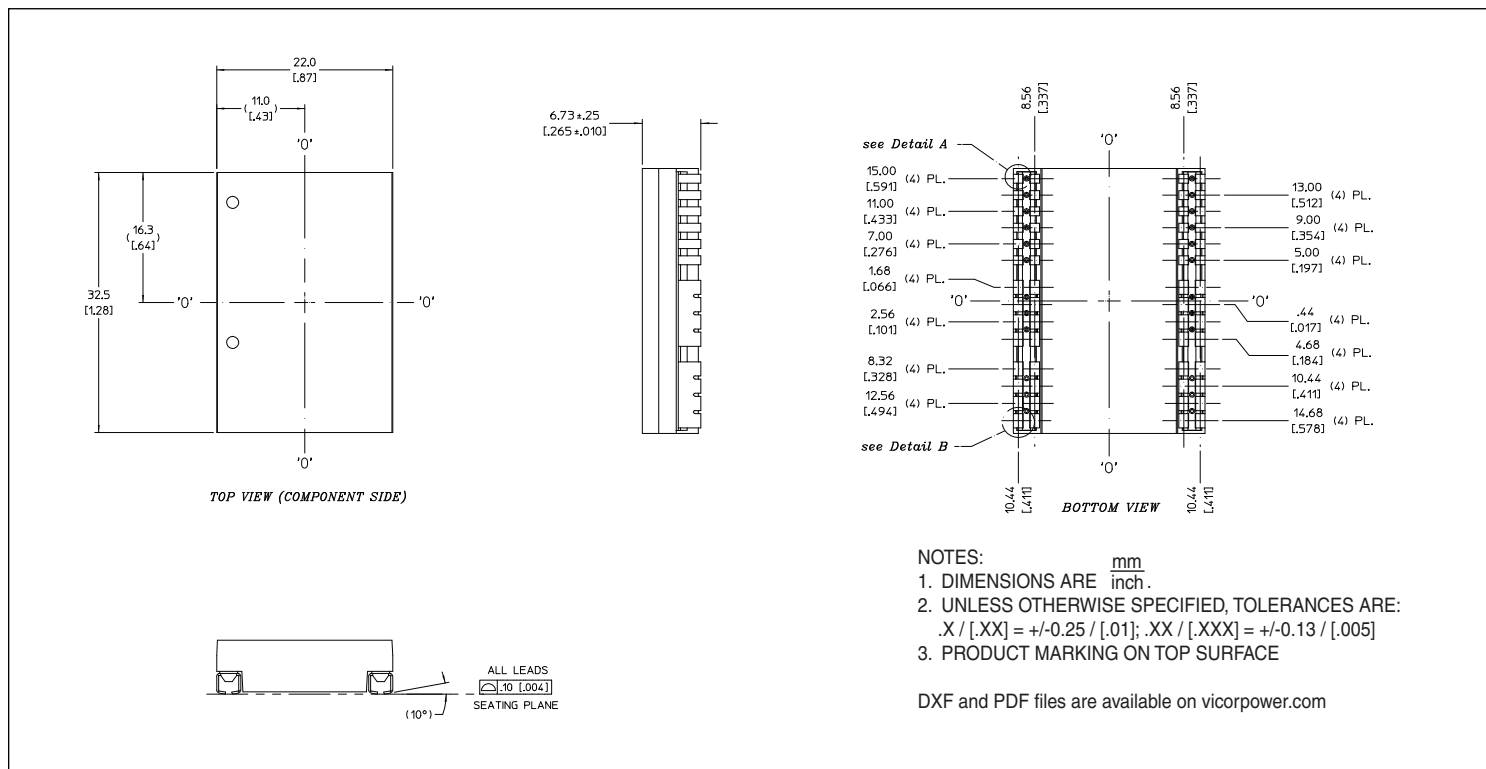

Figure 21 — PRM® module J-Lead mechanical outline

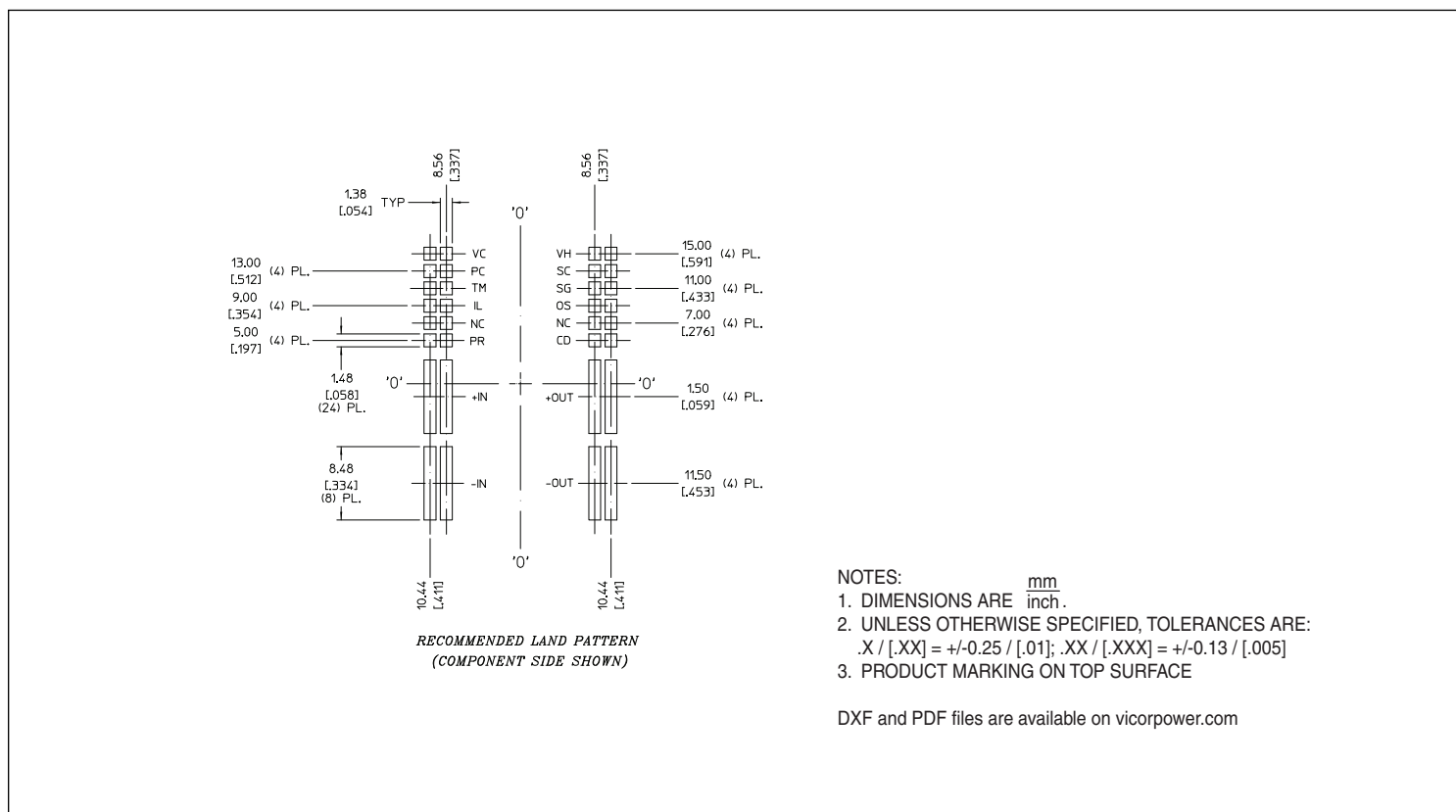

Figure 22 — PRM® module J-Lead PCB land layout information

Mechanical Drawings (continued)

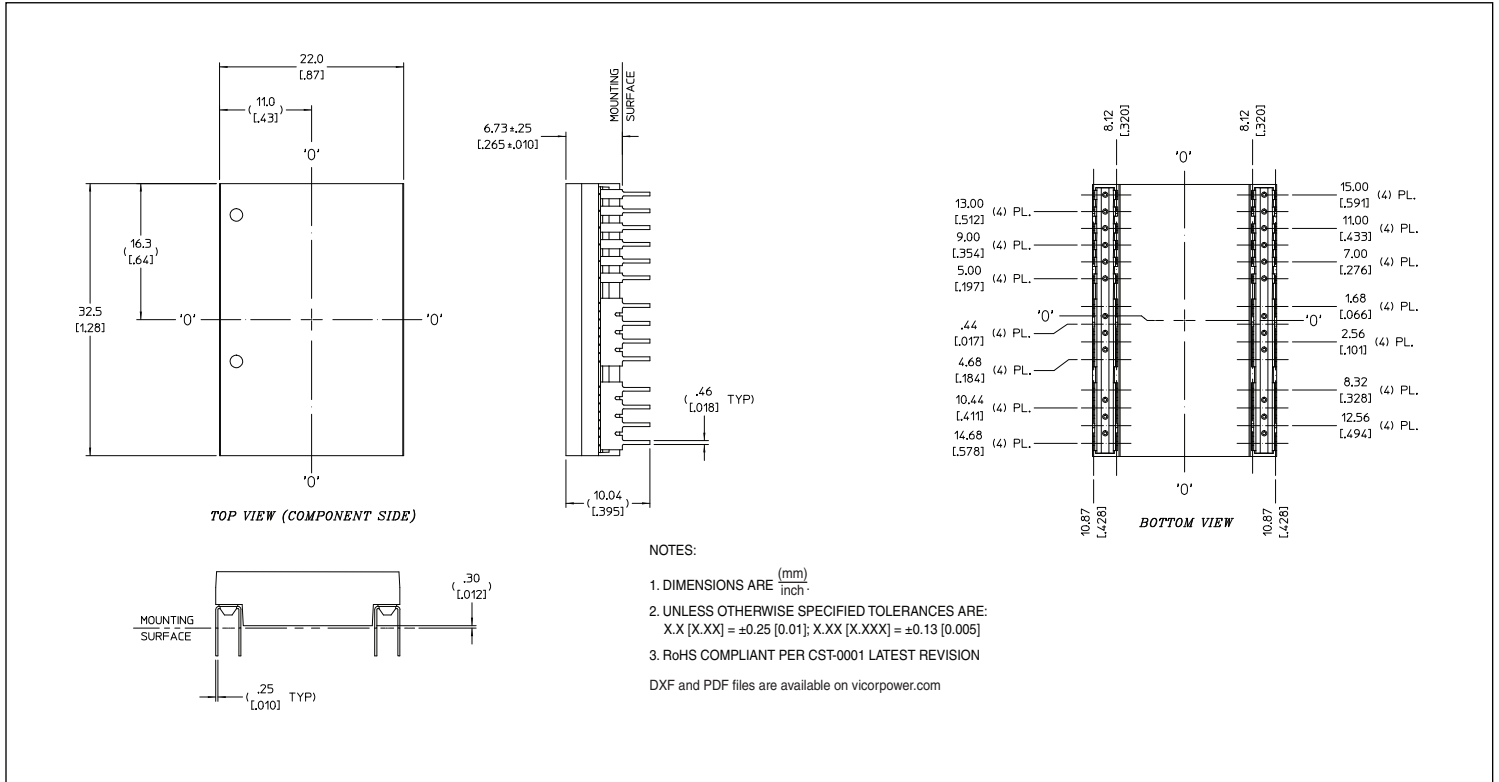

Figure 23 — PRM® module through-hole mechanical outline

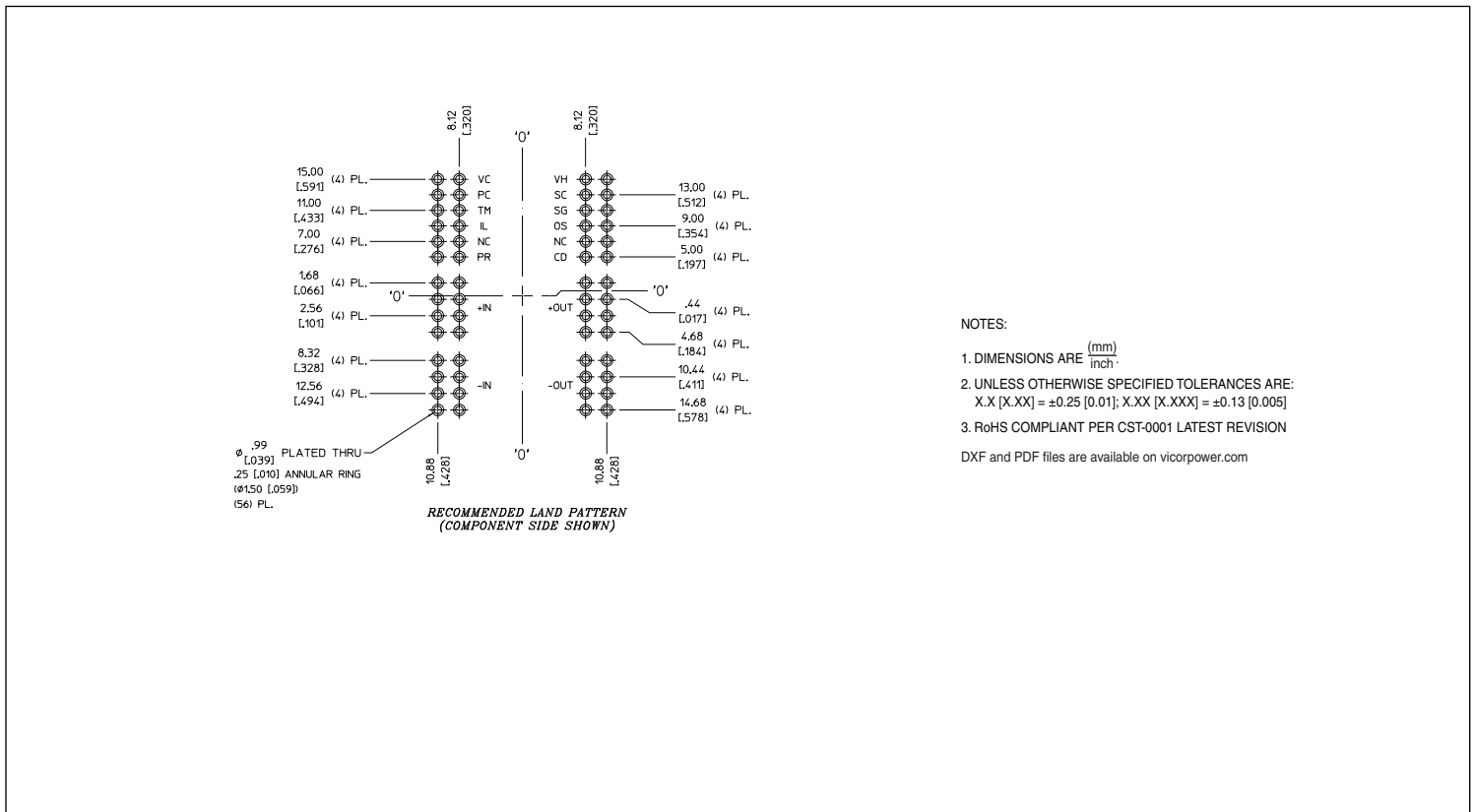

Figure 24 — PRM® module through-hole PCB layout information

Configuration Options

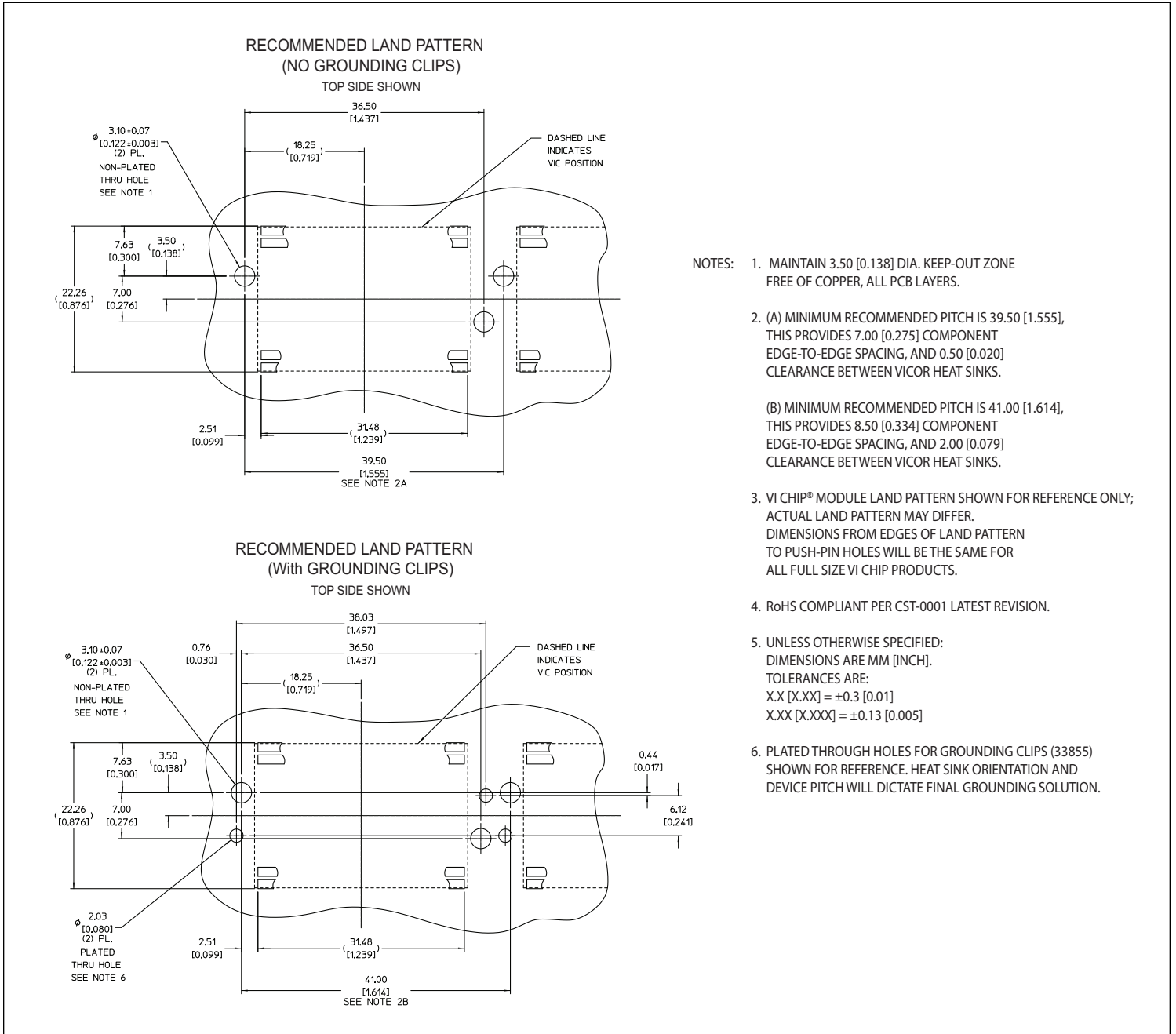

Figure 25 — Recommended heat sink push pin location

**Vicor's comprehensive line of power solutions includes high density AC-DC and DC-DC modules and accessory components, fully configurable AC-DC and DC-DC power supplies, and complete custom power systems.**

Information furnished by Vicor is believed to be accurate and reliable. However, no responsibility is assumed by Vicor for its use. Vicor makes no representations or warranties with respect to the accuracy or completeness of the contents of this publication. Vicor reserves the right to make changes to any products, specifications, and product descriptions at any time without notice. Information published by Vicor has been checked and is believed to be accurate at the time it was printed; however, Vicor assumes no responsibility for inaccuracies. Testing and other quality controls are used to the extent Vicor deems necessary to support Vicor's product warranty. Except where mandated by government requirements, testing of all parameters of each product is not necessarily performed.

**Specifications are subject to change without notice.**

**Vicor's Standard Terms and Conditions**

All sales are subject to Vicor's Standard Terms and Conditions of Sale, which are available on Vicor's webpage or upon request.

**Product Warranty**

In Vicor's standard terms and conditions of sale, Vicor warrants that its products are free from non-conformity to its Standard Specifications (the "Express Limited Warranty"). This warranty is extended only to the original Buyer for the period expiring two (2) years after the date of shipment and is not transferable.

UNLESS OTHERWISE EXPRESSLY STATED IN A WRITTEN SALES AGREEMENT SIGNED BY A DULY AUTHORIZED VICOR SIGNATORY, VICOR DISCLAIMS ALL REPRESENTATIONS, LIABILITIES, AND WARRANTIES OF ANY KIND (WHETHER ARISING BY IMPLICATION OR BY OPERATION OF LAW) WITH RESPECT TO THE PRODUCTS, INCLUDING, WITHOUT LIMITATION, ANY WARRANTIES OR REPRESENTATIONS AS TO MERCHANTABILITY, FITNESS FOR PARTICULAR PURPOSE, INFRINGEMENT OF ANY PATENT, COPYRIGHT, OR OTHER INTELLECTUAL PROPERTY RIGHT, OR ANY OTHER MATTER.

This warranty does not extend to products subjected to misuse, accident, or improper application, maintenance, or storage. Vicor shall not be liable for collateral or consequential damage. Vicor disclaims any and all liability arising out of the application or use of any product or circuit and assumes no liability for applications assistance or buyer product design. Buyers are responsible for their products and applications using Vicor products and components. Prior to using or distributing any products that include Vicor components, buyers should provide adequate design, testing and operating safeguards.

Vicor will repair or replace defective products in accordance with its own best judgment. For service under this warranty, the buyer must contact Vicor to obtain a Return Material Authorization (RMA) number and shipping instructions. Products returned without prior authorization will be returned to the buyer. The buyer will pay all charges incurred in returning the product to the factory. Vicor will pay all reshipment charges if the product was defective within the terms of this warranty.

**Life Support Policy**

VICOR'S PRODUCTS ARE NOT AUTHORIZED FOR USE AS CRITICAL COMPONENTS IN LIFE SUPPORT DEVICES OR SYSTEMS WITHOUT THE EXPRESS PRIOR WRITTEN APPROVAL OF THE CHIEF EXECUTIVE OFFICER AND GENERAL COUNSEL OF VICOR CORPORATION. As used herein, life support devices or systems are devices which (a) are intended for surgical implant into the body, or (b) support or sustain life and whose failure to perform when properly used in accordance with instructions for use provided in the labeling can be reasonably expected to result in a significant injury to the user. A critical component is any component in a life support device or system whose failure to perform can be reasonably expected to cause the failure of the life support device or system or to affect its safety or effectiveness. Per Vicor Terms and Conditions of Sale, the user of Vicor products and components in life support applications assumes all risks of such use and indemnifies Vicor against all liability and damages.

**Intellectual Property Notice**

Vicor and its subsidiaries own Intellectual Property (including issued U.S. and Foreign Patents and pending patent applications) relating to the products described in this data sheet. No license, whether express, implied, or arising by estoppel or otherwise, to any intellectual property rights is granted by this document. Interested parties should contact Vicor's Intellectual Property Department.

The products described on this data sheet are protected by the following U.S. Patents Numbers:

5,945,130; 6,403,009; 6,710,257; 6,788,033; 6,940,013; 6,969,909; 7,038,917; 7,154,250; 7,166,898; 7,187,263; 7,202,646; 7,361,844; 7,368,957; RE40,072; D496,906; D506,438; D509,472; and for use under 6,975,098 and 6,984,965.

**Vicor Corporation**

25 Frontage Road  
Andover, MA, USA 01810  
Tel: 800-735-6200  
Fax: 978-475-6715

**email**

Customer Service: [custserv@vicorpower.com](mailto:custserv@vicorpower.com)

Technical Support: [apps@vicorpower.com](mailto:apps@vicorpower.com)