

BWHP Series



Due to accurate wire winding technology, these chip inductors are designed for filtering, impedance matching, resonance and choke circuits for RF designer. Both standard series custom designs are available.

Features

- RoHS Compliant and Halogen Free
- Ceramic body and wire wound construction provide high Q and SRFs
- Higher Q and lower DCR than other inductors
- Exceptional current handling capability
- HP series is for high power and high frequency application

Applications

- Wireless embedded portable devices
- GPS receiver
- Base Station
- Repeater
- Set Top Box
- Cable / IP Modem
- Security system and other RF modules

Product Identification

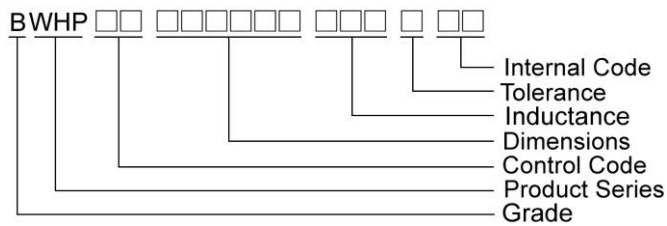

Shape and Dimensions / Recommended Pattern

BWHP00110706

BWHP00161008

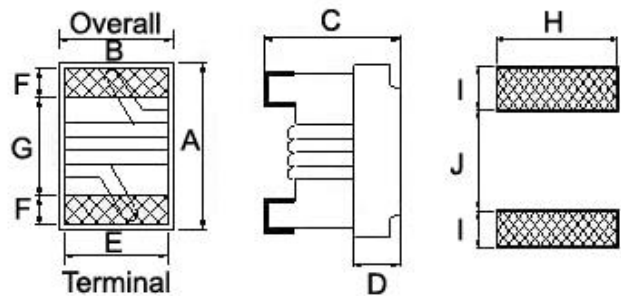
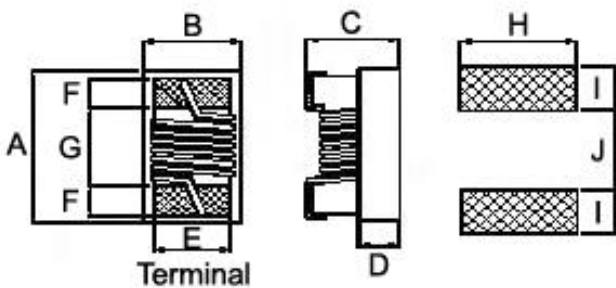

Dimensions

| | A | B | C | D | E | F | G | H | I | J |
|---------------------|-------------------------------------|-----------|--------------------------------------|------|------|------|------|------|------|------|
| BWHP00110706 | 1.1±0.05 | 0.70±0.05 | 0.6±0.05 | 0.25 | 0.45 | 0.20 | 0.54 | 0.66 | 0.36 | 0.51 |
| BWHP00161008 | 1.6 ^{+0.2} _{-0.1} | 1.00±0.1 | 0.82 ^{+0.2} _{-0.1} | 0.30 | 0.70 | 0.30 | 0.95 | 1.02 | 0.64 | 0.64 |

Shape and Dimensions / Recommended Pattern

BWHP00231715

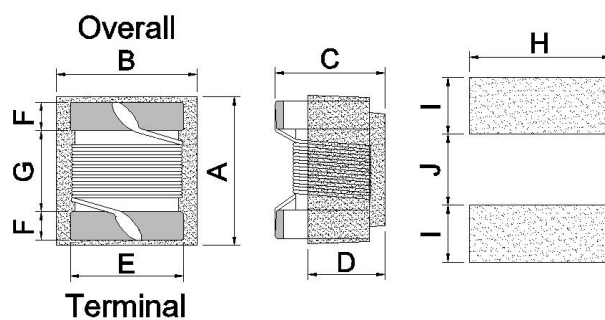

Dimensions

| | A Max | B Max | C Max | D | E | F | G | H | I | J |
|---------------------|-------|-------|-------|------|------|------|------|------|------|------|
| BWHP00231715 | 2.35 | 1.73 | 1.52 | 0.71 | 1.27 | 0.30 | 1.44 | 1.78 | 1.02 | 0.76 |

SMD Wire Wound Ceramic Chip Inductors - BWHP Series

Electrical Characteristics

| Part Number | Inductance (nH) | Tolerance (±%) | Test Frequency (MHz) | Q Typ. | Test Frequency (MHz) | SRF (GHz) Typ. | RDC (Ω) Max | Irms (mA) Max |
|--------------------|-----------------|----------------|----------------------|--------|----------------------|----------------|-------------|---------------|
| BWHP001107061N0□00 | 1.0 | ±0.1nH / 5 | 250 | 18 | 250 | 16.0 | 0.030 | 2300 |
| BWHP001107062N0□00 | 2.0 | ±0.2nH / 5 | 250 | 18 | 250 | 15.2 | 0.038 | 2100 |
| BWHP001107062N2□00 | 2.2 | ±0.2nH / 5 | 250 | 25 | 250 | 15.1 | 0.045 | 2100 |
| BWHP001107062N4□00 | 2.4 | ±0.2nH / 5 | 250 | 25 | 250 | 14.0 | 0.045 | 2000 |
| BWHP001107062N7□00 | 2.7 | ±0.2nH / 5 | 250 | 20 | 250 | 13.0 | 0.090 | 1500 |
| BWHP001107063N3□00 | 3.3 | 2 / 3 / 5 | 250 | 20 | 250 | 12.8 | 0.050 | 1700 |
| BWHP001107063N6□00 | 3.6 | 2 / 3 / 5 | 250 | 28 | 250 | 11.7 | 0.065 | 1700 |
| BWHP001107063N9□00 | 3.9 | 2 / 3 / 5 | 250 | 28 | 250 | 9.50 | 0.065 | 1700 |
| BWHP001107064N3□00 | 4.3 | 2 / 3 / 5 | 250 | 22 | 250 | 7.15 | 0.060 | 1600 |
| BWHP001107064N7□00 | 4.7 | 2 / 3 / 5 | 250 | 18 | 250 | 6.85 | 0.115 | 1500 |
| BWHP001107065N1□00 | 5.1 | 2 / 3 / 5 | 250 | 20 | 250 | 6.80 | 0.125 | 1200 |
| BWHP001107065N6□00 | 5.6 | 2 / 3 / 5 | 250 | 28 | 250 | 6.80 | 0.070 | 1600 |
| BWHP001107066N2□00 | 6.2 | 2 / 3 / 5 | 250 | 25 | 250 | 5.80 | 0.070 | 1600 |
| BWHP001107066N8□00 | 6.8 | 2 / 3 / 5 | 250 | 25 | 250 | 5.80 | 0.095 | 1500 |
| BWHP001107067N5□00 | 7.5 | 2 / 3 / 5 | 250 | 25 | 250 | 5.40 | 0.130 | 1400 |
| BWHP001107068N2□00 | 8.2 | 2 / 3 / 5 | 250 | 30 | 250 | 5.40 | 0.080 | 1500 |
| BWHP001107068N7□00 | 8.7 | 2 / 3 / 5 | 250 | 30 | 250 | 5.00 | 0.085 | 1500 |
| BWHP001107069N0□00 | 9.0 | 2 / 3 / 5 | 250 | 28 | 250 | 5.00 | 0.090 | 1400 |
| BWHP001107069N5□00 | 9.5 | 2 / 3 / 5 | 250 | 30 | 250 | 4.70 | 0.095 | 1400 |
| BWHP0011070610N□00 | 10 | 2 / 3 / 5 | 250 | 30 | 250 | 4.70 | 0.120 | 1300 |
| BWHP0011070611N□00 | 11 | 2 / 3 / 5 | 250 | 30 | 250 | 4.70 | 0.095 | 1400 |
| BWHP0011070612N□00 | 12 | 2 / 3 / 5 | 250 | 25 | 250 | 4.40 | 0.110 | 1200 |
| BWHP0011070613N□00 | 13 | 2 / 3 / 5 | 250 | 30 | 250 | 4.20 | 0.140 | 870 |
| BWHP0011070615N□00 | 15 | 2 / 3 / 5 | 250 | 30 | 250 | 3.90 | 0.130 | 1100 |
| BWHP0011070616N□00 | 16 | 2 / 3 / 5 | 250 | 30 | 250 | 3.70 | 0.150 | 850 |
| BWHP0011070618N□00 | 18 | 2 / 3 / 5 | 250 | 30 | 250 | 3.55 | 0.160 | 900 |
| BWHP0011070619N□00 | 19 | 2 / 3 / 5 | 250 | 30 | 250 | 3.50 | 0.175 | 850 |
| BWHP0011070620N□00 | 20 | 2 / 3 / 5 | 250 | 30 | 250 | 3.50 | 0.220 | 780 |
| BWHP0011070621N□00 | 21 | 2 / 3 / 5 | 250 | 30 | 250 | 1.70 | 0.360 | 450 |
| BWHP0011070622N□00 | 22 | 2 / 3 / 5 | 250 | 30 | 250 | 3.30 | 0.210 | 800 |
| BWHP0011070623N□00 | 23 | 2 / 3 / 5 | 250 | 30 | 250 | 3.15 | 0.210 | 700 |
| BWHP0011070624N□00 | 24 | 2 / 3 / 5 | 250 | 30 | 250 | 3.15 | 0.260 | 700 |
| BWHP0011070625N□00 | 25 | 2 / 3 / 5 | 250 | 30 | 250 | 3.15 | 0.310 | 700 |
| BWHP0011070626N□00 | 26 | 2 / 3 / 5 | 250 | 30 | 250 | 3.15 | 0.275 | 700 |

Note: When ordering, please specify tolerance code. Tolerance : B=±0.1nH , C=±0.2nH , G=±2% , H=±3% , J=±5%

- Operating temperature range - 40°C ~ 125°C(Including self - temperature rise)
- Irms for a 15°C temperature rise from 25°C ambient with current
- Measure Equipment :
 L & Q : Agilent E4991A+Agilent HP16197A
 SRF : Agilent HP8753D/Agilent HP8722ES
 RDC : Chroma 16502
 Irms : HP4284A+HP42841A/HP4285A+HP42841A

Please be sure to request approval specifications that provide further details of the products. Kindly note that the content of these specifications are subject to change or may be discontinued without prior notice. This product may not be designed/used in medical or high risk applications without Chilisin approval. Please contact our sales department before ordering.

SMD Wire Wound Ceramic Chip Inductors - BWHP Series

Electrical Characteristics

| Part Number | Inductance (nH) | Tolerance (±%) | Test Frequency (MHz) | Q Typ. | Test Frequency (MHz) | SRF (GHz) Typ. | RDC (Ω) Max | Irms (mA) Max |
|--------------------|-----------------|----------------|----------------------|--------|----------------------|----------------|-------------|---------------|
| BWHP0011070627N□00 | 27 | 2 / 3 / 5 | 250 | 30 | 250 | 3.20 | 0.300 | 450 |
| BWHP0011070630N□00 | 30 | 2 / 3 / 5 | 250 | 30 | 250 | 2.90 | 0.350 | 450 |
| BWHP0011070633N□00 | 33 | 2 / 3 / 5 | 250 | 30 | 250 | 2.80 | 0.380 | 490 |
| BWHP0011070636N□00 | 36 | 2 / 3 / 5 | 250 | 30 | 250 | 2.80 | 0.480 | 480 |
| BWHP0011070637N□00 | 37 | 2 / 3 / 5 | 250 | 30 | 250 | 2.70 | 0.490 | 470 |
| BWHP0011070639N□00 | 39 | 2 / 3 / 5 | 250 | 30 | 250 | 2.60 | 0.520 | 450 |
| BWHP0011070640N□00 | 40 | 2 / 3 / 5 | 250 | 30 | 250 | 2.60 | 0.520 | 450 |
| BWHP0011070643N□00 | 43 | 2 / 3 / 5 | 250 | 29 | 250 | 2.50 | 0.720 | 450 |
| BWHP0011070647N□00 | 47 | 2 / 3 / 5 | 250 | 30 | 250 | 2.40 | 0.720 | 420 |
| BWHP0011070651N□00 | 51 | 2 / 3 / 5 | 250 | 30 | 250 | 2.30 | 0.980 | 360 |

Note: When ordering, please specify tolerance code. Tolerance : B=±0.1nH , C=±0.2nH , G=±2% , H=±3% , J=±5%

- Operating temperature range - 40°C ~ 125°C(Including self - temperature rise)
- Irms for a 15°C temperature rise from 25°C ambient with current
- Measure Equipment :
 L & Q : Agilent E4991A+Agilent HP16197A
 SRF : Agilent HP8753D/Agilent HP8722ES
 RDC : Chroma 16502
 Irms : HP4284A+HP42841A/HP4285A+HP42841A

Typical **L** vs. **F** Frequency

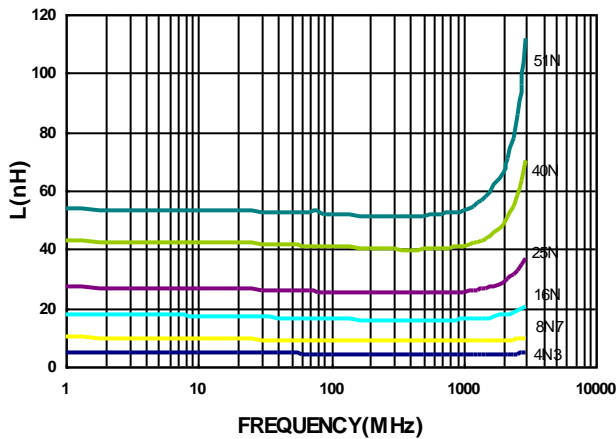

Typical **Q** vs. **F** Frequency

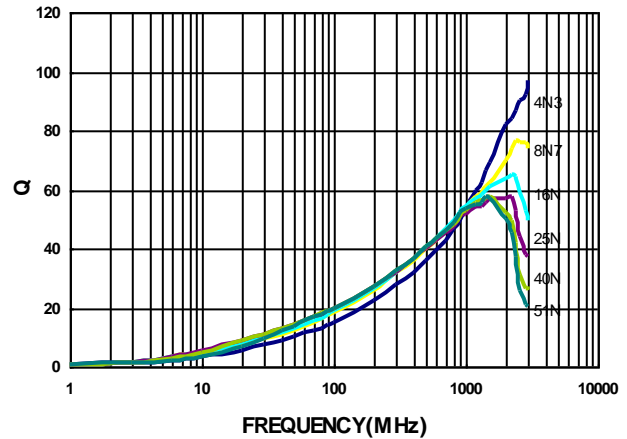

Please be sure to request approval specifications that provide further details of the products. Kindly note that the content of these specifications are subject to change or may be discontinued without prior notice. This product may not be designed/used in medical or high risk applications without Chilisin approval. Please contact our sales department before ordering.

SMD Wire Wound Ceramic Chip Inductors - BWHP Series

Electrical Characteristics

| Part Number | Inductance (nH) | Tolerance (±%) | Test Frequency (MHz) | Q Typ. | Test Frequency (MHz) | SRF (GHz) Typ. | RDC (Ω) Max | Irms (mA) Max | Color |
|--------------------|-----------------|----------------|----------------------|--------|----------------------|----------------|-------------|---------------|--------|
| BWHP001610081N8□00 | 1.8 | 5 | 250 | 23 | 250 | 16.0 | 0.033 | 2100 | Black |
| BWHP001610082N2□00 | 2.2 | 5 | 250 | 13 | 250 | 15.0 | 0.182 | 900 | Brown |
| BWHP001610083N9□00 | 3.9 | 2 / 3 / 5 | 250 | 26 | 250 | 7.50 | 0.062 | 1600 | Red |
| BWHP001610084N3□00 | 4.3 | 2 / 3 / 5 | 250 | 26 | 250 | 7.50 | 0.088 | 1300 | Orange |
| BWHP001610084N7□00 | 4.7 | 2 / 3 / 5 | 250 | 25 | 250 | 7.90 | 0.130 | 1100 | Yellow |
| BWHP001610086N8□00 | 6.8 | 2 / 3 / 5 | 250 | 40 | 250 | 5.80 | 0.065 | 1400 | Green |
| BWHP001610087N2□00 | 7.2 | 2 / 3 / 5 | 250 | 32 | 250 | 5.40 | 0.100 | 1400 | Blue |
| BWHP001610087N5□00 | 7.5 | 2 / 3 / 5 | 250 | 32 | 250 | 5.30 | 0.100 | 1300 | Violet |
| BWHP0016100811N□00 | 11 | 2 / 3 / 5 | 250 | 41 | 250 | 4.10 | 0.086 | 1400 | Gray |
| BWHP0016100815N□00 | 15 | 2 / 3 / 5 | 250 | 42 | 250 | 3.60 | 0.110 | 1200 | White |
| BWHP0016100816N□00 | 16 | 2 / 3 / 5 | 250 | 40 | 250 | 3.50 | 0.125 | 1100 | Black |
| BWHP0016100822N□00 | 22 | 2 / 3 / 5 | 250 | 40 | 250 | 3.15 | 0.195 | 850 | Brown |
| BWHP0016100823N□00 | 23 | 2 / 3 / 5 | 250 | 40 | 250 | 3.00 | 0.150 | 850 | Red |
| BWHP0016100824N□00 | 24 | 2 / 3 / 5 | 250 | 42 | 250 | 2.95 | 0.125 | 1100 | Orange |
| BWHP0016100827N□00 | 27 | 2 / 3 / 5 | 250 | 42 | 250 | 2.80 | 0.200 | 780 | Yellow |
| BWHP0016100830N□00 | 30 | 2 / 3 / 5 | 250 | 49 | 250 | 2.80 | 0.130 | 920 | Green |
| BWHP0016100833N□00 | 33 | 2 / 3 / 5 | 250 | 45 | 250 | 2.70 | 0.170 | 680 | Blue |
| BWHP0016100836N□00 | 36 | 2 / 3 / 5 | 250 | 44 | 250 | 2.50 | 0.225 | 720 | Violet |
| BWHP0016100839N□00 | 39 | 2 / 3 / 5 | 250 | 48 | 250 | 2.45 | 0.190 | 680 | Gray |
| BWHP0016100843N□00 | 43 | 2 / 3 / 5 | 250 | 45 | 250 | 2.45 | 0.225 | 810 | White |
| BWHP0016100847N□00 | 47 | 2 / 3 / 5 | 200 | 43 | 250 | 2.30 | 0.240 | 680 | Black |
| BWHP0016100851N□00 | 51 | 2 / 3 / 5 | 200 | 42 | 250 | 2.30 | 0.280 | 660 | Brown |
| BWHP0016100856N□00 | 56 | 2 / 3 / 5 | 200 | 43 | 250 | 2.20 | 0.300 | 610 | Red |
| BWHP0016100868N□00 | 68 | 2 / 3 / 5 | 200 | 43 | 250 | 2.00 | 0.330 | 600 | Orange |
| BWHP0016100872N□00 | 72 | 2 / 3 / 5 | 150 | 37 | 250 | 1.90 | 0.420 | 550 | Yellow |
| BWHP0016100875N□00 | 75 | 2 / 3 / 5 | 150 | 37 | 250 | 1.90 | 0.520 | 500 | Green |
| BWHP0016100882N□00 | 82 | 2 / 3 / 5 | 150 | 38 | 250 | 1.80 | 0.460 | 510 | Blue |
| BWHP0016100891N□00 | 91 | 2 / 3 / 5 | 150 | 45 | 250 | 1.65 | 0.580 | 440 | Violet |
| BWHP00161008R10□00 | 100 | 2 / 3 / 5 | 150 | 49 | 250 | 1.70 | 0.540 | 470 | Gray |
| BWHP00161008R11□00 | 110 | 2 / 3 / 5 | 150 | 47 | 250 | 1.60 | 0.620 | 440 | White |
| BWHP00161008R12□00 | 120 | 2 / 3 / 5 | 150 | 47 | 250 | 1.55 | 0.720 | 420 | Black |
| BWHP00161008R15□00 | 150 | 2 / 3 / 5 | 150 | 47 | 250 | 1.35 | 1.150 | 390 | Brown |

Note: When ordering, please specify tolerance code. Tolerance : G=±2% ,H=±3% , J=±5%

- Operating temperature range - 40°C ~ 125°C(Including self - temperature rise)
- Irms for a 15°C temperature rise from 25°C ambient with current
- Measure Equipment :
 L & Q : Agilent E4991A+Agilent HP16197A
 SRF : Agilent HP8753D/Agilent HP8722ES
 RDC : Chroma 16502
 Irms : HP4284A+HP42841A/HP4285A+HP42841A

Please be sure to request approval specifications that provide further details of the products. Kindly note that the content of these specifications are subject to change or may be discontinued without prior notice. This product may not be designed/used in medical or high risk applications without Chilisin approval. Please contact our sales department before ordering.

SMD Wire Wound Ceramic Chip Inductors - BWHP Series

Electrical Characteristics

| Part Number | Inductance (nH) | Tolerance (±%) | Test Frequency (MHz) | Q Typ. | Test Frequency (MHz) | SRF (GHz) Typ. | RDC (Ω) Max | I _{rms} (mA) Max | Color |
|--------------------|-----------------|----------------|----------------------|--------|----------------------|----------------|-------------|---------------------------|--------|
| BWHP00161008R18□00 | 180 | 2 / 3 / 5 | 100 | 48 | 250 | 1.30 | 1.500 | 310 | Red |
| BWHP00161008R20□00 | 200 | 2 / 3 / 5 | 100 | 47 | 250 | 1.25 | 2.000 | 280 | Orange |
| BWHP00161008R21□00 | 210 | 2 / 3 / 5 | 100 | 48 | 250 | 1.20 | 2.000 | 280 | Yellow |
| BWHP00161008R22□00 | 220 | 2 / 3 / 5 | 100 | 47 | 250 | 1.10 | 2.000 | 280 | Green |
| BWHP00161008R25□00 | 250 | 2 / 3 / 5 | 100 | 45 | 250 | 1.05 | 3.000 | 240 | Blue |
| BWHP00161008R27□00 | 270 | 2 / 3 / 5 | 100 | 46 | 250 | 1.05 | 2.250 | 260 | Violet |
| BWHP00161008R30□00 | 300 | 2 / 3 / 5 | 100 | 47 | 250 | 0.99 | 2.800 | 220 | Gray |
| BWHP00161008R33□00 | 330 | 2 / 3 / 5 | 100 | 46 | 250 | 0.93 | 3.600 | 180 | White |
| BWHP00161008R36□00 | 360 | 2 / 3 / 5 | 100 | 47 | 250 | 0.93 | 4.000 | 170 | Black |
| BWHP00161008R39□00 | 390 | 2 / 3 / 5 | 100 | 47 | 250 | 0.88 | 4.000 | 170 | Brown |

Note: When ordering, please specify tolerance code. Tolerance : G=±2% , H=±3% , J=±5%

- Operating temperature range - 40°C ~ 125°C(Including self - temperature rise)
- I_{rms} for a 15°C temperature rise from 25°C ambient with current
- Measure Equipment :
 L & Q : Agilent E4991A+Agilent HP16197A
 SRF : Agilent HP8753D/Agilent HP8722ES
 RDC : Chroma 16502
 I_{rms} : HP4284A+HP42841A/HP4285A+HP42841A

Typical **L** vs. **F**requency

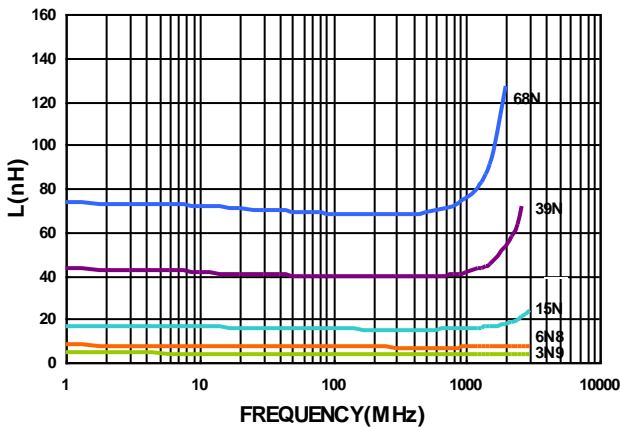

Typical **Q** vs. **F**requency

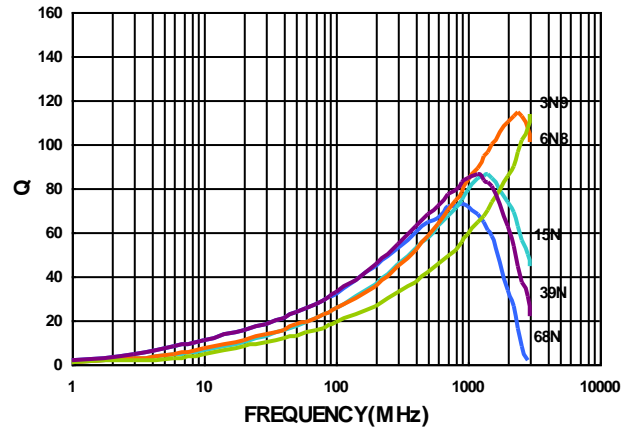

Please be sure to request approval specifications that provide further details of the products. Kindly note that the content of these specifications are subject to change or may be discontinued without prior notice. This product may not be designed/used in medical or high risk applications without Chilisin approval. Please contact our sales department before ordering.

SMD Wire Wound Ceramic Chip Inductors - BWHP Series

Electrical Characteristics

| Part Number | Inductance (nH) | Tolerance (±%) | Test Frequency (MHz) | Q Typ. | Test Frequency (MHz) | SRF (MHz) Typ. | RDC (Ω) Max | Irms (mA) Typ |
|--------------------|-----------------|----------------|----------------------|--------|----------------------|----------------|-------------|---------------|
| BWHP002317152N6□00 | 2.6 | 5 | 250 | 100 | 1500 | 9500 | 0.015 | 2000 |
| BWHP002317156N2□00 | 6.2 | 5 | 250 | 104 | 1000 | 7200 | 0.027 | 1500 |
| BWHP002317156N8□00 | 6.8 | 5 | 250 | 90 | 1000 | 6000 | 0.066 | 1300 |
| BWHP0023171511N□00 | 11 | 2 / 5 | 250 | 93 | 500 | 4750 | 0.039 | 1600 |
| BWHP0023171512N□00 | 12 | 2 / 5 | 250 | 91 | 500 | 4425 | 0.039 | 1400 |
| BWHP0023171513N□00 | 13 | 2 / 5 | 250 | 91 | 500 | 4100 | 0.039 | 1400 |
| BWHP0023171518N□00 | 18 | 2 / 5 | 250 | 95 | 500 | 3650 | 0.050 | 1200 |
| BWHP0023171533N□00 | 33 | 2 / 5 | 250 | 100 | 500 | 2410 | 0.087 | 1100 |
| BWHP0023171547N□00 | 47 | 2 / 5 | 200 | 105 | 500 | 2170 | 0.093 | 1000 |
| BWHP0023171556N□00 | 56 | 2 / 5 | 200 | 100 | 500 | 1815 | 0.122 | 950 |
| BWHP0023171582N□00 | 82 | 2 / 5 | 150 | 103 | 500 | 1525 | 0.168 | 820 |
| BWHP00231715R10□00 | 100 | 2 / 5 | 150 | 100 | 500 | 1400 | 0.220 | 720 |
| BWHP00231715R12□00 | 120 | 2 / 5 | 150 | 80 | 250 | 1265 | 0.293 | 620 |
| BWHP00231715R15□00 | 150 | 2 / 5 | 100 | 80 | 250 | 1150 | 0.288 | 600 |
| BWHP00231715R18□00 | 180 | 2 / 5 | 100 | 77 | 250 | 1025 | 0.374 | 540 |
| BWHP00231715R22□00 | 220 | 2 / 5 | 100 | 75 | 250 | 930 | 0.426 | 500 |
| BWHP00231715R27□00 | 270 | 2 / 5 | 100 | 75 | 250 | 830 | 0.754 | 420 |
| BWHP00231715R33□00 | 330 | 2 / 5 | 100 | 54 | 100 | 770 | 1.004 | 360 |
| BWHP00231715R39□00 | 390 | 2 / 5 | 100 | 52 | 100 | 700 | 1.110 | 330 |
| BWHP00231715R47□00 | 470 | 2 / 5 | 50 | 52 | 100 | 640 | 1.559 | 280 |
| BWHP00231715R56□00 | 560 | 2 / 5 | 25 | 46 | 100 | 550 | 2.067 | 240 |
| BWHP00231715R68□00 | 680 | 2 / 5 | 25 | 46 | 100 | 535 | 2.355 | 210 |
| BWHP00231715R82□00 | 820 | 2 / 5 | 25 | 50 | 100 | 485 | 3.945 | 180 |

Note: When ordering, please specify tolerance code. Tolerance : G=±2% , J=±5%

- Operating temperature range - 40°C ~ 125°C(Including self - temperature rise)
- I rms for a 15°C temperature rise from 25°C ambient with current
- Measure Equipment :
 L & Q : Agilent E4991A+Agilent HP16197A
 SRF : Agilent HP8753D/Agilent HP8722ES
 RDC : Chroma 16502
 I rms : HP4284A+HP42841A/HP4285A+HP42841A

Typical L vs. Frequency

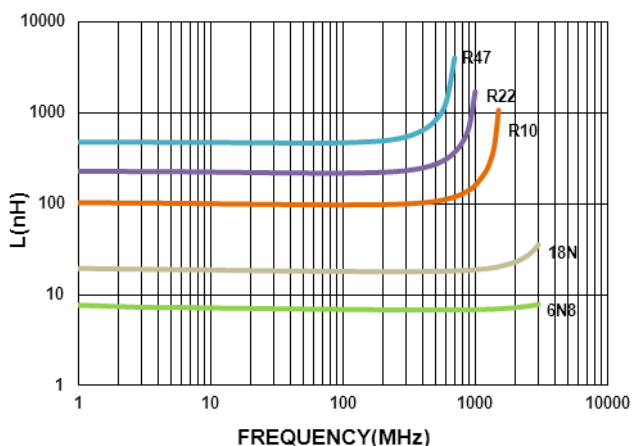

Typical Q vs. Frequency

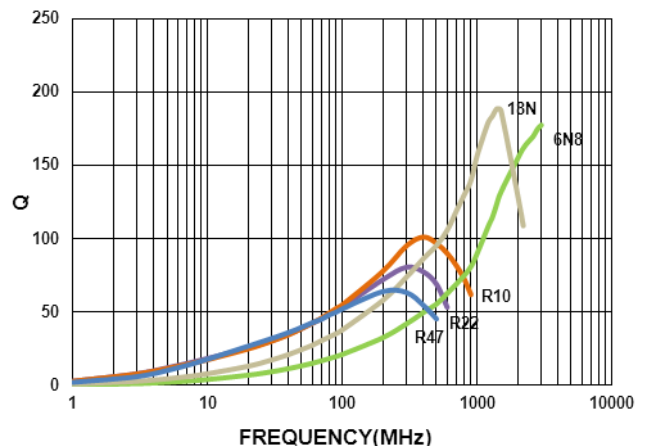

Please be sure to request approval specifications that provide further details of the products. Kindly note that the content of these specifications are subject to change or may be discontinued without prior notice. This product may not be designed/used in medical or high risk applications without Chilisin approval. Please contact our sales department before ordering.

SMD Wire Wound Ceramic Chip Inductors - BWHP Series

Packaging Specifications

Tape Dimensions

Figure 1

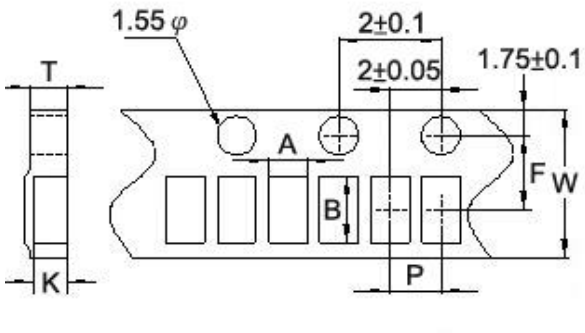

Tape Material

Carrier Tape: Paper
Cover Tape: Polystyrene

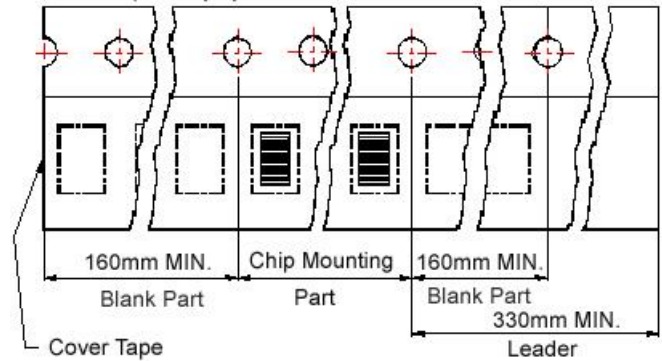
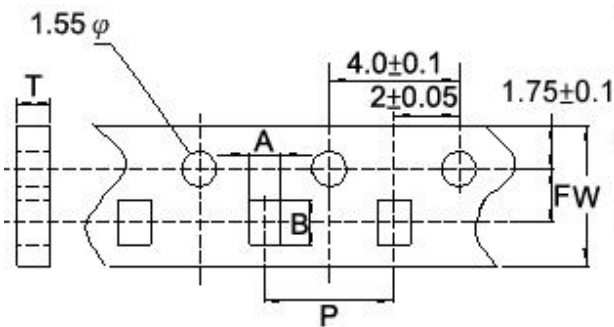

Figure 2



Carrier Tape: Paper
Cover Tape: Polystyrene

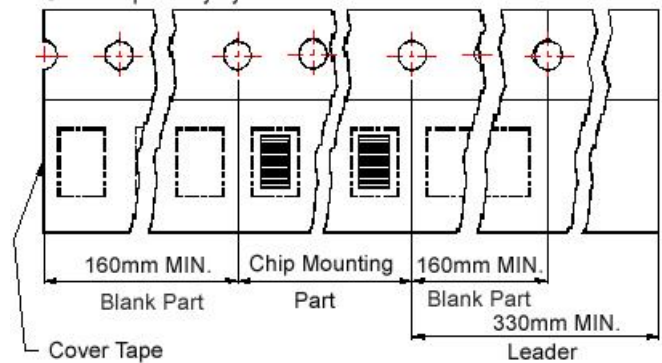
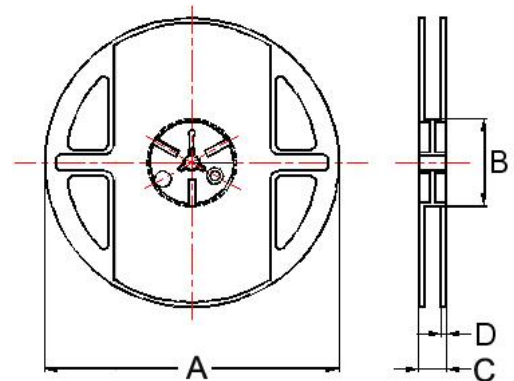
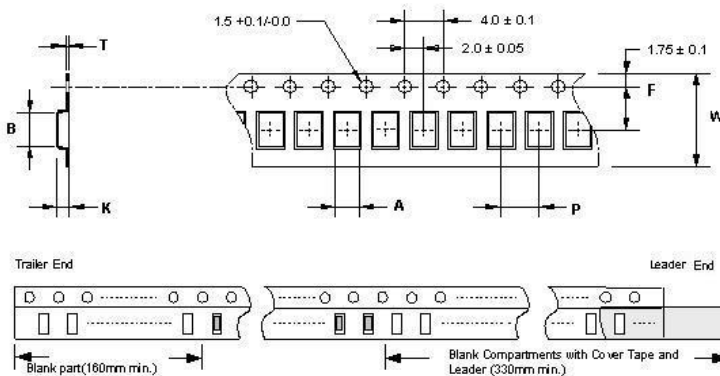

Figure 3

Reel Dimensions



Dimensions in mm

| TYPE | Fig. | Tape Dimensions | | | | | | | Reel Dimensions | | | | Quantity PCS / Reel |
|---------------|------|-----------------|------|------|---|---|-----|------|-----------------|----|----|-----|------------------------|
| | | A | B | T | W | P | F | K | A | B | C | D | |
| BWHP001110706 | 1 | 0.80 | 1.20 | 0.75 | 8 | 2 | 3.5 | 0.62 | 178 | 60 | 12 | 1.5 | 4000 |
| BWHP00161008 | 2 | 1.23 | 1.90 | 1.05 | 8 | 4 | 3.5 | - | 178 | 60 | 12 | 1.5 | 4000 |
| BWHP00231715 | 3 | 1.85 | 2.45 | 0.23 | 8 | 4 | 3.5 | 1.50 | 178 | 60 | 12 | 1.5 | 2000 |