



# 698-960, 1710-2700 MHz LTE ANTENNA

Part Numbers: 2195890-1

## FEATURES & BENEFITS

- 2G, 3G, 4G, NB-IoT, LoRa, Sigfox, Wi-Fi 2.4, ZigBee, Bluetooth
- External chassis mount antenna
- ROHS compliant

## SPECIFICATIONS

Frequency Range (MHz)	698-960	1710-2700
VSWR	< 3.7:1	< 2.2:1
Average Efficiency	62%	64%
Peak Gain	3.2dBi	3.9dBi
Average Gain	-2.2dBi	-2.0dBi
Power Handling	10 Watt cw	
Feed Point Impedance	50 ohms	
Polarization	Linear	
Size	115.0mm x ø 10.0 (mm)	
Weight	< 17.2 g	
Mounting	Terminal mount	
Mating Connector	SMA Female	
Cable	N/A	
Operating Temperature	-40 to +85°C	
Storage Temperature	-40 to +85°C	
Hazardous Materials	A certificate of conformance is available from the product page on TE website.	

## RF DATA

### VSWR

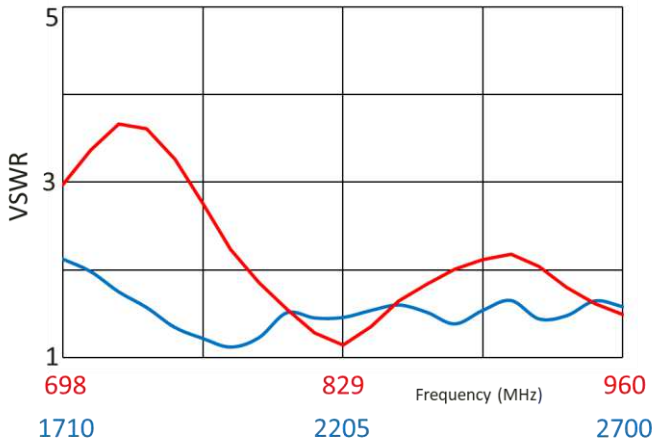

### Return Loss

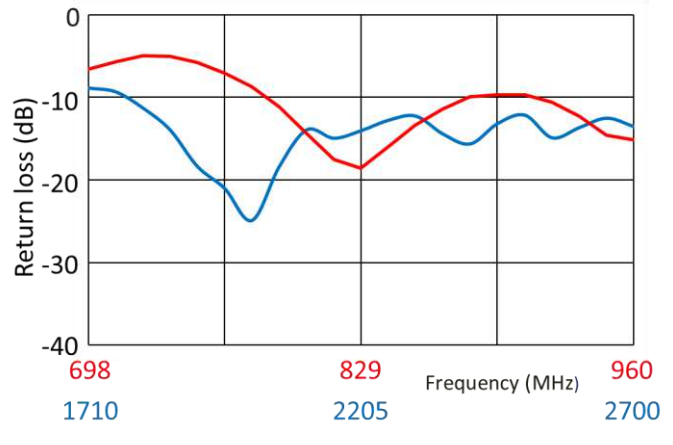

### Efficiency

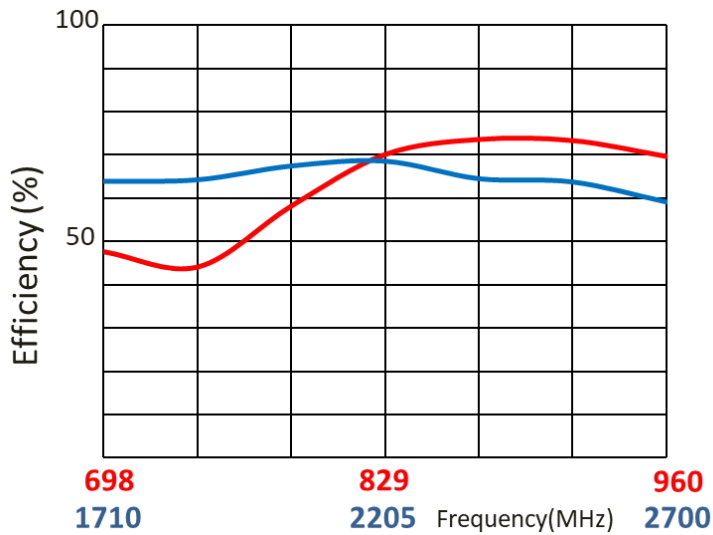

# RADIATION PATTERN

## Test setup

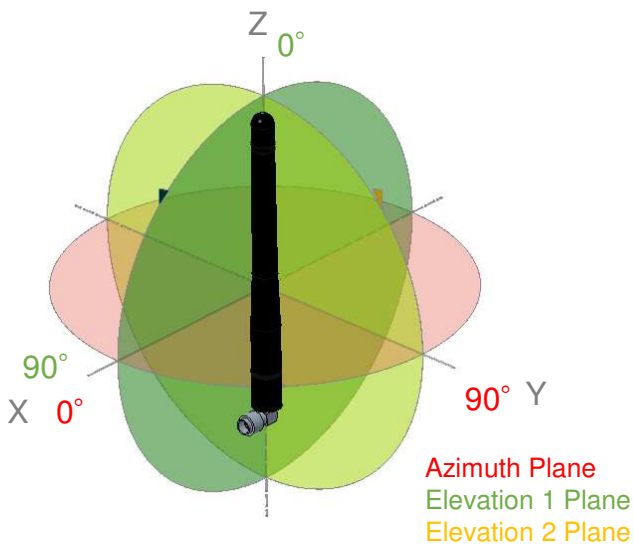

## Azimuth

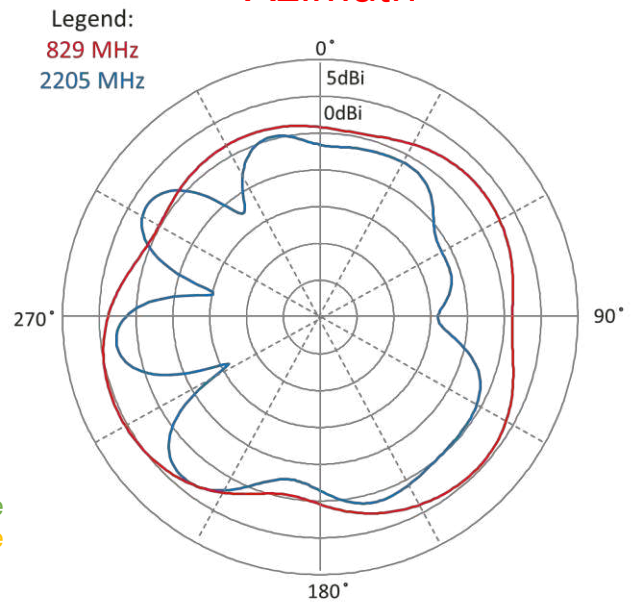

## Elevation 1

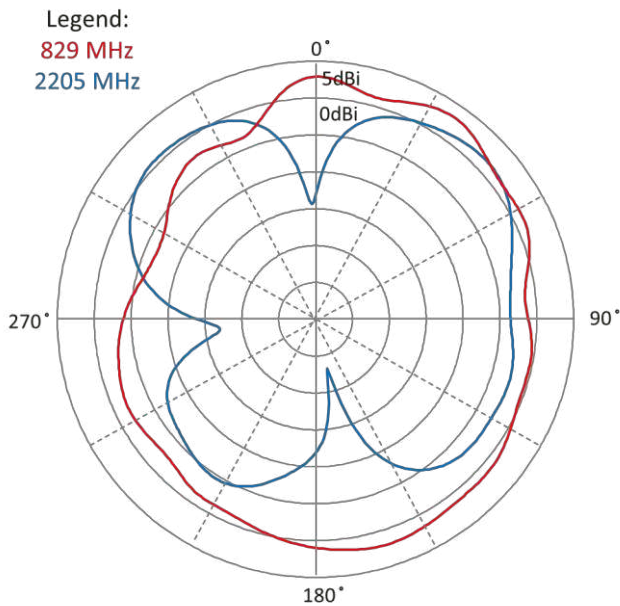

## Elevation 2

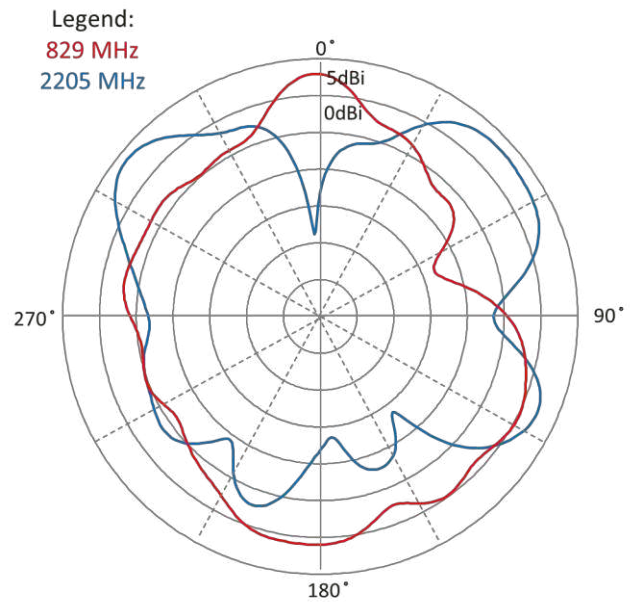

# 698-960, 1710-2700 MHz EXTERNAL ANTENNA

Standard Antenna Solutions

## DIMENSIONS

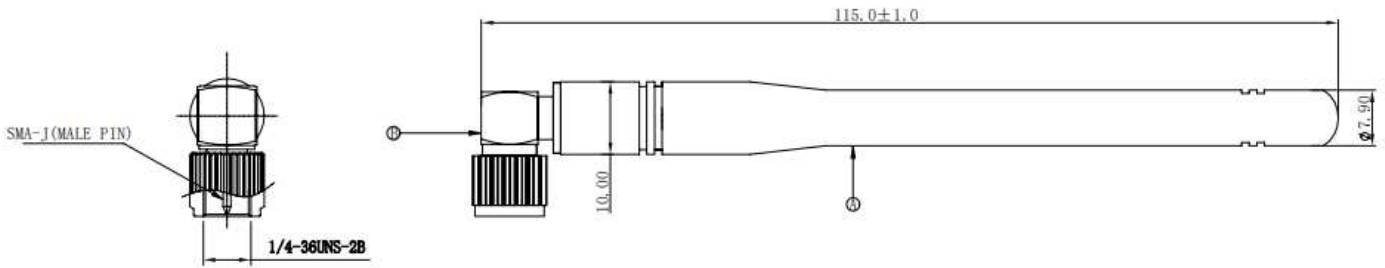

Dimensions: mm  
Diagram is not to scale

# 698-960, 1710-2700 MHz EXTERNAL ANTENNA

Standard Antenna Solutions

## PACKAGING

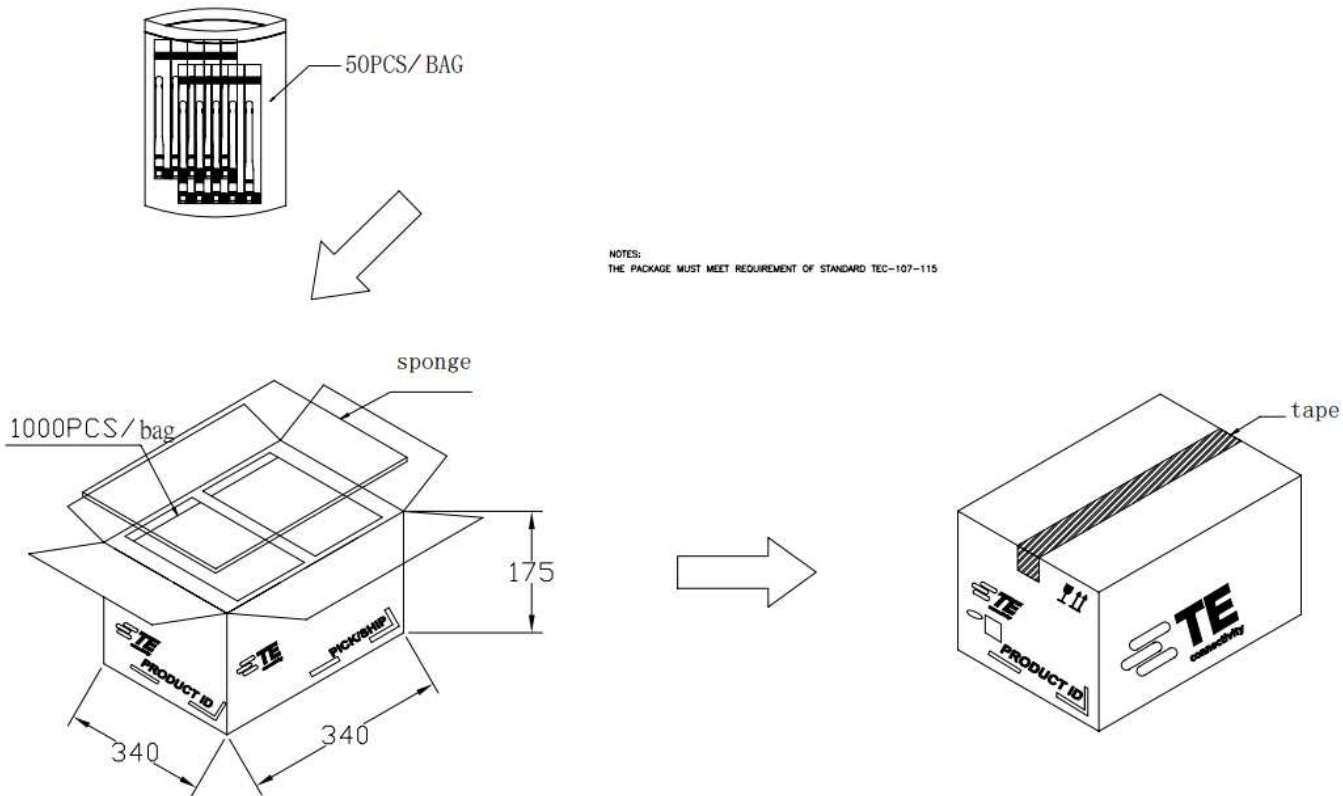

### TE TECHNICAL SUPPORT CENTER

- USA: +1 (800) 522-6752
- Canada: +1 (905) 475-6222
- Mexico: +52 (0) 55-1106-0800
- Latin/S. America: +54 (0) 11-4733-2200
- Germany: +49 (0) 6251-133-1999
- UK: +44 (0) 800-267666
- France: +33 (0) 1-3420-8686
- Netherlands: +31 (0) 73-6246-999
- China: +86 (0) 400-820-6015

For phone numbers in other countries, go to [te.com/support-center](http://te.com/support-center)

### te.com

TE Connectivity, TE Connectivity (logo) are trademarks. All other logos, products and/or company names referred to herein might be trademarks of their respective owners.

The information given herein, including drawings, illustrations and schematics which are intended for illustration purposes only, is believed to be reliable. However, TE Connectivity makes no warranties as to its accuracy or completeness and disclaims any liability in connection with its use. TE Connectivity's obligations shall only be as set forth in TE Connectivity's Standard Terms and Conditions of Sale for this product and in no case will TE Connectivity be liable for any incidental, indirect or consequential damages arising out of the sale, resale, use or misuse of the product. Users of TE Connectivity products should make their own evaluation to determine the suitability of each such product for the specific application.

© 2020 TE Connectivity Ltd. family of companies All Rights Reserved.

02/2021