

DATASHEET

UJ3D1250K

50A -1200V SiC Schottky Diode

Rev. D, May 2020

Description

UnitedSiC offers the 3rd generation of high performance SiC Merged-PiN-Schottky (MPS) diodes. With zero reverse recovery charge and 175°C maximum junction temperature, these diodes are ideally suited for high frequency and high efficiency power systems with minimum cooling requirements.

Features

- ◆ Maximum operating temperature of 175°C
- ◆ Easy paralleling
- ◆ Extremely fast switching not dependent on temperature
- ◆ No reverse or forward recovery
- ◆ Enhanced surge current capability, MPS structure
- ◆ 100% UIS tested
- ◆ AEC-Q101 qualified

Typical applications

- ◆ Power converters
- ◆ Industrial motor drives
- ◆ Switch mode power supplies
- ◆ Power factor correction modules

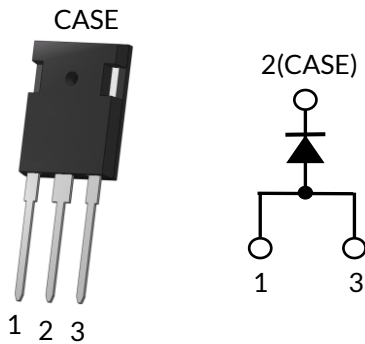

Part Number	Package	Marking
UJ3D1250K	TO-247-3L	UJ3D1250K



Maximum Ratings

Parameter	Symbol	Test Conditions	Value	Units
DC blocking voltage	V_R		1200	V
Repetitive peak reverse voltage, $T_J=25^\circ\text{C}$	V_{RRM}		1200	V
Surge peak reverse voltage	V_{RSM}		1200	V
Maximum DC forward current	I_F	$T_C = 112^\circ\text{C}$	50	A
Non-repetitive forward surge current sine halfwave	I_{FSM}	$T_C = 25^\circ\text{C}, t_p = 10\text{ms}$	275	A
Repetitive forward surge current sine halfwave, $D=0.1$	I_{FRM}	$T_C = 25^\circ\text{C}, t_p = 10\text{ms}$	163.5	A
		$T_C = 110^\circ\text{C}, t_p = 10\text{ms}$	99.6	
Non-repetitive peak forward current	$I_{F,max}$	$T_C = 25^\circ\text{C}, t_p = 10\mu\text{s}$	2400	A
		$T_C = 110^\circ\text{C}, t_p = 10\mu\text{s}$	2400	
i^2t value	$\int i^2 dt$	$T_C = 25^\circ\text{C}, t_p = 10\text{ms}$	378	A^2s
Power dissipation	P_{tot}	$T_C = 25^\circ\text{C}$	319	W
		$T_C = 112^\circ\text{C}$	134	
Maximum junction temperature	$T_{J,max}$		175	$^\circ\text{C}$
Operating and storage temperature	T_J, T_{STG}		-55 to 175	$^\circ\text{C}$
Soldering temperatures, wavesoldering only allowed at leads	T_{sold}	1.6mm from case for 10s	260	$^\circ\text{C}$

Thermal Characteristics

Parameter	Symbol	Test Conditions	Value			Units
			Min	Typ	Max	
Thermal resistance, junction-to-case	$R_{\theta JC}$			0.36	0.47	$^\circ\text{C}/\text{W}$

Electrical Characteristics ($T_J = +25^\circ\text{C}$ unless otherwise specified)

Parameter	Symbol	Test Conditions	Value			Units
			Min	Typ	Max	
Forward voltage	V_F	$I_F = 50\text{A}, T_J = 25^\circ\text{C}$	-	1.5	1.7	V
		$I_F = 50\text{A}, T_J = 150^\circ\text{C}$	-	1.95	2.4	
		$I_F = 50\text{A}, T_J = 175^\circ\text{C}$	-	2.2	2.7	
Reverse current	I_R	$V_R = 1200\text{V}, T_J = 25^\circ\text{C}$	-	52	400	μA
		$V_R = 1200\text{V}, T_J = 175^\circ\text{C}$	-	900		
Total capacitive charge ⁽¹⁾	Q_C	$V_R = 800\text{V}$		240		nC
Total capacitance	C	$V_R = 1\text{V}, f = 1\text{MHz}$		2340		pF
		$V_R = 400\text{V}, f = 1\text{MHz}$		224		
		$V_R = 800\text{V}, f = 1\text{MHz}$		198		
Capacitance stored energy	E_C	$V_R = 800\text{V}$		72		μJ

(1) Q_C is independent on T_J , di_F/dt , and I_F as shown in the application note USCi_AN0011.

Typical Performance Diagrams

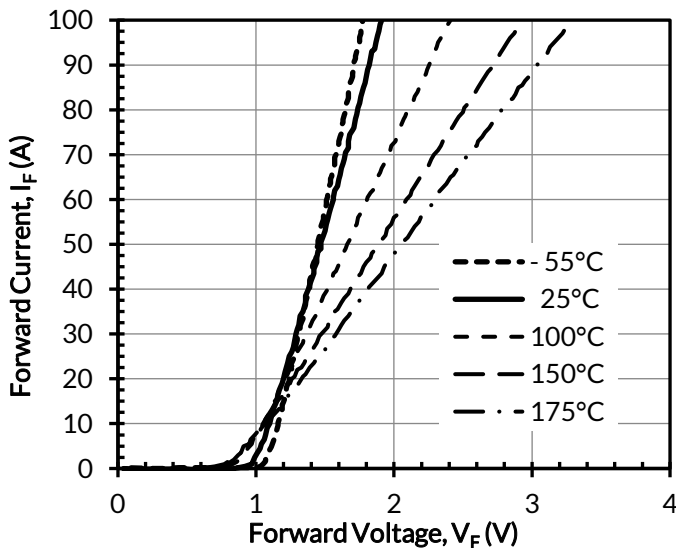

Figure 1. Typical forward characteristics

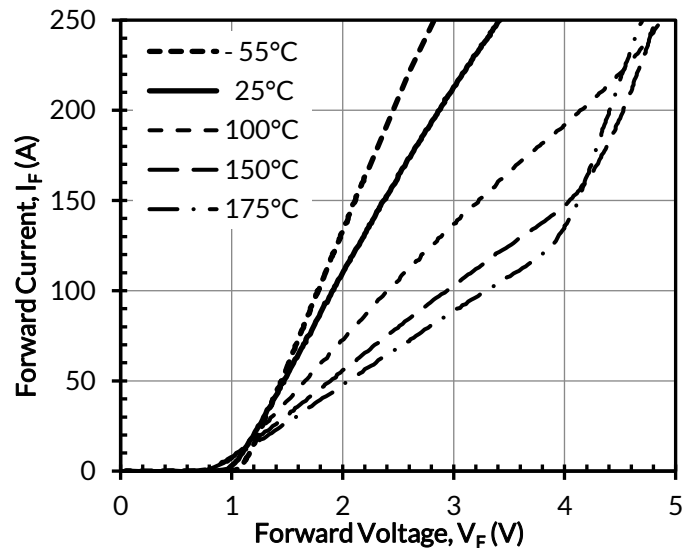

Figure 2. Typical forward characteristics in surge current

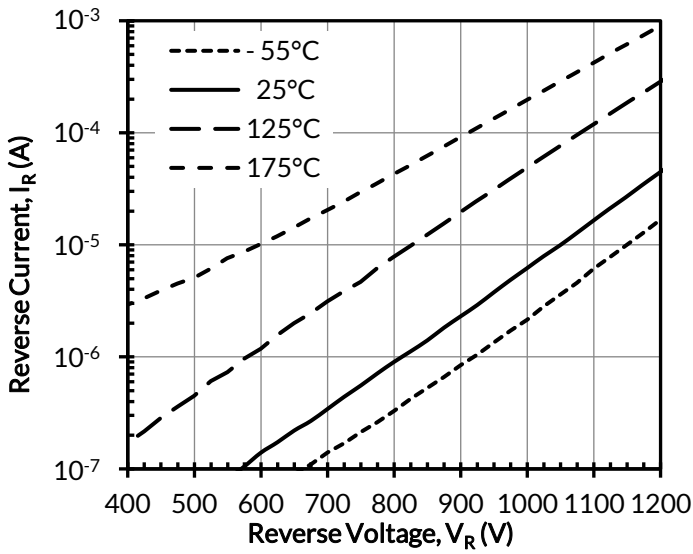

Figure 3. Typical reverse characteristics

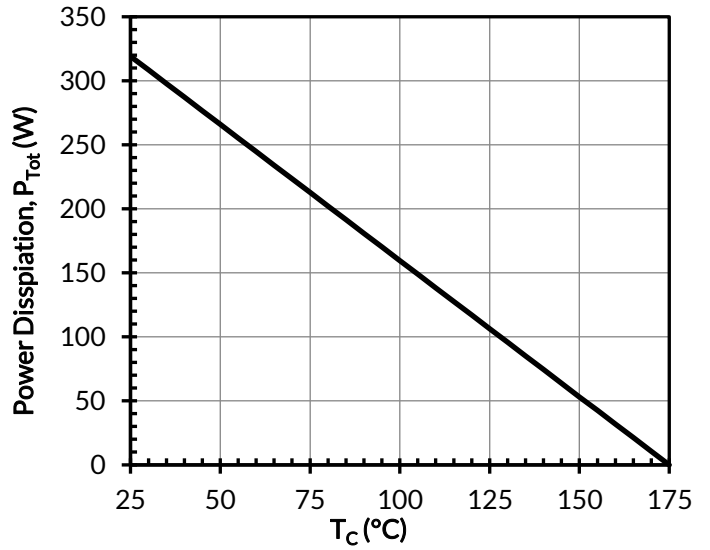

Figure 4. Power dissipation

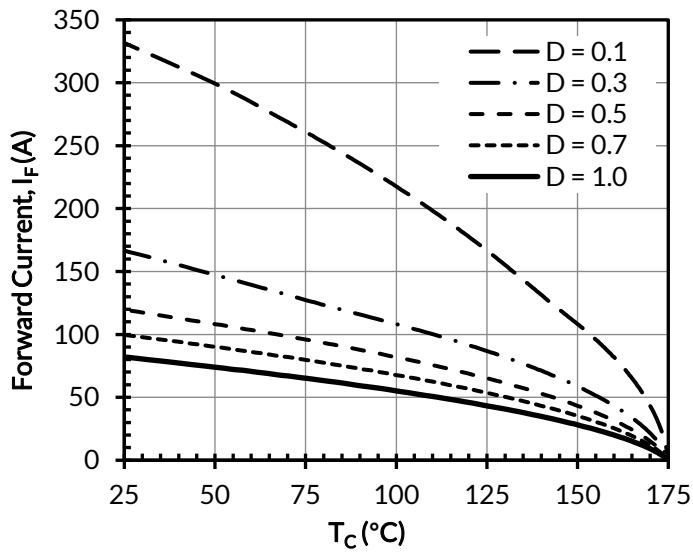

Figure 5. Diode forward current

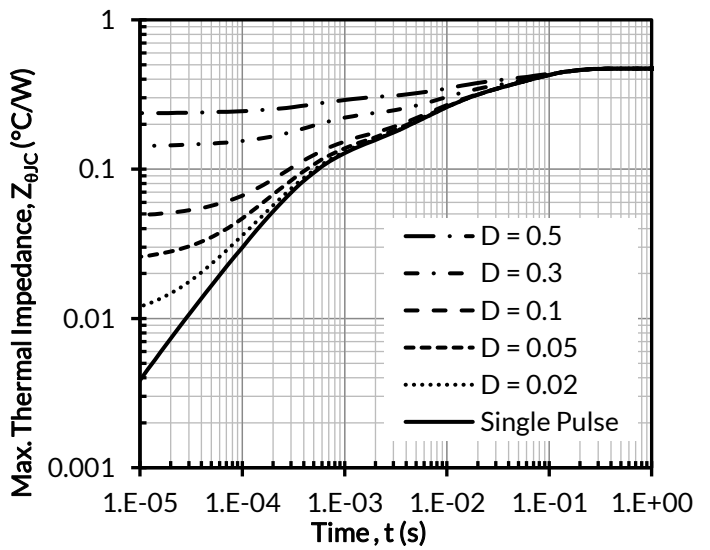

Figure 6. Maximum transient thermal impedance

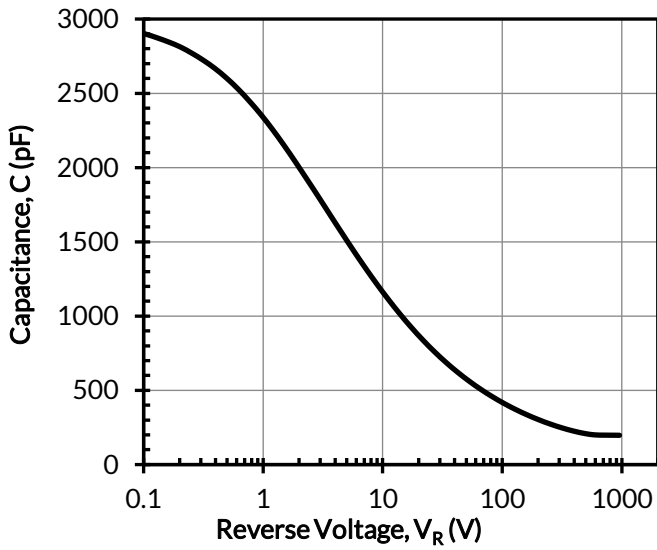

Figure 7. Capacitance vs. reverse voltage at 1MHz

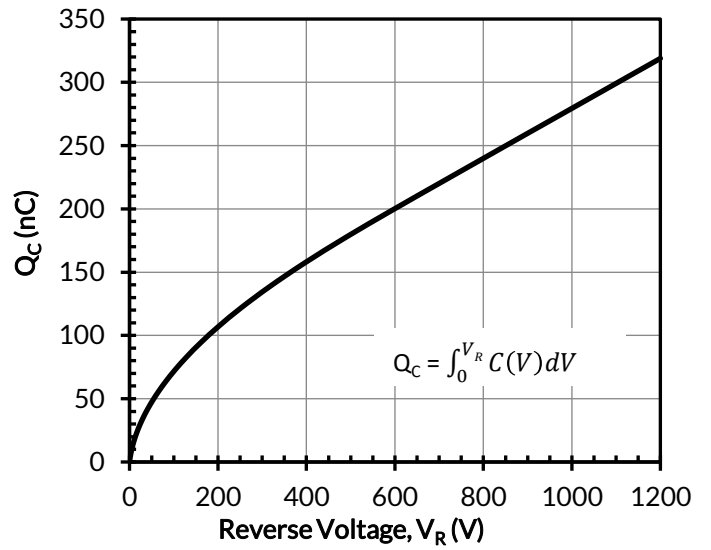

Figure 8. Typical capacitive charge vs. reverse voltage

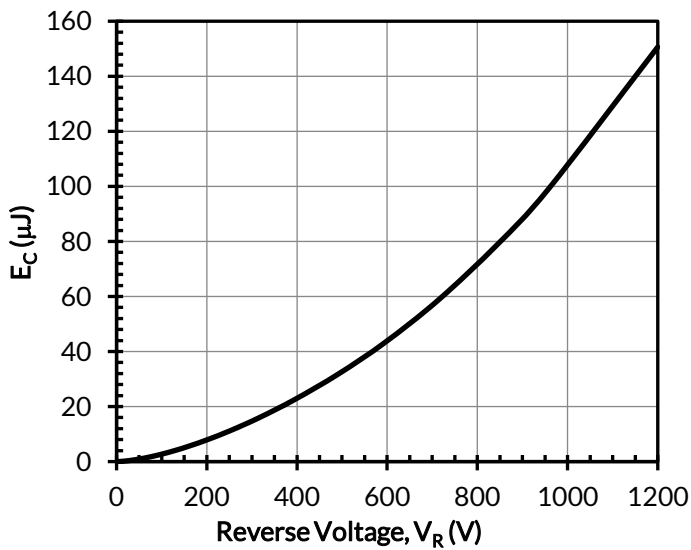

Figure 9. Typical capacitance stored energy vs. reverse voltage

Disclaimer

UnitedSiC reserves the right to change or modify any of the products and their inherent physical and technical specifications without prior notice. UnitedSiC assumes no responsibility or liability for any errors or inaccuracies within.

Information on all products and contained herein is intended for description only. No license, express or implied, to any intellectual property rights is granted within this document.

UnitedSiC assumes no liability whatsoever relating to the choice, selection or use of the UnitedSiC products and services described herein.