

Data sheet | Item number: 218-517

PCB terminal block; Locking slides; 0.5 mm²; Pin spacing 2.54 mm; 17-pole;
CAGE CLAMP®; 0,50 mm²; gray



www.wago.com/218-517



i Picture differs from the item.

Color:

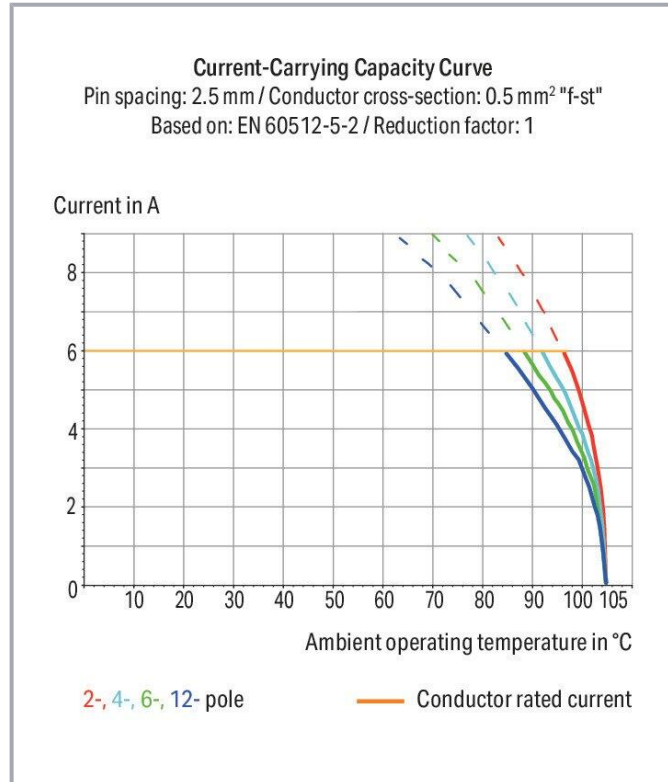

Subject to changes. Please also observe the further product documentation!

WAGO GmbH & Co. KG
Hansastr. 27
32423 Minden
Phone: +49571 887-0 | Fax: +49571 887-169
Email: info.de@wago.com | Web: www.wago.com

Do you have any questions about our products?
We are always happy to take your call at +49 (571) 887-44222.

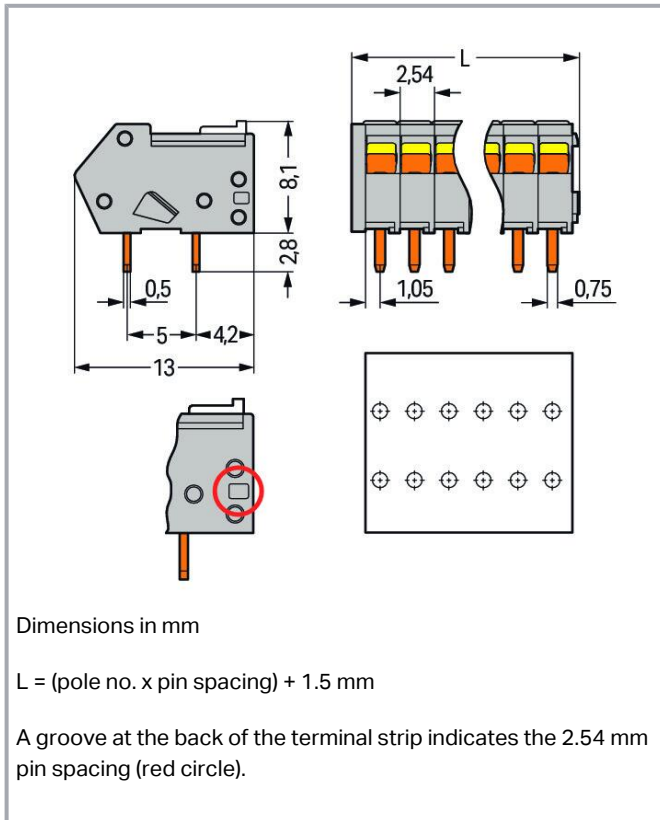

Item description

- Terminal strips are just 8.1 mm tall and feature an innovative, locking slide-actuated CAGE CLAMP®.
- Several clamping units can be held open simultaneously.
- Easily terminate stranded conductors in tight spaces (e.g., bus connectors).

Data

Notes

Variants:

Other pole numbers

Other colors

Mixed-color PCB connector strips

Direct marking

Other versions (or variants) can be requested from WAGO Sales or configured at <https://configurator.wago.com/>.

Electrical data

Subject to changes. Please also observe the further product documentation!

WAGO GmbH & Co. KG

Hansastr. 27

32423 Minden

Phone: +49571 887-0 | Fax: +49571 887-169

Email: info.de@wago.com | Web: www.wago.com

Do you have any questions about our products?

We are always happy to take your call at +49 (571) 887-44222.

Ratings per IEC/EN

| | |
|-------------------------------|---|
| Ratings per | IEC/EN 60664-1 |
| Nominal voltage (III/3) | 80 V |
| Rated impulse voltage (III/3) | 2.5 kV |
| Rated voltage (III/2) | 160 V |
| Rated impulse voltage (III/2) | 2.5 kV |
| Nominal voltage (II/2) | 320 V |
| Rated surge voltage (II/2) | 2.5 kV |
| Rated current | 6 A |
| Legend (ratings) | (III / 2) ≙ Overvoltage category III / Pollution degree 2 |

Ratings per UL 1059

| | |
|--------------------------------|---------|
| Approvals per | UL 1059 |
| Rated voltage UL (Use Group B) | 150 V |
| Rated current UL (Use Group B) | 4 A |

Ratings per CSA

| | |
|---------------------------------|-------|
| Approvals per | CSA |
| Rated voltage CSA (Use Group B) | 150 V |
| Rated current CSA (Use Group B) | 4 A |

Connection data

| | |
|----------------------------|----|
| Connection points | 17 |
| Total number of potentials | 17 |
| Number of connection types | 1 |
| Number of levels | 1 |

Connection 1

| | |
|---|--|
| Connection technology | CAGE CLAMP® |
| Actuation type | Slider |
| Solid conductor | 0.08 ... 0.5 mm ² / 28 ... 20 AWG |
| Fine-stranded conductor | 0.08 ... 0.5 mm ² / 28 ... 20 AWG |
| Fine-stranded conductor; with insulated ferrule | 0.25 mm ² |
| Fine-stranded conductor; with uninsulated ferrule | 0.25 mm ² |
| Note (conductor cross-section) | Terminating 0.75 mm ² /18 AWG conductors is possible; however insulation diameter allows only every other clamping unit to be |

Subject to changes. Please also observe the further product documentation!



terminated with this conductor size.

| | |
|---------------------------------------|----------------------------------|
| Strip length | 5 ... 6 mm / 0.2 ... 0.24 inches |
| Conductor connection direction to PCB | 40 ° |
| Pole number | 17 |

Physical data

| | |
|--------------------------------------|--------------------------|
| Pin spacing | 2.54 mm / 0.1 inches |
| Width | 44.68 mm / 1.759 inches |
| Height | 10.9 mm / 0.429 inches |
| Height from the surface | 8.1 mm / 0.319 inches |
| Depth | 13 mm / 0.512 inches |
| Solder pin length | 2.8 mm |
| Solder pin dimensions | 0.5 x 0.75 mm |
| Drilled hole diameter with tolerance | 1.1 ^(+0.1) mm |

Plug-in connection

| | |
|--------------------------------------|----|
| Plugging without loss of pin spacing | No |
|--------------------------------------|----|

PCB contact

| | |
|-------------------------------------|--|
| PCB contact | THT |
| Solder pin arrangement | over the entire terminal strip (in-line) |
| Number of solder pins per potential | 2 |

Material Data

| | |
|-----------------------------|--|
| Note (material data) | Information on material specifications can be found here |
| Color | gray |
| Material group | I |
| Insulation material | Polyamide (PA66) |
| Flammability class per UL94 | V0 |
| Clamping spring material | Chrome-nickel spring steel (CrNi) |
| Contact material | Electrolytic copper (E _{Cu}) |
| Contact plating | Tin |
| Fire load | 0.275 MJ |
| Weight | 5.5 g |

Subject to changes. Please also observe the further product documentation!

WAGO GmbH & Co. KG
 Hansastr. 27
 32423 Minden
 Phone: +49571 887-0 | Fax: +49571 887-169
 Email: info.de@wago.com | Web: www.wago.com

Do you have any questions about our products?
 We are always happy to take your call at +49 (571) 887-44222.

Environmental requirements

| | |
|-------------------------|-----------------|
| Limit temperature range | -60 ... +105 °C |
|-------------------------|-----------------|

Commercial data





| | |
|-----------------------|--------------------------------|
| Product Group | 4 (Printed Circuit Connectors) |
| eCl@ss 10.0 | 27-44-04-01 |
| eCl@ss 9.0 | 27-44-04-01 |
| ETIM 8.0 | EC002643 |
| ETIM 7.0 | EC002643 |
| PU (SPU) | 100 (25) pcs |
| Packaging type | box |
| Country of origin | PL |
| GTIN | 4045454332617 |
| Customs tariff number | 85369010000 |

Environmental Product Compliance



| | |
|------------------------|-------------------------|
| RoHS Compliance Status | Compliant, No Exemption |
|------------------------|-------------------------|

Approvals / Certificates



General approvals

| Logo | Approval | Additional Approval Text | Certificate name |
|--|---------------------------------|--------------------------|------------------|
|  | CCA DEKRA Certification B.V. | EN 60947 | NTR NL-7076 |
|  | CCA DEKRA Certification B.V. | EN 60947-7-4 | NTR NL-7785 |
|  | CCA DEKRA Certification B.V. | EN 60947-7-4 | 77-111038 |
|  | CSA DEKRA Certification B.V. | C22.2 No. 158 | 1565656 |

Subject to changes. Please also observe the further product documentation!



| | | | |
|--|-------------------------------------|----------|------------|
|  | ENEC DEKRA Certification B.V. | EN 60947 | 2160584.01 |
|  | UL UL International Germany GmbH | UL 1059 | E45172 |

Declarations of conformity and manufacturer's declarations

| Logo | Approval | Additional Approval Text | Certificate name |
|--|--|--------------------------|------------------|
|  | EU-Declaration of Conformity WAGO GmbH & Co. KG | - | - |
|  | UK-Declaration of Conformity WAGO GmbH & Co. KG | - | - |

Optional accessories



Tool

| Operating tool | | |
|--|---|--|
|  | Item no.: 210-648 Operating tool; Blade: 2.5 x 0.4 mm; with a partially insulated shaft; angled; short | www.wago.com/210-648 |
|  | Item no.: 210-719 Operating tool; Blade: 2.5 x 0.4 mm; with a partially insulated shaft | www.wago.com/210-719 |



Testing and measuring

| Testing accessories | | |
|--|--|--|
|  | Item no.: 735-500 WAGO Test pin; 1 mm Ø; 30 V AC / 60 V DC; CAT0; 1 A; 6 mm uninsulated; Test lead for soldering up to 0,5mm² | www.wago.com/735-500 |

Ferrule

| Ferrule | | |
|---|---|--|
|  | Item no.: 216-131 Ferrule; Sleeve for 0.25 mm² / AWG 24; uninsulated; electro-tin plated; silver-colored | www.wago.com/216-131 |
|  | Item no.: 216-151 Ferrule; Sleeve for 0.25 mm² / AWG 24; uninsulated; electro-tin plated | www.wago.com/216-151 |

Subject to changes. Please also observe the further product documentation!

| | | |
|---|--|--|
|  | Item no.: 216-301 Ferrule; Sleeve for 0.25 mm ² / AWG 24; insulated; electro-tin plated; yellow | www.wago.com/216-301 |
|  | Item no.: 216-321 Ferrule; Sleeve for 0.25 mm ² / AWG 24; insulated; electro-tin plated; yellow | www.wago.com/216-321 |

Marking accessories

| Marking strip | | |
|--|---|--|
|  | Item no.: 210-331/254-204 Marking strips; as a DIN A4 sheet; MARKED; 17-32 (400x); Height of marker strip: 2.3 mm/0.091 in; Strip length 182 mm; Horizontal marking; Self-adhesive; white | www.wago.com/210-331/254-204 |
|  | Item no.: 210-331/254-206 Marking strips; as a DIN A4 sheet; MARKED; 33-48 (400x); Height of marker strip: 2.3 mm/0.091 in; Strip length 182 mm; Horizontal marking; Self-adhesive; white | www.wago.com/210-331/254-206 |
|  | Item no.: 210-331/254-202 Marking strips; as a DIN A4 sheet; MARKED; 1-16 (400x); Height of marker strip: 2.3 mm/0.091 in; Strip length 182 mm; Horizontal marking; Self-adhesive; white | www.wago.com/210-331/254-202 |
|  | Item no.: 210-331/254-207 Marking strips; as a DIN A4 sheet; MARKED; 1-48 (100x); Height of marker strip: 2.3 mm/0.091 in; Strip length 182 mm; Horizontal marking; Self-adhesive; white | www.wago.com/210-331/254-207 |

Downloads

Documentation

Additional Information

| | | | |
|------------------------|------------|--------|----------|
| Technical Section | 2019 Apr 3 | pdf | Download |
| Technical explanations | | 2.0 MB | |

CAD/CAE-Data

CAD data

| | | |
|----------------------|-----|----------|
| 2D/3D Models 218-517 | URL | Download |
|----------------------|-----|----------|

CAE data

| | | |
|---------------------------|-----|----------|
| EPLAN Data Portal 218-517 | URL | Download |
|---------------------------|-----|----------|

| | | |
|----------------------|-----|----------|
| ZUKEN Portal 218-517 | URL | Download |
|----------------------|-----|----------|

PCB Design

| | | |
|------------------------------|-----|----------|
| Symbol and Footprint 218-517 | URL | Download |
|------------------------------|-----|----------|

Subject to changes. Please also observe the further product documentation!



CAX data for your PCB design, consisting of "schematic symbols and PCB footprints", allow easy integration of the WAGO component into your development environment.

Supported formats:

- Accel EDA 14 & 15
- Altium 6 to current version
- Cadence Allegro
- DesignSpark
- Eagle Libraries
- KiCad
- Mentor Graphics BoardStation
- Mentor Graphics Design Architect
- Mentor Graphics Design Expedition 99 and 2000
- OrCAD 9.X PCB and Capture
- PADS PowerPCB 3, 3.5, 4.X, and 5.X
- PADS PowerPCB and PowerLogic 3.0
- PCAD 2000, 2001, 2002, 2004, and 2006
- Pulsonix 8.5 or newer
- STL
- 3D STEP
- TARGET 3001!
- View Logic ViewDraw
- Quadcept
- Zuken CadStar 3 and 4
- Zuken CR-5000 and CR-8000

PCB Component Libraries (EDA), PCB CAD Library Ultra Librarian

Environmental Product Compliance

Compliance Search

Environmental Product Compliance 218-517

[URL](#)

[Download](#)

PCB terminal block; Locking slides; 0.5 mm²; Pin spacing 2.54 mm; 17-pole; CAGE CLAMP®; 0,50 mm²; gray

Installation Notes

Conductor termination

Subject to changes. Please also observe the further product documentation!

WAGO GmbH & Co. KG
Hansastr. 27
32423 Minden
Phone: +49571 887-0 | Fax: +49571 887-169
Email: info.de@wago.com | Web: www.wago.com

Do you have any questions about our products?
We are always happy to take your call at +49 (571) 887-44222.

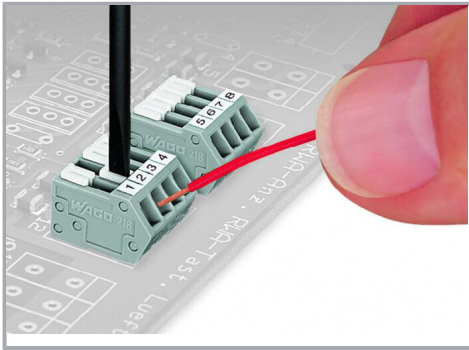

Terminating stranded conductors in confined spaces requires a great deal of patience, unless you use the new 218 Series PCB Terminal Strips. The clamping units of these strips can be held open during termination process via integrated locking slide.

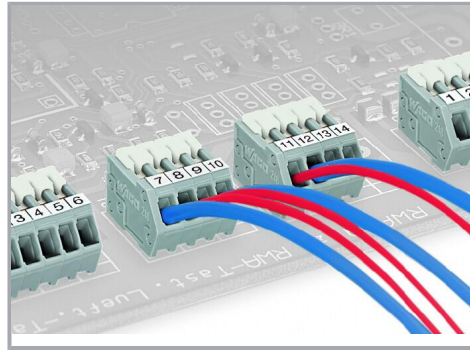

Terminating 0.75 mm²/18 AWG conductors is possible; however insulation diameter allows only every other clamping unit to be terminated with this conductor size.

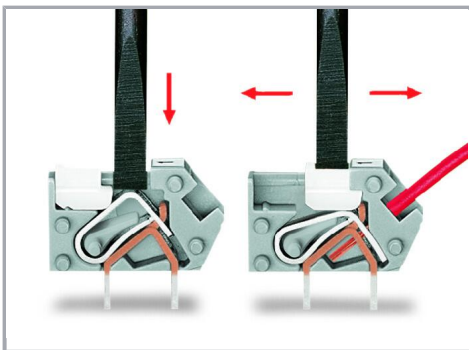

Conductor termination: To momentarily open the clamping unit, use screwdriver and then insert a stripped conductor. To open clamping unit for an extended period, move locking slide toward conductor entry hole. Then fully insert stripped conductor and move locking slide back to original position (also possible to perform with fingernail).

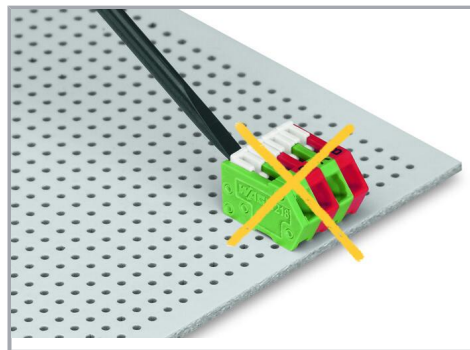

Incorrect – do not operate the locking slides from the back.

Marking

Subject to changes. Please also observe the further product documentation!

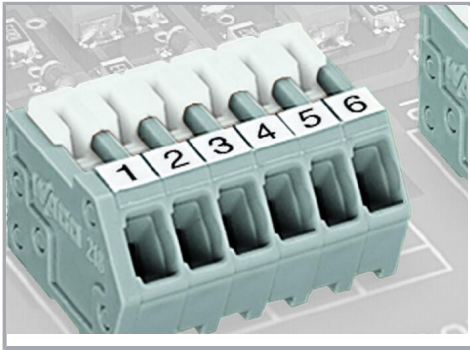

Labeling with self-adhesive marking strips.

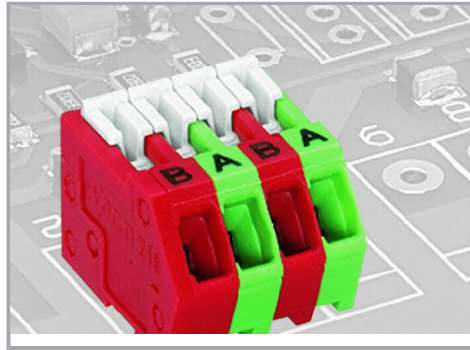

Labeling via factory direct marking.

Testing

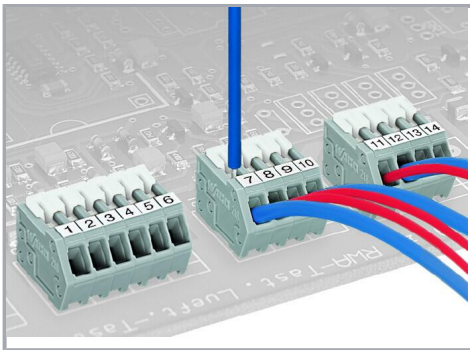

Testing directly on the clamping spring.

Subject to changes. Please also observe the further product documentation!