

ONLY FOR REFERENCE

Standard Spec Sheet

Mitsumi Model Name	SOG-152ANT
Mitsumi Model No.	R 66 7834
Operating Force	1.6N
Pcs/Reel	10,000

This specification is only for reference. If you have any questions for the details, please contact SW engineering division.
For your adopting the products, the formal supply specification will be provided.

MITSUMI ELECTRIC CO.,LTD.

2-11-2, Tsurumaki, Tama-shi. Tokyo 206-8657 Japan.

SWITCH ENGINEERING SECTION

1049, Tateiwa, Iizuka-shi. Fukuoka 820-8533 Japan.

10	7834 File No.	Specification Tactile switches SOG-152ANT		Approved Nov-06-15 SW ENG. Hirahata	Checked Nov-06-15 SW ENG. Kawaguchi	Drawn Nov-06-15 SW ENG. Higaki
		Customer's Name -	Customer's Parts No. -	General Specification S66-1797	Issued Nov-06-15	

- 1) The items stipulated in this specification are prior to the "General Specification".
- 2) When not stipulated in this specification the items "General Specification" are applied.

RoHS Compliant
(2011/65/EU)

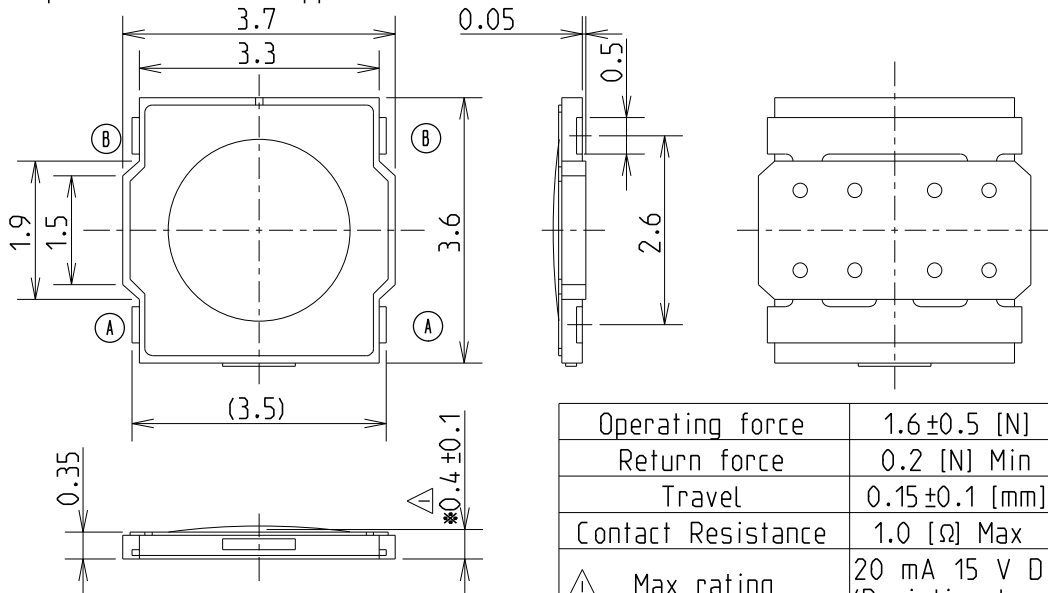

Operating force	1.6±0.5 [N]
Return force	0.2 [N] Min
Travel	0.15±0.1 [mm]
Contact Resistance	1.0 [Ω] Max
△ Max rating	20 mA 15 V DC (Resistive Load)
△ Operating Life	1,000,000 Cycles

*The switch height shall be measured with applying 15gram load

Reference land dimension

The thickness of solder stencil: 100μm

Refer-1
Bottom soldering

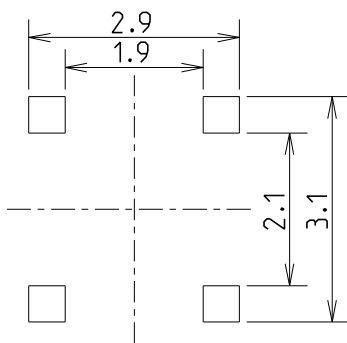

It's possible to minimize the mounting area, but not possible to confirm solder fillet.

Refer-2
Normal land pattern

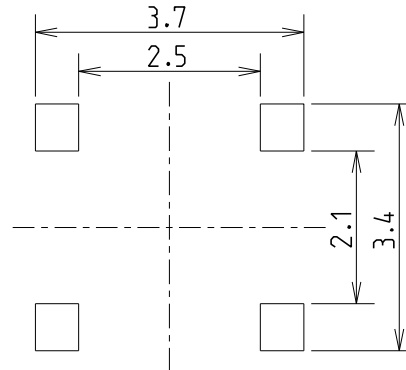

It's possible to confirm solder fillet.

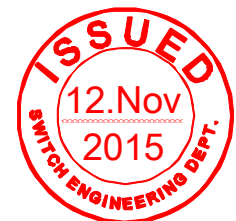

Circuit Diagram

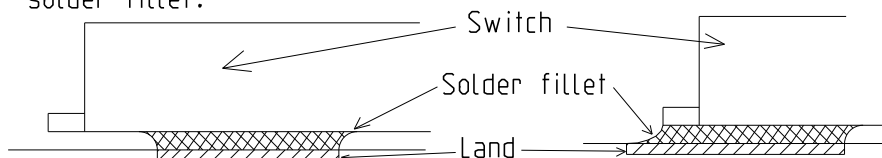
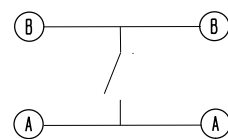

Environmental classification	G
Parameter sheet result	N
Development Class	2

Revision				Third Angle Projection	Scale	Tolerance	Ass'y Drwg. No.
	△ x4	Corrected Error	Nov-10-15		Higaki	10:1	±0.15
	QA process flow chart	Product Inspection standard	Model Code	Code	Indent.No.	File No.	
	Q66-0788	166-8522	1462	R 66		7834	01

1797

General specification
Tactile switches
SOG series

Approved Nov-10-15 SW eng. Hirahata	Checked Nov-10-15 SW eng. Kawaguchi	Drawn Nov-10-15 SW eng. Higaki
Released	Nov-10-15	

1. General

1.1. Application

This specification is applied to Tactile switches named SOG series.

1.2. Operating temperature range: -40 to +60 deg-C

1.3. Storage temperature range: -25 to +85 deg-C (Product level)
-20 to +50 deg-C (Taped condition)

1.4. Test conditions

Normal temperature; 5 to 35 deg-C, normal humidity; 45 to 85% RH.

If any doubt arises from judgement, tests and measurements shall be conducted under the following conditions.

Temperature 20+/- 2deg-C, humidity 65+/-5% RH, and air pressure 86 to 106 kPa.

2. Appearance and Construction

2.1. Dimensions: Specified on Product specifications.

2.2. Materials: Refer to Table-1.

2.3. Appearance: There shall be no defects that affect the performance of the products such as crack, scratch, dirt, discoloration

2.4. Cross section view:

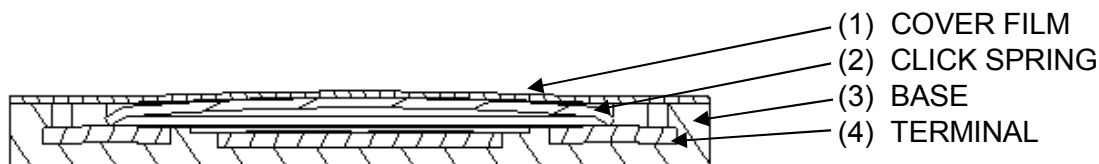

Fig. 1: Cross section of product

Table-1

Components	Material	Note
(1) COVER FILM	Polyimide	
(2) CLICK SPRING	Stainless steel	Ni+Ag plated
(3) BASE	LCP	
(4) TERMINAL	Phosphor bronze	Ni+Ag plated

3. Rating

Specified on Product specification.

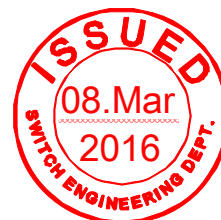

Revision					Code	Division	File No.	
					S	66	1797	

4. Electric Characteristics

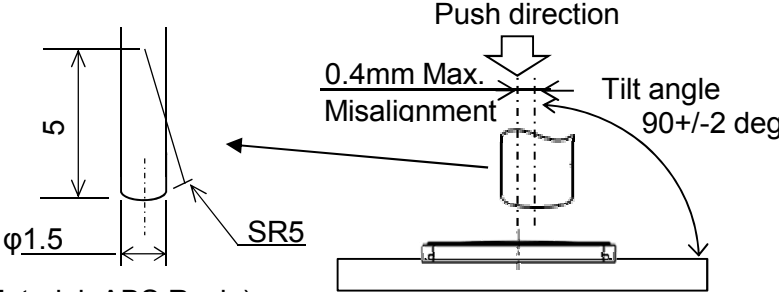
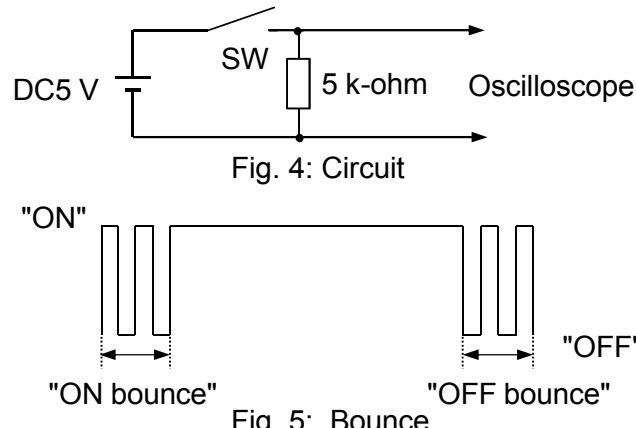
Item	Test conditions	Criteria
4.1. Contact resistance	Measurements shall be made under the conditions shown in Fig. 3. 1) Load: 1.5~2 times of the specified standard operating force. 2) Measuring method : To be measured with max. 20 mV, 100 mA  (Material: ABS Resin) Fig. 2: Push rod Fig. 3: Measurement conditions	Specified on Product specifications.
4.2. Insulation resistance	Measurements shall be made under the following conditions. 1) Applied voltage: 100 V, DC 2) Duration: 1 min. 3) Applied position: Between terminals.	10 M-ohm Min.
4.3. Withstanding voltage	Measurements shall be made under the following conditions. 1) Applied voltage: 100 V, AC (50/60 Hz) 2) Duration: 1 min. 3) Leak current: 2 mA 4) Applied position: Between terminals.	There shall be no damage and breakdown.
4.4. Bounce	Measurements shall be made under the conditions shown in Fig. 3. Bounce time at "ON" and "OFF" shall be measured under the following conditions. 1) Circuit: Refer to Fig. 4. 2) Load: 1.5 times of the specified standard operating force. 3) Frequency of operation: 3 to 4 times/sec.  Fig. 4: Circuit Fig. 5: Bounce	ON bounce: 10 ms Max. OFF bounce: 10 ms Max.

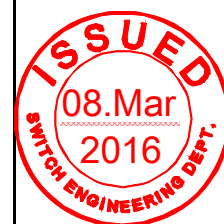

File number

1797

5. Mechanical Characteristics

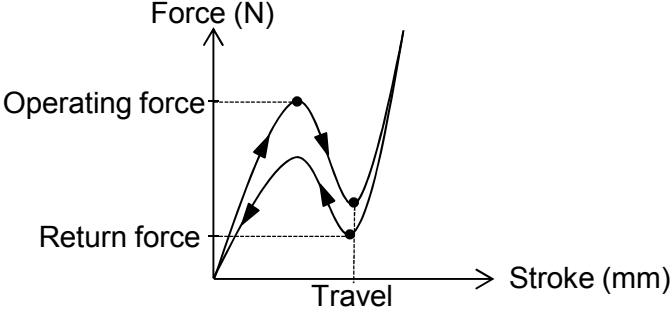
Item	Test conditions	Criteria
5.1. Operating force 5.2. Return force 5.3. Travel	Measurements shall be made under the conditions shown in Fig. 3 just after striking 10 times lightly. 1) Measurement speed: 0.5 mm/sec. 2) Limit load to apply: 1.5 to 2 times of the specified standard operating force.  Fig. 6: Force-Stroke curve	Specified on Product specifications.
5.4. Stopper strength	Measurements shall be made under the conditions shown in Fig. 3 and at returned condition. Load: 30 N Duration: 15 sec.	There shall be no electrical and mechanical abnormality.
5.5. Impact resistance	Measurements shall be made after testing under the following conditions. 1) Acieration: 735 m/s ² 2) Duration: 6 msec 3) Test direction: 6 directions 4) Number of test: 3 times per direction (18 times in total)	There shall be no electrical and mechanical abnormality.
5.6. Vibration resistance	Measurements shall be made after testing under the following conditions. 1) Vibration frequency range: 10 to 55 Hz 2) Amplitude: 1.5 mm (peak-to-peak) 3) Sweep ratio: 10-55-10 Hz in approx. 1 min. 4) Frequency sweep mode: Logarithmic or Liner sweep 5) Direction of vibration: 3 orthogonal directions including the direction of operation. 6) Duration: 2 hr each (6 hr in total)	There shall be no electrical and mechanical abnormality.
5.7. Solderability	Measurements shall be made under the following conditions. 1) Solder temperature: 230 +/- 5 dig-C 2) Dipping time: 3 +/- 0.5 sec. 3) Composition of solder: Sn-3.0Ag-0.5Cu 4) Soldering flux: Rosin 25%, Alcohol 75%	More than 75% of dipped part shall be covered with solder.

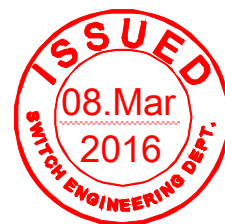

File number

1797

5. Mechanical Characteristics

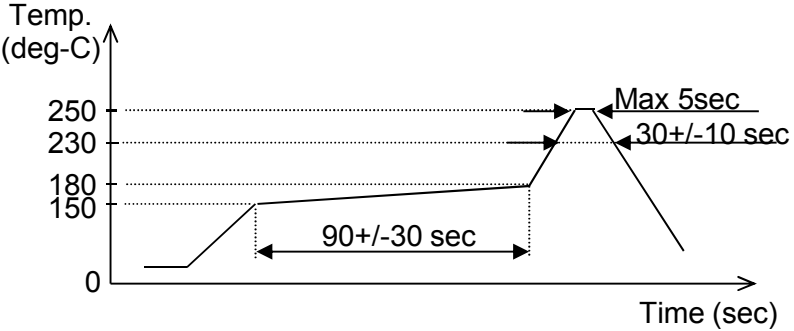
Item	Test conditions	Criteria
5.8. Soldering heat resistance	1) Hand soldering 1-1) Temperature of soldering iron tip: 350 +/- 5 deg-C 1-2) Soldering time: 3 +/-0 sec 1-3) The soldering iron should be applied to the terminals. 1-4) Excessive load should not be applied. 1-5) Power of the soldering iron should not exceed 15 W. Measurements shall be made after reflow soldering under the following conditions. 1) Heating method: Far-infrared radiation heating 2) Temperature profile: As shown in below. 3) Allowable soldering process: 2 times Max.  <p style="text-align: center;">Fig. 7: Reflow soldering profile</p>	There shall be no abnormality such as marked looseness, drop-off, and assured 4. Electrical Characteristics. Operating force: Item 5.1.

5.9. Precautions for soldering

- 1) This product is designed for reflow soldering. Please do not solder manually.
- 2) Do not wash the product with solvent or the like.
- 3) The soldering conditions will be different depending on reflow soldering machines. Conditions of soldering shall be confirmed under actual production conditions.
- 4) Reflow soldering shall be performed in shorter time and at lower temperature. Otherwise click ratio may be decreased.
- 5) Please set the proper volume of solder in order to prevent soldering flux ingress and float of the products.
- 6) Please do not apply soldering flux to the terminals and mounting surface of PWB/FPC.
- 7) Note that if the load is applied to the terminals during soldering it might cause deformation and defects in electrical performance.



File number

1797

6. Durability

Item	Test conditions	Criteria
6.1. Operating life	<p>Measurements shall be made after testing under the following conditions.</p> <ol style="list-style-type: none"> 1) Electrical load: Rated load or no load. 2) Rate of operation: 2 cycles/sec. 3) Depression: The maximum value of specified operating force. 4) Cycles of operation: Specified on the product specification. 5) Pusher : Refer to Fig-2 	<p>Contact resistance: 1 ohm Max.</p> <p>Insulation resistance: 10 M-ohm Min.</p> <p>Withstanding voltage: Item 4.3.</p> <p>Bounce (ON/OFF): 20 msec Max.</p> <p>Operating force: Within +/-30% of specified initial value.</p> <p>Travel: Item 5.3.</p>

7. Environmental

Item	Test conditions	Criteria
7.1. Humidity resistance	<p>Following the test set forth below the sample shall be left in normal temperature and humidity conditions for 1 hr before measurements are made.</p> <p>Water drops shall be removed.</p> <ol style="list-style-type: none"> 1) Temperature: 60+/-3 deg-C, Humidity: 90 to 96% RH 2) Duration: 96+/-5 hr 	<p>Contact resistance: 1 ohm Max.</p> <p>Insulation resistance: 10 M-ohm Min.</p>
7.2. Heat resistance	<p>Following the test set forth below the sample shall be left in normal temperature and humidity conditions for 1 hr before measurements are made.</p> <ol style="list-style-type: none"> 1) Temperature: 85+/-3 deg-C 2) Duration: 96+/-5 hr 	<p>Withstanding voltage: Item 4.3.</p> <p>Bounce (ON/OFF): 20 msec Max.</p>
7.3. Cold resistance	<p>Following the test set forth below the sample shall be left in normal temperature and humidity conditions for 1 hr before measurements are made.</p> <p>Water drops shall be removed.</p> <ol style="list-style-type: none"> 1) Temperature: -40+/-3 deg-C 2) Duration: 96+/-5 hr 	<p>Operating force: Within +/-30% of specified initial value.</p> <p>Travel: Item 5.3.</p>

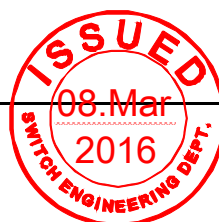

File number

1797

7. Environmental

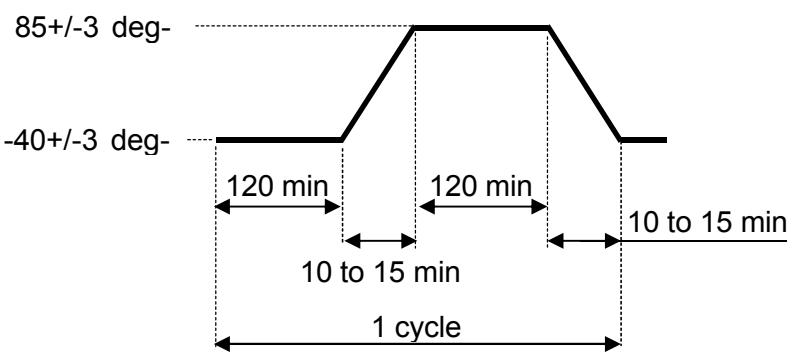
Item	Test conditions	Criteria
7.4. Temperature cycling	<p>Following continuous 5 cycles of the temperature cycling test set forth below, the sample shall be left in normal temperature and humidity conditions for 1hr before measurements are made.</p>  <p>Fig. 8: Temperature cycling test conditions</p>	<p>Contact resistance: 1 ohm Max.</p> <p>Insulation resistance: 10 M-ohm Min.</p> <p>Withstanding voltage: Item 4.3.</p> <p>Bounce (ON/OFF): 20 msec Max.</p> <p>Operating force: Within +/-30% of specified initial value.</p> <p>Travel: Item 5.3.</p>

8. Use Condition

8.1. Operating temperature range: Refer to the item 1.2.

(Temperature range which the product is ON and OFF electrically.)

There shall be no freezing and condensation.

8.2. Using environment

- 1) Do not expose the products to corrosive gas such as sulfur gas and salty wind.
- 2) Visible dust must be cleared.
- 3) Please do not apply excessive load to the products to avoid deformation and deterioration.

9. Storage Condition

9.1. Storage temperature range: Refer to the item 1.3. There shall be no freezing and condensation.

9.2. Environment

- 1) Do not expose the products to corrosive gas such as sulfur gas, and salty wind.
- 2) Visible dust must be cleared.
- 3) Please do not apply excessive load to the products to avoid deformation and deterioration.

9.3. Storage method

- 1) Products shall be packed in an airtight plastic bag and stored in cool place avoiding direct sunshine.
- 2) Do not stack too many switches for strafe. Shall be free from high temperature and high humidity.
- 3) Do not store the products in the state of applying load on it's operation area.
- 4) Products should be used within six months after the date of delivery.



File number

1797

10. Precautions in Use

- 10.1. Do not clean the products with a solvent or the like.
- 10.2. Do not use the products with beyond the rated current and voltage.
- 10.3. Do not apply excessive load to the terminals and the operating part.
- 10.4. Larger static load than specified and/or shock shall not be applied to the operating part.
- 10.5. After mounting the products on PWB/FPC, please do not stack too many PWB/FPC in order to avoid excessive load to the switch mounted area.
- 10.6. The dimensions of a pattern on PWB/FPC shall refer to the recommended dimensions in Product specifications.
- 10.7. If you use this product in one of the following environmental conditions, progress of sulfuration and oxidization on the contact part (silver) will be accelerated, which may cause contact failure.
Therefore, be careful about the operation environment.
 - 1) Around a sulfurate hot spring where sulfide gas is generated.
 - 2) In case this product is always used in a place where exhaust gas from automobiles exist.
- 10.8. Use of organic acid flux shall be avoided because it may cause corrosion of the switch. Please make sure the type of flux before you use it.
- 10.9. As this switch is designed for reflow soldering, if you place it at the edge of PWB for convenience, then flux may get into the sliding part of the switch during automatic dip soldering after being mounted, so do not apply auto dip after being mounted.
- 10.10. The operating part should be moved to the appointed position in order to ensure proper operation.
- 10.11. Do not push the cover film of products with something sharp.
- 10.12. Please design and assemble your unit not to apply over load to the switch.
- 10.13. Please let us know beforehand if you use other shape of pushing rod than the shape described in Fig. 2.
- 10.14. Unless provided for otherwise, the products have been designed and manufactured for application in equipment and devices which are sold to end users in the market, including audio-visual equipment, electrical home appliances, office machines, information and communication equipment, and amusement equipment.
The products are not intended for use in, and must not be used for, any application for nuclear equipment, driving equipment for aerospace or any other unauthorized use. With the exception of the abovementioned prohibited applications, please contact us (MITSUMI) and/or evaluate the total system regarding applicability for applications involving high levels of safety and liability such as medical equipment, burglar alarm equipment, disaster prevention equipment and undersea equipment. Please also incorporate fail-safe design, protection and redundant circuitry, malfunction protection, and/or fire protection into the complete system to ensure safety and reliability of the total system.
- 10.15. If you intend to use the products for automotive, please let us know beforehand.

11. Manufacturing Location

<Sales Section>

MITSUMI ELECTRIC CO.,LTD.

<Management Section>

MITSUMI ELECTRIC CO.,LTD., Kyushu Business Division

<Manufacturing Section>

QINGDAO MITSUMI ELECTRONICS CO.,LTD. (China:CQE)

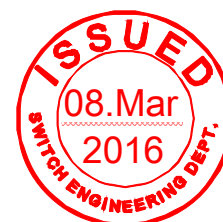

File number

1797

12. Packing Specification

12.1. Dimensions of carrier tape are as shown below.

12.2. Taping rule

- 1) Tape winding direction is in clockwise.
(When pulling the tape toward, feeding holes should be located on the right side.)
- 2) Feeding holes shall not be covered with the cover tape.
The cover tape shall not be run off the edge of the carrier tape.
- 3) 160 mm or more from the end of trailer tape part shall be empty.
- 4) The leader part shall be 400 mm or more and it should include 100 mm of empty part.
The leader part shall have 20 to 30 mm of un-sealed cover tape.
- 5) The top tape of the leader part shall be stuck on the side of the reel by 30 to 50 mm using adhesive tape.
- 6) Peeling strength of cover tape from carrier tape is 0.1 to 1.3 N at 165 to 180 deg.
- 7) Bar-code label and Mitsumi label shall be stuck on the side of the reel.
- 8) The products shall free drop from the reversed carrier tape without cover tape after pressing at 0.1 to 0.2 N force.
- 9) 10,000 switches shall be packed in a reel.

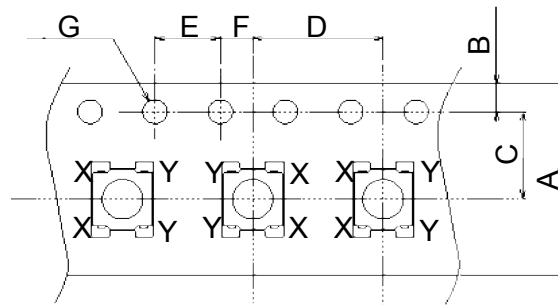

(note) In a reel, a terminal direction (direction of A and B in above figure) may turn 180 degrees. But it cannot turn 90 degrees.

[mm]						
A	B	C	D	E	F	G
12	1.75	5.5	8+/-0.1	4+/-0.1	2	1.5 dia +0.1/-0

Fig. 9 Carrier tape dimensions

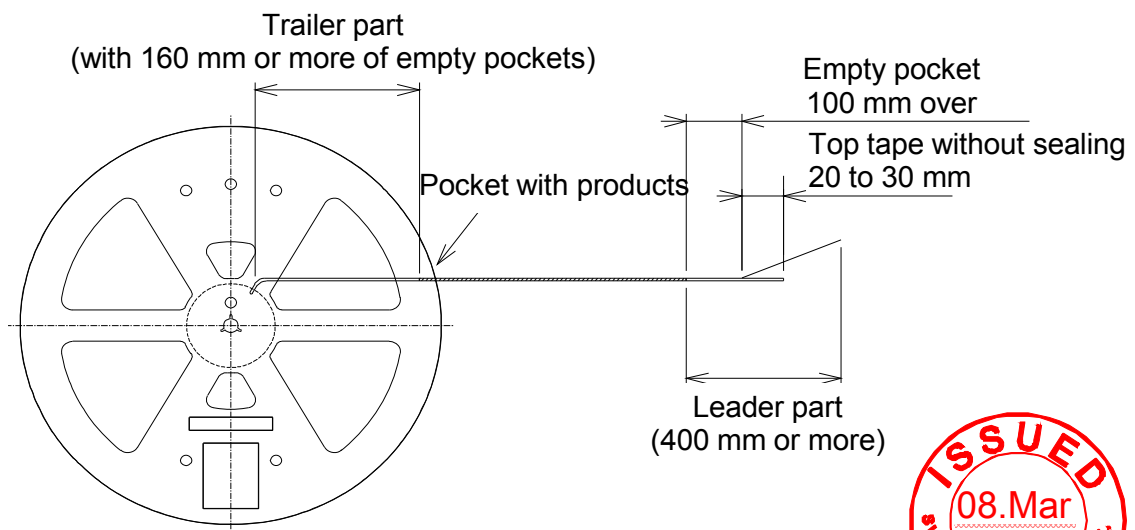

Fig. 10 Taping specification



File number

1797

13. Packing Specification

1) Inner packing specification

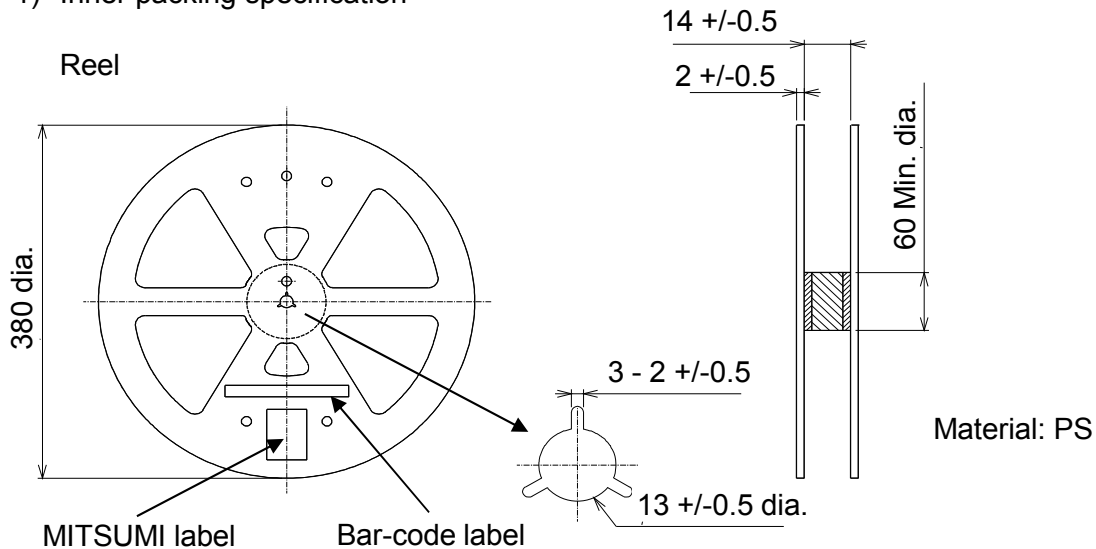

2) Outer box specification

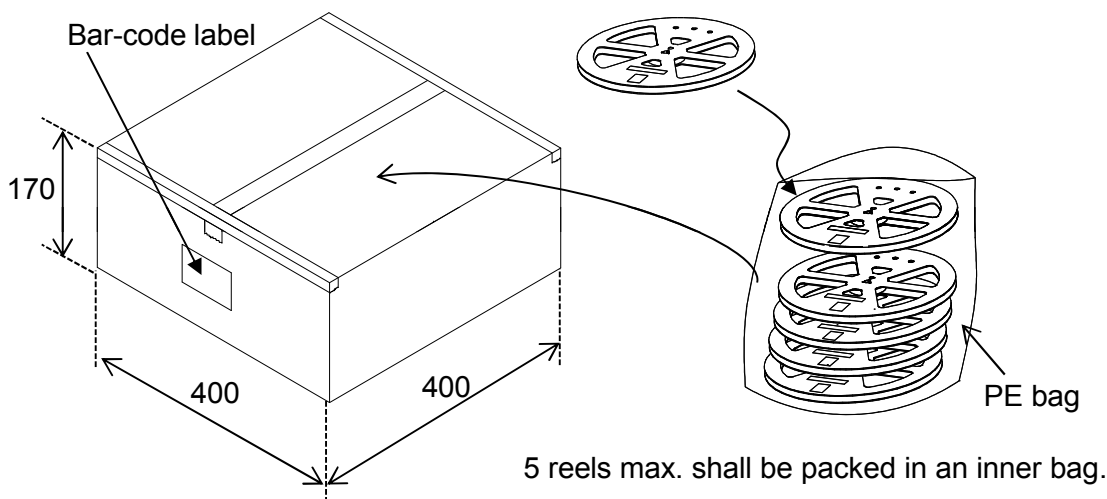

3) MITSUMI label specification

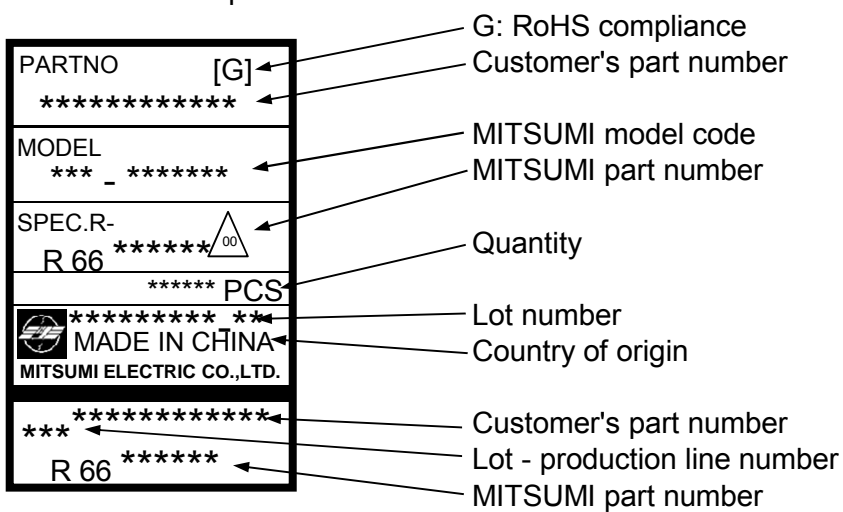

File number
1797

4) Bar Code Label

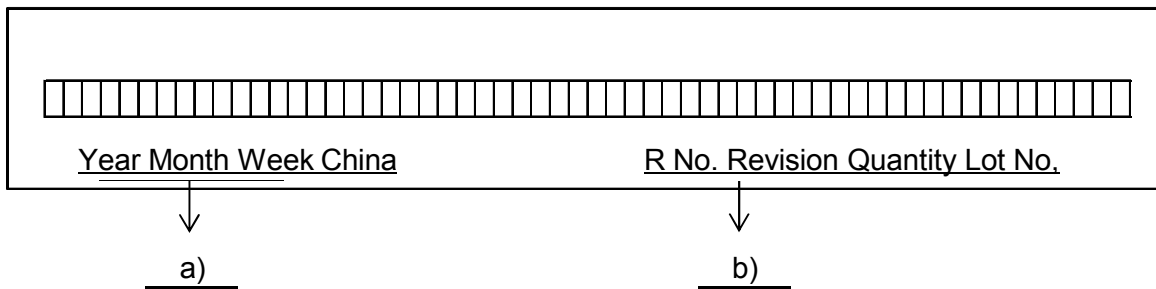

a) Example:

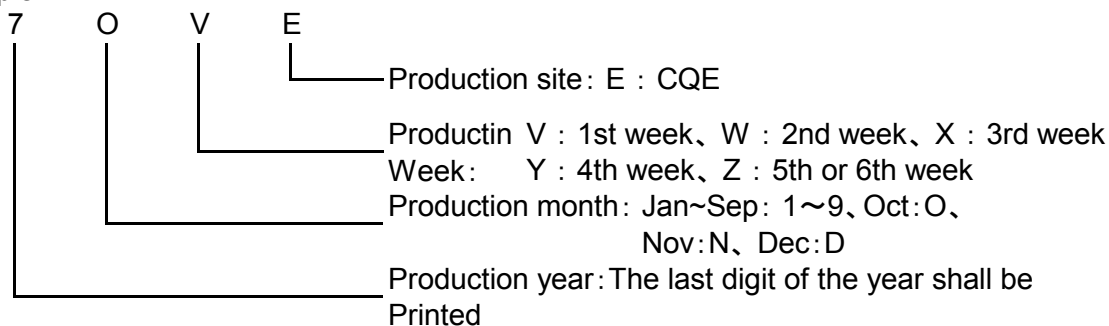

b) Example:

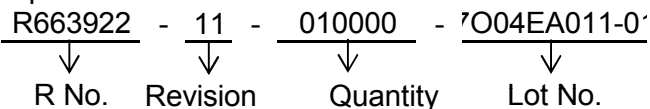

Lot No. Description

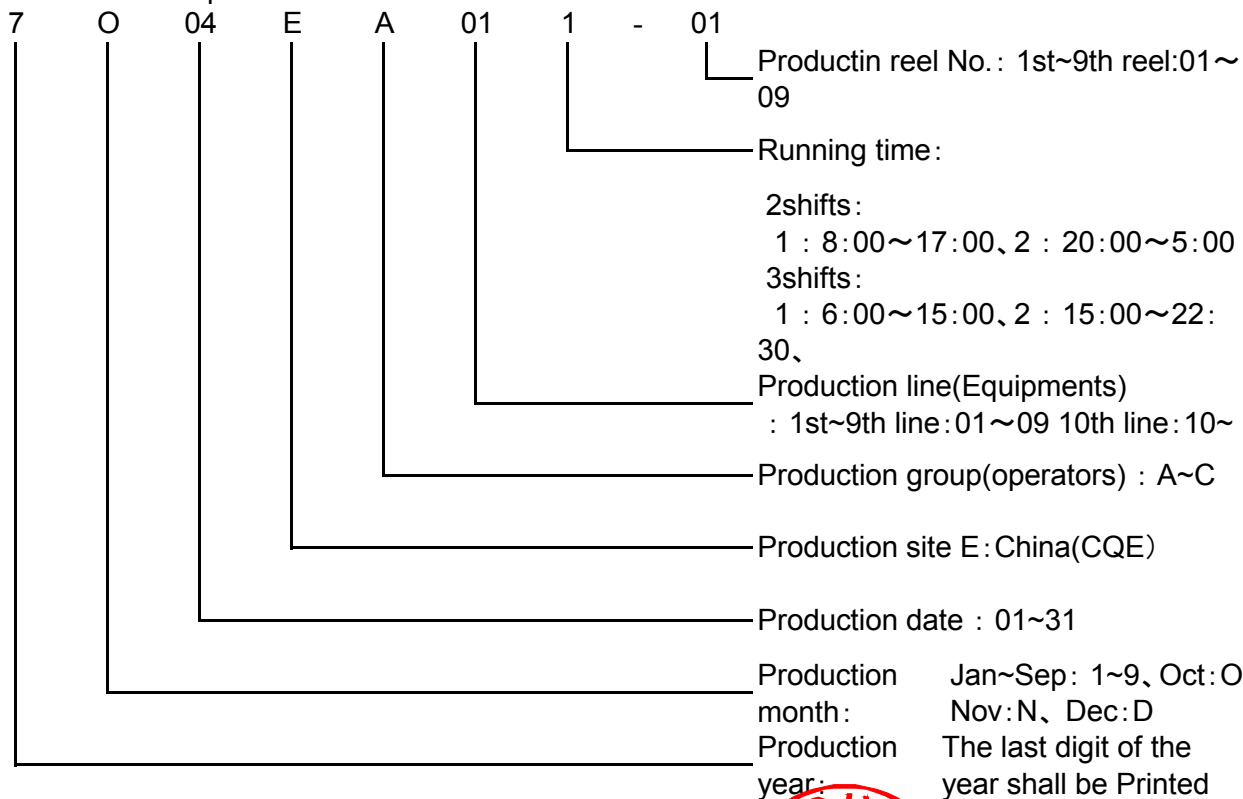

File number
1797