

MHE High Current Low DCR Power Inductors MHE0503 Series

FEATURES AND APPLICATIONS

Laird MHE series high current power inductors improve performance, reliability and power efficiency. A lower power loss benefits consumer electronics, Industrial and Telecom product design. Products feature extremely low DCR with greater efficiency and enable a larger current in a small size. Inductors are of magnetic shielding and molded construction and perform in operating temperatures ranging from -40°C to 125°C (including self-heating temperature rise)

FEATURES

- High saturation current realized by optimum coil design and high performance powder
- Low profile and very compact in size
- Very low DCR

APPLICATIONS

- Industrial DC to DC power lines
- Telecom and Datacom DC to DC power lines
- DC to DC converter with low power loss, low voltage and high output current such as CPU ,VRM, etc

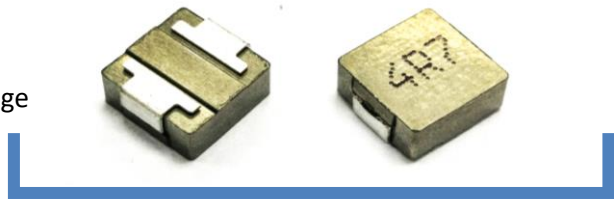

PART NUMBER EXPLANATION

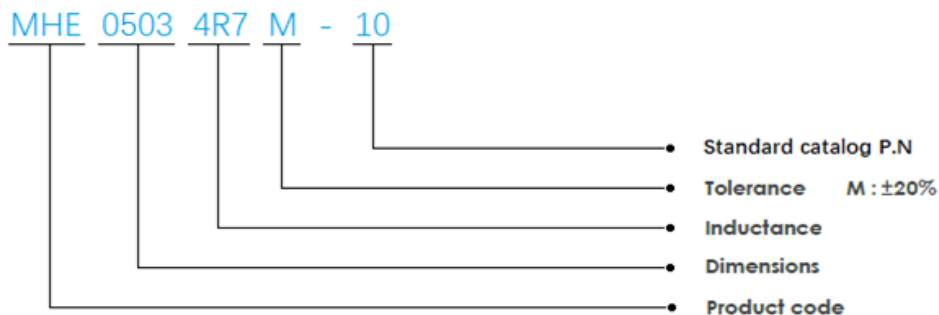

ELECTRICAL SPECIFICATIONS

- Inductance tested at 1MHz, 1.0V
- Heat Rated Current (I_{rms}) is defined based on temperature rise approximate 40°C without core loss (ambient temperature 25±5°C)
- Saturation Current (I_{sat}) is the DC current at which the inductance drops off approximately 30% from its value without current. (ambient temperature 25±5°C)
- Operating temperature range: -40°C~+125°C (including self-heating temperature rise)
- Storage temperature range (packaging conditions): -10°C~+40°C and RH 60%(MAX.)

Note: Heat Rated Current (I_{rms}) is tested on a typical PCB and apply a constant current in still air. The temperature rise is dependent on the application system condition including PCB PAD pattern, trace width and thickness and adjacent components etc. It's suggested to verify the temperature rise of the component under the real operation application conditions.

1.MHE0503 SERIES DIMENSIONS

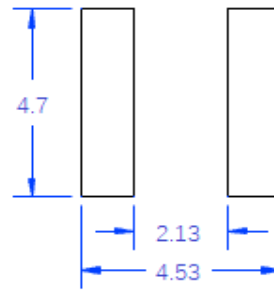
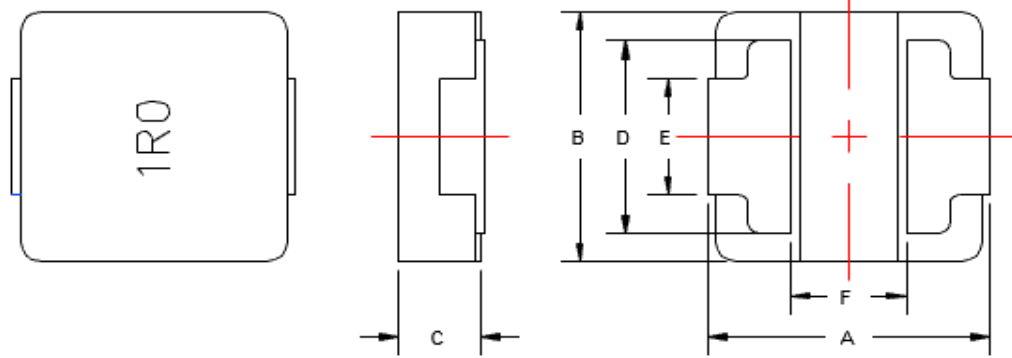

Recommended layout

MHE0503 Series

A	B	C	D	E	F
5.7±0.3	5.4±0.3	3.0 Max	4.2±0.3	2.0±0.3	2.4±0.3

2.SPECIFICATION

Part No.	Inductance (μ H) 1MHz/1.0V	DC Resistance (mohm) Typ	DC Resistance (mohm) Max	Isat (A) Typ/Max		I _{rms} (A) Typ/Max		SRF (MHz) Typ
MHE0503R33M-10	0.33 \pm 20%	3.4	3.6	26.0	23.4	19.2	17.3	102
MHE0503R68M-10	0.68 \pm 20%	5.8	6.5	22.0	19.8	14.5	13.8	70
MHE05031R0M-10	1.0 \pm 20%	7.2	8.5	17.0	14.0	11.1	10.5	55
MHE05032R2M-10	2.2 \pm 20%	13.2	14.5	11.0	9.2	9.7	9.2	34
MHE05033R3M-10	3.3 \pm 20%	20.0	23.0	10.5	8.7	8.1	7.7	28
MHE05034R7M-10	4.7 \pm 20%	29.5	35.5	8.5	6.8	5.9	5.6	21

3.EQUIVALENT CIRCUIT

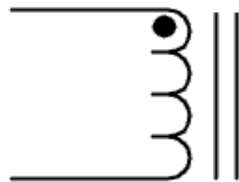

4.MATERIAL LIST

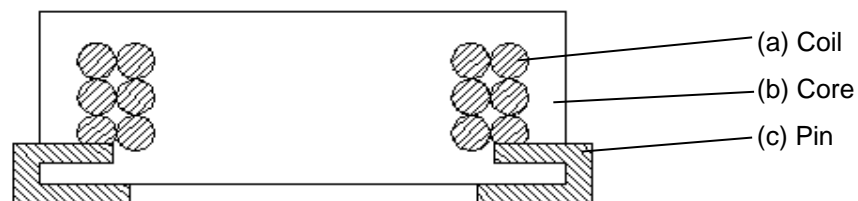

5. CHARACTERISTICS CURVES

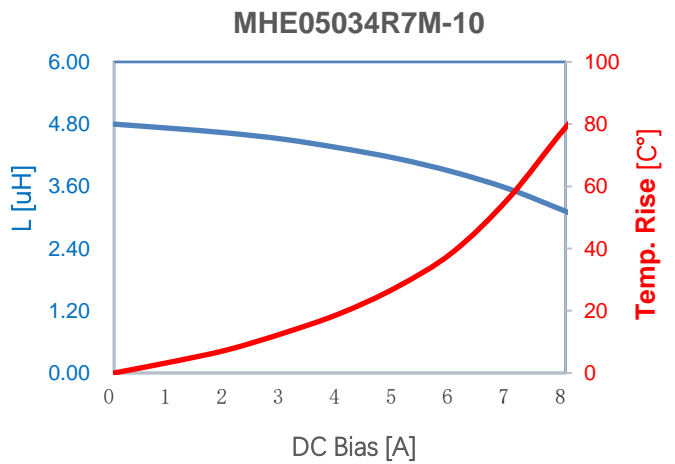
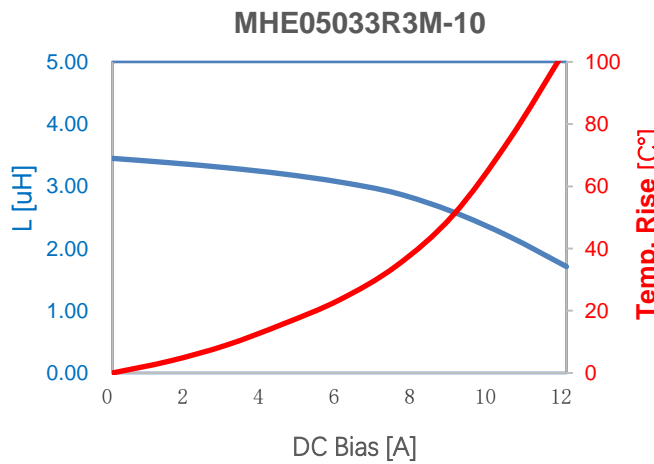
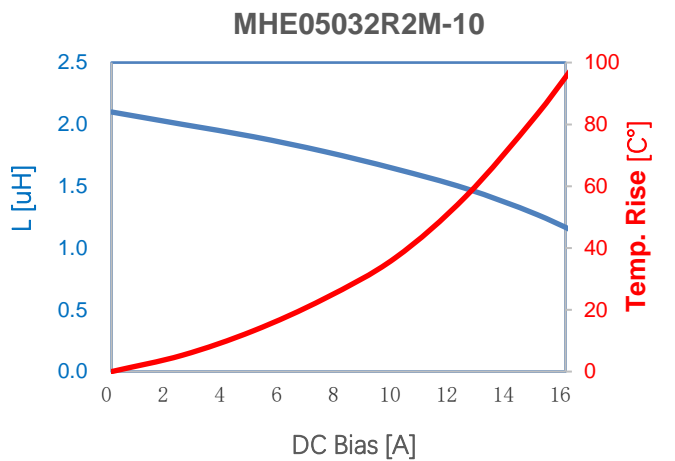
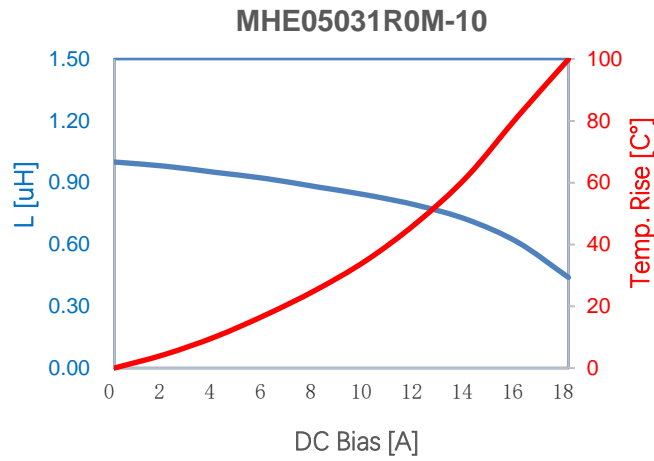
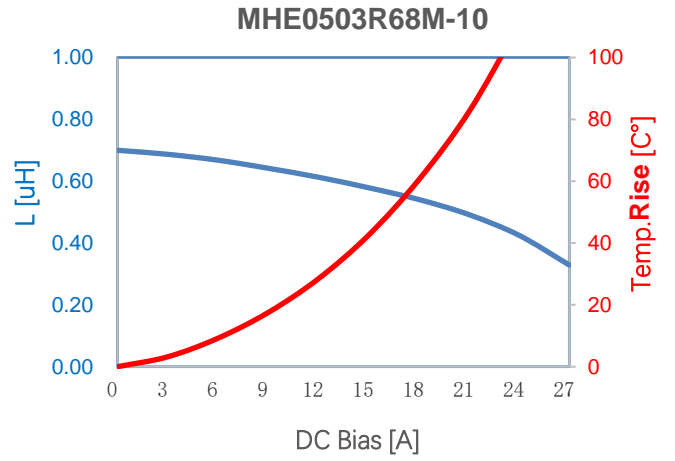
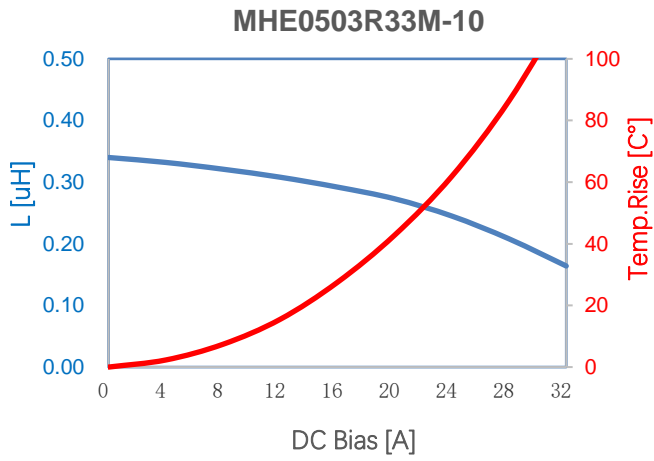

6. SOLDERING

Mildly activated rosin fluxes are preferred.

Recommended temperature profiles for re - flow soldering in Figure 1 .

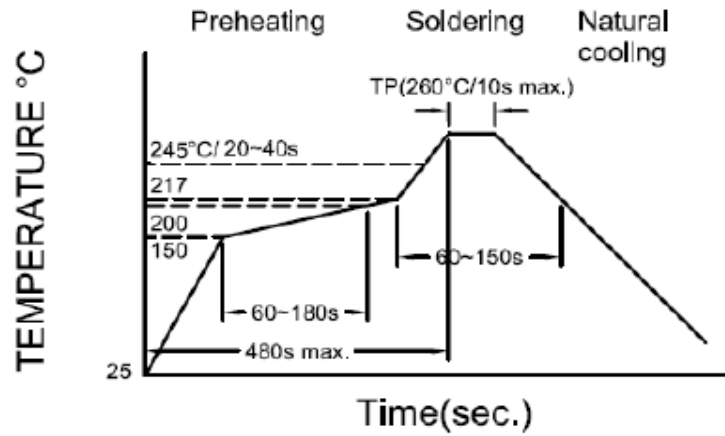
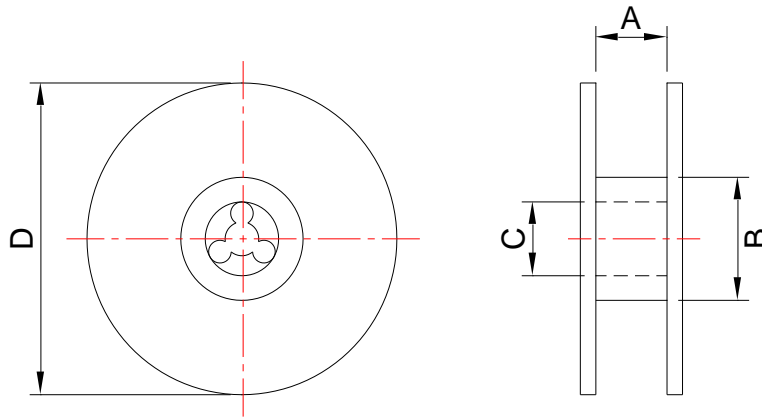

Figure 1. : Re-flow Soldering time
3 times Max.

7. PACKAGING

7-1 Reel Dimension



Type	A(mm)	B(mm)	C(mm)	D(mm)
13'x12	12.4+2/-0	100 ± 2	13+0.5/-0.2	330

7-2 Tape Dimension

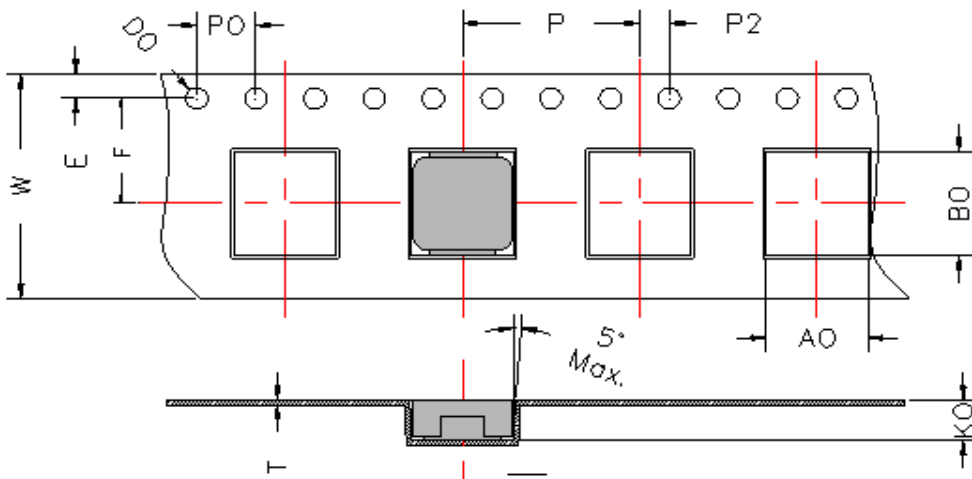

W	E	F	P	A0	B0	P2	P0	K0	t	D0
12.0±0.3	1.75±0.1	5.50±0.1	8.00±0.1	5.5 Ref	6.0 Ref	2.0±0.1	4.0±0.1	3.25±0.1	0.35±0.05	1.5Ref.

Size	Reel	Inner Box	Outer Box
MHE0503	2000	4000	8000

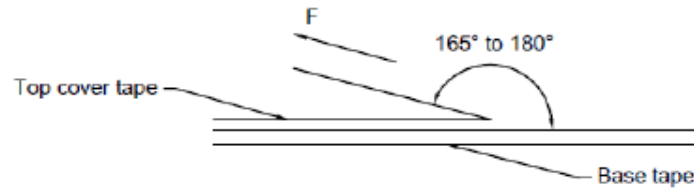
7-3 Tearing Off Force

The force for tearing off cover tape is 10~100 grame in the arrow direction under the following conditions .

Room Temp (°C)	Room Humidity(%)	Room atm (hPa)	Tearing Speed mm/min
5~35	45~85	860~1060	300

8. Application Notice:**1.Storage Conditions:**

To maintain the solderability of terminal electrodes:

- a) Recommended products should be used within 12 months from the time of delivery .
- b) The packaging material should be kept where no chlorine or sulfur exists in the air .

2. Transportation:

- a) Products should be -handled with care to avoid damage or contamination from perspiration and skin oils .
- b) Vacuum pick up is strongly recommended for individual components .
- c) Bulk handling should ensure that abrasion and mechanical shock are minimized .