

## LTC7820EUF High Efficiency, Charge Pump DC/DC Converter

### DESCRIPTION

Demonstration circuit 2543B is a high efficiency, high density, open loop charge pump (inductorless) DC/DC converter. This demo board is a voltage divider which achieves a 2:1 step-down ratio from an input voltage from 36V to 60V. The output voltage is a fixed ratio of half of the input voltage ( $V_{IN}/2$ ) and can supply a 10A load current. This demo board has the option to deliver a 20A maximum load with the addition of 15 chip capacitors. See Figure 8 and Figure 10 for the details.

The DC2543B provides a very high efficiency solution of 98.7% when converting  $48V_{IN}$  to  $24V_{OUT}$  at 10A as shown in Figure 3. When configured for a 20A output, an efficiency of up to 98.4% is achievable for a  $48V_{IN}$  to  $24V_{OUT}$  at 20A as shown in Figure 8.

The demo board features the [LTC<sup>®</sup>7820](#), a fixed ratio high voltage high power switched capacitor/charge pump controller in a 4mm × 5mm QFN package. Please see LTC7820 data sheet for more detailed information.

The DC2543B needs to be powered on with no load current or a very small load current (less than 50mA) with the default setup. Large load current can be applied after  $V_O$  is established. The board offers a disconnect FET option which is controlled by the LTC7820 FAULT pin to disconnect the load during startup as shown in the schematic. Please refer to “Voltage Divider Prebalance Before Switching” section in the LTC7820 data sheet for more details regarding the startup of the voltage divider. The board also features some protection functions such as overcurrent and thermal shutdown to make it a reliable solution.

[Design files for this circuit board are available.](#)

All registered trademarks and trademarks are the property of their respective owners.

### PERFORMANCE SUMMARY Specifications are at $T_A = 25^\circ\text{C}$

PARAMETER	CONDITION	VALUE
Input Voltage Range		36V to 60V
Output Voltage, $V_{OUT}$	$V_{IN} = 36$ to $60\text{V}$ , $I_{OUT} = 0\text{A}$ to $10\text{A}$	$V_{IN}/2$
Maximum Output Current, $I_{OUT}$	$V_{IN} = 36$ to $60\text{V}$ , $V_{OUT} = V_{IN}/2$	10A
Typical Efficiency	$V_{IN} = 48\text{V}$ , $V_{OUT} = 24\text{V}$ , $I_{OUT} = 10\text{A}$	98.7%
Peak Efficiency	$V_{IN} = 48\text{V}$ , $V_{OUT} = 24\text{V}$	99%
Switching Frequency		200kHz

**NOTE:** DC2543B demo board includes a Schottky diode added across the output. This manual describes the demo board entitled “Demo Circuit 2543B.” The DC2543B replaces the DC2543A.

## QUICK START PROCEDURE

Demonstration circuit 2543B is easy to set up to evaluate the performance of the LTC7820. Refer to Figure 1 for the proper measurement equipment setup and follow the procedure below.

1. With power off, connect the input power supply to  $V_{IN}$  (36V to 60V) and GND (input return).
2. Connect the output loads between  $V_{OUT}$  and GND (Initial load: no load). Refer to Figure 1.
3. Connect the DVMs to the input and output.
4. Check the default jumper/switch position: SW1 (RUN): OFF; JP2 (BIAS): ON.
5. Turn on the input power supply and adjust voltage to 48V.

NOTE: Make sure that the input voltage does not exceed 60V.

6. Turn on the switches: SW1: ON.
7. Check for the proper output voltages from  $V_{O\_SNS^+}$  to  $V_{O\_SNS^-}$ .
8. Once the proper output voltage is established, adjust the loads within the operating range and measure the efficiency, output ripple voltage and other parameters.
9. After completing all tests, adjust the load to 0A, power off the input power supply.

### Notes:

1. When measuring the output or input voltage ripple, do not use the long ground lead on the oscilloscope probe. See Figure 3 for the proper scope probe technique. Short, stiff leads need to be soldered to the (+) and (-) terminals of an output capacitor. The probe's ground ring needs to touch the (-) lead and the probe tip needs to touch the (+) lead.
2. When doing the load step test with the on-board dynamic load circuit, please make sure the load step-up pulse duty cycle does not exceed 2% and the pulse duration is less than 500 $\mu$ s so that the temperature of the MOSFETs Q9, Q23 in the dynamic load circuit stay in the safe region. Instead of using the on-board dynamic load circuit, an electric load can also be used for the load step test, which does not have the 2% maximum duty cycle limit for the load step.
3. It is recommended to set the electronic load in CR (constant resistance) mode for evaluation of the DC2543B board. Some electronic loads draw negative current in CC (constant current) mode when evaluating the output overcurrent protection feature of DC2543B, which can violate the absolute maximum voltage rating  $-0.3V$  for  $V_{LOW}$  pin.

## QUICK START PROCEDURE

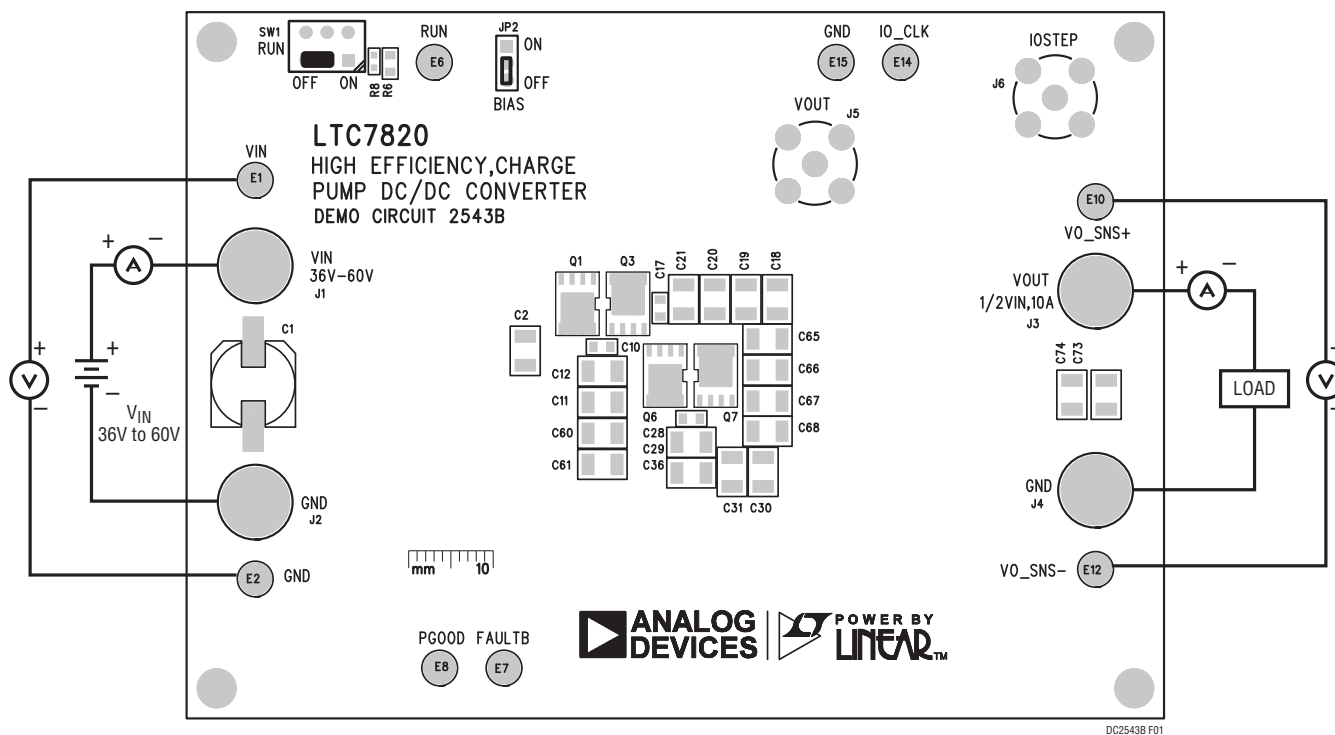

Figure 1. Proper Measurement Equipment Setup

**Note:** It is recommended to set the electronic load in CR (constant resistance) mode for evaluation of the DC2543B board. Some electronic loads draw negative current in CC (constant current) mode when evaluating the output overcurrent protection feature of DC2543B, which can violate the absolute maximum voltage rating  $-0.3V$  for  $V_{LOW}$  pin.

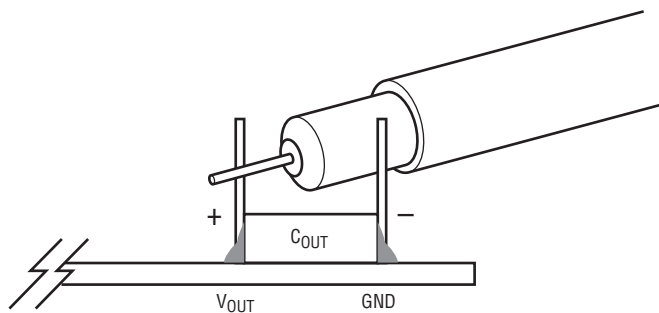

Figure 2. Measuring Output Voltage Ripple

## QUICK START PROCEDURE

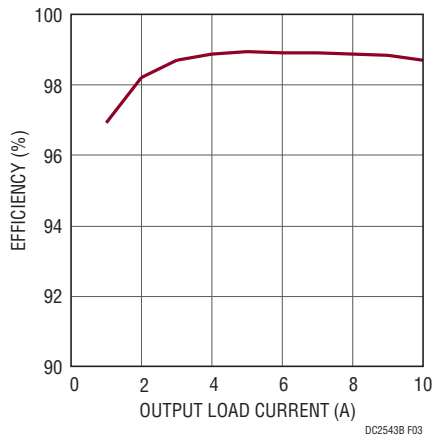

Figure 3. Efficiency vs Load Current at  $V_{IN} = 48V$ ,  $V_{OUT} = 24V$ ,  $f_{SW} = 200kHz$

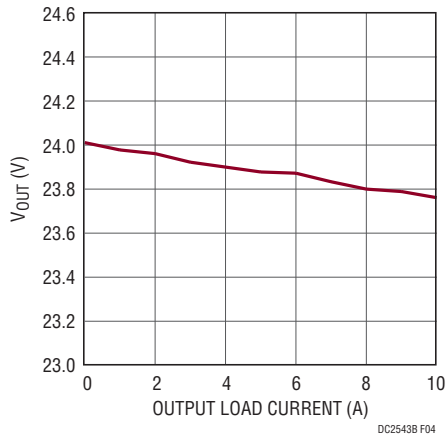

Figure 4. Load Regulation for 10A Design at  $V_{IN} = 48V$ ,  $V_{OUT} = 24V$ ,  $f_{SW} = 200kHz$

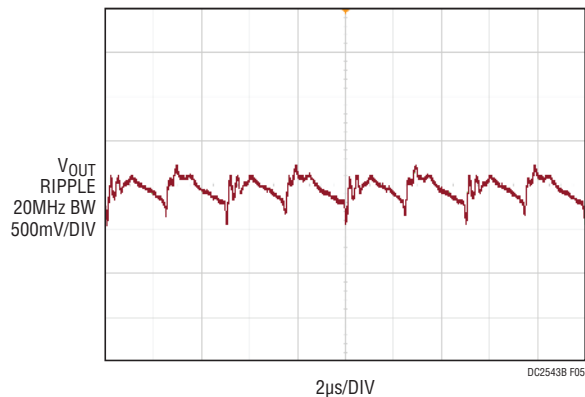

Figure 5. Output Voltage Ripple at  $V_{IN} = 48V$ ,  $V_{OUT} = 24V$ ,  $I_{OUT} = 10A$ ,  $f_{SW} = 200kHz$

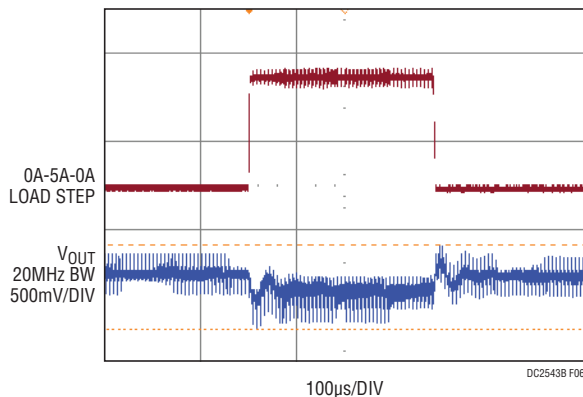

Figure 6. Load Step at  $V_{IN} = 48V$ ,  $V_{OUT} = 24V$

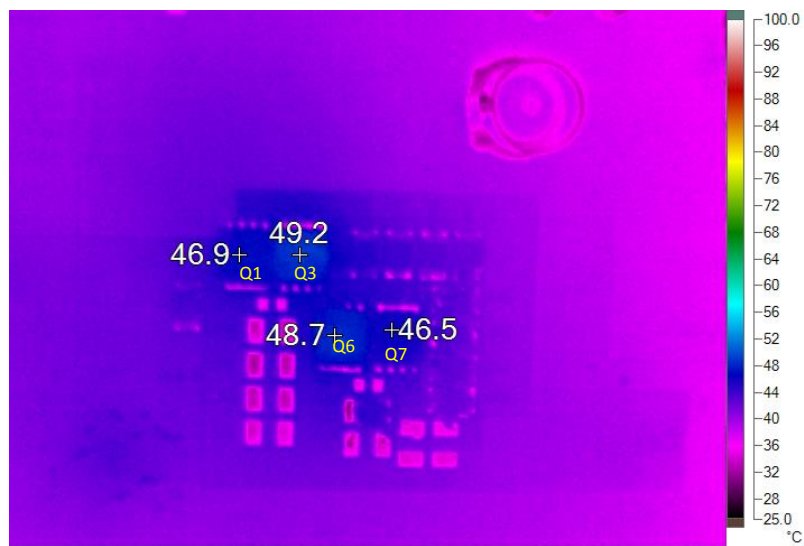
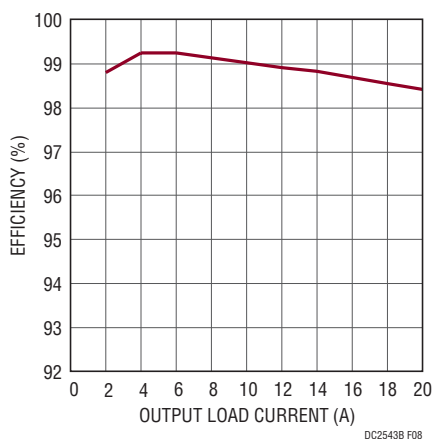
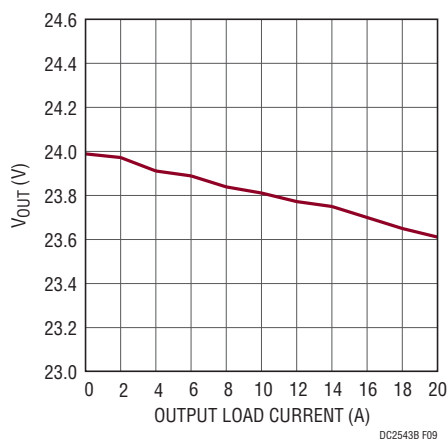

Figure 7. Thermal performance  $V_{IN} = 48V$ ,  $V_{OUT} = 24V$ ,  $I_{OUT} = 10A$ ,  $T_A = 23^\circ C$ , No Airflow

**QUICK START PROCEDURE**



**Figure 8. Efficiency vs Load Current at  $V_{IN} = 48V$ ,  $V_{OUT} = 24V$ ,  $f_{SW} = 200kHz$  \***



**Figure 9. Load Regulation for 20A Design at  $V_{IN} = 48V$ ,  $V_{OUT} = 24V$ ,  $f_{SW} = 200kHz$  \***

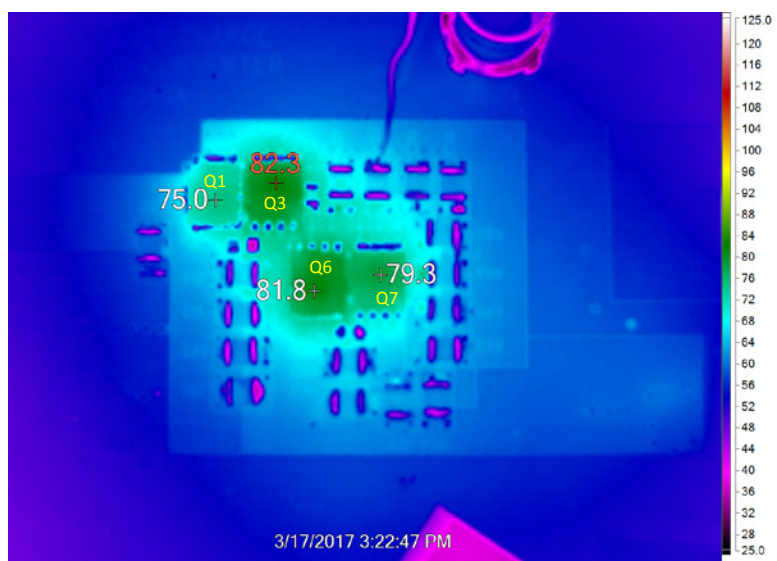

**Figure 10. Thermal performance at  $V_{IN} = 48V$ ,  $V_{OUT} = 24V$ ,  $I_{OUT} = 20A$ ,  $T_A = 23^\circ C$ , No Airflow \***

\* **Note:** Additional C11, C12, C60, C61, C22-C25, C69-C72, C30, C31, and C36 (10 $\mu$ F/50V, MURATA GRM32ER71H106KA12L) are populated; RS1 is changed to 2.5m $\Omega$  (WSL20102L500FEB18) for this test.

# DEMO MANUAL DC2543B

## PARTS LIST

ITEM	QTY	REFERENCE	PART DESCRIPTION	MANUFACTURER/PART NUMBER
<b>Required Circuit Components</b>				
1	1	C1	CAP, 33 $\mu$ F 20% 80V ELEC	PANASONIC EEHZA1K330P
2	8	C2, C3, C47, C49, C56, C57, C58, C59	CAP, 1210 2.2 $\mu$ F 10% 100V X7R	MURATA GRM32DR72A225KA12
3	4	C4, C5, C15, C126	CAP, 0603 0.1 $\mu$ F 10% 100V X7R	MURATA GRM188R72A104KA35D
4	2	C6, C7	CAP, 0805 4.7 $\mu$ F 10% 16V X7R	MURATA GRM21BR71C475KA73K
5	1	C8	CAP, 0603 0.22 $\mu$ F 10% 25V X7R	MURATA GRM188R71E224KA88D
6	2	C9, C26	CAP, 0603 0.47 $\mu$ F 10% 25V X7R	MURATA GRM188R71E474KA12D
7	2	C17, C28	CAP, 0805 2.2 $\mu$ F 10% 50V X7R	TDK C2012X7R1H225K125AC
8	11	C18, C19, C20, C21, C29, C66, C67	CAP, 1210 10 $\mu$ F 10% 50V X7R	MURATA GRM32ER71H106KA12L
9		C68, C73, C74, C65		
10	2	C27, C50	CAP, 0603 1 $\mu$ F 10% 50V X5R	MURATA GRM188R61H105K
11	2	C52, C53	CAP, 1210 22 $\mu$ F 10% 25V X5R	AVX 12103D226KAT2A
12	1	C54	CAP, 0603 47nF 10% 25V X7R	AVX 06033C473KAT2A
13	1	C55	CAP, 0603 470pF 10% 50V X7R	MURATA GRM188R71H471KA01D
14	3	D1, D2, D3	DIODE, SCHOTTKY	CENTRAL SEMI. CMDSH-4E TR
15	1	D6*	DIODE, SCHOTTKY	ON SEMI, NRVTSAF5100E
16	2	D9, D10	DIODE, ZENER	CENTRAL SEMI. CMHZ5236B TR
17	1	L2	IND, 68 $\mu$ H	COILCRAFT, LPS6225-683MRB
18	1	Q1	XSTR, N-CHANNEL MOSFET	INFINEON BSC027N06LS5
19	3	Q3, Q6, Q7	XSTR, N-CHANNEL MOSFET	INFINEON BSC032N04LS
20	4	Q9, Q10, Q11, Q23	XSTR, N-CH 40V 14A TO-252	VISHAY SUD50N04-8M8P-4GE3
21	1	Q22	TRANSISTOR., SOT-23	FAIRCHILD., BSS123L
22	1	RS1	RES., CHIP, 0.005, 1%, 2010	VISHAY, WSL20105L000FEA
23	1	RS2	RES, 2010 0 $\Omega$ JUMPER	VISHAY WSL201000000ZEA9
24	2	R1, R7	RES, 0603 1k $\Omega$ 1%	VISHAY CRCW06031K00FKEA
25	1	R2	RES, 0603 2.2 $\Omega$ 5%	YAGEO RC0603JR-072R2L
26	4	R5, R10, R24, R32	RES, 0603 0 $\Omega$ JUMPER	VISHAY CRCW06030000Z0EA
27	4	R9, R13, R17, R28	RES, 0603 10k $\Omega$ 1%	NIC NRC06F1002TRF
28	1	R16	RES, 0603 60.4k $\Omega$ 1%	VISHAY CRCW060360K4FKEA
29	1	R18	RES, 0603 100k $\Omega$ 1%	VISHAY CRCW0603100KFKEA
30	1	R26	RES, 0603 154k $\Omega$ 1%	YAGEO RC0603FR-07154KL
31	1	R27	RES, 0603 20k $\Omega$ 5%	VISHAY CRCW060320K0JNEA
32	1	R29	RES, 0603 80.6k $\Omega$ 1%	YAGEO RC0603FR-0780K6L
33	1	R30	RES. 2010 1 $\Omega$ 1% 1W	IRC LRC-LR2010-01-1R00-F
34	1	R31	RES, 0603 100 $\Omega$ 5%	VISHAY CRCW0603100R0JNEA
35	1	U1	IC, LTC7820EUF, QFN 4mm $\times$ 5mm	ANALOG DEVICES, LTC7820EUF#PBF
36	1	U2	IC, LTC3630AEMSE	ANALOG DEVICES, LTC3630EMSE#PBF

## PARTS LIST

### Additional Demo Board Circuit Components

1	0	C10-C14, C16, C33, C34, C35, C36, C60-C64, C51, C77	CAPACITOR, OPT	
2	0	C30-C32, C22-C25, C69-C72, C127		
3	0	Q2, Q4, Q5, Q8 OPT	MOSFET, OPT	
4	0	R6, R19, R2, R36, R8, R11, R12, R20, R34, R35, R60	RESISTOR, OPT	

### Hardware: For Demo Board Only

1	9	E1, E2, E6-E8, E10, E12, E14, E15	TURRET	MILL-MAX 2501-2-00-80-00-00-07-0
2	1	JP2	HEADER, 3 PIN 2mm	WURTH ELEKTRONIK 62000311121
3	4	J1, J2, J3, J4	JACK, BANANA	KEYSTONE, 575-4
4	2	J5, J6	CONN, BNC, 5 PINS	CONNEX, 112404
5	1	SW1	SWITCH, SUBMINIATURE SLIDE	C&K COMPONENTS, JS202011CQN
6	1	XJP2	SHUNT 2mm	WURTH ELEKTRONIK 60800213421
7	4	STANDOFF	STANDOFF, SNAP ON	KEYSTONE 8833

**\*Note:** D6 is for negative voltage clamping on  $V_{OUT}$  of DC2543B board in output overcurrent test with electronic load. Some electronic loads draw negative current in CC mode when evaluating the output overcurrent protection feature of DC2543B, which can violate the absolute maximum voltage rating  $-0.3V$  for  $V_{LOW}$  pin without D6 populated.

# DEMO MANUAL DC2543B

## SCHEMATIC DIAGRAM

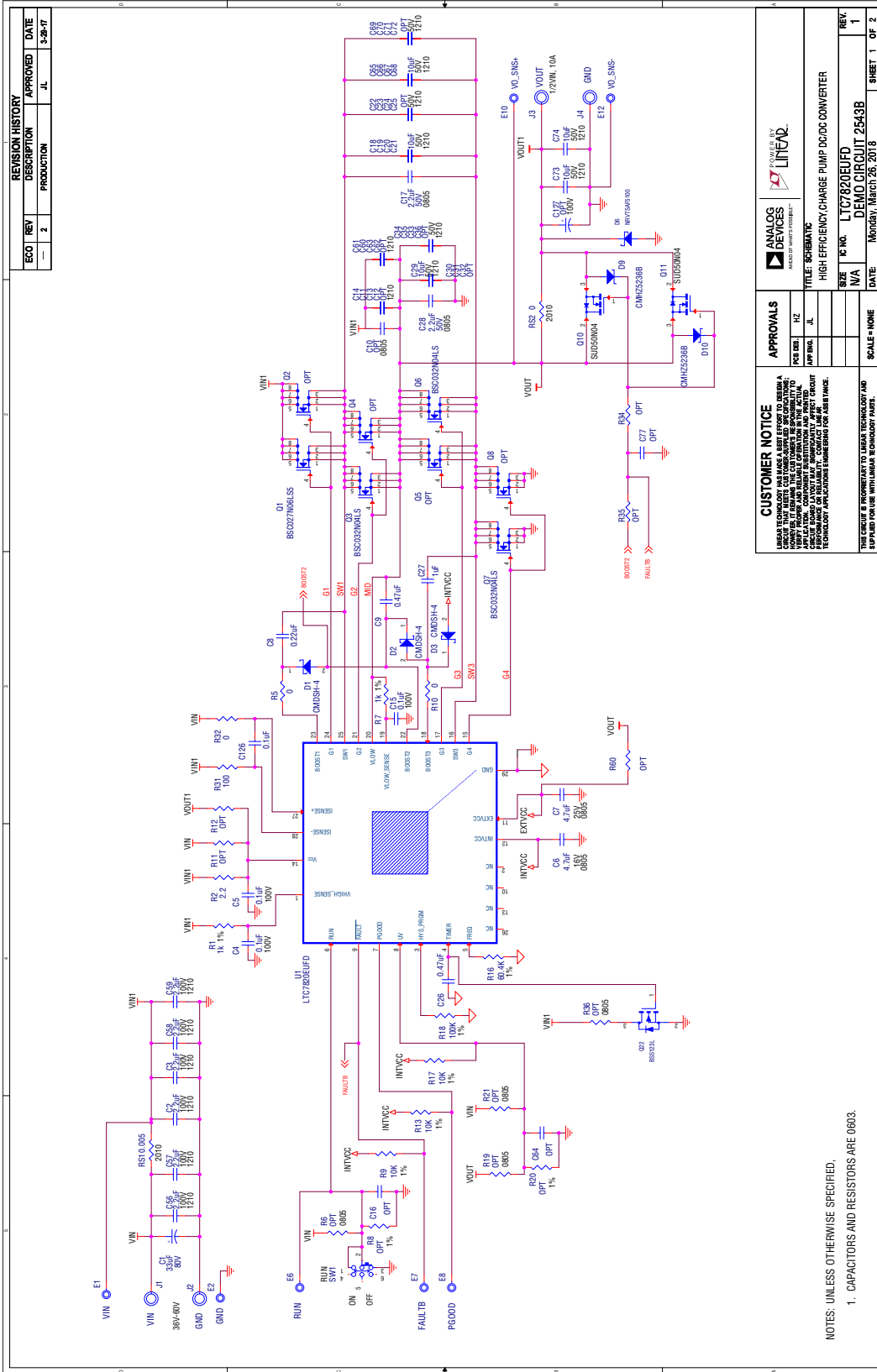

REVISION HISTORY			APPROVED	DATE
ECD	REV	DESCRIPTION	JL	3/26/17
—	2	PRODUCTION		

APPROVALS		ANALOG DEVICES		LTC7820ELFDC	
DESIGN	JL	DESIGN	JL	REV. NO.	1
APPVAL	JL	APPVAL	JL	DATE	MONDAY, MARCH 28, 2018
TITLE: SCHEMATIC				REV. NO.	1
HIGH EFFICIENCY CHARGE PUMP DCDC CONVERTER				DATE	MONDAY, MARCH 28, 2018
SCALE: NONE				SHEET 1	OF 2

**CUSTOMER NOTICE**  
 LINEAR TECHNOLOGY AND ITS AFFILIATES EXPRESSLY DISCLAIM ANY LIABILITY FOR DAMAGES OF ANY KIND, INCLUDING CONSEQUENTIAL DAMAGES, THAT MAY BE INCURRED AS A RESULT OF THE USE OF THIS DOCUMENT. THIS DOCUMENT IS PROVIDED AS-IS AND WITHOUT WARRANTY OF ANY KIND, INCLUDING MERCHANTABILITY AND FITNESS FOR A PARTICULAR PURPOSE. ANY WARRANTIES OR CONDITIONS OF ANY KIND, WHETHER EXPRESS OR IMPLIED, ARE HEREBY DISCLAIMED. CUSTOMER AGREES TO HOLD LINEAR TECHNOLOGY HARMLESS FROM AND AGAINST ALL SUCH DAMAGES AND LIABILITY. LINEAR TECHNOLOGY APPLICATION ENGINEERING FOR ASSISTANCE.

NOTES: UNLESS OTHERWISE SPECIFIED,  
 1. CAPACITORS AND RESISTORS ARE 0805.



**SCHEMATIC DIAGRAM**

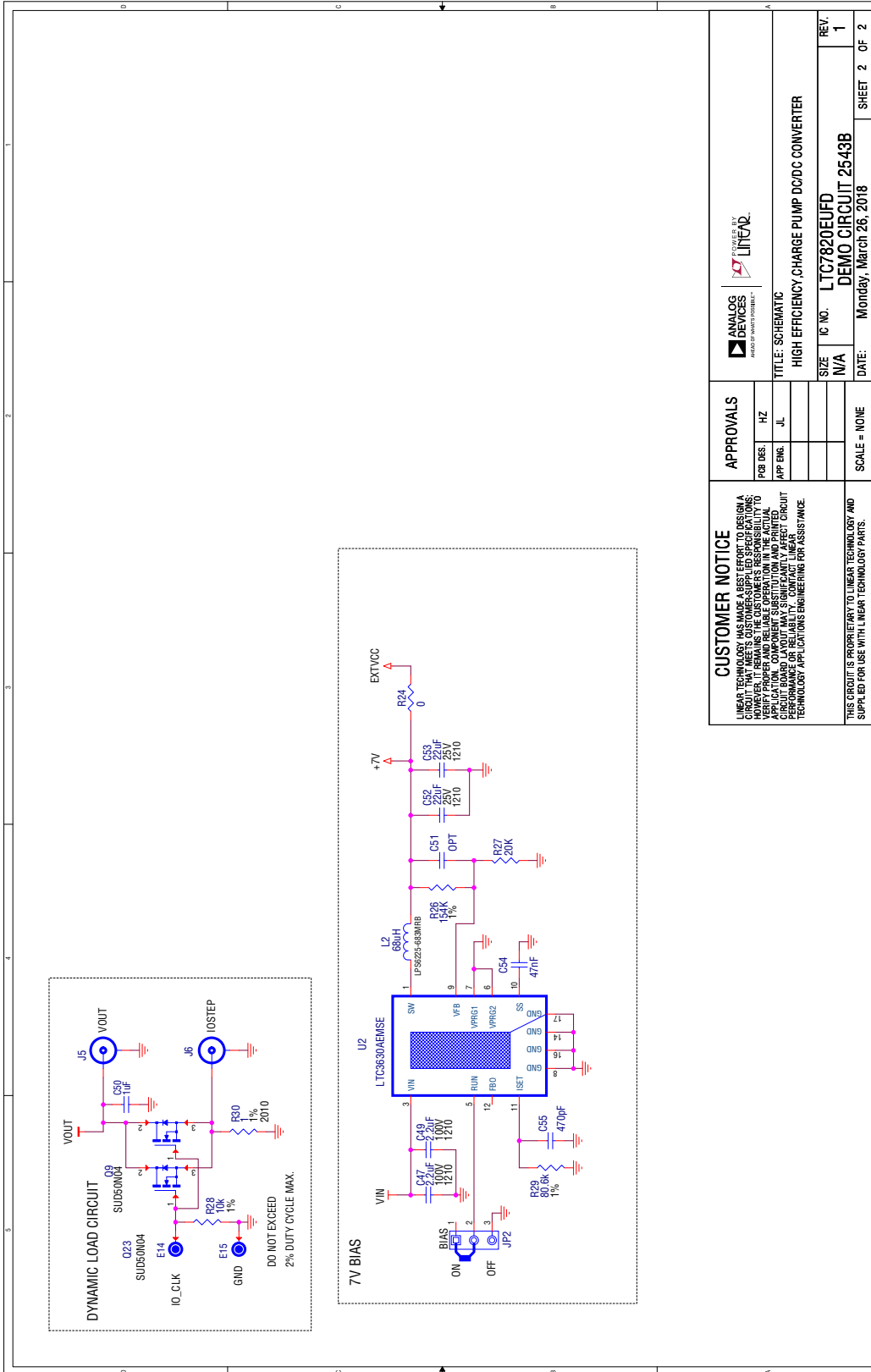

TITLE: SCHEMATIC HIGH EFFICIENCY CHARGE PUMP DC/DC CONVERTER			
IC NO.	LTC7820EUF	REV.	1
SIZE	N/A	DATE	Monday, March 26, 2018
APPROVALS		SHEET 2 OF 2	
PCB DES:	HZ		
APP ENG:	JL		
SCALE = NONE			

**CUSTOMER NOTICE**

LINEAR TECHNOLOGY HAS MADE A BEST EFFORT TO DESIGN A CIRCUIT THAT MEETS CUSTOMER-SUPPLIED SPECIFICATIONS. HOWEVER, LINEAR TECHNOLOGY DOES NOT ASSUME RESPONSIBILITY TO ANY EXTENT FOR THE USE OF THIS CIRCUIT IN ANY APPLICATION. COMPONENT SUBSTITUTION AND PRINTED CIRCUIT BOARD MANUFACTURING VARIATIONS MAY AFFECT PERFORMANCE OR RELIABILITY. CONTACT LINEAR TECHNOLOGY APPLICATIONS ENGINEERING FOR ASSISTANCE.

THIS CIRCUIT IS PROPRIETARY TO LINEAR TECHNOLOGY AND SUPPLIED FOR USE WITH LINEAR TECHNOLOGY PARTS.



## ESD Caution

**ESD (electrostatic discharge) sensitive device.** Charged devices and circuit boards can discharge without detection. Although this product features patented or proprietary protection circuitry, damage may occur on devices subjected to high energy ESD. Therefore, proper ESD precautions should be taken to avoid performance degradation or loss of functionality.

## Legal Terms and Conditions

By using the evaluation board discussed herein (together with any tools, components documentation or support materials, the "Evaluation Board"), you are agreeing to be bound by the terms and conditions set forth below ("Agreement") unless you have purchased the Evaluation Board, in which case the Analog Devices Standard Terms and Conditions of Sale shall govern. Do not use the Evaluation Board until you have read and agreed to the Agreement. Your use of the Evaluation Board shall signify your acceptance of the Agreement. This Agreement is made by and between you ("Customer") and Analog Devices, Inc. ("ADI"), with its principal place of business at One Technology Way, Norwood, MA 02062, USA. Subject to the terms and conditions of the Agreement, ADI hereby grants to Customer a free, limited, personal, temporary, non-exclusive, non-sublicensable, non-transferable license to use the Evaluation Board FOR EVALUATION PURPOSES ONLY. Customer understands and agrees that the Evaluation Board is provided for the sole and exclusive purpose referenced above, and agrees not to use the Evaluation Board for any other purpose. Furthermore, the license granted is expressly made subject to the following additional limitations: Customer shall not (i) rent, lease, display, sell, transfer, assign, sublicense, or distribute the Evaluation Board; and (ii) permit any Third Party to access the Evaluation Board. As used herein, the term "Third Party" includes any entity other than ADI, Customer, their employees, affiliates and in-house consultants. The Evaluation Board is NOT sold to Customer; all rights not expressly granted herein, including ownership of the Evaluation Board, are reserved by ADI. CONFIDENTIALITY. This Agreement and the Evaluation Board shall all be considered the confidential and proprietary information of ADI. Customer may not disclose or transfer any portion of the Evaluation Board to any other party for any reason. Upon discontinuation of use of the Evaluation Board or termination of this Agreement, Customer agrees to promptly return the Evaluation Board to ADI. ADDITIONAL RESTRICTIONS. Customer may not disassemble, decompile or reverse engineer chips on the Evaluation Board. Customer shall inform ADI of any occurred damages or any modifications or alterations it makes to the Evaluation Board, including but not limited to soldering or any other activity that affects the material content of the Evaluation Board. Modifications to the Evaluation Board must comply with applicable law, including but not limited to the RoHS Directive. TERMINATION. ADI may terminate this Agreement at any time upon giving written notice to Customer. Customer agrees to return to ADI the Evaluation Board at that time. LIMITATION OF LIABILITY. THE EVALUATION BOARD PROVIDED HEREUNDER IS PROVIDED "AS IS" AND ADI MAKES NO WARRANTIES OR REPRESENTATIONS OF ANY KIND WITH RESPECT TO IT. ADI SPECIFICALLY DISCLAIMS ANY REPRESENTATIONS, ENDORSEMENTS, GUARANTEES, OR WARRANTIES, EXPRESS OR IMPLIED, RELATED TO THE EVALUATION BOARD INCLUDING, BUT NOT LIMITED TO, THE IMPLIED WARRANTY OF MERCHANTABILITY, TITLE, FITNESS FOR A PARTICULAR PURPOSE OR NON-INFRINGEMENT OF INTELLECTUAL PROPERTY RIGHTS. IN NO EVENT WILL ADI AND ITS LICENSORS BE LIABLE FOR ANY INCIDENTAL, SPECIAL, INDIRECT, OR CONSEQUENTIAL DAMAGES RESULTING FROM CUSTOMER'S POSSESSION OR USE OF THE EVALUATION BOARD, INCLUDING BUT NOT LIMITED TO LOST PROFITS, DELAY COSTS, LABOR COSTS OR LOSS OF GOODWILL. ADI'S TOTAL LIABILITY FROM ANY AND ALL CAUSES SHALL BE LIMITED TO THE AMOUNT OF ONE HUNDRED US DOLLARS (\$100.00). EXPORT. Customer agrees that it will not directly or indirectly export the Evaluation Board to another country, and that it will comply with all applicable United States federal laws and regulations relating to exports. GOVERNING LAW. This Agreement shall be governed by and construed in accordance with the substantive laws of the Commonwealth of Massachusetts (excluding conflict of law rules). Any legal action regarding this Agreement will be heard in the state or federal courts having jurisdiction in Suffolk County, Massachusetts, and Customer hereby submits to the personal jurisdiction and venue of such courts. The United Nations Convention on Contracts for the International Sale of Goods shall not apply to this Agreement and is expressly disclaimed.