



# 60×60×25 mm

San Ace 60L 9LG type

## General Specifications

- Material ..... Frame: Aluminum, Impeller: Plastic (Flammability: UL 94V-1)
- Expected life ..... See the table below. (L10 life: 90% survival rate for continuous operation in free air at 60°C, rated voltage)
- Motor protection function ..... Locked rotor burnout protection, Reverse polarity protection  
For details, please refer to p. 547.
- Dielectric strength ..... 50/60 Hz, 500 VAC, for 1 minute (between lead wire conductors and frame)
- Insulation resistance ..... 10 MΩ or more with a 500 VDC megger (between lead wire conductors and frame)
- Sound pressure level (SPL) ..... At 1 m away from the air inlet
- Storage temperature ..... -30 to +70°C (Non-condensing)
- Lead wire ..... ⊕Red ⊖Black Sensor Yellow Control Brown
- Mass ..... 100 g

## Specifications

The models listed below **have pulse sensors with PWM control function.**

Model no.	Rated voltage [V]	Operating voltage range [V]	PWM duty cycle* [%]	Rated current [A]	Rated input [W]	Rated speed [min <sup>-1</sup> ]	Max. airflow [m <sup>3</sup> /min] [CFM]	Max. static pressure [Pa] [inchH <sub>2</sub> O]	SPL [dB (A)]	Operating temperature [°C]	Expected life [h]	
9LG0612P4S001	12	10.8 to 13.2	100	0.67	8.04	11000	1.4 49.4	300 1.204	53	-20 to +70	180000/60°C	
			20	0.06	0.72	2900	0.36 12.7	20.8 0.083	20			
9LG0612P4J001			100	0.39	4.68	8650	1.1 38.8	182 0.73	47			
			20	0.03	0.36	1150	0.13 4.8	3.3 0.013	14			
9LG0612P4H001			100	0.17	2.04	6150	0.78 27.5	97 0.389	35			
			20	0.03	0.36	1350	0.17 6.0	4.7 0.018	14			
9LG0612P4M001		100	0.09	1.08	4200	0.53 18.7	45 0.18	24				
		20	0.03	0.36	900	0.11 3.8	2.0 0.008	14				
9LG0624P4S001		24	21.6 to 26.4	100	0.34	8.16	11000	1.4 49.4	300 1.204			53
				20	0.03	0.72	2900	0.36 12.7	20.8 0.083			20
9LG0624P4J001				100	0.19	4.56	8650	1.1 38.8	182 0.73			47
				20	0.02	0.48	2200	0.28 9.8	12.0 0.048			17
9LG0624P4H001	100			0.08	1.92	6150	0.78 27.5	97 0.389	35			
	20			0.02	0.48	1300	0.16 5.6	4.3 0.017	14			
9LG0624P4M001	100		0.04	0.96	4200	0.53 18.7	45 0.18	24				
	20		0.01	0.24	800	0.1 3.5	1.6 0.006	14				
9LG0648P4S001	48		36 to 72	100	0.18	8.64	11000	1.4 49.4	305 1.224	53		
				20	0.02	0.96	2900	0.36 12.7	20.8 0.083	20		
9LG0648P4J001				100	0.1	4.8	8650	1.1 38.8	182 0.73	47		
				20	0.02	0.96	2100	0.26 9.1	10.7 0.042	17		
9LG0648P4H001		100		0.06	2.88	6150	0.78 27.5	97 0.389	35			
		20		0.02	0.96	1000	0.12 4.2	2.5 0.01	14			
9LG0648P4M001		100	0.04	1.92	4200	0.53 18.7	45 0.18	24				
		20	0.02	0.96	650	0.08 2.8	1.0 0.004	14				

\* PWM frequency: 25 kHz. Fan does not rotate when PWM duty cycle is 0%.

The following sensor and control options are available for selection.

Differs according to the model. Refer to the table on p. 576. Without sensor Pulse sensor Lock sensor

# Airflow - Static Pressure Characteristics / PWM Duty - Speed Characteristics Example

**9LG0612P4S001** With pulse sensor with PWM control function

PWM duty cycle

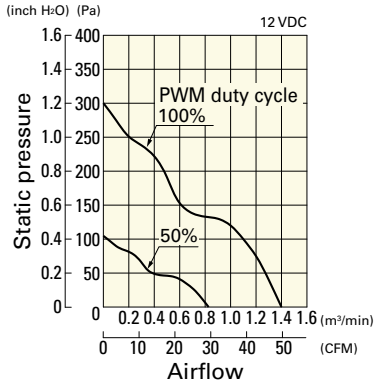

Operating voltage range

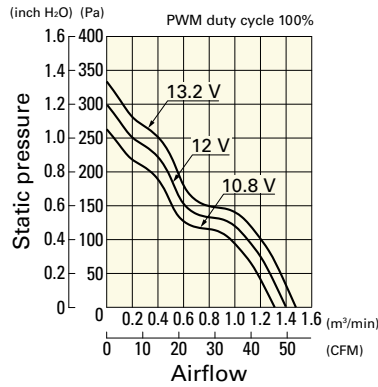

PWM duty - Speed characteristics example

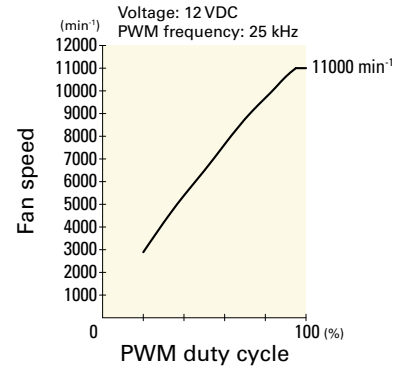

**9LG0612P4J001** With pulse sensor with PWM control function

PWM duty cycle

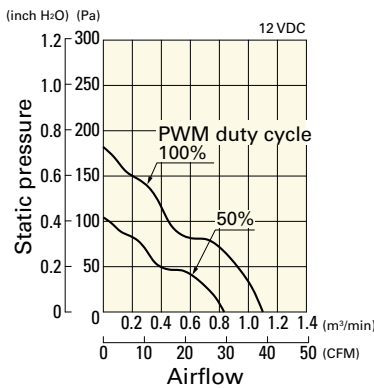

Operating voltage range

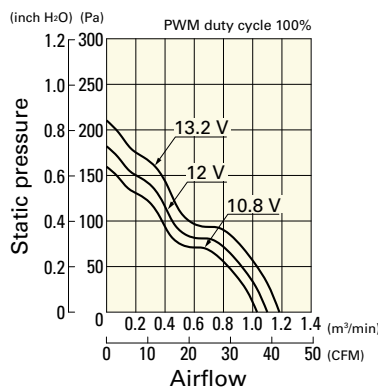

PWM duty - Speed characteristics example

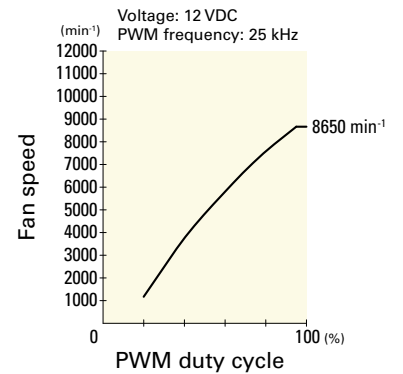

**9LG0612P4H001** With pulse sensor with PWM control function

PWM duty cycle

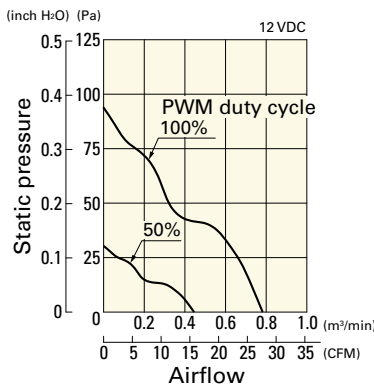

Operating voltage range

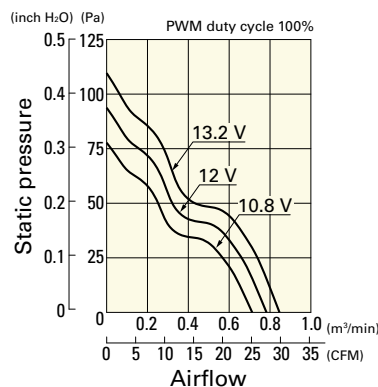

PWM duty - Speed characteristics example

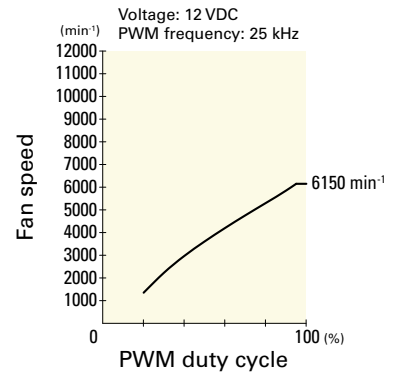

**9LG0612P4M001** With pulse sensor with PWM control function

PWM duty cycle

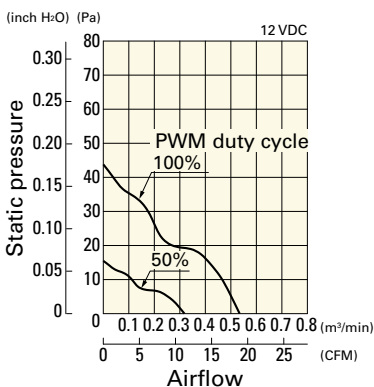

Operating voltage range

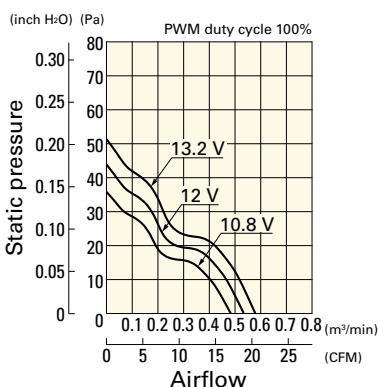

PWM duty - Speed characteristics example

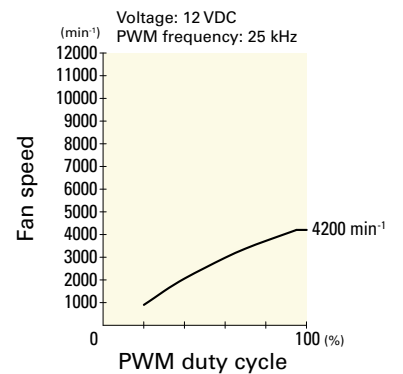

DC

Long Life Fan 60 mm sq.

# Airflow - Static Pressure Characteristics / PWM Duty - Speed Characteristics Example

**9LG0624P4S001** With pulse sensor with PWM control function

PWM duty cycle

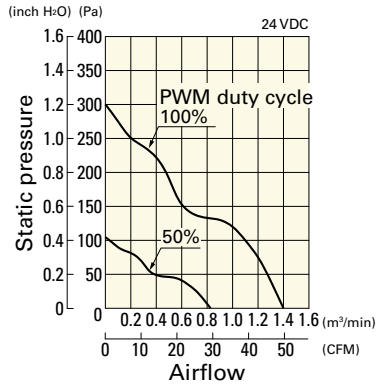

Operating voltage range

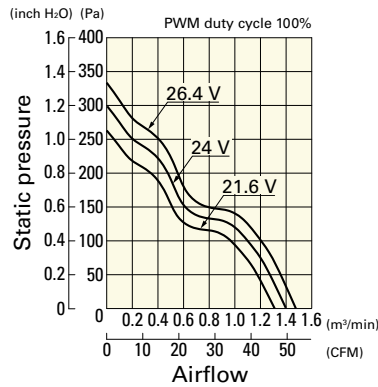

PWM duty - Speed characteristics example

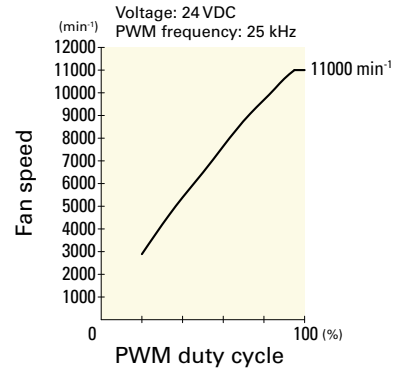

**9LG0624P4J001** With pulse sensor with PWM control function

PWM duty cycle

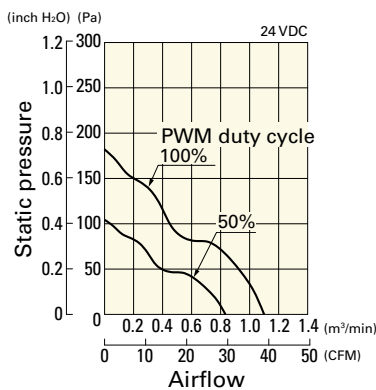

Operating voltage range

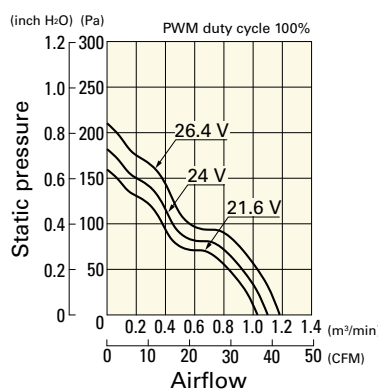

PWM duty - Speed characteristics example

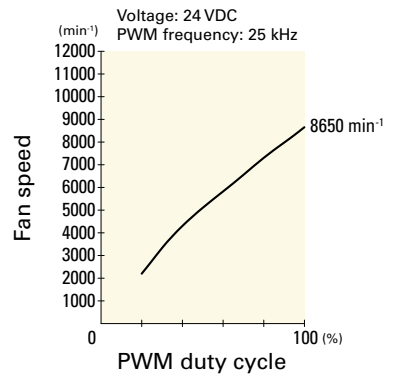

**9LG0624P4H001** With pulse sensor with PWM control function

PWM duty cycle

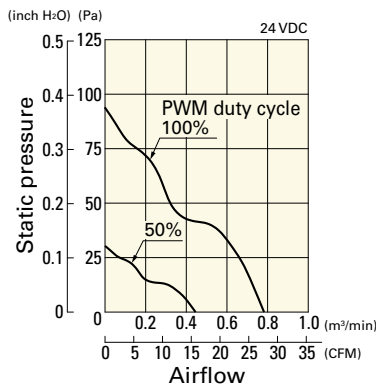

Operating voltage range

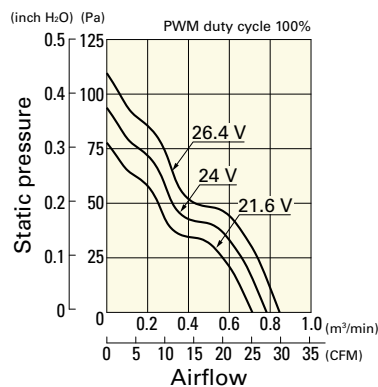

PWM duty - Speed characteristics example

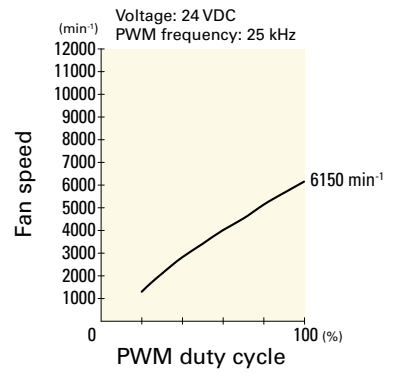

**9LG0624P4M001** With pulse sensor with PWM control function

PWM duty cycle

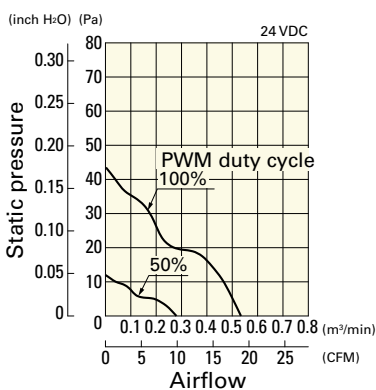

Operating voltage range

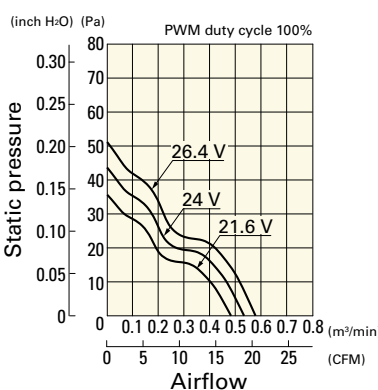

PWM duty - Speed characteristics example

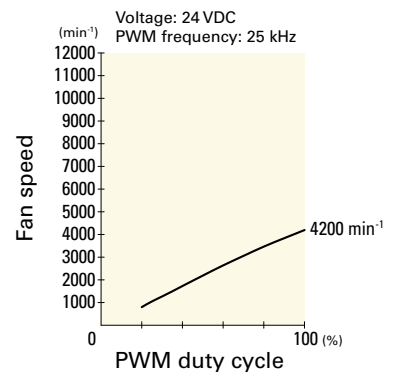

# Airflow - Static Pressure Characteristics / PWM Duty - Speed Characteristics Example

**9LG0648P4S001** With pulse sensor with PWM control function

PWM duty cycle

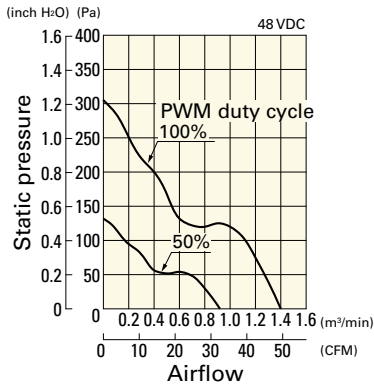

Operating voltage range

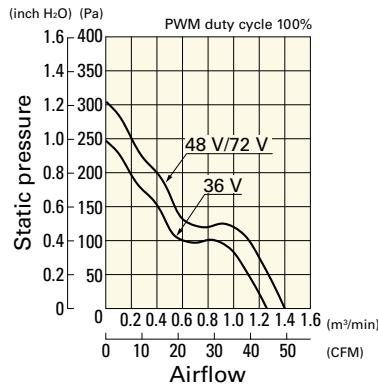

PWM duty - Speed characteristics example

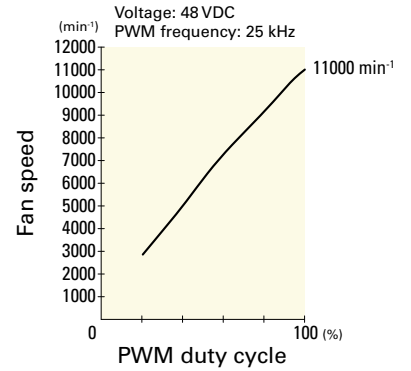

**9LG0648P4J001** With pulse sensor with PWM control function

PWM duty cycle

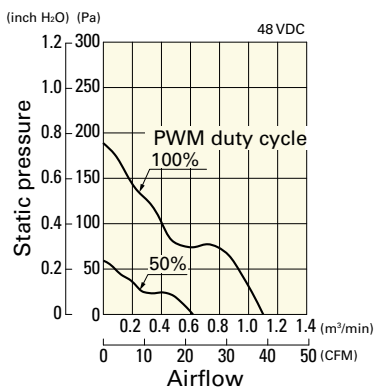

Operating voltage range

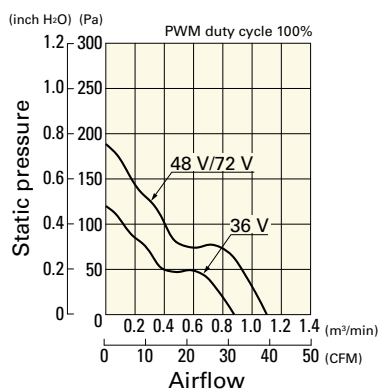

PWM duty - Speed characteristics example

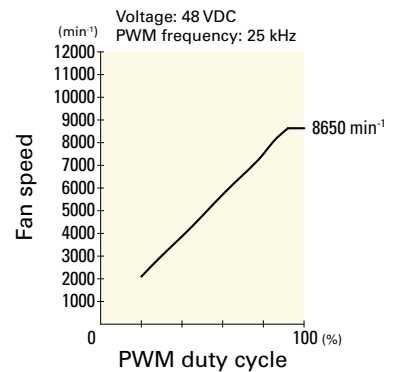

**9LG0648P4H001** With pulse sensor with PWM control function

PWM duty cycle

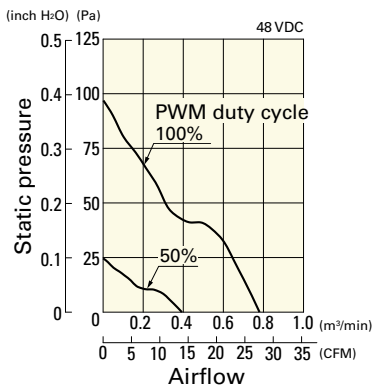

Operating voltage range

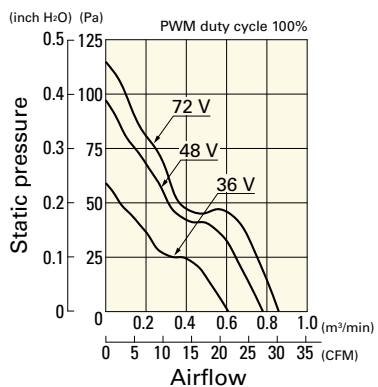

PWM duty - Speed characteristics example

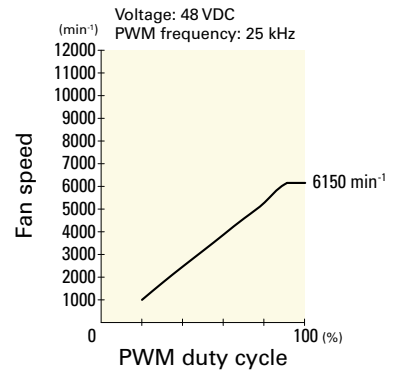

**9LG0648P4M001** With pulse sensor with PWM control function

PWM duty cycle

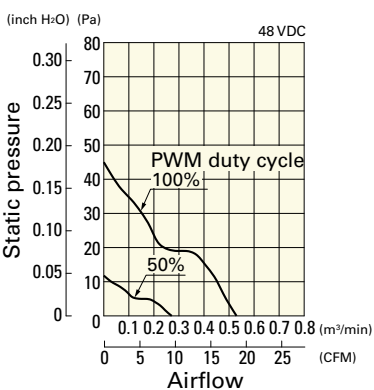

Operating voltage range

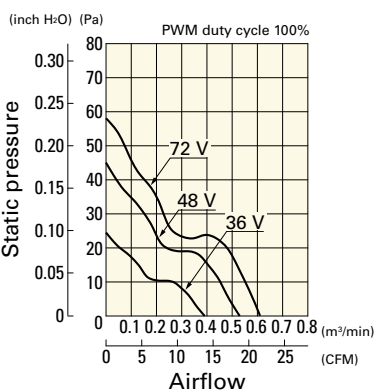

PWM duty - Speed characteristics example

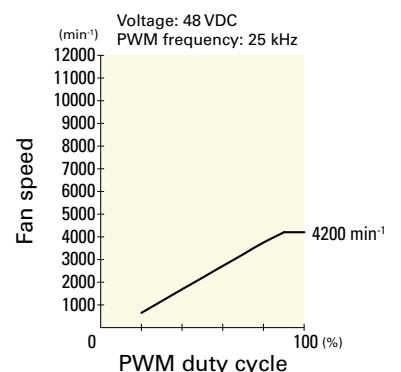

DC

Long Life Fan 60 mm sq.

## Dimensions (unit: mm)

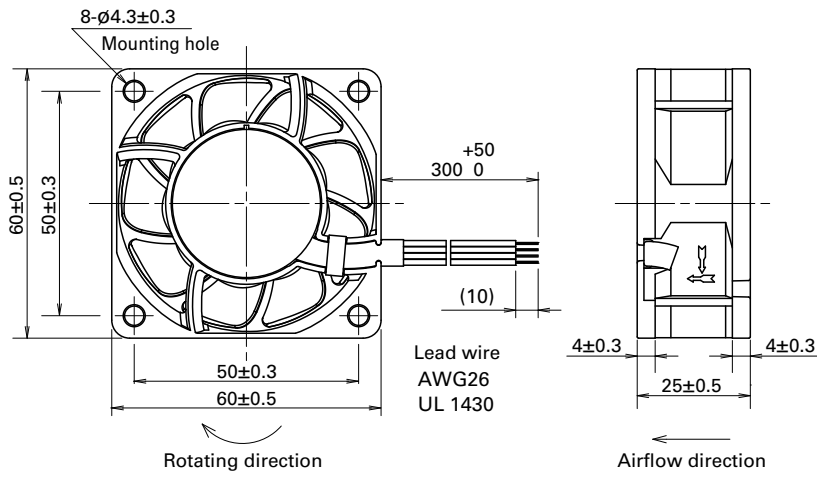

## Reference Dimensions of Mounting Holes and Vent Opening (unit: mm)

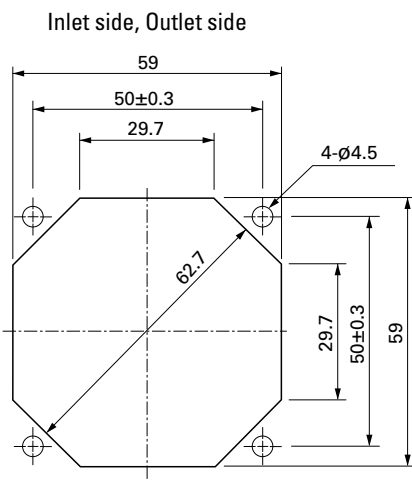

## Options

### Finger guards

page: p. 532

Model no.: 109-139E, 109-139H

### Resin finger guards

page: p. 539

Model no.: 109-1003G

### Resin filter kits

page: p. 540

Model no.: 109-1003F13 (13PPI), 109-1003F20 (20PPI),  
109-1003F30 (30PPI), 109-1003F40 (40PPI)