

Features

- Low Quiescent Current: 5 μ A
- Operating Voltage Range: 2.0V~7.0V
- Low Dropout Voltage: 150mV@150mA
- Output Voltage: 1.2~ 5.0V
- High Accuracy: $\pm 2\%$ (Typ.)
- High Ripple Rejection: 65dB@1kHz
- TTL-Logic-Controlled Shutdown Input
- Excellent Line and Load Transient Response
- Built-in Current Limiter, Short-Circuit Protection
- Epoxy Meets UL 94 V-0 Flammability Rating
- Halogen Free. "Green" Device (Note 1)
- Lead Free Finish/RoHS Compliant ("P" Suffix designates RoHS Compliant. See ordering information)

Applications

- Cellular and Smart Phones
- Radio Control Systems
- Laptop, Palmtops and PDAs
- Digital Still and Video Cameras
- MP3,MP4 Player
- Battery-Powered Equipment

Description

The MC6230 series are a group of positive voltage regulators manufactured by CMOS technologies with high ripple rejection, ultra-low noise, low power consumption and low dropout voltage, which can prolong battery life in portable electronics. The MC6230 series work with low-ESR ceramic capacitors, reducing the amount of board space necessary for power applications. The MC6230 series consume less than 0.1 μ A in shutdown mode and have fast turn-on time less than 50 μ S. The series are very suitable for the battery-powered equipments, such as RF applications and other systems requiring a quiet voltage source.

MCC Part Number	Device Marking
MC6230-1.2	9VBM
MC6230-1.5	B9qYM
MC6230-1.8	9VKM
MC6230-2.5	B9vYM
MC6230-2.8	9VXM
MC6230-3.0	B9zYM
MC6230-3.3	9A2M
MC6230-3.6	9A5M

Note:

1. Halogen free "Green" products are defined as those which contain <900ppm bromine, <900ppm chlorine (<1500ppm total Br + Cl) and <1000ppm antimony compounds.

Low Consumption Current High PSRR 300mA CMOS Voltage Regulators

SOT23-5L

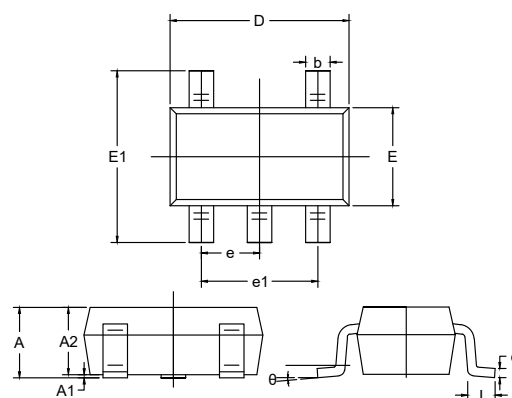

DIM	INCHES		MM		NOTE
	MIN	MAX	MIN	MAX	
A	0.041	0.049	1.05	1.25	
A1	0.000	0.004	0.00	0.10	
A2	0.041	0.045	1.05	1.15	
b	0.012	0.020	0.30	0.50	
c	0.004	0.008	0.10	0.20	
D	0.111	0.119	2.82	3.02	
E	0.059	0.067	1.50	1.70	
E1	0.104	0.116	2.65	2.95	
e	0.037(BSC)		0.950(BSC)		
e1	0.071	0.079	1.80	2.00	
L	0.012	0.024	0.30	0.60	
θ	0°	8°	0°	8°	

Suggested Solder Pad Layout

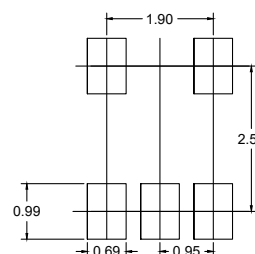

Functional Block Diagram

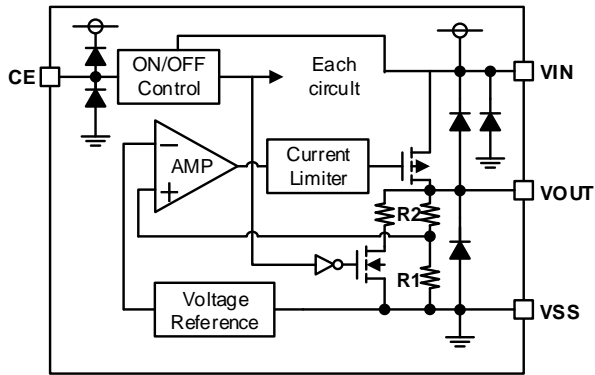

Pin Configuration and Functions (Top View)

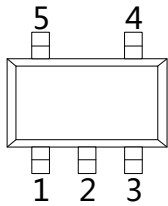

Number	Name	Function
1	V_{IN}	Power Input Pin
2	V_{SS}	Ground
3	CE	Chip Enable Pin
4	NC	No Connection
5	V_{OUT}	Output Pin

Typical Application Circuit

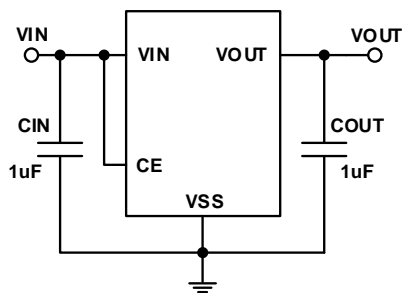

Absolute Maximum Ratings

- Input Voltage: $V_{SS}-0.3V \sim V_{SS}+8V$
- Output Voltage: $V_{SS}-0.3V \sim V_{IN}+0.3V$
- Output Current: 300mA
- Power Dissipation: 500mW
- Operating Free Air Temperature Range: $-40\sim+85^{\circ}C$
- Operating Junction Temperature Range: $-40\sim+125^{\circ}C$
- Storage Temperature Range: $-40\sim+125^{\circ}C$
- Lead Temperature & Time: $260^{\circ}C, 10s$

Electrical Characteristics

($V_{IN}=V_{OUT}+1V, C_{IN}=C_{OUT}=1\mu F, T_A=25^{\circ}C$, unless otherwise specified)

Parameter	Symbol	Conditions	Min.	Typ.	Max.	Units
Output Voltage	$V_{OUT(E)}^{(1)}$	$I_{OUT}=1mA$	$V_{OUT} * 0.98$	V_{OUT}	$V_{OUT} * 1.02$	V
Supply Current	I_{SS}	$I_{OUT}=0$		5	10	μA
Standby Current	I_{STBY}	$CE = V_{SS}$			0.1	μA
Output Current	I_{OUT}	—	300			mA
Dropout Voltage ⁽²⁾	V_{dif}	$I_{OUT} = 150mA$ $V_{OUT} \geq 3.0V$		150		mV
Load Regulation	ΔV_{OUT}	$V_{IN} = V_{OUT} + 1V,$ $1mA \leq I_{OUT} \leq 100mA$		10		mV
Line Regulation	$\frac{\Delta V_{OUT}}{V_{OUT} \times \Delta V_{IN}}$	$I_{OUT} = 10mA$ $V_{OUT} + 1V \leq V_{IN} \leq 6V$		0.01	0.2	%/V
Output Voltage Temperature Characteristics	$\frac{\Delta V_{OUT}}{\Delta T \times V_{OUT}}$	$I_{OUT} = 10mA$ $-40 \leq T \leq +85$		100		ppm
Short Current	I_{Short}	$V_{OUT} = V_{SS}$		50		mA
Input Voltage	V_{IN}	—	2.0		7.0	V
Power Supply Rejection Rate	1kHz	PSRR	$I_{OUT}=50mA$		65	dB
	10kHz				50	
CE "High" Voltage	$V_{CE} "H"$		1.5		V_{IN}	V
CE "Low" Voltage	$V_{CE} "L"$				0.3	V

Note:

1. $V_{OUT(E)}$: Effective Output Voltage (i.e. The output voltage when $V_{IN}=(V_{OUT} + 1.0V)$ and maintain a certain I_{OUT} Value).
2. V_{dif} : The Difference Of Output Voltage And Input Voltage When Input Voltage Is Decreased Gradually Till Output Voltage Equals To 98% Of $V_{OUT(E)}$.

Curve Characteristics

Output Characteristics

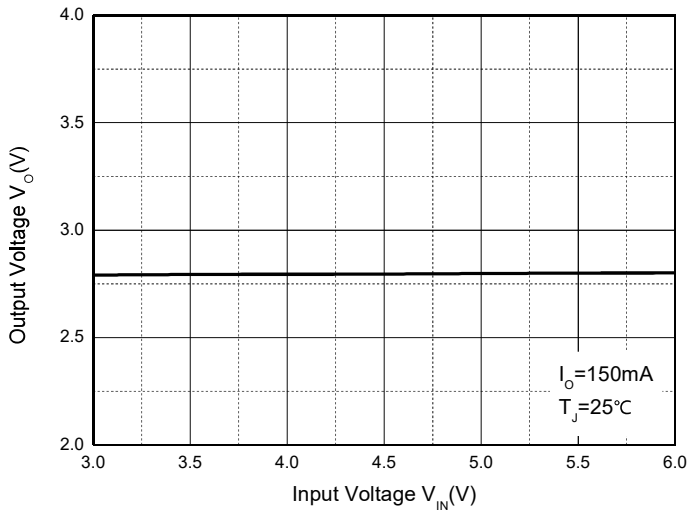

Output Voltage vs. Temperature

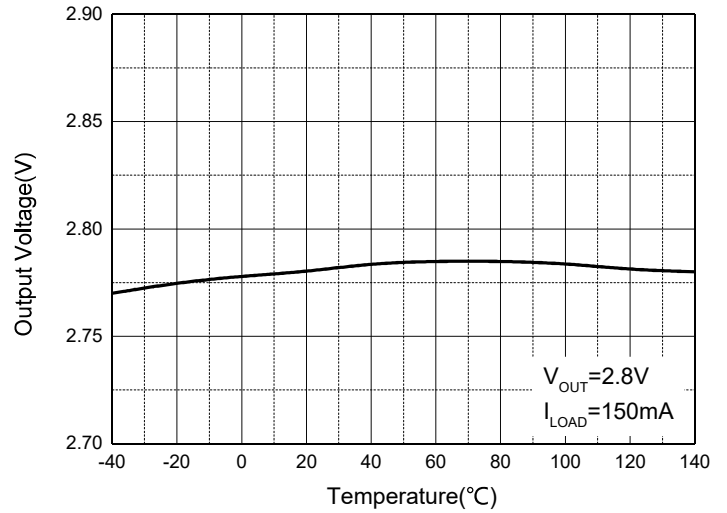

Quiescent Current

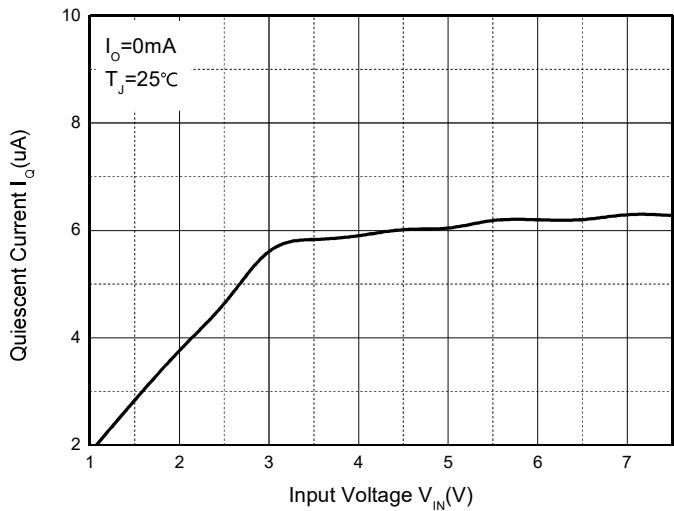

Current Cut-off Grid Voltage

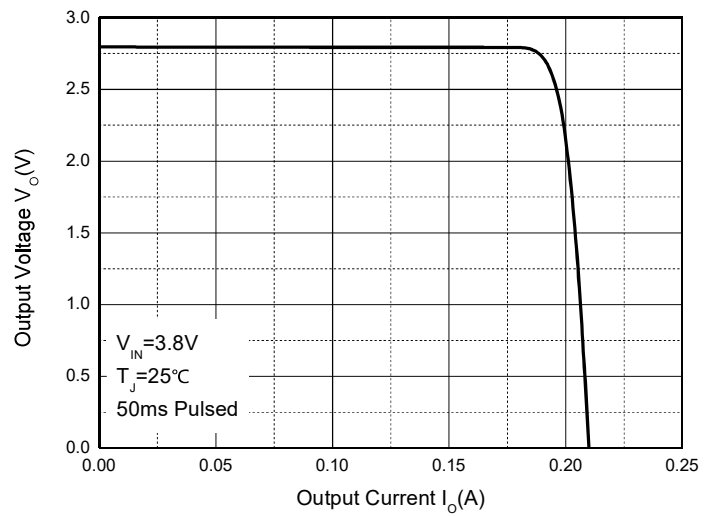

Dropout Voltage vs. Load Current

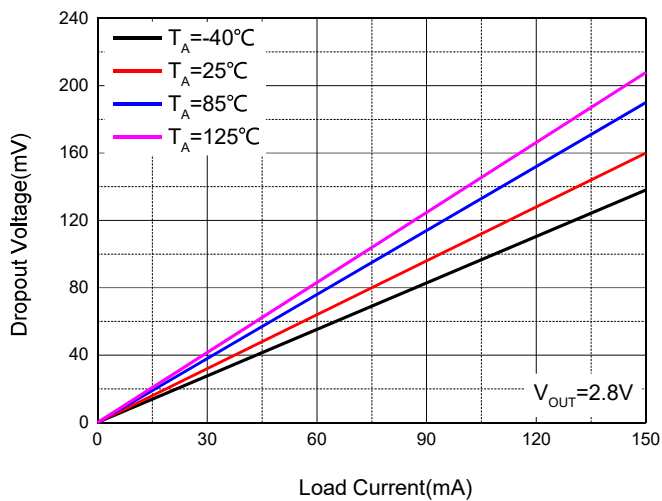

PSRR vs. Frequency

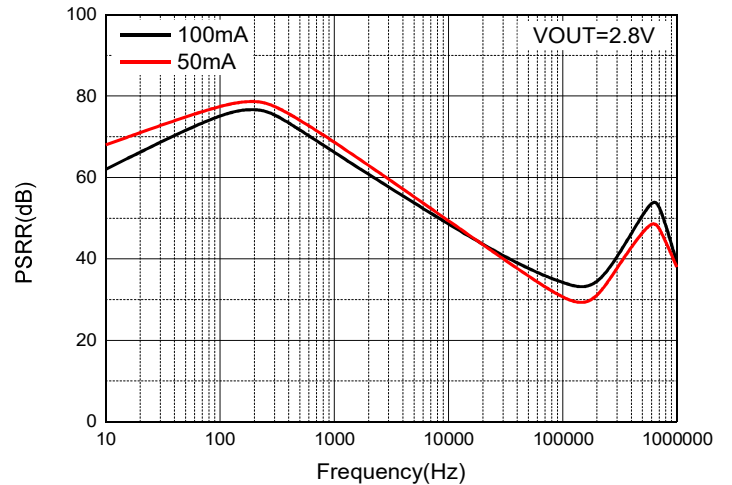

Ordering Information

Device	Packing
Part Number-TP	Tape&Reel: 3Kpcs/Reel

*****IMPORTANT NOTICE*****

Micro Commercial Components Corp. reserves the right to make changes without further notice to any product herein to make corrections, modifications, enhancements, improvements, or other changes. **Micro Commercial Components Corp.** does not assume any liability arising out of the application or use of any product described herein; neither does it convey any license under its patent rights, nor the rights of others. The user of products in such applications shall assume all risks of such use and will agree to hold **Micro Commercial Components Corp.** and all the companies whose products are represented on our website, harmless against all damages. **Micro Commercial Components Corp.** products are sold subject to the general terms and conditions of commercial sale, as published at <https://www.mccsemi.com/Home/TermsAndConditions>.

*****LIFE SUPPORT*****

MCC's products are not authorized for use as critical components in life support devices or systems without the express written approval of Micro Commercial Components Corporation.

*****CUSTOMER AWARENESS*****

Counterfeiting of semiconductor parts is a growing problem in the industry. Micro Commercial Components (MCC) is taking strong measures to protect ourselves and our customers from the proliferation of counterfeit parts. MCC strongly encourages customers to purchase MCC parts either directly from MCC or from Authorized MCC Distributors who are listed by country on our web page cited below. Products customers buy either from MCC directly or from Authorized MCC Distributors are genuine parts, have full traceability, meet MCC's quality standards for handling and storage. **MCC will not provide any warranty coverage or other assistance for parts bought from Unauthorized Sources.** MCC is committed to combat this global problem and encourage our customers to do their part in stopping this practice by buying direct or from authorized distributors.